

FEATURES

- Dual independent, digitally controlled VGAs**
- 11.5 dB to +20 dB gain range**
- 0.5 dB \pm 0.1 dB step size**
- 150 Ω differential input and output**
- 7.5 dB noise figure at maximum gain**
- OIP3 > 50 dBm at 200 MHz**
- 3 dB upper frequency bandwidth of 700 MHz**
- Multiple control interface options**
- Parallel 6-bit control interface (with latch)**
- Serial peripheral interface (SPI) (with fast attack)**
- Gain up/down mode**
- Wide input dynamic range**
- Low power mode option**
- Power-down control**
- Single 5 V supply operation**
- 40-lead, 6 mm \times 6 mm LFCSP package**

APPLICATIONS

- Differential ADC drivers**
- High IF sampling receivers**
- High output power IF amplification**
- Instrumentation**

GENERAL DESCRIPTION

The **ADL5202** is a digitally controlled, variable gain, wide bandwidth amplifier that provides precise gain control, high output IP3, and low noise figure. The excellent distortion performance and high signal bandwidth make the **ADL5202** an excellent gain control device for a variety of receiver applications. The **ADL5202** also incorporates a low power mode option that lowers the supply current.

For wide input dynamic range applications, the **ADL5202** provides a broad 31.5 dB gain range with 0.5 dB resolution. The gain is adjustable through multiple gain control interface options: parallel, serial peripheral interface, and up/down.

Incorporating proprietary distortion cancellation techniques, the **ADL5202** achieves a better than 50 dBm output IP3 at frequencies approaching 200 MHz for most gain settings.

FUNCTIONAL BLOCK DIAGRAM

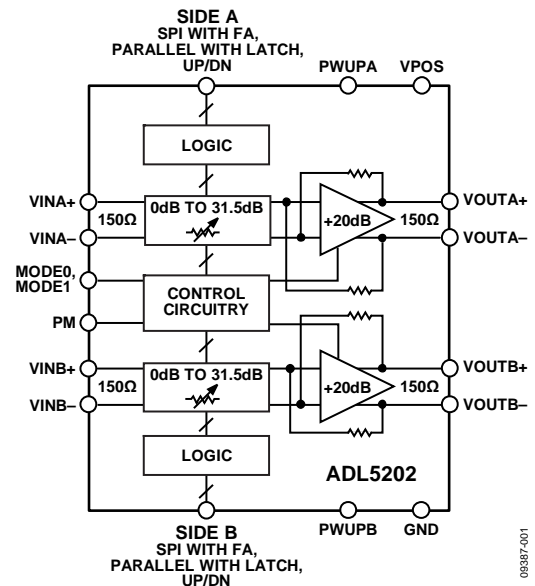

Figure 1.

The **ADL5202** is powered on by applying the appropriate logic level to the PWUPx pins. The quiescent current of the **ADL5202** is typically 160 mA in low power mode. When configured in high performance mode for more demanding applications, the quiescent current is 210 mA. When powered down, the **ADL5202** consumes less than 14 mA and offers excellent input-to-output isolation. The gain setting is preserved during power-down.

Fabricated on an Analog Devices, Inc., high speed SiGe process, the **ADL5202** provides precise gain adjustment capabilities with good distortion performance and low phase error. The **ADL5202** amplifier comes in a compact, thermally enhanced 40-lead, 6 mm \times 6 mm LFCSP package and operates over a temperature range of -40°C to $+85^{\circ}\text{C}$.

TABLE OF CONTENTS

Features	1	Gain Up/Down Interface.....	16
Applications.....	1	Truth Table	17
Functional Block Diagram	1	Logic Timing.....	17
General Description	1	Circuit Description.....	18
Revision History	2	Basic Structure.....	18
Specifications.....	3	Applications Information	19
Absolute Maximum Ratings.....	5	Basic Connections.....	19
ESD Caution.....	5	ADC Driving.....	19
Pin Configuration and Function Descriptions.....	6	Layout Considerations.....	21
Typical Performance Characteristics	8	Evaluation Board	22
Characterization and Test Circuits.....	15	Evaluation Board Control Software.....	22
Theory of Operation	16	Evaluation Board Schematics and Artwork.....	23
Digital Interface Overview	16	Evaluation Board Configuration Options.....	27
Parallel Digital Interface	16	Outline Dimensions	29
Serial Peripheral Interface (SPI).....	16	Ordering Guide	29

REVISION HISTORY

9/13—Rev. A to Rev. B

Changed Logic Pins Absolute Maximum Rating from 3.6 V to -0.3 V to +3.6 V (not to exceed $|V_{POS} - 0.5 V|$ at any time).... 5

12/12—Rev. 0 to Rev. A

Changes to Layout Consideration Section

10/11—Revision 0: Initial Version

SPECIFICATIONS

$V_S = 5\text{ V}$, $T_A = 25^\circ\text{C}$, $R_S = R_L = 150\ \Omega$ at 100 MHz, high performance mode, 2 V p-p differential output, unless otherwise noted.

Table 1.

Parameter	Test Conditions/Comments	Min	Typ	Max	Unit
DYNAMIC PERFORMANCE					
–3 dB Bandwidth	$V_{OUT} < 2\text{ V p-p}$ (5.2 dBm)		700		MHz
Slew Rate			5.5		V/ns
Input Return Loss (S11)	100 MHz		–17.7		dB
Output Return Loss (S22)	100 MHz		–16.5		dB
INPUT STAGE					
Maximum Input Swing (Differential)	VINA+, VINB+ and VINA–, VINB– pins Gain code = 111111		10.8		V p-p
Differential Input Resistance			150		Ω
Common-Mode Input Voltage			1.5		V
CMRR	Gain code = 000000		40		dB
GAIN					
Maximum Voltage Gain	Gain code = 000000		20		dB
Minimum Voltage Gain	Gain code = 111111		–11.5		dB
Gain Step Size			0.5		dB
Gain Flatness	$30\text{ MHz} < f_C < 200\text{ MHz}$		0.285		dB
Gain Temperature Sensitivity	Gain code = 000000		0.012		dB/°C
Gain Step Response	For $V_{IN} = 0.2\text{ V}$, gain code = 111111 to 000000		15		ns
Gain Conformance Error	Over 10 dB gain range		± 0.03		dB
Phase Conformance Error	Over 10 dB gain range		1.0		Degrees
OUTPUT STAGE					
Output Voltage Swing	VOUTx+ and VOUTx– pins At P1dB, gain code = 000000		10		V p-p
Differential Output Resistance	Differential		150		Ω
NOISE/HARMONIC PERFORMANCE					
46 MHz					
Second Harmonic	Gain code = 000000, high performance mode $V_{OUT} = 2\text{ V p-p}$		–92		dBc
Third Harmonic	$V_{OUT} = 2\text{ V p-p}$		–105		dBc
Output IP3	$V_{OUT} = 2\text{ V p-p}$ composite		50		dBm
70 MHz					
Second Harmonic	Gain code = 000000, high performance mode $V_{OUT} = 2\text{ V p-p}$		–96		dBc
Third Harmonic	$V_{OUT} = 2\text{ V p-p}$		–105		dBc
Output IP3	$V_{OUT} = 2\text{ V p-p}$ composite		50		dBm
140 MHz					
Noise Figure	Gain code = 000000, high performance mode		7.5		dB
Second Harmonic	$V_{OUT} = 2\text{ V p-p}$		–86		dBc
Third Harmonic	$V_{OUT} = 2\text{ V p-p}$		–105		dBc
Output IP3	$V_{OUT} = 2\text{ V p-p}$ composite		50		dBm
Output 1 dB Compression Point			19.5		dBm
300 MHz					
Second Harmonic	Gain code = 000000, high performance mode $V_{OUT} = 2\text{ V p-p}$		–77		dBc
Third Harmonic	$V_{OUT} = 2\text{ V p-p}$		–91		dBc
Output IP3	$V_{OUT} = 2\text{ V p-p}$ composite		47		dBm

Parameter	Test Conditions/Comments	Min	Typ	Max	Unit
POWER-UP INTERFACE	PWUPA, PWUPB pins				
Power-Up Threshold	Minimum voltage to enable the device	1.4			V
PWUPx Input Bias Current	Maximum voltage to enable the device		1	3.3	μ A
GAIN CONTROL INTERFACE					
V _{IH}	Minimum/Maximum voltage for a logic high	1.4		3.3	V
V _{IL}	Maximum voltage for a logic low			0.8	V
Maximum Input Bias Current			1		μ A
SPI TIMING	LATCHA and LATCHB, SCLK, SDIO, data pins				
f _{SCLK}	1/t _{SCLK}		20		MHz
t _{DH}	Data hold time		5		ns
t _{DS}	Data setup time		5		ns
t _{PW}	SCLK high pulse width		5		ns
POWER INTERFACE					
Supply Voltage		4.5		5.5	V
Quiescent Current, Both Channels	High performance mode		210		mA
	T _A = 85°C			250	mA
	Low power mode		160		mA
	T _A = 85°C			180	mA
Power-Down Current, Both Channels	PWUPx low		14		mA

Timing Diagrams

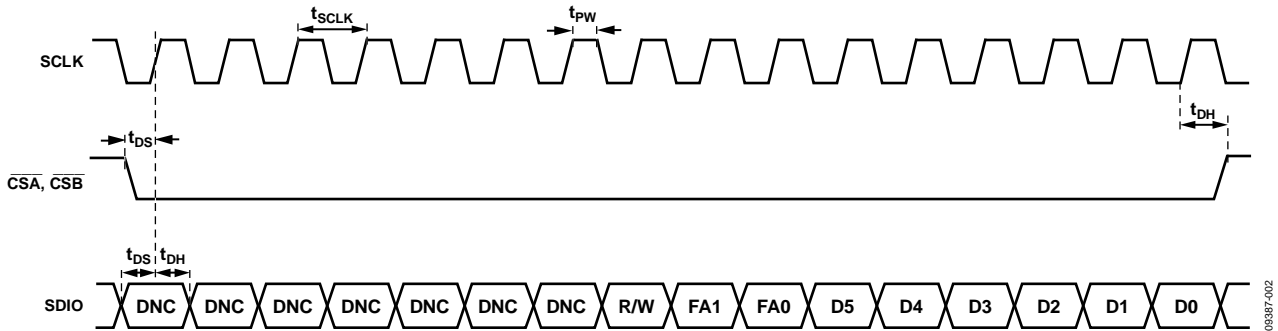

Figure 2. SPI Interface Read/Write Mode Timing Diagram

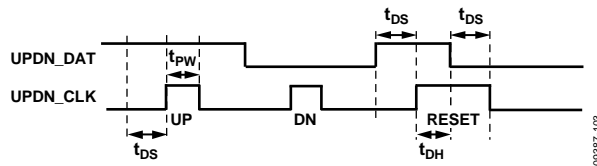

Figure 3. Up/Down Mode Timing Diagram

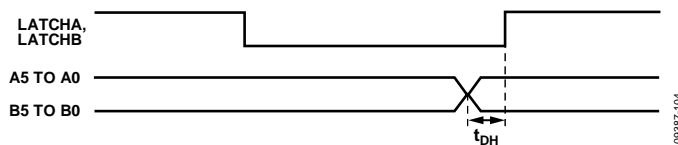

Figure 4. Parallel Mode Timing Diagram

ABSOLUTE MAXIMUM RATINGS

Table 2.

Parameter	Rating
Supply Voltage, V_{POS}	5.5
PWUPA, PWUPB, A0 to A5, B0 to B5, MODE0, MODE1, PM, LATCHA, LATCHB	-0.3 V to +3.6 V (not to exceed $ V_{POS} - 0.5 V $ at any time)
Input Voltage, V_{IN+} , V_{IN-}	+3.6 V to -1.2 V
Internal Power Dissipation	1.6 W
θ_{JA} (Exposed Paddle Soldered Down)	34.6°C/W
θ_{JC} (At Exposed Paddle)	3.6°C/W
Maximum Junction Temperature	140°C
Operating Temperature Range	-40°C to +85°C
Storage Temperature Range	-65°C to +150°C
Lead Temperature (Soldering, 60 sec)	240°C

Stresses above those listed under Absolute Maximum Ratings may cause permanent damage to the device. This is a stress rating only; functional operation of the device at these or any other conditions above those indicated in the operational section of this specification is not implied. Exposure to absolute maximum rating conditions for extended periods may affect device reliability.

ESD CAUTION



ESD (electrostatic discharge) sensitive device. Charged devices and circuit boards can discharge without detection. Although this product features patented or proprietary protection circuitry, damage may occur on devices subjected to high energy ESD. Therefore, proper ESD precautions should be taken to avoid performance degradation or loss of functionality.

PIN CONFIGURATION AND FUNCTION DESCRIPTIONS

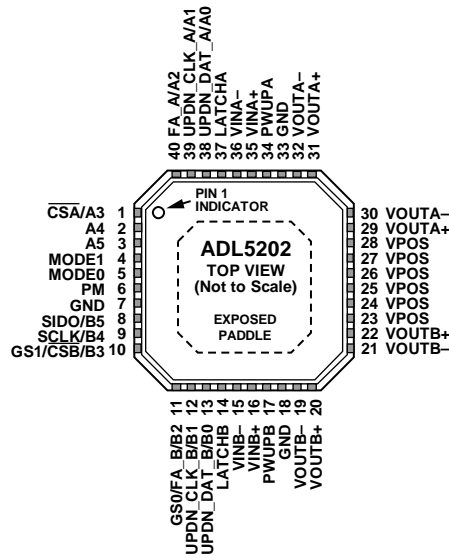

- NOTES**
1. NC = NO CONNECT.
 2. THE EXPOSED PADDLE (EP) MUST BE CONNECTED TO A LOW IMPEDANCE GROUND PAD.

09387-003

Figure 5. Pin Configuration

Table 3. Pin Function Descriptions

Pin No.	Mnemonic	Description
1	CSA/A3	Channel A Select (\overline{CSA}). When serial mode is enabled, a logic low ($0V \leq \overline{CSA} \leq 0.8V$) selects Channel A. Bit 3 for Channel A Parallel Gain Control Interface (A3).
2	A4	Bit 4 for Channel A Parallel Gain Control Interface.
3	A5	Bit 5 (MSB) for Channel A Parallel Gain Control Interface.
4	MODE1	MSB for Mode Control. With the MODE0 pin, selects parallel, SPI, or up/down interface mode.
5	MODE0	LSB for Mode Control. With the MODE1 pin, selects parallel, SPI, or up/down interface mode.
6	PM	Performance Mode. A logic low ($0V \leq PM \leq 0.8V$) enables high performance mode. A logic high ($1.4V \leq PM \leq 3.3V$) enables low power mode.
7, 18, 33, EP	GND	Ground. The exposed paddle (EP) must be connected to a low impedance ground pad.
8	SDIO/B5	Serial Data Input/Output (SDIO). When \overline{CSA} or \overline{CSB} is pulled low, SDIO is used for reading and writing to the SPI port. Bit 5 for Channel B Parallel Gain Control Interface (B5).
9	SCLK/B4	Serial Clock Input in SPI Mode (SCLK). Bit 4 for Channel B Parallel Gain Control Interface (B4).
10	GS1/ \overline{CSB} /B3	MSB for Gain Step Size Control in Up/Down Mode (GS1). Channel B Select (\overline{CSB}). When serial mode is enabled, a logic low ($0V \leq \overline{CSB} \leq 0.8V$) selects Channel B. Bit 3 for Channel B Parallel Gain Control Interface (B3).
11	GS0/FA_B/B2	LSB for Gain Step Size Control in Up/Down Mode (GS0). Fast Attack (FA_B). In serial mode, a logic high ($1.4V \leq FA_B \leq 3.3V$) attenuates Channel B according to the FA setting in the SPI word. Bit 2 for Channel B Parallel Gain Control Interface (B2).
12	UPDN_CLK_B/B1	Clock Interface for Channel B Up/Down Function (UPDN_CLK_B). Bit 1 for Channel B Parallel Gain Control Interface (B1).
13	UPDN_DAT_B/B0	Data Pin for Channel B Up/Down Function (UPDN_DAT_B). Bit 0 for Channel B Parallel Gain Control Interface (B0).
14	LATCHB	Channel B Latch. A logic low ($0V \leq LATCHB \leq 0.8V$) allows gain changes on Channel B. A logic high ($1.4V \leq LATCHB \leq 3.3V$) prevents gain changes on Channel B.

Pin No.	Mnemonic	Description
15	VINB-	Channel B Negative Input.
16	VINB+	Channel B Positive Input.
17	PWUPB	Channel B Power-Up. A logic high ($1.4\text{ V} \leq \text{PWUPB} \leq 3.3\text{ V}$) enables Channel B.
19, 21	VOUTB-	Channel B Negative Output.
20, 22	VOUTB+	Channel B Positive Output.
23, 24, 25, 26, 27, 28	VPOS	Positive Power Supply.
29, 31	VOUTA+	Channel A Positive Output.
30, 32	VOUTA-	Channel A Negative Output.
34	PWUPA	Channel A Power-Up. A logic high ($1.4\text{ V} \leq \text{PWUPA} \leq 3.3\text{ V}$) enables Channel A.
35	VINA+	Channel A Positive Input.
36	VINA-	Channel A Negative Input.
37	LATCHA	Channel A Latch. A logic low ($0\text{ V} \leq \text{LATCHA} \leq 0.8\text{ V}$) allows gain changes on Channel A. A logic high ($1.4\text{ V} \leq \text{LATCHA} \leq 3.3\text{ V}$) prevents gain changes on Channel A.
38	UPDN_DAT_A/A0	Data Pin for Channel A Up/Down Function (UPDN_DAT_A). Bit 0 for Channel A Parallel Gain Control Interface (A0).
39	UPDN_CLK_A/A1	Clock Interface for Channel A Up/Down Function (UPDN_CLK_A). Bit 1 for Channel A Parallel Gain Control Interface (A1).
40	FA_A/A2	Fast Attack (FA_A). In serial mode, a logic high ($1.4\text{ V} \leq \text{FA}_A \leq 3.3\text{ V}$) attenuates Channel A according to FA setting in the SPI word. Bit 2 for Channel A Parallel Gain Control Interface (A2).

TYPICAL PERFORMANCE CHARACTERISTICS

$V_S = 5\text{ V}$, $T_A = 25^\circ\text{C}$, $R_S = R_L = 150\ \Omega$ at 200 MHz, high performance mode, 2 V p-p differential output, unless otherwise noted.

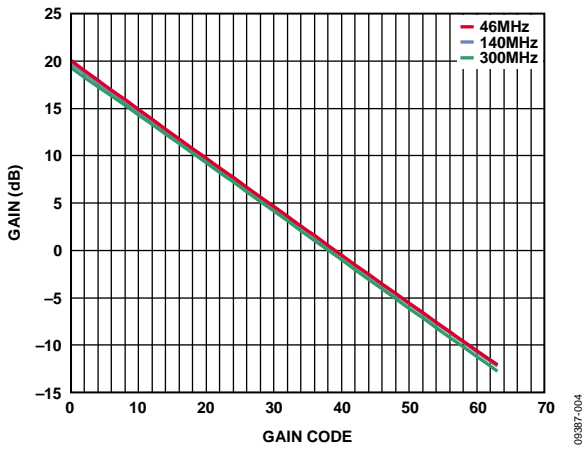

Figure 6. Gain vs. Gain Code at 46 MHz, 140 MHz, and 300 MHz

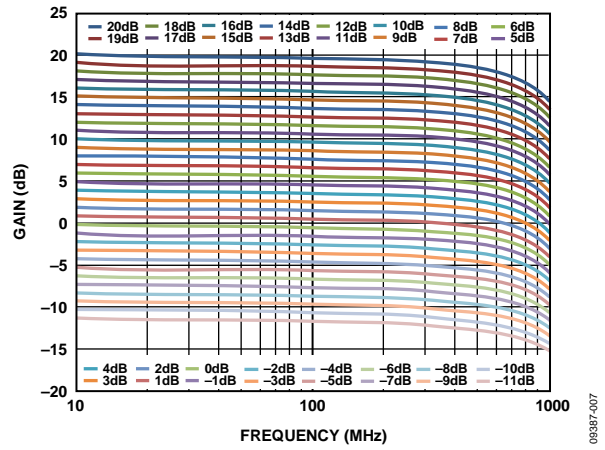

Figure 9. Gain vs. Frequency Response (Every 1 dB Step)

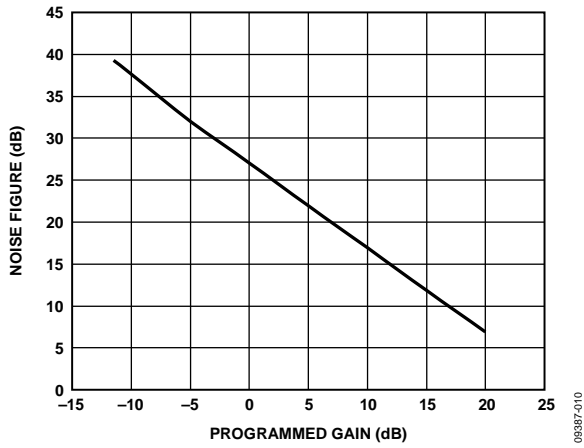

Figure 7. Noise Figure vs. Programmed Gain at 140 MHz

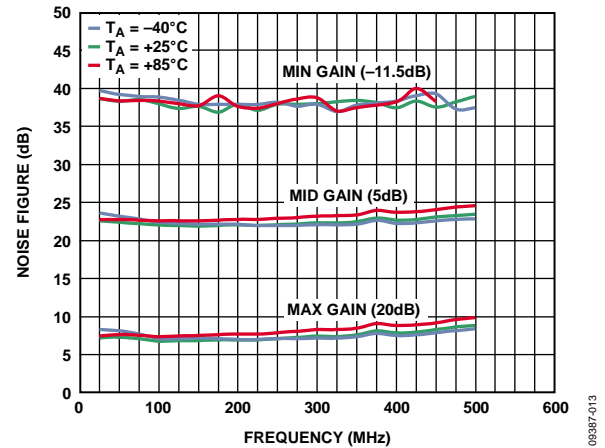

Figure 10. Noise Figure vs. Frequency at Max, Mid, and Min Gain Outputs

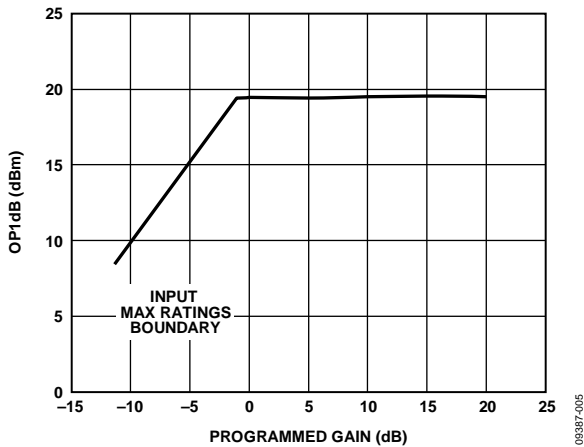

Figure 8. OP1dB vs. Programmed Gain at 140 MHz

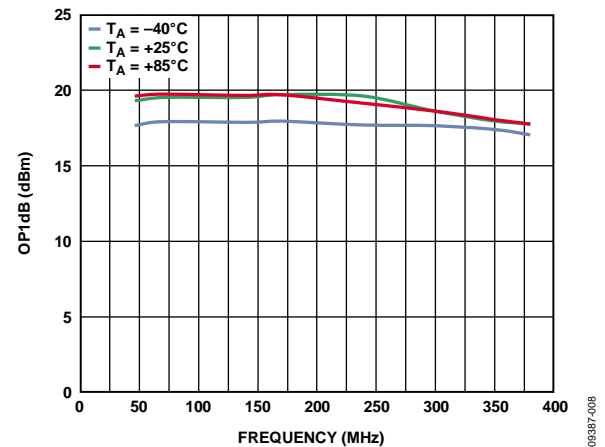

Figure 11. OP1dB vs. Frequency at Maximum Gain, Three Temperatures

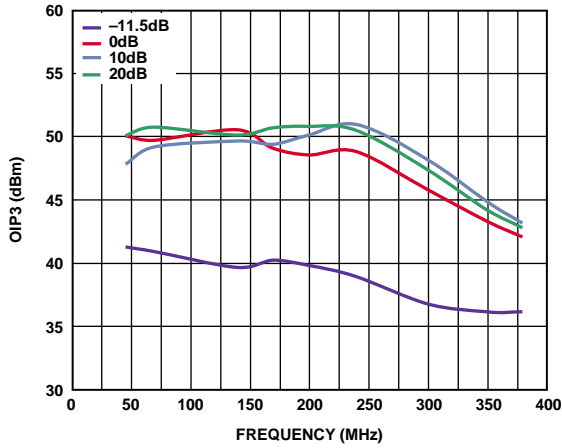

Figure 12. Output Third-Order Intercept vs. Frequency at Four Gain Codes

09387-011

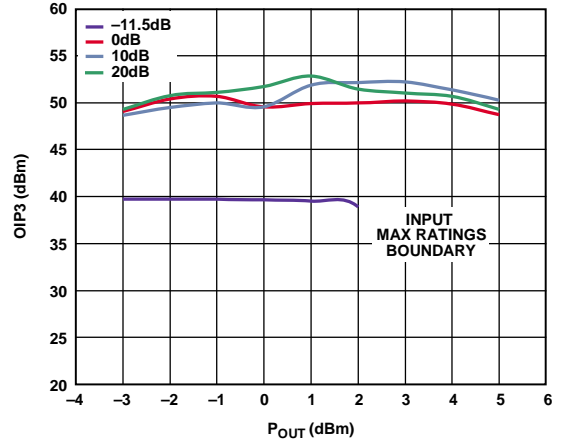

Figure 15. Output Third-Order Intercept vs. Power at Four Gain Codes, Frequency = 140 MHz at 2 Vp-p Composite

09387-014

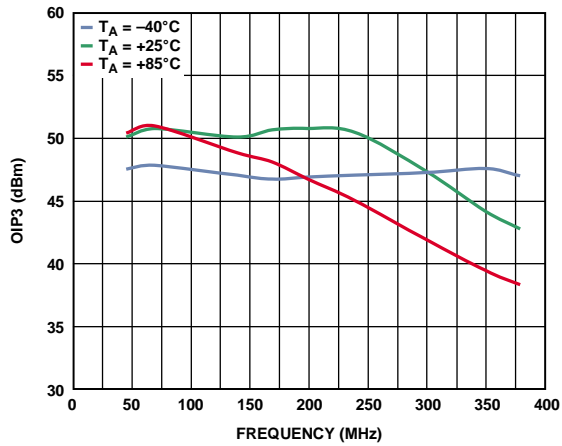

Figure 13. Output Third-Order Intercept vs. Frequency, Three Temperatures at 2 Vp-p Composite

09387-016

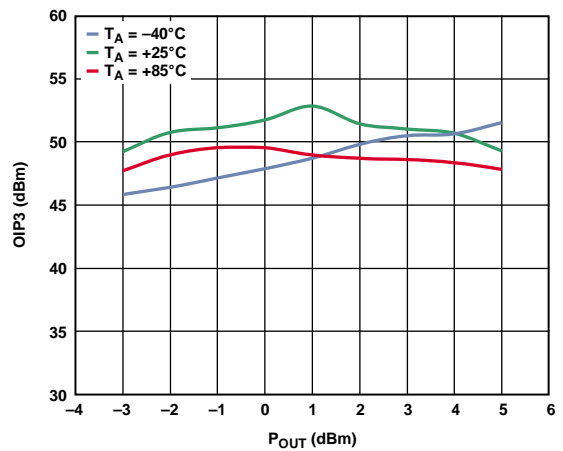

Figure 16. Output Third-Order Intercept vs. Power, Frequency = 140 MHz, Three Temperatures

09387-019

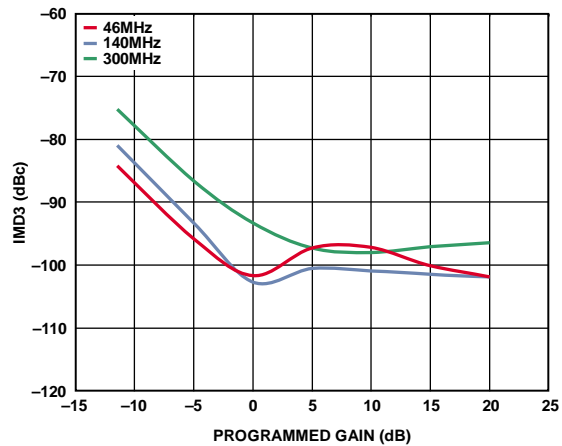

Figure 14. Two-Tone Output IMD3 vs. Programmed Gain, at 46 MHz, 140 MHz, 300 MHz

09387-018

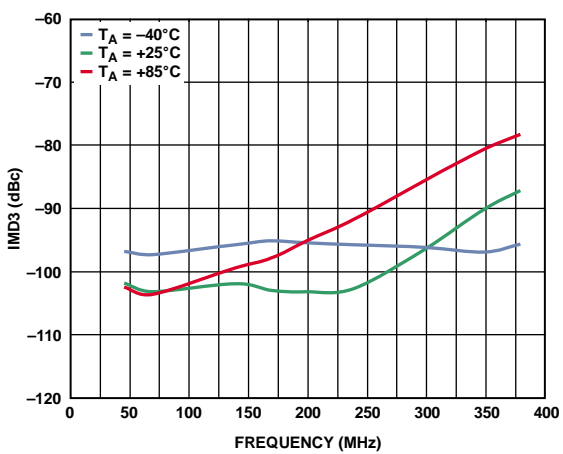

Figure 17. Two-Tone Output IMD3 vs. Frequency, Three Temperatures

09387-021

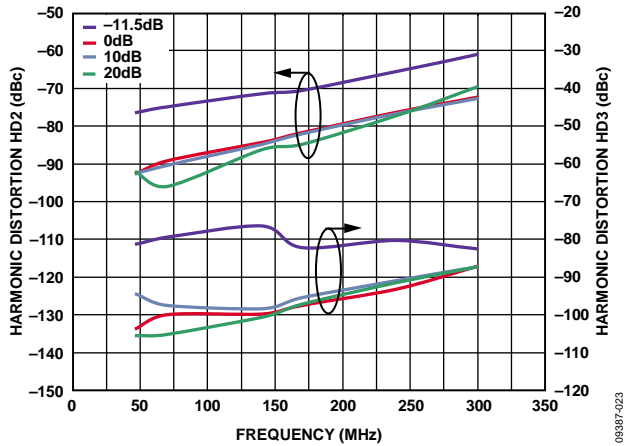

Figure 18. Harmonic Distortion vs. Frequency at Four Gain Codes

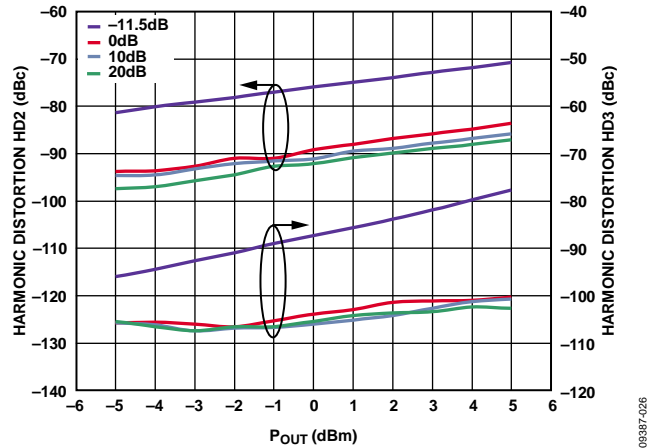

Figure 21. Harmonic Distortion vs. Power at Four Gains, Frequency = 140 MHz

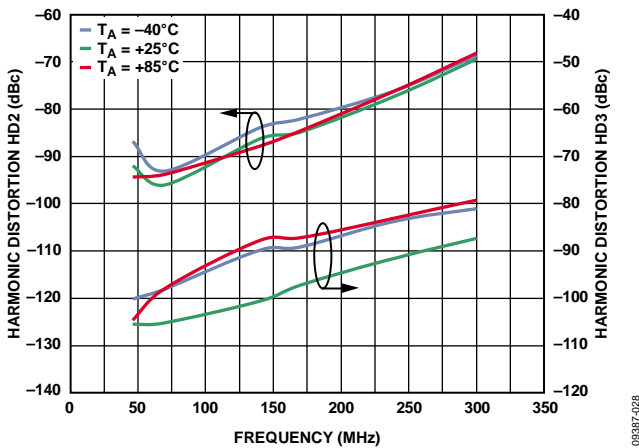

Figure 19. Harmonic Distortion vs. Frequency, Three Temperatures

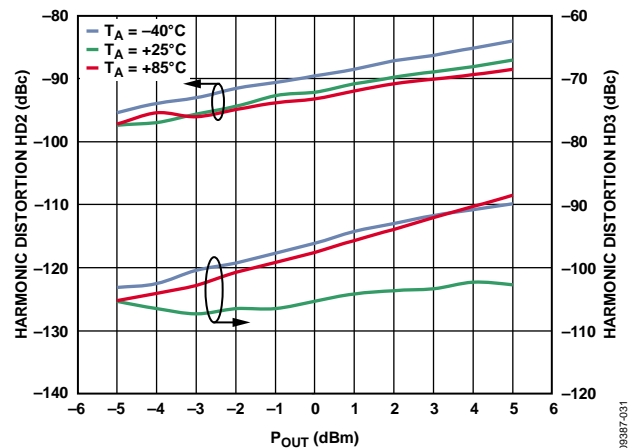

Figure 22. Harmonic Distortion vs. Power, Frequency = 140 MHz, Three Temperatures

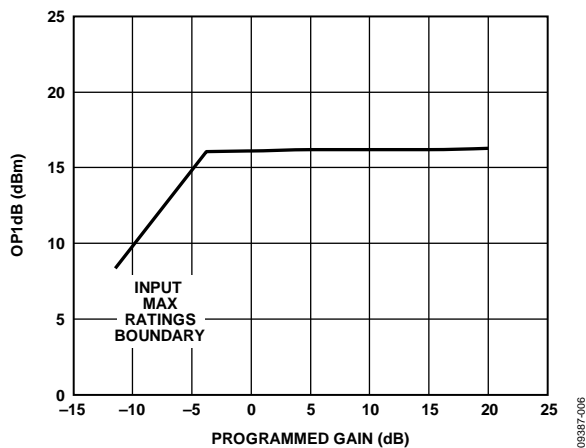

Figure 20. OP1dB vs. Programmed Gain at 140 MHz, Low Power Mode

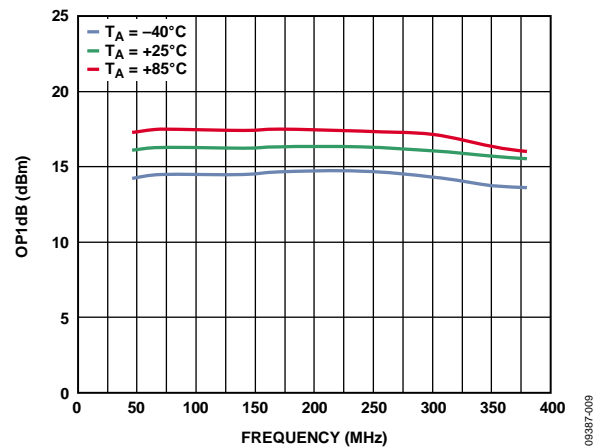

Figure 23. OP1dB vs. Frequency at Maximum Gain, Three Temperatures, Low Power Mode

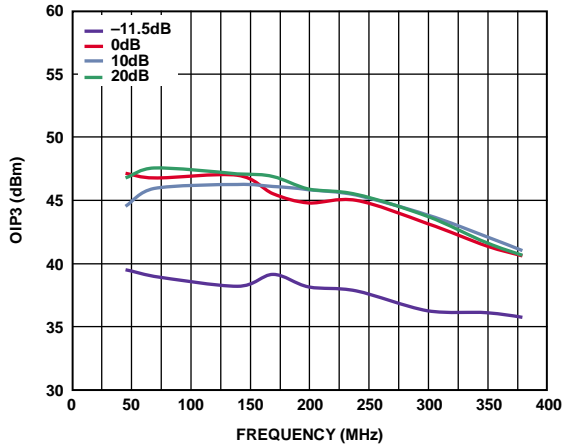

Figure 24. Output Third-Order Intercept vs. Frequency at Four Gain Codes, Low Power Mode at 2 V p-p Composite

09387-012

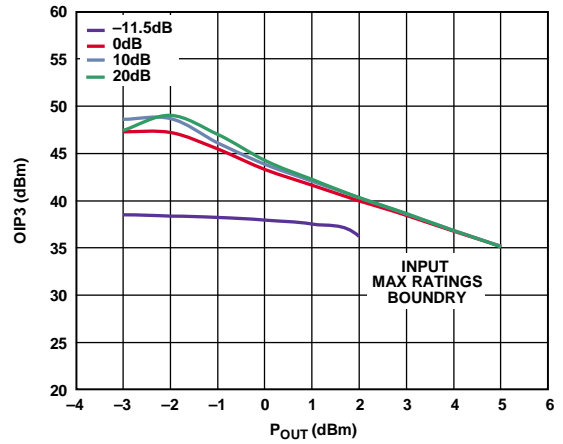

Figure 27. Output Third-Order Intercept vs. Power at Four Gain Codes, Frequency = 140 MHz, Low Power Mode

09387-015

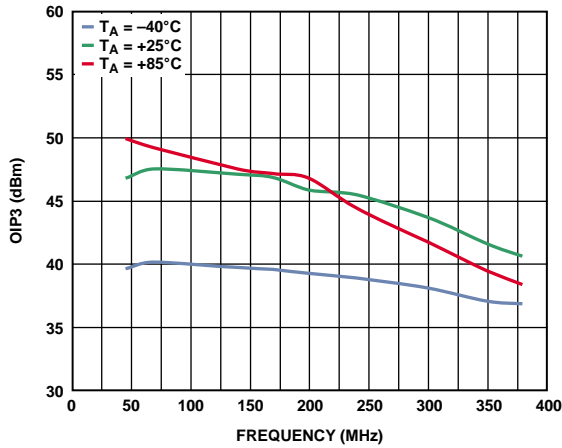

Figure 25. Output Third-Order Intercept vs. Frequency, Three Temperatures, Low Power Mode

09387-017

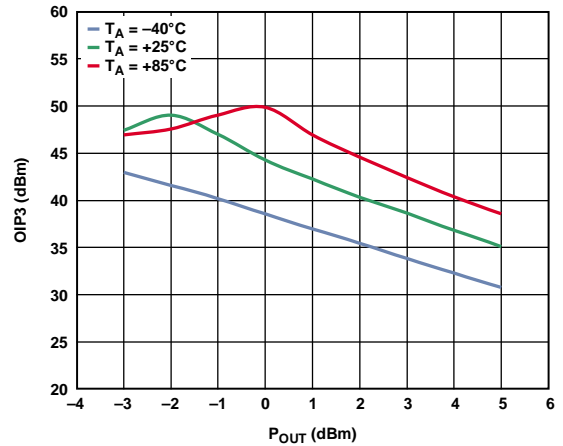

Figure 28. Output Third-Order Intercept vs. Power, Three Temperatures, Low Power Mode at 2 V p-p Composite

09387-020

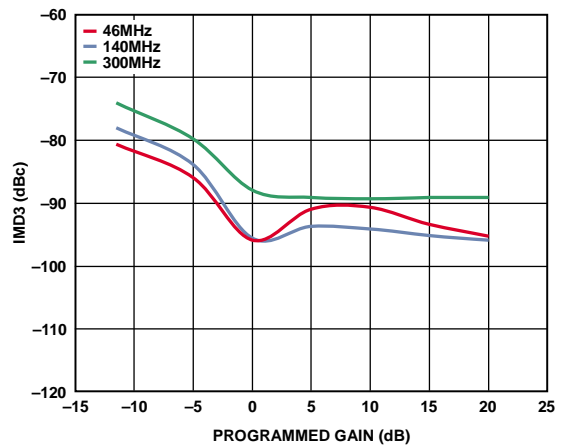

Figure 26. Two-Tone Output IMD3 vs. Programmed Gain at 46 MHz, 140 MHz, 300 MHz; Low Power Mode

09387-022

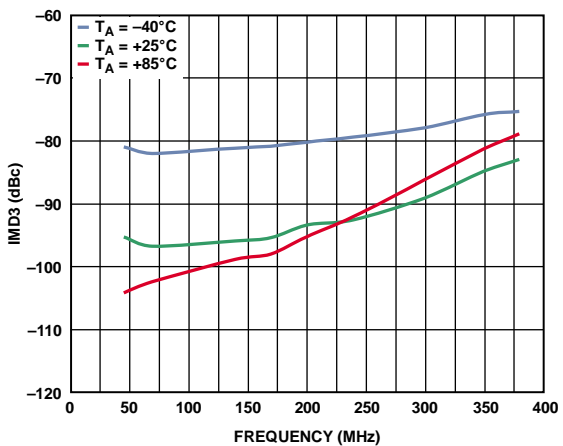

Figure 29. Two-Tone Output IMD3 vs. Frequency, Three Temperatures, Low Power Mode

09387-025

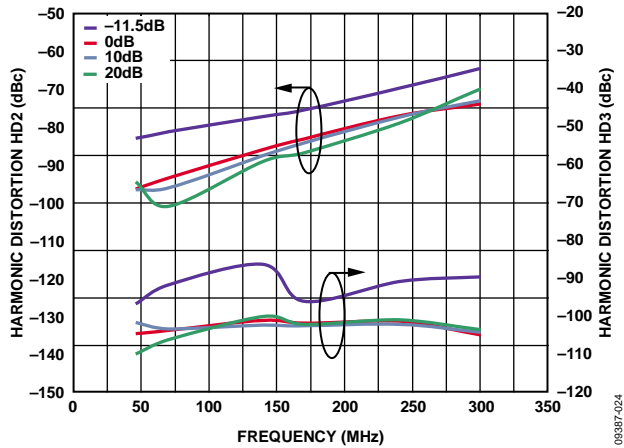

Figure 30. Harmonic Distortion vs. Frequency at Four Gain Codes, Low Power Mode

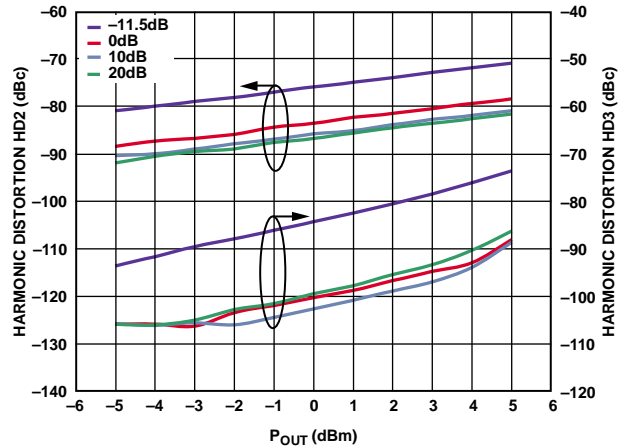

Figure 33. Harmonic Distortion vs. Power at Four Gain Codes, Frequency = 140 MHz, Low Power Mode

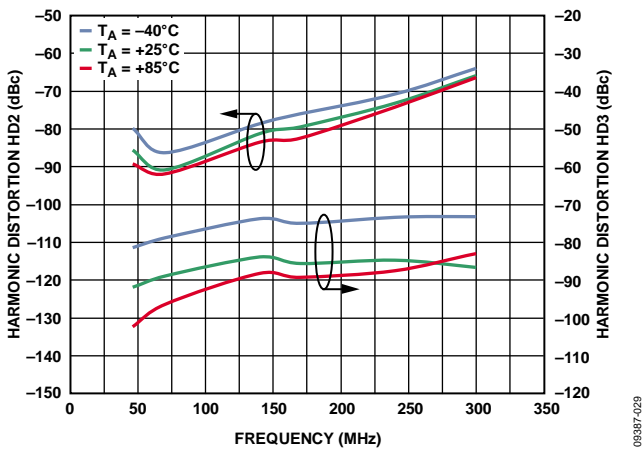

Figure 31. Harmonic Distortion vs. Frequency, Three Temperatures, Low Power Mode

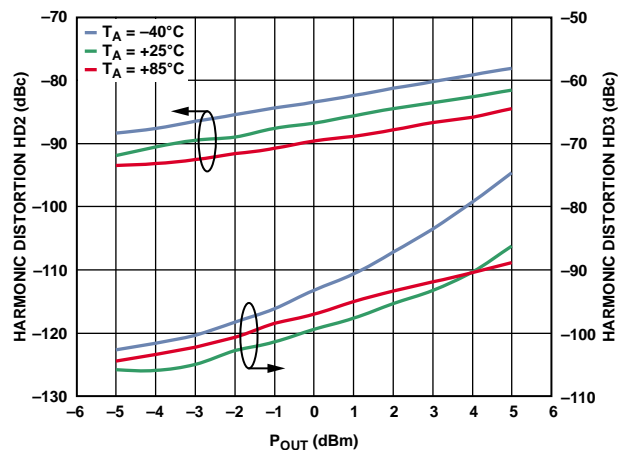

Figure 34. Harmonic Distortion vs. Power, Frequency = 140 MHz, Three Temperatures, Low Power Mode

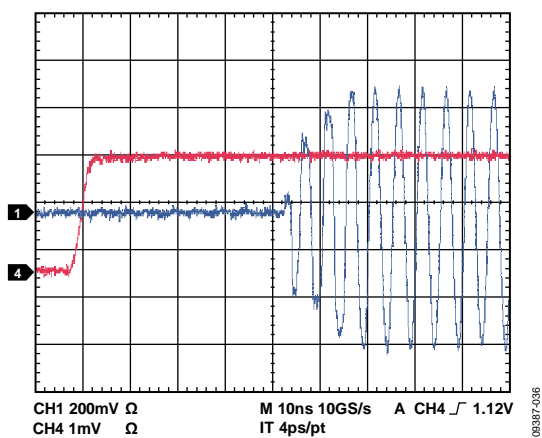

Figure 32. Enable Time Domain Response

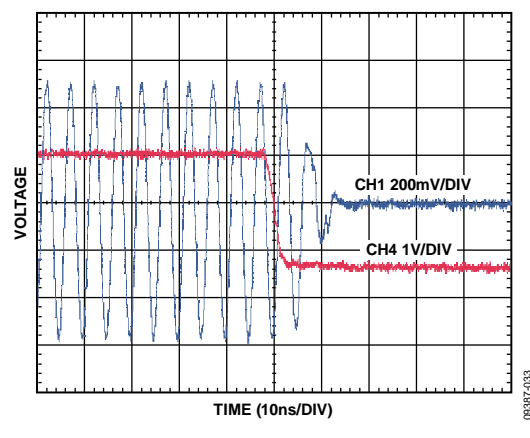

Figure 35. Disable Time Domain Response

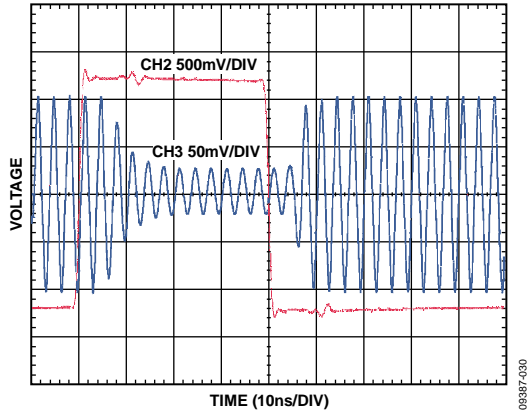

Figure 36. Gain Step Time Domain Response

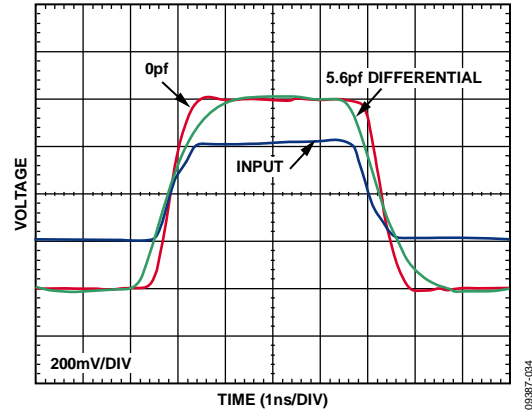

Figure 39. Large Signal Pulse Response, 0 pF and 5.6 pF, 2 V p-p Composite

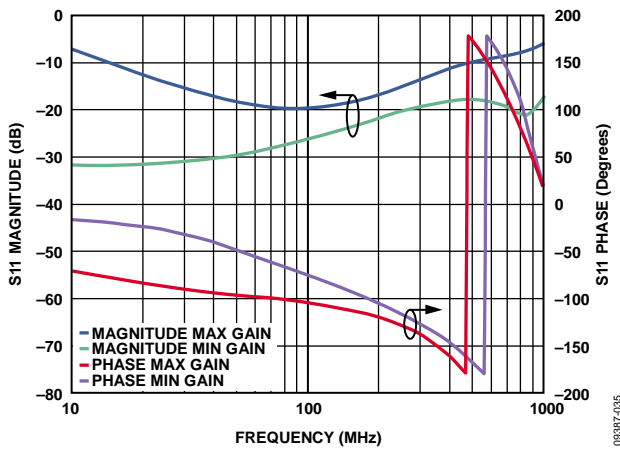

Figure 37. S11 Magnitude and Phase vs. Frequency

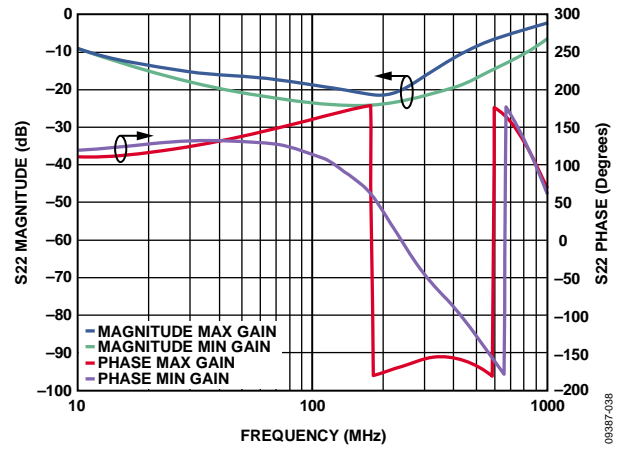

Figure 40. S22 Magnitude and Phase vs. Frequency

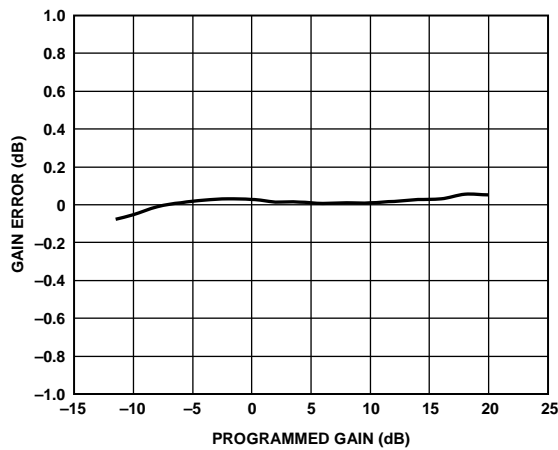

Figure 38. Gain Step Error, Frequency = 140 MHz

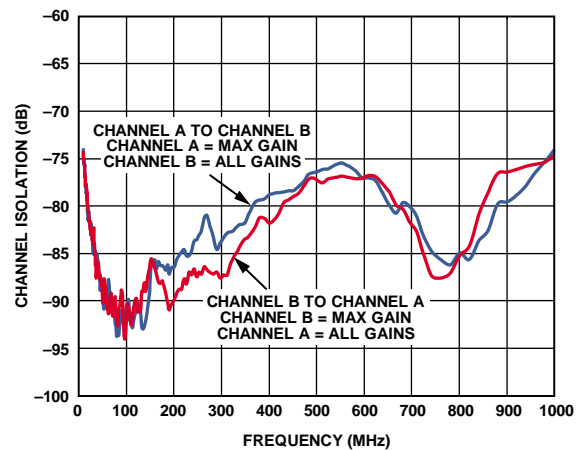

Figure 41. Channel Isolation vs. Frequency

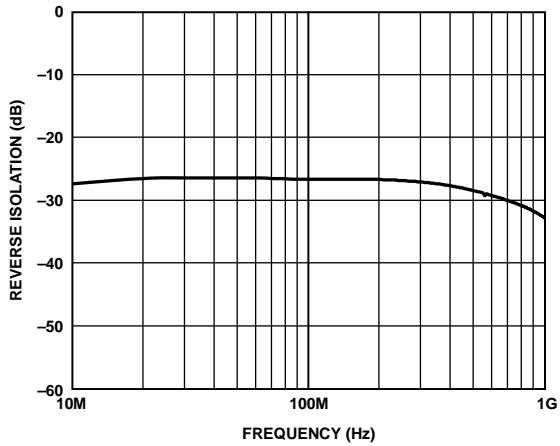

Figure 42. Reverse Isolation vs. Frequency

09387-039

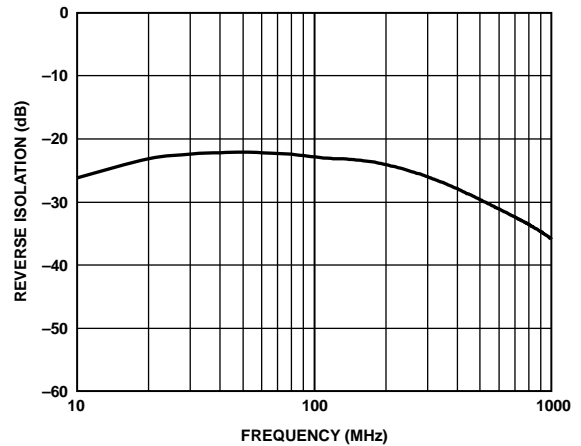

Figure 45. Disable-State Reverse Isolation vs. Frequency

09387-042

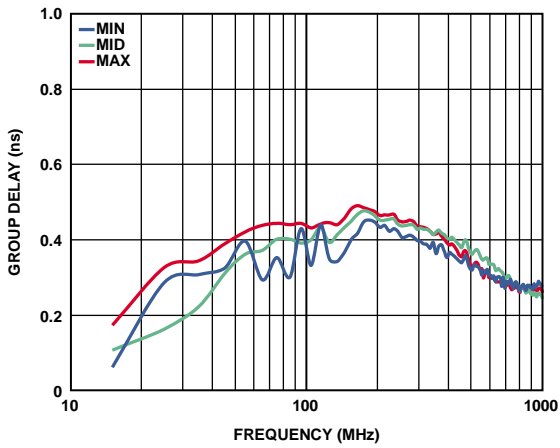

Figure 43. Group Delay vs. Frequency at Max, Mid, and Min Gain Outputs

09387-040

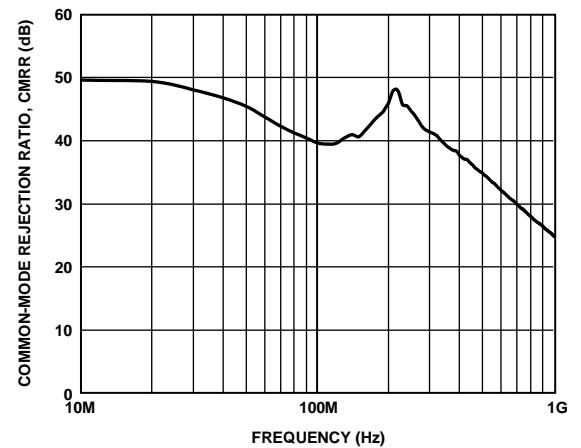

Figure 46. Common-Mode Rejection Ratio vs. Frequency

09387-044

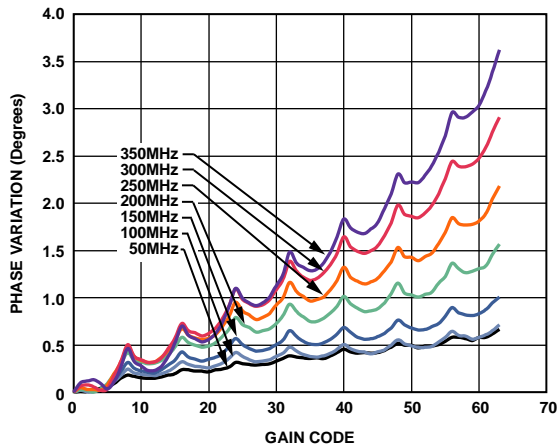

Figure 44. Phase Variation vs. Gain Code

09387-041

CHARACTERIZATION AND TEST CIRCUITS

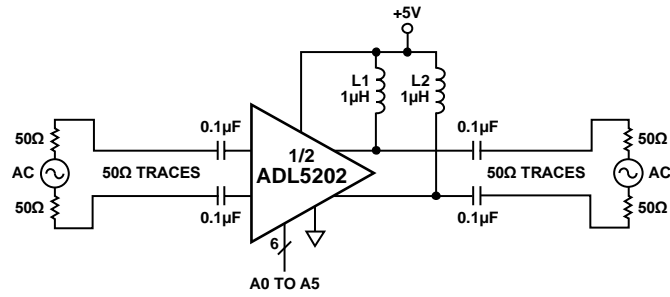

Figure 47. Test Circuit for S-Parameters on Dedicated 50 Ω Differential-to-Differential Board

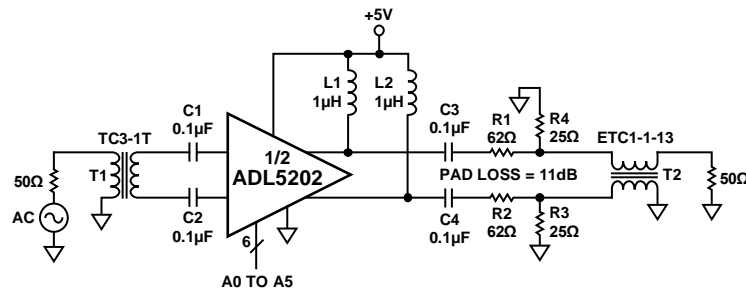

Figure 48. Test Circuit for Distortion, Gain, and Noise

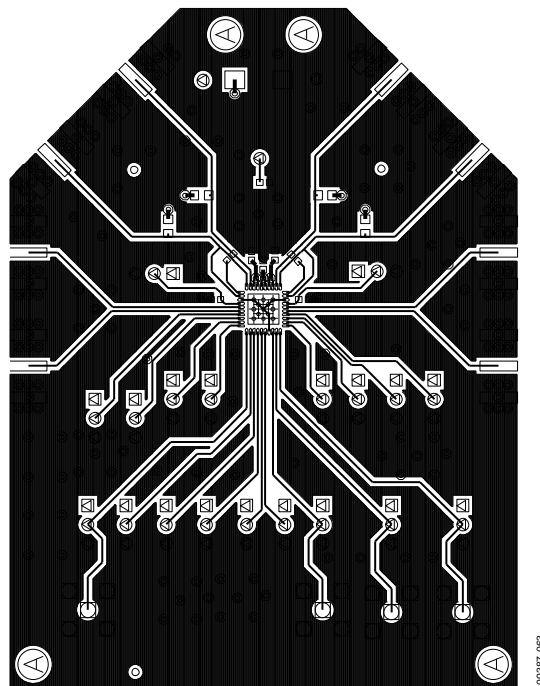

Figure 49. Differential-to-Differential Characterization Board, Circuit Side Layout

THEORY OF OPERATION

DIGITAL INTERFACE OVERVIEW

The ADL5202 VGA has three digital gain control options: the parallel control interface, serial peripheral interface, and gain up/down interface. The desired gain control option is selected via two control pins, MODE0 and MODE1 (see Table 4 for the truth table for the mode control pins). The gain code is in a 6-bit binary format. A voltage of between 1.4 V and 3.3 V is required for a logic high.

Three pins are common to all gain control options: PM, PWUPA, and PWUPB. PM allows the user to choose operation in nominal mode or high performance mode. PWUPA and PWUPB are power-up pins for Channel A and Channel B, respectively. Physical pins are shared among the three interfaces, resulting in as many as three different functions per digital pin (see Table 3).

Table 4. Digital Control Interface Selection Truth Table

MODE1	MODE0	Interface
0	0	Parallel control
0	1	Serial peripheral (SPI)
1	0	Up/down
1	1	Up/down

PARALLEL DIGITAL INTERFACE

The parallel digital interface uses six binary bits (Bits[A5:A0] or Bits[B5:B0]) and a latch pin (LATCHA or LATCHB) per amplifier. The latch pin controls whether the input data latch is transparent or latched. In transparent mode, gain changes as input gain control bits change. In latched mode, gain is determined by the latched gain setting and does not change with changing input gain control bits.

SERIAL PERIPHERAL INTERFACE (SPI)

The SPI uses three pins (SDIO, SCLK, and \overline{CSA} or \overline{CSB}). The SPI data register consists of two bytes: six gain control bits, two attenuation step size address bits, one read/write bit, and seven don't care bits. SDIO is the serial data input and output pin. The SCLK pin is the serial clock, and \overline{CSA} or \overline{CSB} is the channel select pin.

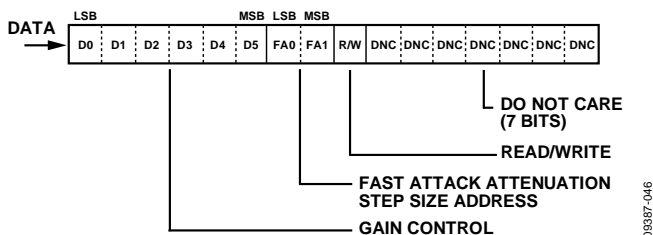

Figure 50. 16-Bit SPI Register

To write to the SPI register, \overline{CSA} or \overline{CSB} must be pulled low and 16 clock pulses must be applied to SCLK. Individual channel SPI registers can be selected by pulling \overline{CSA} or \overline{CSB} low. By pulling the \overline{CSA} and \overline{CSB} pins low simultaneously, the same data can be written to both SPI registers.

To read the SPI register value, the R/W bit must be set high, \overline{CSA} or \overline{CSB} must be pulled low, and the part must be clocked. After the register has been read out during the next 16 clock cycles, the SPI is automatically put into write mode. Note that there is only one SDIO pin. Readback from the registers should be performed individually.

Fast Attack

The fast attack feature, accessible via the SPI, allows the gain to be reduced from its present gain setting by a predetermined step size. Four different attenuation step sizes are available. The truth table for fast attack is shown in Table 5.

Table 5. SPI 2-Bit Attenuation Step Size Truth Table

FA1	FA0	Step Size (dB)
0	0	2
0	1	4
1	0	8
1	1	16

SPI fast attack mode is controlled by the FA_A or FA_B pin. A logic high on the FA_A or FA_B pin results in an attenuation that is selected by Bits[FA1:FA0] in the SPI register.

GAIN UP/DOWN INTERFACE

The GS1 and GS0 pins control the up/down gain step function. Gain is increased by a clock pulse on the UPDN_CLK_A pin or the UPDN_CLK_B pin (rising and falling edges) when the UPDN_DAT_A or UPDN_DAT_B pin is high. Gain is decreased by a clock pulse on the UPDN_CLK_A or UPDN_CLK_B pin when the UPDN_DAT_A or UPDN_CLKB pin is low. The truth table for the gain step function is shown in Table 6. Reset is detected by a rising edge latching data having one polarity, with the falling edge latching the opposite polarity. Reset results in a minimum binary gain code of 111111.

Table 6. Step Size Control Truth Table

GS1	GS0	Step Size (dB)
0	0	0.5
0	1	1
1	0	2
1	1	4

The step size is selectable using the GS1 and GS0 pins. The gain is limited by the top and bottom of the control range.

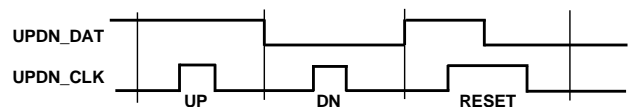

Figure 51. Up/Down Timing

TRUTH TABLE

Table 7. Gain Code vs. Voltage Gain Lookup Table

6-Bit Binary Gain Code	Voltage Gain (dB)	6-Bit Binary Gain Code	Voltage Gain (dB)
000000	20	100000	4
000001	19.5	100001	3.5
000010	19	100010	3
000011	18.5	100011	2.5
000100	18	100100	2
000101	17.5	100101	1.5
000110	17	100110	1
000111	16.5	100111	0.5
001000	16	101000	0
001001	15.5	101001	-0.5
001010	15	101010	-1
001011	14.5	101011	-1.5
001100	14	101100	-2
001101	13.5	101101	-2.5
001110	13	101110	-3
001111	12.5	101111	-3.5
010000	12	110000	-4
010001	11.5	110001	-4.5
010010	11	110010	-5
010011	10.5	110011	-5.5
010100	10	110100	-6
010101	9.5	110101	-6.5
010110	9	110110	-7
010111	8.5	110111	-7.5
011000	8	111000	-8
011001	7.5	111001	-8.5
011010	7	111010	-9
011011	6.5	111011	-9.5
011100	6	111100	-10
011101	5.5	111101	-10.5
011110	5	111110	-11
011111	4.5	111111	-11.5

LOGIC TIMING

To write to the [ADL5202](#), refer to the timing shown in Figure 2 (reproduced in this section as Figure 52). The write mode uses a 16-bit serial word on the SDIO pin. The R/W of the word must be low to write Bits[D0:D5], which are the binary weighted codes for the attenuation level (0 = minimum attenuation, 63 = maximum attenuation). The FA0 and FA1 bits control the fast attack step size. The DNC bits are nonfunctional, do not care bits. Reading the [ADL5202](#) SPI register requires the following two steps:

1. Set the R/W bit high using a 16-bit word and the timing described in this section and Figure 52. All other bits are ignored when the R/W bit is high.
2. The SDIO is used as an output during the next sequence. The written pattern is serially clocked out on SDIO using 16 clocks and the timing described in this section and Figure 52. The R/W bit automatically returns low to the write state following the read sequence.

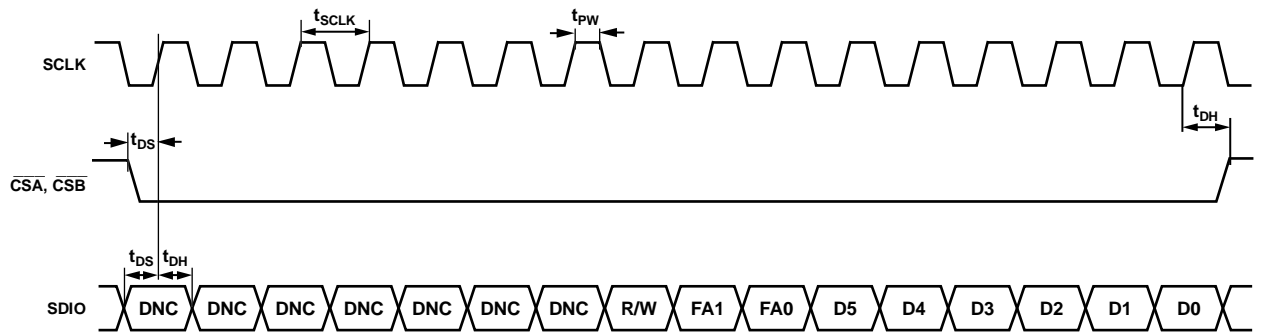

Figure 52. SPI Interface Read/Write Mode Timing Diagram

09387-152

CIRCUIT DESCRIPTION

BASIC STRUCTURE

The ADL5202 is a dual, differential, variable gain amplifier, with each amplifier consisting of a 150 Ω digitally controlled, passive attenuator that is followed by a highly linear transconductance amplifier with feedback.

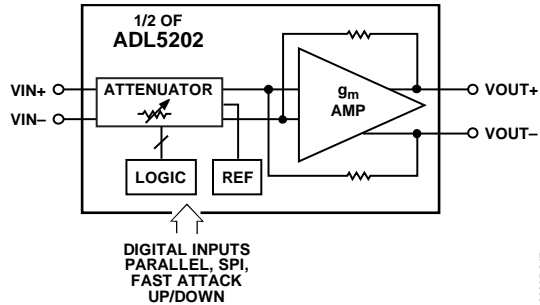

Figure 53. Simplified Schematic

Input System

The dc voltage level at the inputs of each amplifier is set by two independent internal voltage reference circuits to approximately 1.6 V. The references are not accessible and cannot be adjusted.

Each amplifier can be powered down by pulling the corresponding power-up pin down to ground (logic low). When powered down, the total current of each amplifier reduces to 7 mA (typical). The dc level at the inputs remains at approximately 1.6 V, regardless of the state of the PWUPA or PWUPB pin.

Output Amplifier

The gain of the output amplifier is set to 22 dB when driving a 150 Ω load. The input and output resistance of this amplifier is set to 150 Ω in matched condition. If the load or the source resistance is different from 150 Ω, the following equations can be used to determine the resulting gain and input/output resistances.

$$\text{Voltage Gain} = A_V = 0.09 \times (2000) // R_L$$

$$R_{IN} = (2000 + R_L) / (1 + 0.09 \times R_L)$$

$$S21 (\text{Gain}) = 2 \times R_{IN} / (R_{IN} + R_S) \times A_V$$

$$R_{OUT} = (2000 + R_S) / (1 + 0.09 \times R_S)$$

Note that at the maximum attenuation setting, R_S , as seen by the output amplifier, is the output resistance of the attenuator, which is 150 Ω. However, at minimum attenuation, R_S is the source resistance that is connected to the input of the part.

The dc current to the outputs of each amplifier is supplied through two external chokes. The inductance of the chokes and the resistance of the load, in parallel with the output resistance of the device, add a low frequency pole to the response. The parasitic capacitance of the chokes adds to the output capacitance of the part. This total capacitance, in parallel with the load and output resistance, sets the high frequency pole of the device. Generally, the larger the inductance of the choke, the higher its parasitic capacitance. Therefore, this trade-off must be considered when the value and type of the choke are selected. For an operation frequency of 15 MHz to 700 MHz driving a 150 Ω load, 1 μH chokes with a self resonant frequency (SRF) of 160 MHz or higher are recommended (such as the 0805LS-102XJBB from Coilcraft). If higher value chokes are used, a 4 MHz zero, due to the internal ac-coupled feedback, causes an increase in S21 of up to 6 dB at frequencies below 4 MHz. The supply current of each amplifier consists of about 35 mA through the VPOS pin and 50 mA through the two chokes combined. The latter increases with temperature at approximately 2.5 mA per 10°C. The total choke current increases to 75 mA for high performance mode. Each amplifier has two output pins for each polarity, and they are oriented in an alternating fashion. When designing the board, care should be taken to minimize the parasitic capacitance due to the routing that connects the corresponding outputs together. To minimize the parasitic capacitance, a good practice is to avoid any ground or power plane under this routing region and under the chokes.

Gain Control

The gain of each amplifier can be adjusted using the parallel control interface, the serial peripheral interface, or the gain up/down interface. In general, the gain step size is 0.5 dB, but larger sizes can be programmed using the various interfaces, as described in the Digital Interface Overview section. Each amplifier has a maximum gain of +20 dB (Code 0) to -11.5 dB (Code 63).

The noise figure of each amplifier is approximately 7.5 dB at maximum gain setting, and it increases as the gain is reduced. The increase in noise figure is equal to the reduction in gain. The linearity of the part measured at the output is first-order independent of the gain setting. From -4 dB to +20 dB gain, OIP3 is approximately 50 dBm into 150 Ω load at 200 MHz (0 dBm per tone). At gain settings below -4 dB, OIP3 drops to approximately 40 dBm.

APPLICATIONS INFORMATION

BASIC CONNECTIONS

Figure 54 shows the basic connections for operating the ADL5202. A voltage between 4.5 V and 5.5 V should be applied to the VPOS pins. Each supply pin should be decoupled with at least one low inductance, surface-mount ceramic capacitor of 0.1 μ F, placed as close as possible to the device.

The outputs of the ADL5202 must be pulled up to the positive supply with 1 μ H RF chokes. The differential outputs are biased to the positive supply and require ac coupling capacitors, preferably 0.1 μ F. Similarly, the input pins are at bias voltages of about 1.6 V above ground and should be ac-coupled as well. The ac coupling capacitors and the RF chokes are the principle limitations for operation at low frequencies.

The digital pins (mode control pins, associated SPI and parallel gain control pins, PM, PWUPA, and PWUPB) operate on a voltage of 3.3 V.

To enable each channel of the ADL5202, the PWUPA or PWUPB pin must be pulled high ($1.4 \text{ V} \leq \text{PWUPA/PWUPB} \leq 3.3 \text{ V}$). Taking PWUPA or PWUPB low puts the channels of the ADL5202 in sleep mode, reducing current consumption to approximately 7 mA per channel at ambient.

ADC DRIVING

The ADL5202 is a highly linear, variable gain amplifier that is optimized for ADC interfacing. The output IMDs and noise floor remain constant throughout the 31.5 dB gain range. This is a valuable feature in a variable gain receiver where it is desirable to maintain a constant instantaneous dynamic range as the receiver range is modified. The output noise is 18 nV/ $\sqrt{\text{Hz}}$, which is compatible with 14- or 16-bit ADCs. The two-tone IMDs are usually greater than -100 dB for -1 dBm into 150 Ω or 2 V p-p output. The 150 Ω output impedance makes the task of designing a filter for the high input impedance ADCs more straightforward.

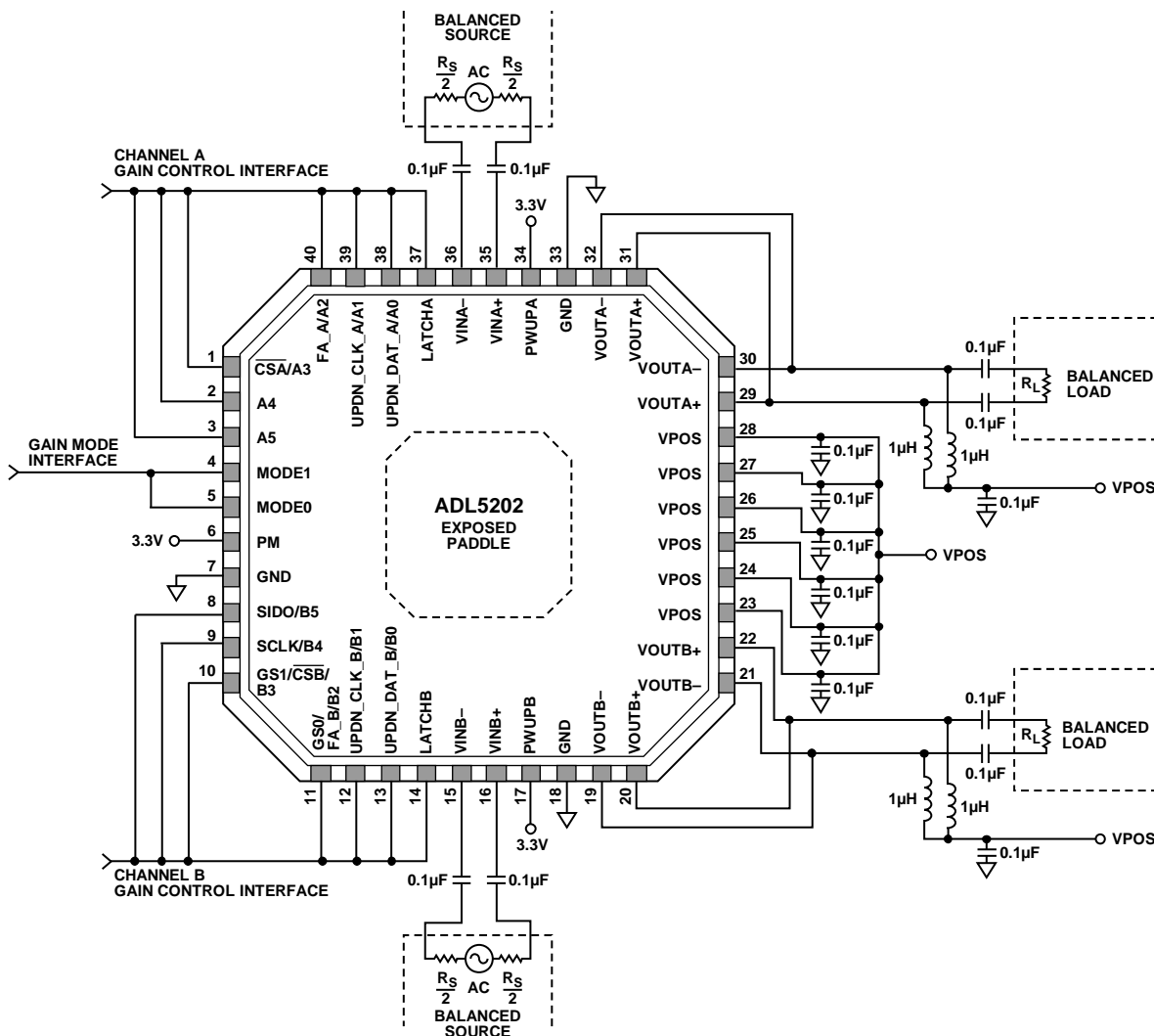

Figure 54. Basic Connections

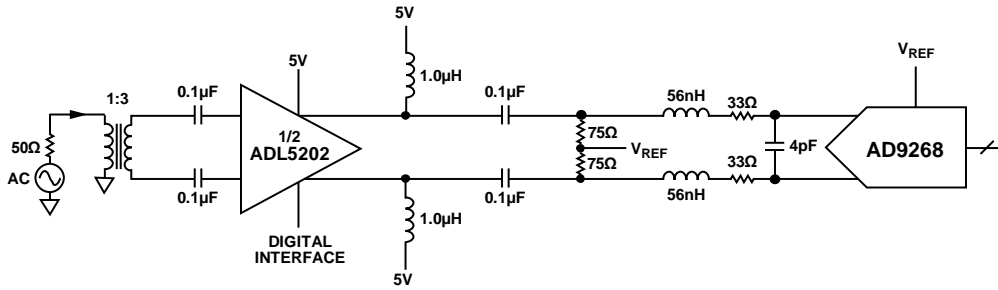

Figure 55. Wideband ADC Interfacing Example Featuring One-Half of the ADL5202 and the AD9268

Figure 55 shows one-half of the ADL5202 driving a two-pole, 100 MHz low-pass filter into the AD9268. The AD9268 is a 16-bit, 125 MSPS analog-to-digital converter with a buffered wideband input, which presents a 6 kΩ differential input impedance and requires between a 1 V or 2 V input swing to reach full scale. This example uses the 2 V p-p input. For optimum performance, the ADL5202 should be driven differentially, using an impedance transformer or input balun.

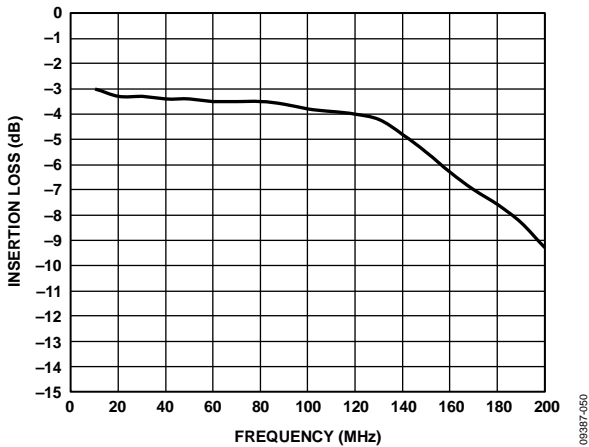

Figure 56. Measured Frequency Response of Wideband ADC Interface, as Depicted in Figure 55

Figure 55 uses a 1:3 impedance transformer to provide the 150 Ω input impedance of the ADL5202 with a matched input. The outputs of the ADL5202 are biased through the two 1 µH inductors, and the two 0.1 µF capacitors on the outputs decouple the 5 V inductor voltage from the input common-mode voltage of the AD9268. The two 75 Ω resistors provide the 150 Ω load to the ADL5202 whose gain is load dependent. The 56 nH inductors and 4 pF capacitor constitute the (100 MHz – 1 dB) low-pass filter. The two 33 Ω isolation resistors suppress any switching currents from the ADC input sample-and-hold circuitry. The circuit depicted in Figure 55 provides variable gain, isolation, filtering, and source matching for the AD9268. Using this circuit with the ADL5202 in a gain of 20 dB (maximum gain), an SNR of 69 dB, and an SFDR performance of >86 dBc is achieved at 100 MHz, as shown in Figure 57.

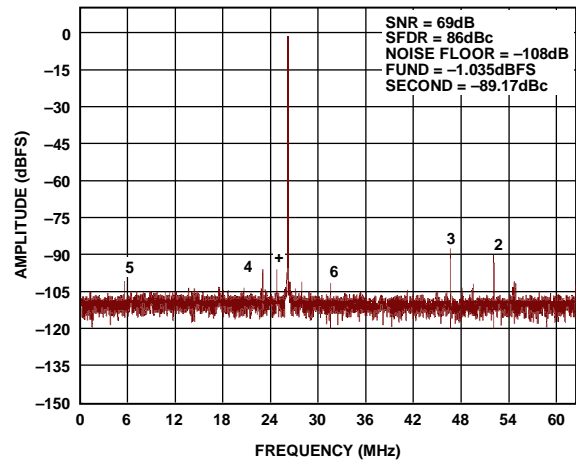

Figure 57. Measured Single-Tone Performance of the Circuit in Figure 55 for a 100 MHz Input Signal

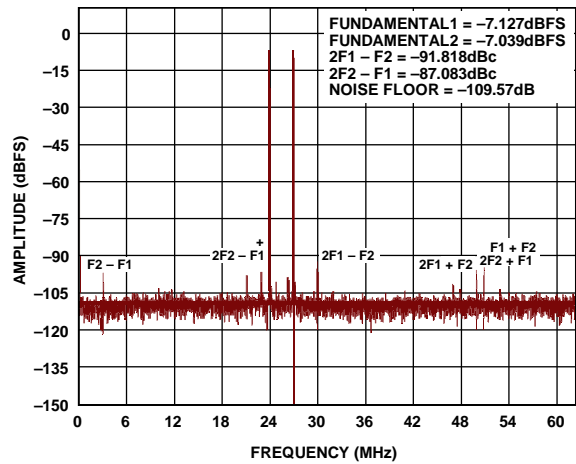

Figure 58. Measured Two-Tone Performance of the Circuit in Figure 55 for a 100 MHz Input Signal

An alternative narrow-band approach is presented in Figure 59. By designing a narrow band-pass antialiasing filter between the ADL5202 and the target ADC, the output noise of the ADL5202 outside of the intended Nyquist zone can be attenuated, helping to preserve the available SNR of the ADC. In general, the SNR improves by several decibels (dB) when including a reasonable order antialiasing filter. In this example, a low loss 1:3 input transformer is used to match the 150 Ω balanced input of the ADL5202 to a 50 Ω unbalanced source, resulting in minimum insertion loss at the input.

Figure 59 is optimized for driving some of the Analog Devices popular unbuffered ADCs, such as the AD9246, AD9640, and AD6655. Table 8 includes antialiasing filter component recommendations for popular IF sampling center frequencies. Inductor L5 works in parallel with the on-chip ADC input capacitance and a portion of the capacitance presented by C4 to form a resonant tank circuit. The resonant tank helps to ensure that the ADC input acts like a real resistance at the target center frequency.

In addition, the L6 inductor shorts the ADC inputs at dc, which introduces a zero into the transfer function. The ac coupling capacitors and the bias chokes introduce additional zeros into the

transfer function. The final overall frequency response takes on a band-pass characteristic, helping to reject noise outside of the intended Nyquist zone. Table 8 provides initial suggestions for prototyping purposes. Some empirical optimization may be needed to help compensate for actual PCB parasitics.

LAYOUT CONSIDERATIONS

The ADL5202 has two output pins for each polarity, and they are oriented in an alternating fashion. When designing the board, care should be taken to minimize the parasitic capacitance due to the routing that connects the corresponding outputs together. A good practice is to avoid any ground or power plane under this routing region and under the chokes to minimize the parasitic capacitance.

If the common-mode load capacitance including the capacitance of the trace is > 2 pF, use parasitic suppressing resistors at the device output pins. The resistors should be placed in the output traces just after the crossover connections. Use 5 Ω series resistors (Size 0402) to adequately de-Q the output system without a significant decrease in gain.

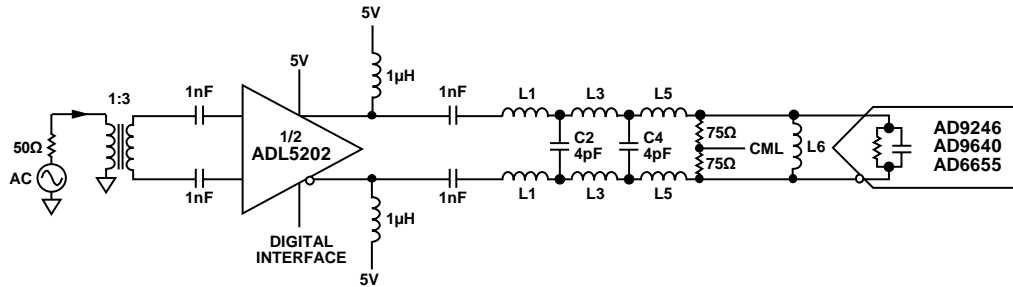

Figure 59. Narrow-Band IF Sampling Solution for Unbuffered ADC Applications

09387-063

Table 8. Interface Filter Recommendations for Various IF Sampling Frequencies

Center Frequency	1 dB Bandwidth	L1	C2	L3	C4	L5	L6
96 MHz	27 MHz	68 nH	15 pF	220 nH	15 pF	68 nH	150 nH
140 MHz	31 MHz	47 nH	11 pF	150 nH	11 pF	47 nH	82 nH
170 MHz	25 MHz	39 nH	10 pF	120 nH	10 pF	47 nH	51 nH
211 MHz	40 MHz	30 nH	7 pF	100 nH	7.5 pF	30 nH	43 nH

EVALUATION BOARD

The ADL5202 evaluation board is available with software to program the variable gain control. It is a 4-layer board with a split ground plane for analog and digital sections. Special care is taken to place the power decoupling capacitors close to the device pins. The board is designed for easy single-ended (through a Mini-Circuits TC3-1T+ RF transformer) or differential configuration for each channel.

EVALUATION BOARD CONTROL SOFTWARE

The ADL5202 evaluation board is configured with a USB-friendly interface to program the gain of the ADL5202. The software graphic user interface (see Figure 60) lets users select a particular gain mode and gain level to write to the device and also to read back data from the SDIO pin, showing the currently programmed gain setting. The software setup files can be downloaded from the ADL5202 product page at www.analog.com.

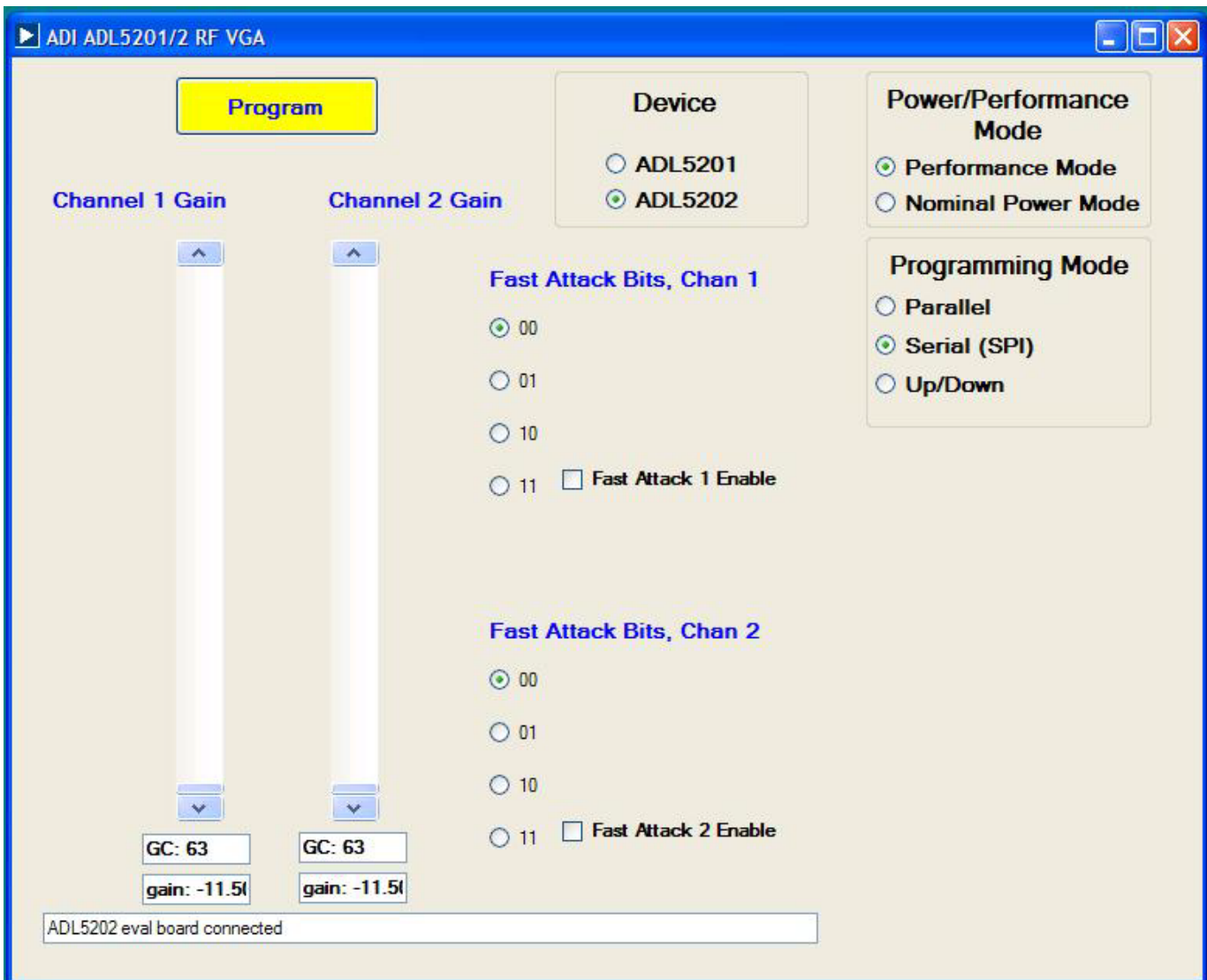

Figure 60. Evaluation Control Software

950-28660

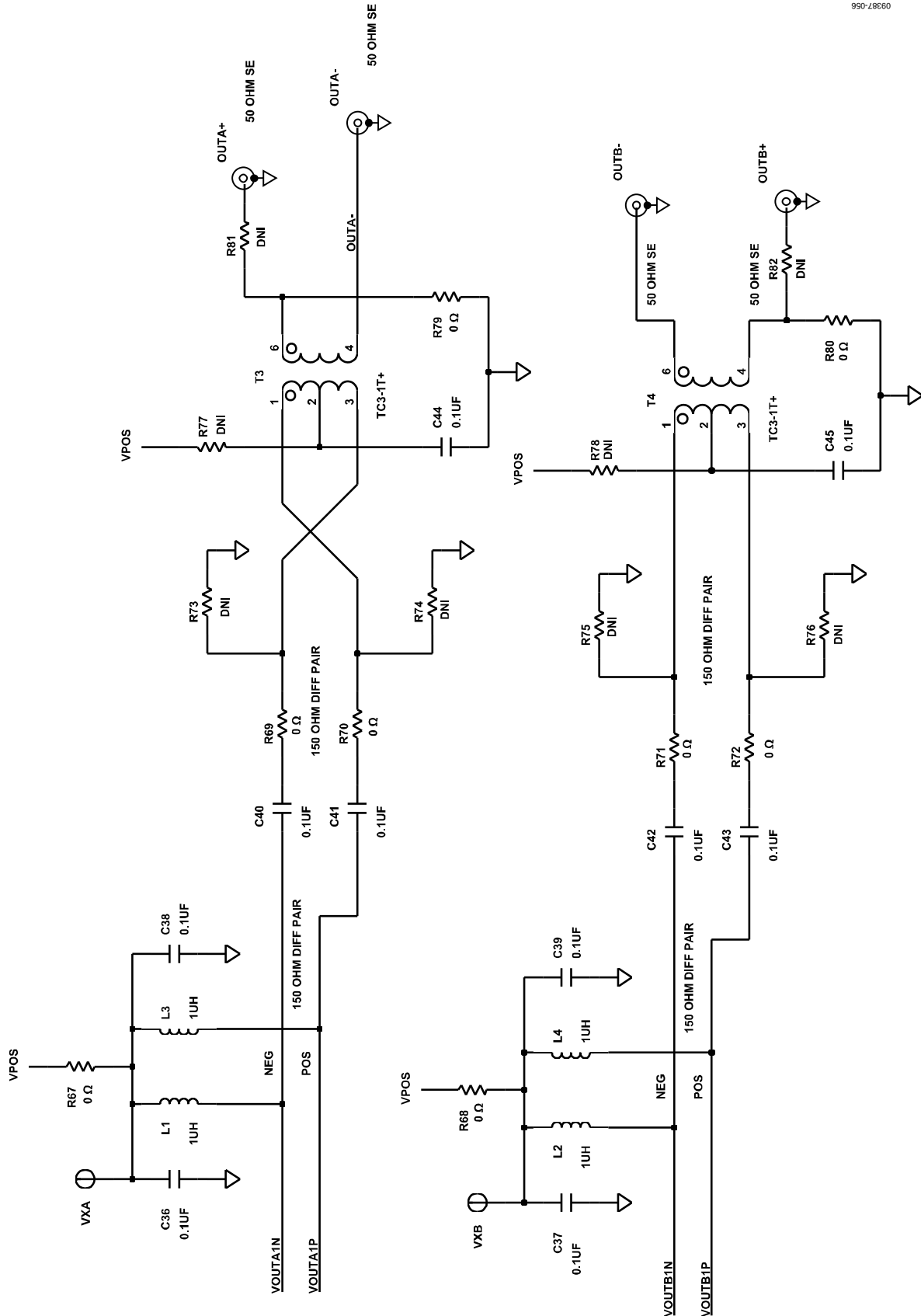
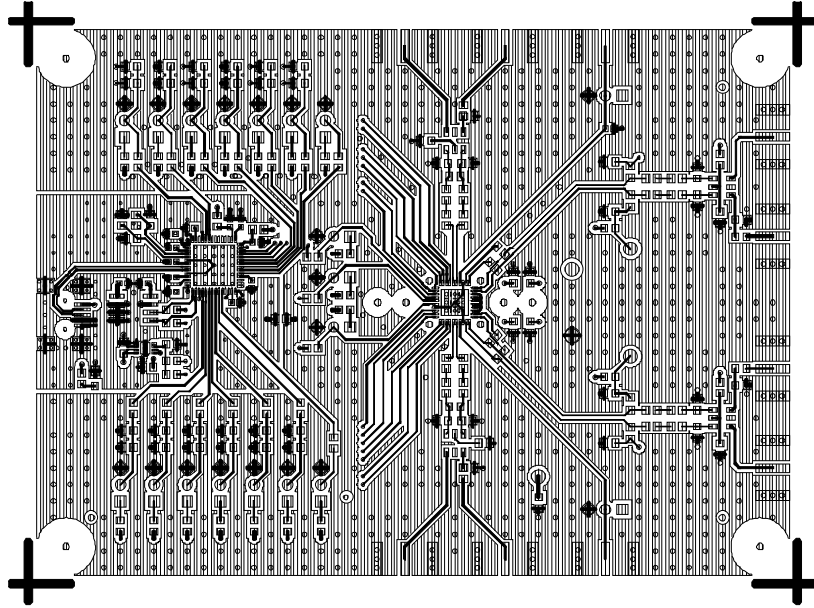
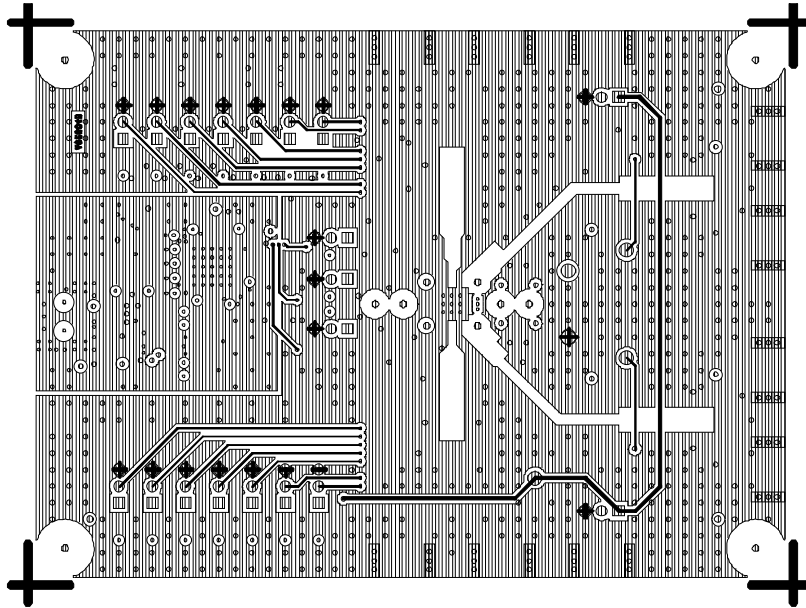

Figure 62. RF Output Detail



09387-058

Figure 64. Evaluation Board Top Layer



09387-059

Figure 65. Evaluation Board Bottom Layer

EVALUATION BOARD CONFIGURATION OPTIONS**Configuration Options for the Main Section****Table 9. Bill of Materials for Main Section**

Components	Function	Default Conditions
C24 to C27, C51	Power supply decoupling. Nominal supply decoupling consists of a 0.1 μF capacitor to ground.	C24 to C27, C51 = 0.1 μF (Size 0603)
VPOS, 3V3 GND	Power supply connections.	VPOS, 3V3 (test loop red) installed GND (test loop black) installed
DUT1	Evaluation device.	Installed
INA+, INA– INB+, INB– T1, T2, C18 to C23, R8, R9, R20 to R29, R88, R89	Input interfaces. The INA+ and INA– input SMA connectors are used to drive the Channel A balun in a single-ended fashion. The INB+ and INB– input SMAs are used to drive the Channel B balun in a single-ended fashion. The default configuration of the evaluation board is for single-ended operation. T1 and T2 are 3:1 impedance ratio RF transformers that are used to transform a 50 Ω , single-ended input into a 150 Ω balanced differential signal. C18 and C19 are balun decoupling capacitors. C20 to C23 are used for dc blocking purposes. R20 to R29 are provided for generic placement of matching components. R88 and R89 are populated to ground on one side of the transformer primary, creating the 50 Ω single-ended input.	INA+ (SMA connector) installed INA– (SMA connector) installed INB+ (SMA connector) installed INB– (SMA connector) installed T1, T2 = TC3-1T+ (Mini-Circuits) C18 to C23 = 0.1 μF (Size 0603) R8, R9, R26 to R29 = 0 Ω (Size 0402) R20 to R25, R88, R89 = open
OUTA+, OUTA– OUTB+, INB– T3, T4, C36 to C45, R63 to R82, L1 to L4 VXA, VXB	Output interfaces. The OUTA+ and OUTA– output SMA connectors are used to load the Channel A balun in a single-ended fashion. The default configuration of the evaluation board is for single-ended operation. The OUTB+ and OUTB– output SMAs are used to load the Channel B balun in a single-ended fashion. The default configuration of the evaluation board is for single-ended operation. T3 and T4 are 3:1 impedance ratio transformers used to transform a 50 Ω , single-ended output into a 150 Ω balanced differential load. C40 to C43 are used for ac coupling. C44 and C45 are balun decoupling capacitors. R69 to R76 are provided for generic placement of matching components. By removing R79 and R80 and installing 0 Ω at R81 and R82, the output is converted to a differential output. L1 to L4 provide dc bias to the output stages. R67 and R68 provide a connection to the 5 V power plane. Optionally, R67 and R68 can be removed and the output stage biased through the VXA and VXB terminals.	OUTA+ (SMA connector) installed OUTA– (SMA connector) installed OUTB+ (SMA connector) installed OUTB– (SMA connector) installed T3, T4 = TC3-1T+ (mini-circuits) C36 to C45 = 0.1 μF (Size 0603) R63 to R72, R77 to R80 = 0 Ω (Size 0402) R73 to R76, R81, R82 = open L1, L2, L3, L4 = 1 μH (Size 0805) VXA, VXB (test loop) installed
P1, P2, PWUPA, PWUPB, R30	Power-up interface. The ADL5202 is powered up by applying a logic high ($1.4\text{ V} \leq \text{PWUPA/PWUPB} \leq 3.3\text{ V}$) to PWUPA and PWUPB from an external source or by installing a shunt between Pin1 and Pin 2 of P1 and P2.	P1 installed for enable P2 installed for enable PWUPA (SMA connector) installed PWUPB (SMA connector) installed R30 = open
A0 to A5, B0 to B5, LATCHA, LATCHB, PM, MODE0, MODE1 R10 to R19, R31 to R62, R84 to R87, C28 to C35, C47 to C50	Gain control interface. All of the gain control functions are fully controlled via the USB microcontroller by using the supplied software. Three-pin headers allow for manual operation of the gain control, if desired. The R31 to R34, R45, R46, R53, R54, and R84 to R87 resistors and the C28 to C35 and C47 to C50 capacitors allow for the generic placement of filter components. The R10 to R19, R31 to R62, and R84 to R87 resistors isolate the gain control pins from the microcontroller and provide current limiting.	A0 to A5 (3-pin header) installed B0 to B5 (3-pin header) installed LATCHA (3-pin header) installed LATCHB (3-pin header) installed MODE0 (3-pin header) installed MODE1 (3-pin header) installed PM (3-pin header) installed R10 to R19 = 1 k Ω (Size 0603) R35 to R44 = 1 k Ω (Size 0603) R47 to R52 1 k Ω (Size 0603) R55 to R62 1 k Ω (Size 0603) R31 to R34 = open R45, R46 = open R53, R54 = open R84 to R87 = open C28 to C35 = open C47 to C50 = open

Configuration Options for the USB Section**Table 10. Bill of Materials for USB Section**

Components	Default Conditions
C7, C8	22 pF (Size 0603)
C13	1000 pF (Size 0603)
C2, C3, C4, C6, C10, C11, C12, C14, C16, C46	0.1 μ F (Size 0402)
C9, C15	1 μ F (Size 0402)
C1, C5	10 pF (Size 0402)
CR1	Green LED (Panasonic LNJ308G8TRA)
P3	USB SMT connector (Hirose Electric UX60A-MB-5ST 240-0003-4)
R1, R2, R5	2 k Ω (Size 0603)
R6,	78.7 k Ω (Size 0603)
R7	140 k Ω (Size 0603)
R3, R4	100 k Ω (Size 0603)
R83	0 Ω (Size 0603)
U2	USB microcontroller (Cypress CY7C68013A-56LFXC)
U1	64 kB EEPROM (Microchip 24LC64-I/SN)
U3	Low dropout regulator (Analog Devices ADP3334ACPZ)
Y1	24 MHz crystal oscillator (AEL Crystals X24M000000S244)

OUTLINE DIMENSIONS

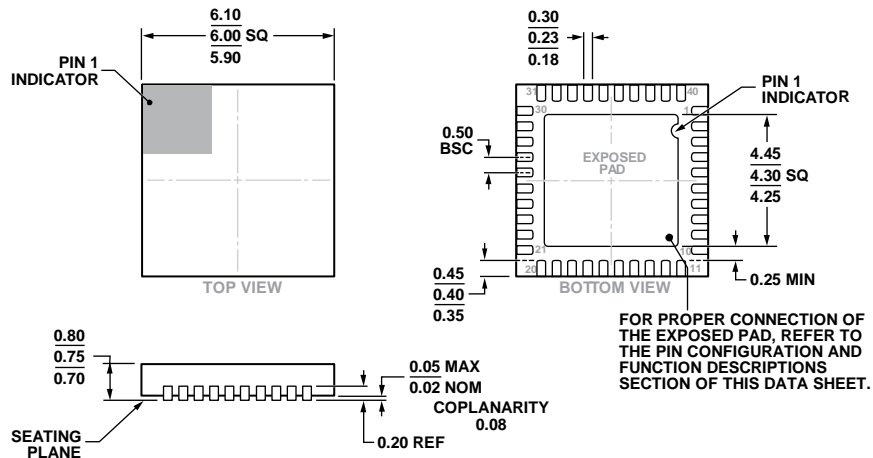

COMPLIANT TO JEDEC STANDARDS MO-220-WJJD.

Figure 66. 40-Lead Lead Frame Chip Scale Package [LFCSP_WQ]
 6 mm × 6 mm Body, Very Very Thin Quad
 (CP-40-10)
 Dimensions shown in millimeters

ORDERING GUIDE

Model ¹	Temperature Range	Package Description	Package Option
ADL5202ACPZ-R7	-40°C to +85°C	40 Lead LFCSP_WQ, 7" Tape and Reel	CP-40-10
ADL5202-EVALZ		Evaluation Board	

¹ Z = RoHS Compliant Part.

NOTES

NOTES

NOTES