

Coaxial Diplexer

ZDPL-6588-75-F+

75Ω 5 to 1700 MHz
(5 - 65, 88-1700 MHz)

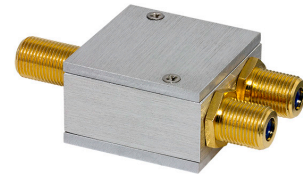

CASE STYLE: F2239

The Big Deal

- Low insertion loss, 1.2 dB typical
- High rejection
- High crossover isolation
- Excellent return loss
- 75Ω Impedance
- Used in DOCSIS 3.1 standard test systems with extended range

Product Overview

ZDPL-6588-75-F+ is a high performance diplexer with the lowpass port at 5-65 MHz and highpass port at 88-1700 MHz. Excellent return loss over extended frequency combined with high out of channel rejection makes it a ideal component in DOCSIS 3.1 test equipments, cable TV and multiband radio systems.

Key Features

Feature	Advantages
Low passband insertion loss	Passband insertion loss 1.2 dB typical ensures low signal loss through the both channels.
Excellent stopband rejection	Co-channel rejection of 50 dB typical ensures unwanted spurious are eliminated
Excellent return loss at 5-65 and 88-1700 MHz	This makes signal transmission with less reflections and well- matched with the adjacent component used in the system.

Notes

- A. Performance and quality attributes and conditions not expressly stated in this specification document are intended to be excluded and do not form a part of this specification document.
B. Electrical specifications and performance data contained in this specification document are based on Mini-Circuit's applicable established test performance criteria and measurement instructions.
C. The parts covered by this specification document are subject to Mini-Circuits standard limited warranty and terms and conditions (collectively, "Standard Terms"); Purchasers of this part are entitled to the rights and benefits contained therein. For a full statement of the Standard Terms and the exclusive rights and remedies thereunder, please visit Mini-Circuits' website at www.minicircuits.com/MCLStore/terms.jsp



Coaxial Diplexer

ZDPL-6588-75-F+

75Ω 5 to 1700 MHz (5-65, 88-1700 MHz)

Maximum Ratings

Operating Temperature	-40°C to 85°C
Storage Temperature	-55°C to 100°C
RF Power Input	30 dBm Max.

Permanent damage may occur if any of these limits are exceeded.

Coaxial Connections

HIGH PASS PORT	3
LOW PASS PORT	2
COMMON PORT	1

Features

- Low insertion loss
- Excellent return loss
- High rejection
- High cross over isolation
- 75Ω impedance

Applications

- Cable TV and Multiband radio systems
- DOCSIS 3.1 test system with extended range

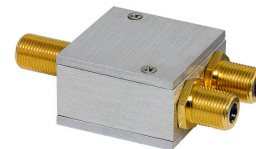

CASE STYLE: F2239

Connectors Model
F-Female ZDPL-6588-75-F+
BRACKET (OPTION "B")

+RoHS Compliant

The +Suffix identifies RoHS Compliance. See our web site for RoHS Compliance methodologies and qualifications

Outline Drawing

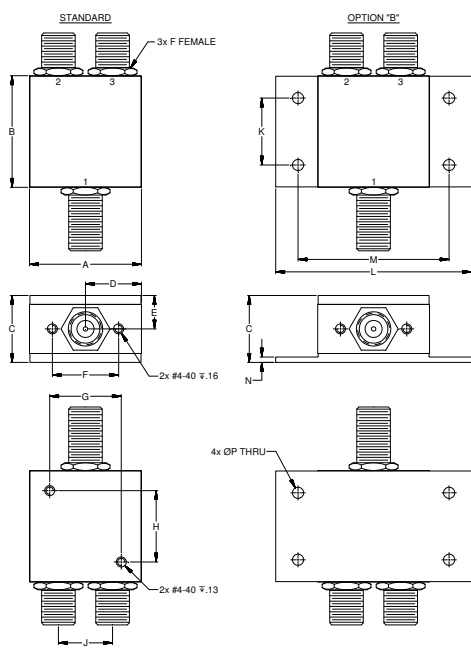

Outline Dimensions (inch/mm)

A	B	C	D	E	F	G	H
1.25	1.25	.75	.63	.38	.74	.80	.80
31.75	31.75	19.05	15.88	9.53	18.80	20.32	20.32
J	K	L	M	N	P	Wt.	
.61	.75	2.19	1.69	.06	.125	grams	
15.37	19.05	55.58	42.88	1.52	3.18	85	

Electrical Specifications at 25°C

Parameter	Port	Frequency (MHz)	Min.	Typ.	Max.	Unit	
Pass Band	Insertion Loss	Low Pass	5-65	-	1.0	1.5	dB
		High Pass	88-1220	-	1.2	1.5	
			1220-1400	-	1.0	1.5	
	Return Loss	Low Pass	5-65	20	24	-	dB
		High Pass	88-1220	17	20	-	
			1220-1400	17	20	-	
Common		5-65	20	24	-		
Stop Band	Isolation	Low Pass	88-1220	45	50	-	dB
		High Pass	1220-1700	50	60	-	
		Common	5-65	45	50	-	
Cross Over Isolation	LP-HP	65-88	32	35	-	dB	

Typical Performance Data at 25°C

FREQUENCY (MHz)	INSERTION LOSS (dB)		ISOLATION (dB)		RETURN LOSS (dB)	
	Low Pass Port	High Pass Port	LP-HP Port	Common Port	Low Pass Port	High Pass Port
1	0.01	83.62	94.01	49.09	48.16	0.01
5	0.05	82.40	79.67	44.23	41.53	0.02
50	0.34	52.96	52.60	30.83	29.57	0.16
65	0.99	52.36	54.43	33.88	32.31	0.47
70	3.48	38.25	42.75	8.09	8.10	0.73
71	5.73	32.62	40.99	5.00	4.76	0.82
73	13.08	23.11	40.56	2.47	1.89	1.08
74	17.59	19.12	41.28	2.18	1.39	1.29
75	22.46	15.43	42.33	2.22	1.13	1.62
76	27.79	11.99	43.75	2.58	0.97	2.16
77	33.82	8.91	45.97	3.35	0.86	3.06
78	40.84	6.35	49.10	4.75	0.79	4.55
79	48.60	4.45	53.82	6.95	0.74	6.80
80	53.28	3.20	59.99	10.01	0.69	9.87
85	55.63	1.44	54.49	39.65	0.57	31.50
88	54.94	1.19	54.00	36.40	0.53	33.70
250	66.12	0.41	65.65	26.75	0.32	35.19
500	68.32	0.46	67.78	28.01	0.27	26.26
1000	69.92	0.64	66.14	25.30	0.42	21.19
1220	68.18	0.74	65.69	26.36	0.55	22.53
1400	68.20	0.83	63.34	25.14	0.69	25.74
1700	58.58	1.11	57.80	21.79	1.10	35.11

Functional Schematic

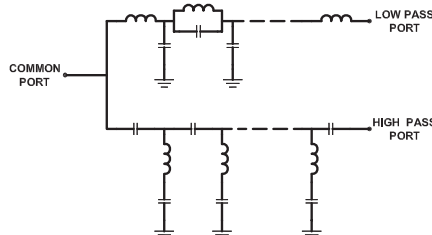

Notes

- Performance and quality attributes and conditions not expressly stated in this specification document are intended to be excluded and do not form a part of this specification document.
- Electrical specifications and performance data contained in this specification document are based on Mini-Circuits' applicable established test performance criteria and measurement instructions.
- The parts covered by this specification document are subject to Mini-Circuits standard limited warranty and terms and conditions (collectively, "Standard Terms"); Purchasers of this part are entitled to the rights and benefits contained therein. For a full statement of the Standard Terms and the exclusive rights and remedies thereunder, please visit Mini-Circuits' website at www.minicircuits.com/MCLStore/terms.jsp



www.minicircuits.com P.O. Box 350166, Brooklyn, NY 11235-0003 (718) 934-4500 sales@minicircuits.com

REV. OR
M163648
ZDPL-6588-75-F+
EDU2737/1
URJ
180125
Page 2 of 3

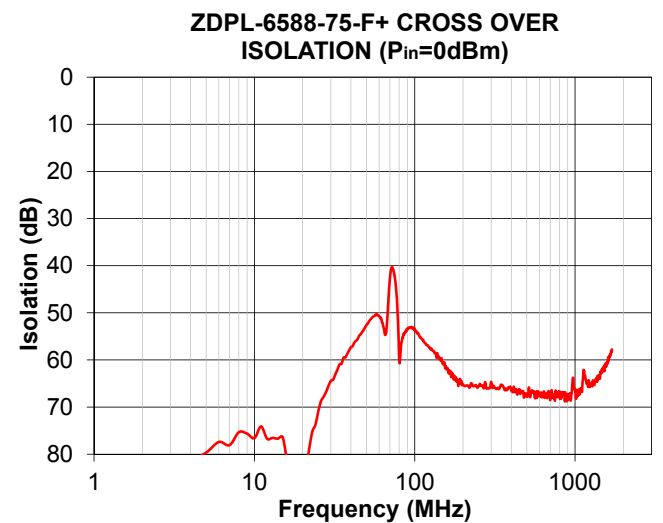
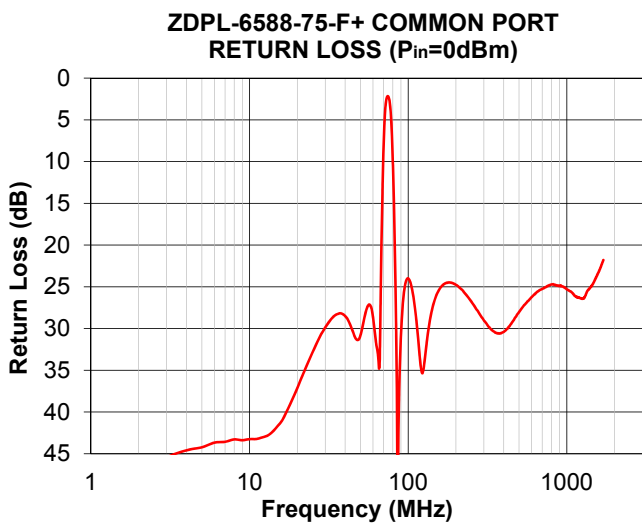
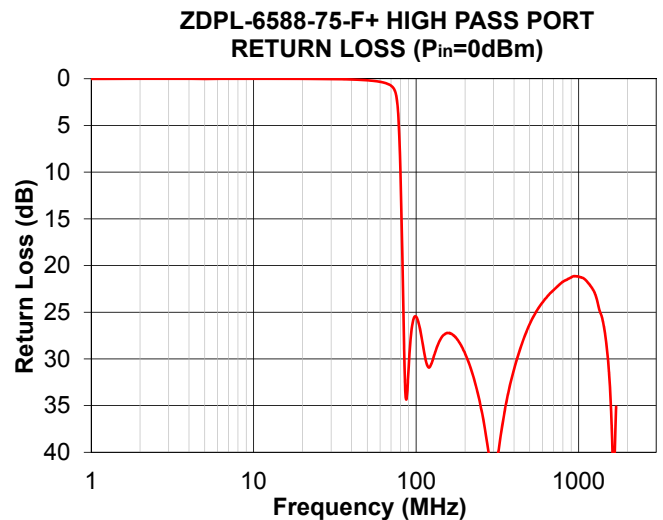
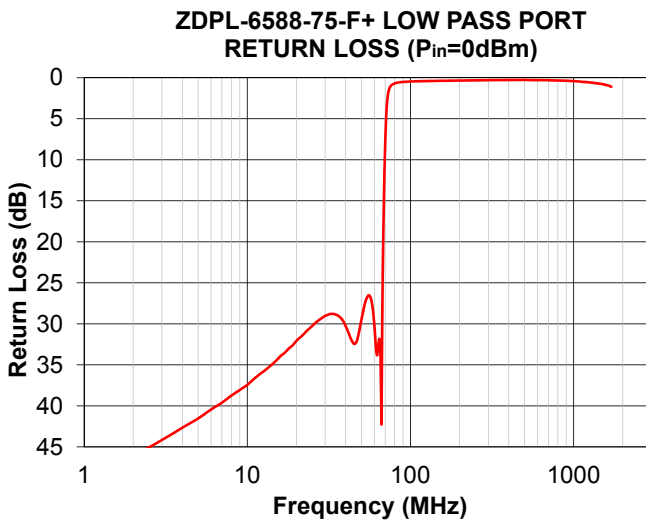
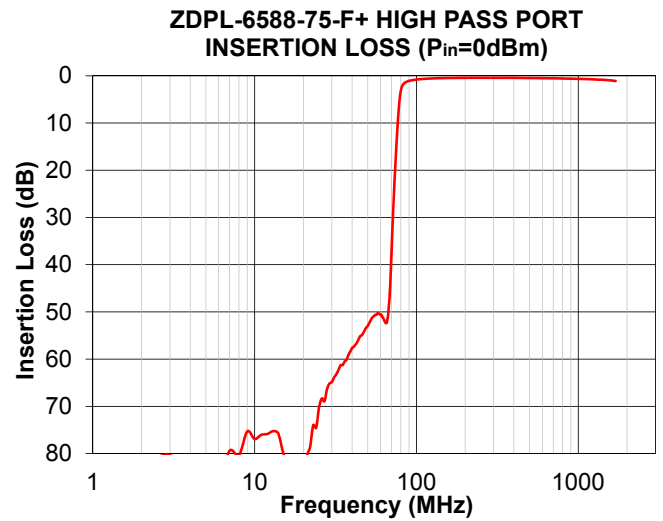
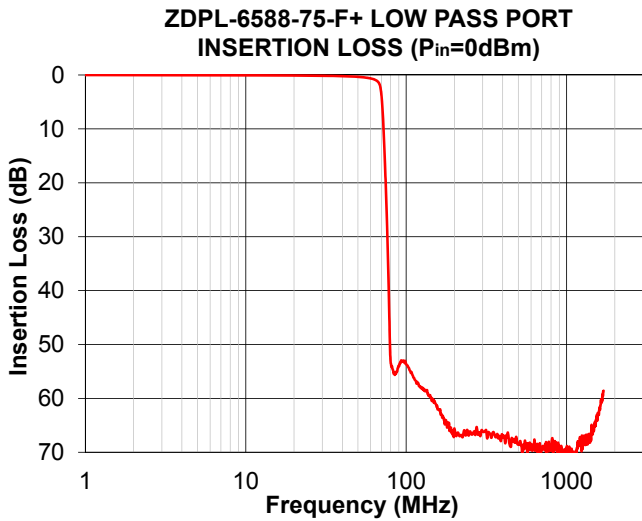

Notes

- A. Performance and quality attributes and conditions not expressly stated in this specification document are intended to be excluded and do not form a part of this specification document.
- B. Electrical specifications and performance data contained in this specification document are based on Mini-Circuit's applicable established test performance criteria and measurement instructions.
- C. The parts covered by this specification document are subject to Mini-Circuits standard limited warranty and terms and conditions (collectively, "Standard Terms"); Purchasers of this part are entitled to the rights and benefits contained therein. For a full statement of the Standard Terms and the exclusive rights and remedies thereunder, please visit Mini-Circuits' website at www.minicircuits.com/MCLStore/terms.jsp

