

Wide Bandwidth Voltage Controlled Attenuator
Package Style: MCM, 16-Pin, 1.175mm x 3.2mm x 3.2mm



Features

- Patent Pending Circuit Architecture
- Broadband 50MHz to 18,000MHz Frequency Range
- 30dB Attenuation Range
- +45dBm IIP3 Typical
- +75dBm IIP2 Typical
- High 1dB Compression Point 29dBm
- Low Supply Current 2mA Typical
- 3 to 5V Power Supply
- Linear in dB Control Characteristic
- Internal Temperature Compensation
- Class 1C ESD (1000V)
- Complete Solution in a Small 3.2mm x 3.2mm, QFN Package

Applications

- Point to Point Radio
- Test Instrumentation
- Microwave Radio
- High Linearity Power Control

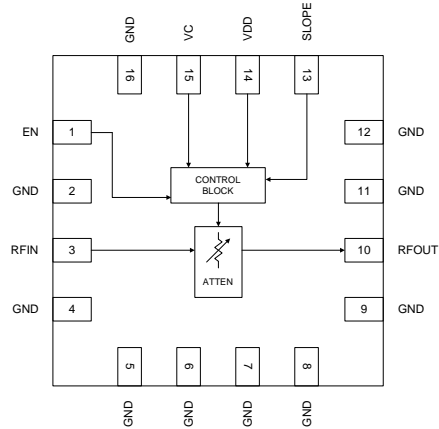

Functional Block Diagram

Product Description

RFMD's RFSA2113 is a fully monolithic analog voltage controlled attenuator (VCA) featuring exceptional linearity over a typical temperature compensated 30dB gain control range. The RFSA2113 features a wide bandwidth up to 18GHz. It incorporates a revolutionary new circuit architecture to solve a long standing industry problem: high IP3, high attenuation range, low DC current, broad bandwidth and temperature compensated linear in dB control voltage characteristic. This voltage controlled attenuator is controlled by a single positive control voltage with on chip DC conditioning circuitry. The slope polarity of the control voltage versus gain is selectable. The RFSA2113 draws a very low 2mA current. This attenuator is matched to 50Ω over its rated control range and frequency with no external matching components required. Typical VCA's in this performance are based on compound semiconductor GaAs FET MMICs that require 1 to 2 negative voltages for control. This game changing product incorporates the complete solution in a small 3.2mm x 3.2mm MCM package that reduces the footprint in area and simplifies the control aspects over conventional compound semiconductor attenuator approaches.

Ordering Information

RFSA2113SR	7" Reel with 100 pieces
RFSA2113SQ	Sample bag with 25 pieces
RFSA2113TR13	13" Reel with 2500 pieces
RFSA2113PCK-410	50MHz to 18,000MHz PCBA with 5-piece sample bag

Absolute Maximum Ratings

Parameter	Rating	Unit
Supply Voltage (V_{DD})	-0.5 to 6	V
SLOPE, VC, EN Pins	-0.5 to 6	V
RF Input Power ^{Note 1}	+23	dBm
Operating Temperature	-40 to +85	°C
Storage Temperature	-55 to +150	°C
Junction Temperature	+125	°C
ESD Rating (HBM)	1000	V

Note 1: Peak power of +29dBm allowable when RMS power does not exceed +23dBm.



Caution! ESD sensitive device.

Exceeding any one or a combination of the Absolute Maximum Rating conditions may cause permanent damage to the device. Extended application of Absolute Maximum Rating conditions to the device may reduce device reliability. Specified typical performance or functional operation of the device under Absolute Maximum Rating conditions is not implied.

RoHS status based on EU Directive 2011/65/EU (at time of this document revision).

The information in this publication is believed to be accurate and reliable. However, no responsibility is assumed by RF Micro Devices, Inc. ("RFMD") for its use, nor for any infringement of patents, or other rights of third parties, resulting from its use. No license is granted by implication or otherwise under any patent or patent rights of RFMD. RFMD reserves the right to change component circuitry, recommended application circuitry and specifications at any time without prior notice.

Parameter	Specification			Unit	Condition
	Min.	Typ.	Max.		
General					
Supply Voltage	3.0	5	5.5	V	Internal Voltage Regulator
Supply Current		2	3.5	mA	
Operating Temperature	-40		85	°C	
Thermal Resistance		175		°C/W	RF input must be RFIN pin
RF Input Power			23	dBm	Continuous RMS operation at the RFIN pin
RF Performance					
Frequency Range	50		18000	MHz	
Minimum Insertion Loss		2		dB	1GHz
		3		dB	10GHz
		4.5		dB	18GHz
Gain Control Range		34		dB	1GHz
		32		dB	10GHz
		28		dB	18GHz
Gain vs. Temperature		1		dB	Peak to peak gain variation over temperature for fixed control voltage
Return Loss		15		dB	
Relative Phase		22		Deg	Insertion phase at 15dB attenuation relative to minimum insertion loss
Input 1dB Compression Point		29		dBm	Peak power of +29dBm allowable when RMS power does not exceed +23dBm
Input IP3		45		dBm	$P_{IN} + (IM3_{dBC}/2)$
Input IP2		75		dBm	$P_{IN} + IM2_{dBC}$, IM2 is F1+F2
Input IH2		80		dBm	$P_{IN} + H2_{dBC}$, H2 is second harmonic
Input IH3		50		dBm	$P_{IN} + (H3_{dBC}/2)$, H3 is third harmonic
Control					
Voltage Control Range, Positive Attenuation Slope	0		2.5	V	2.5V control voltage is lowest insertion loss, SLOPE pin logic high
Voltage Control Range, Negative Attenuation Slope	0		2.5	V	0V control voltage is lowest insertion loss, SLOPE pin logic low
Voltage Control Pin Current		1.2		μA	VC pin set to 2.5V
SLOPE and EN Pins Logic Low			0.4	V	
SLOPE and EN Pins Logic High	1			V	
Settling Time			2	μsec	1dB attenuation change settling within 0.1dB of final value.

Note: Typical performance at nominal conditions unless otherwise noted: Supply voltage=5.0V, Operating temperature=25 °C, RF Frequency 10GHz

Measured Positive Attenuation Slope Performance

Note: Data includes PCB and connector losses except for the top two plots on this page.

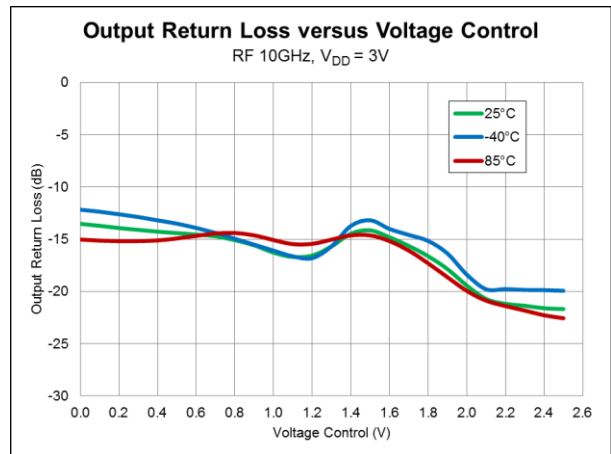
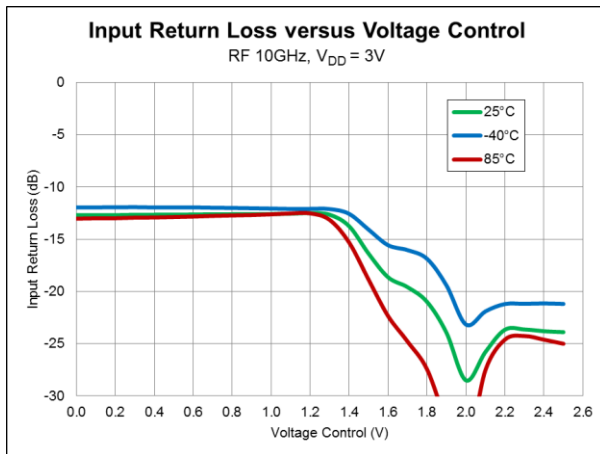
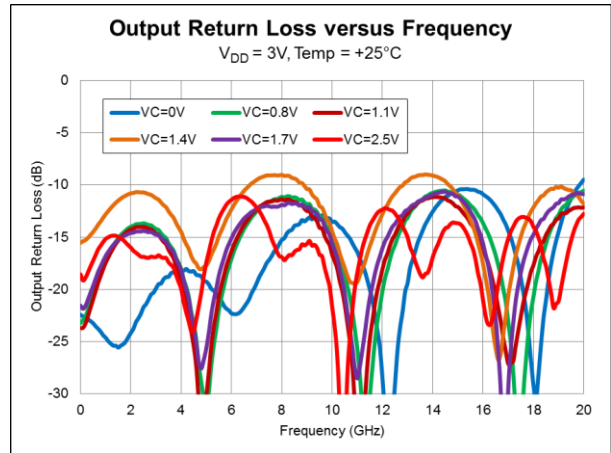
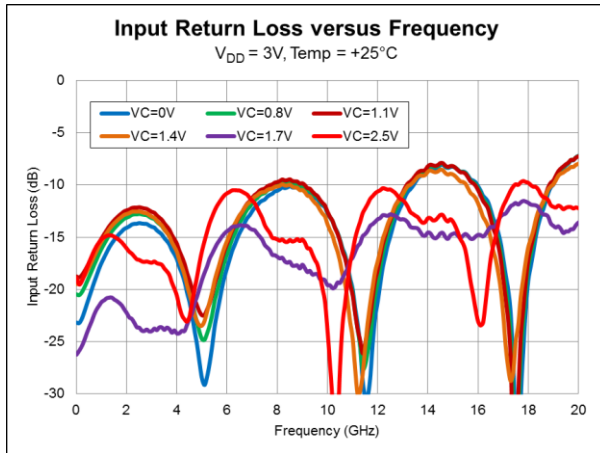
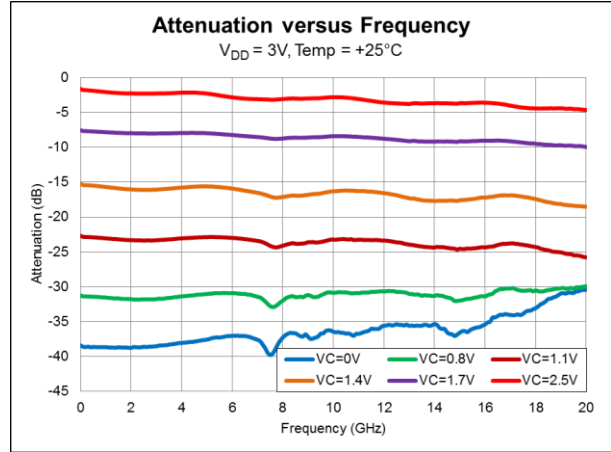
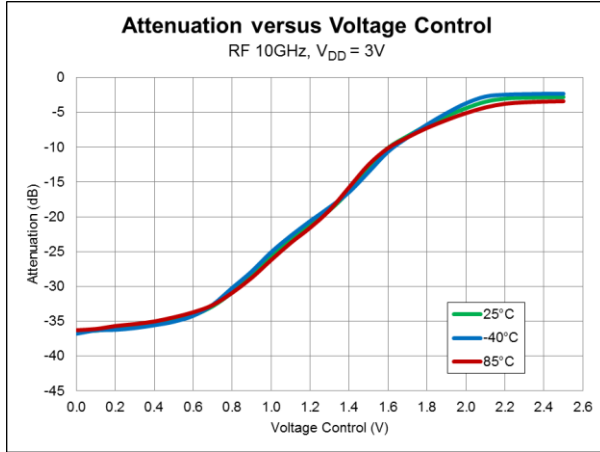

Measured Positive Attenuation Slope Performance

Note: Data includes PCB and connector losses

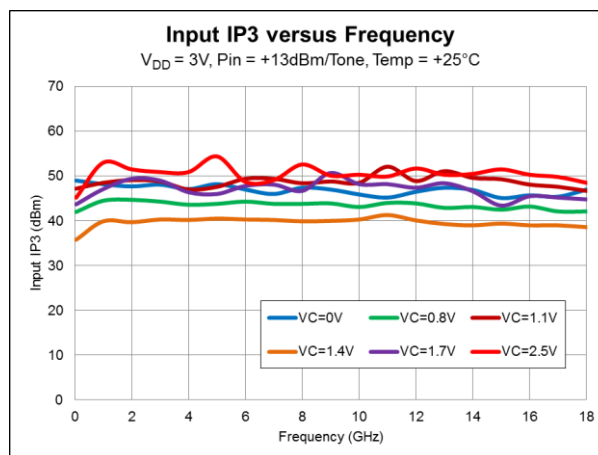
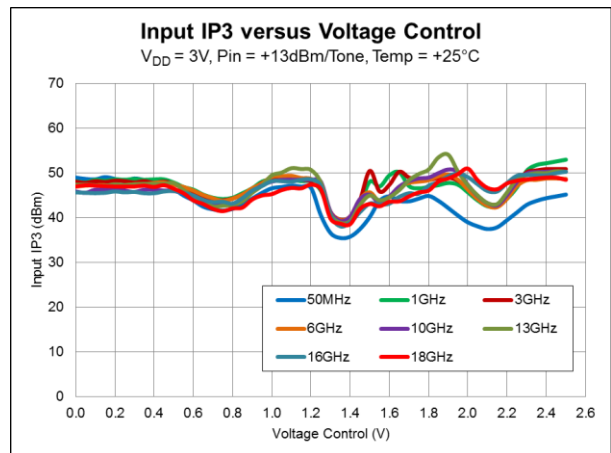
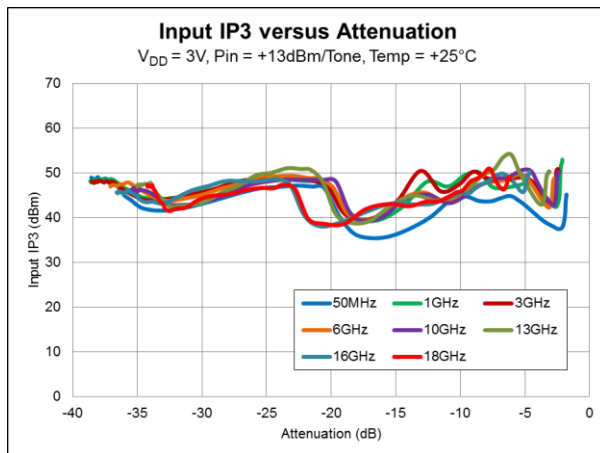
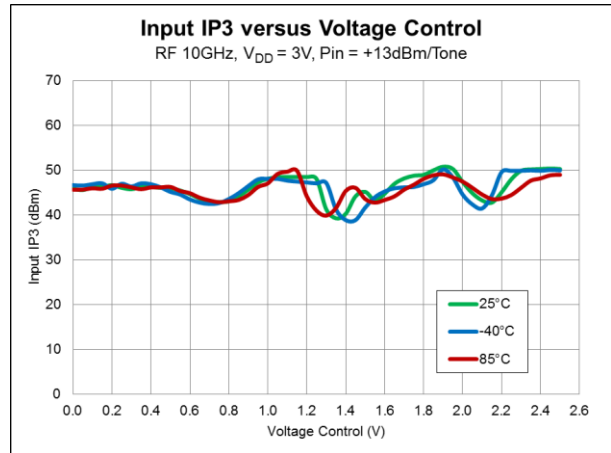
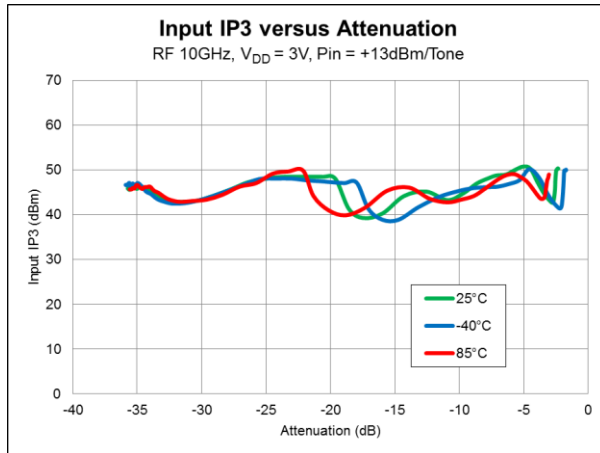

Measured Positive Attenuation Slope Performance

Note: Data includes PCB and connector losses

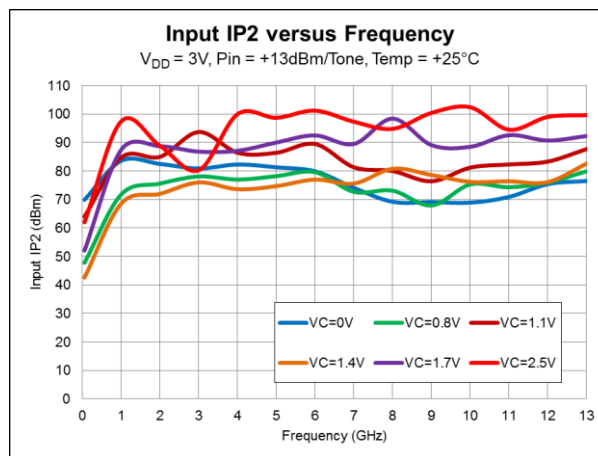
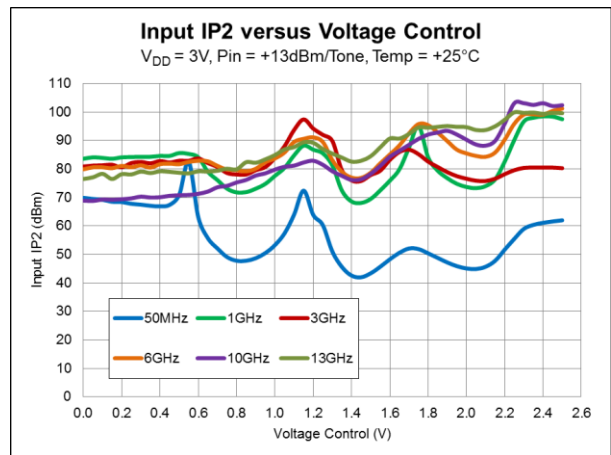
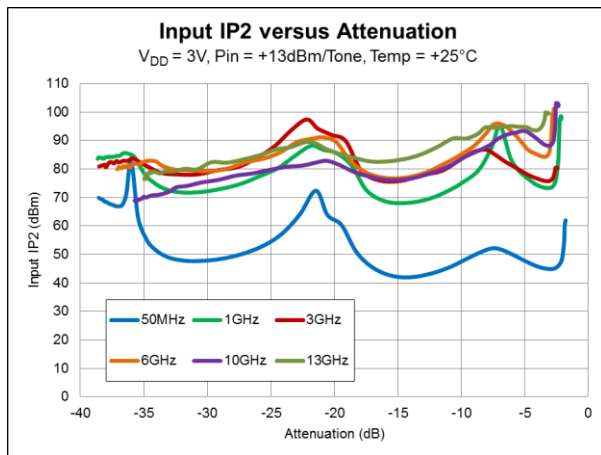
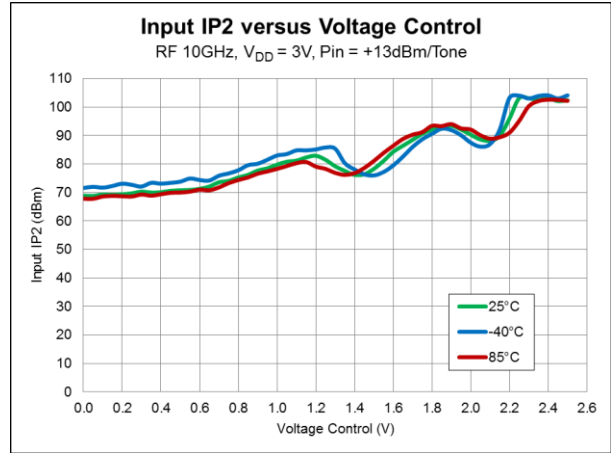
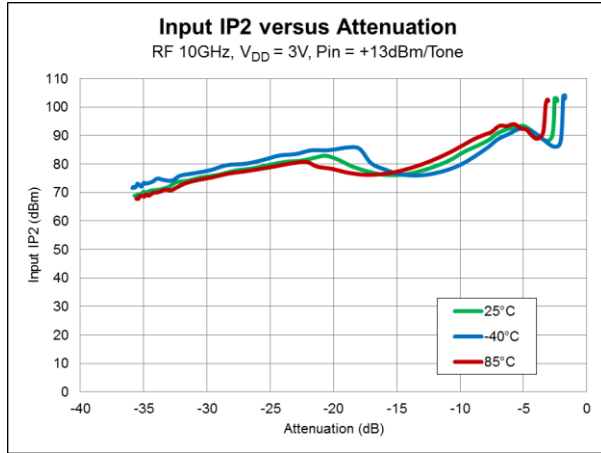

Measured Positive Attenuation Slope Performance

Note: Data includes PCB and connector losses

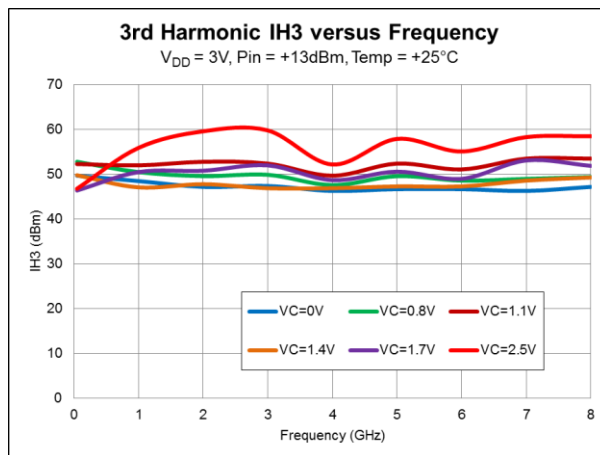
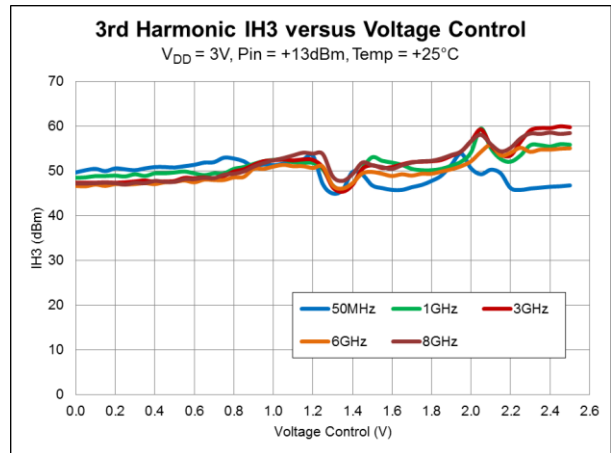
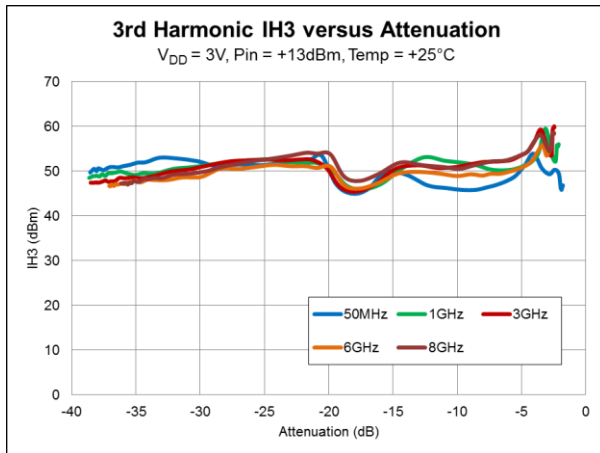
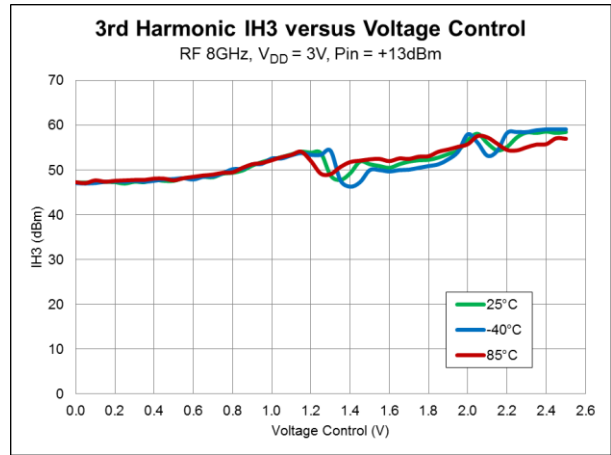
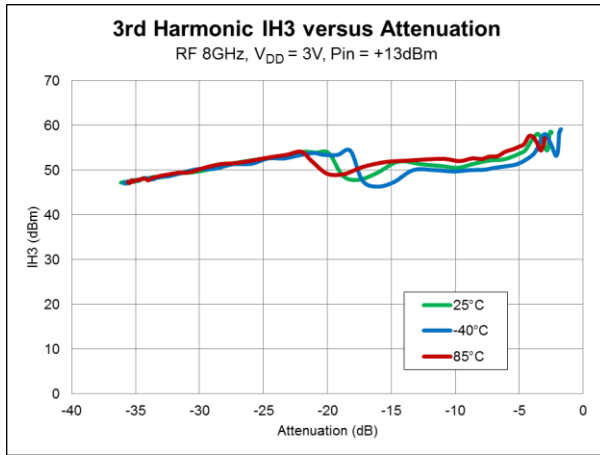

Measured Positive Attenuation Slope Performance

Note: Data includes PCB and connector losses

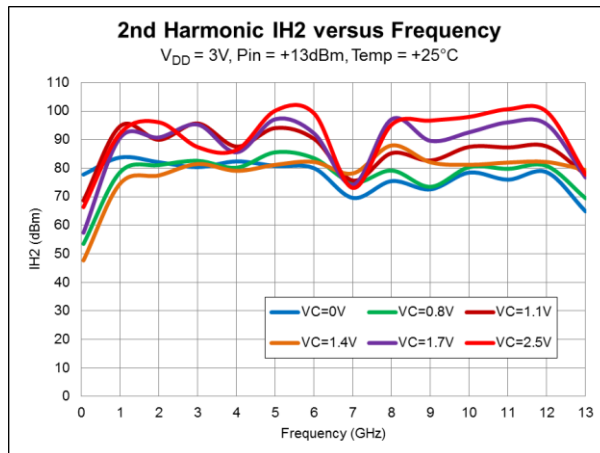
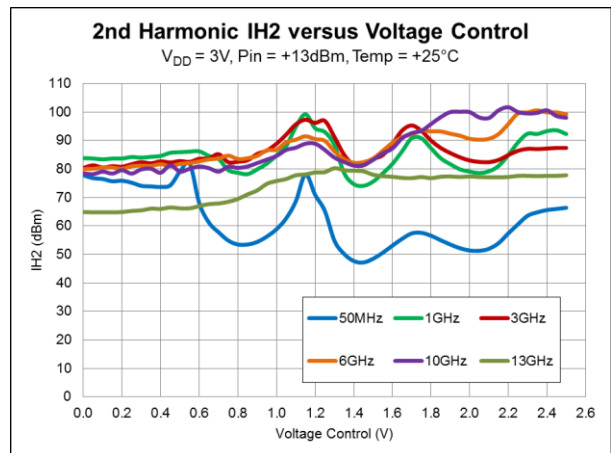
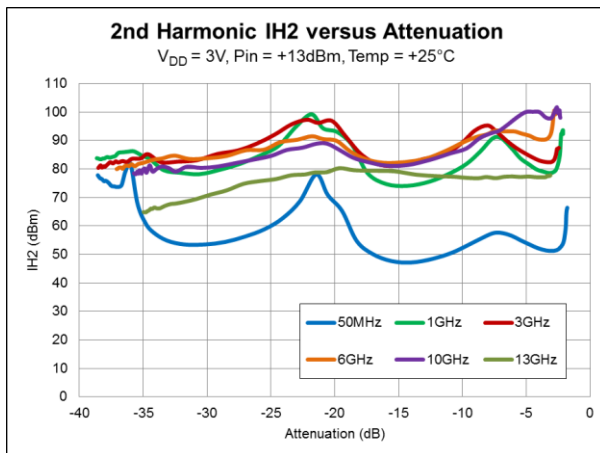
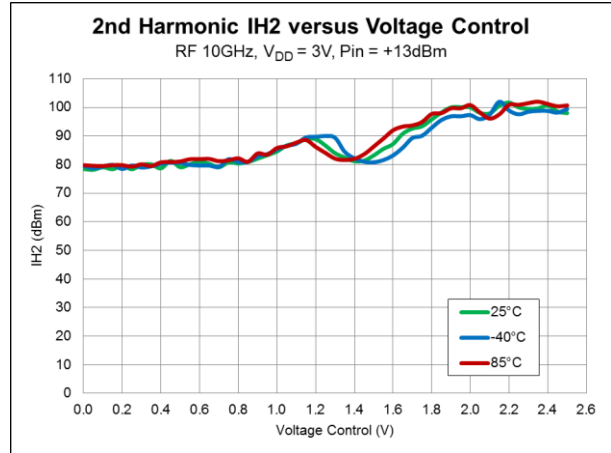
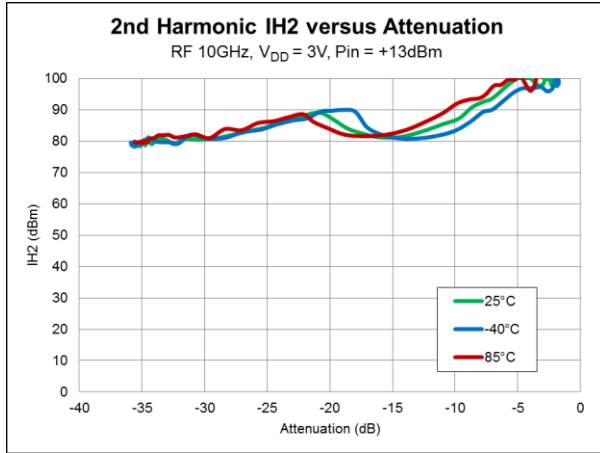

Measured Positive Attenuation Slope Performance

Note: Data includes PCB and connector losses

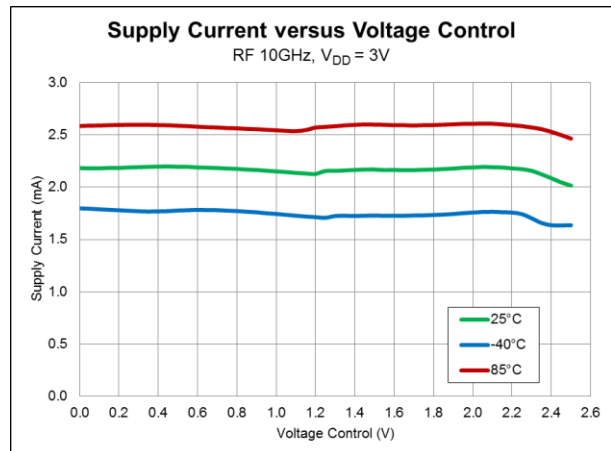
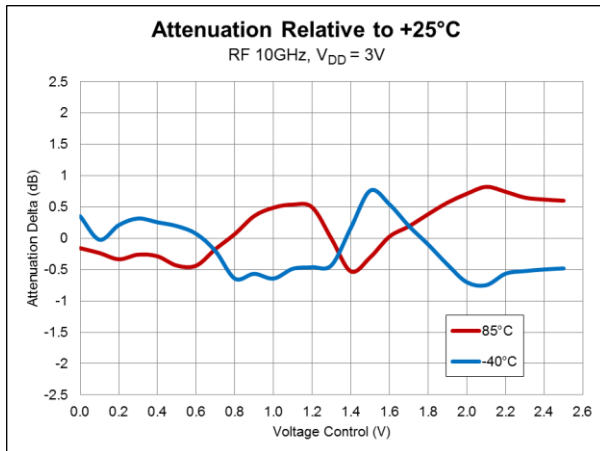
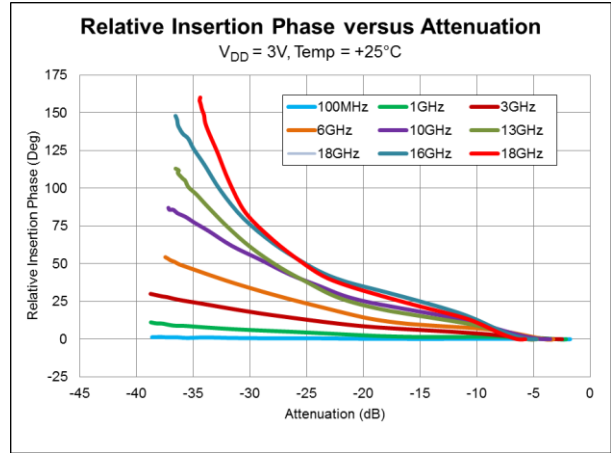
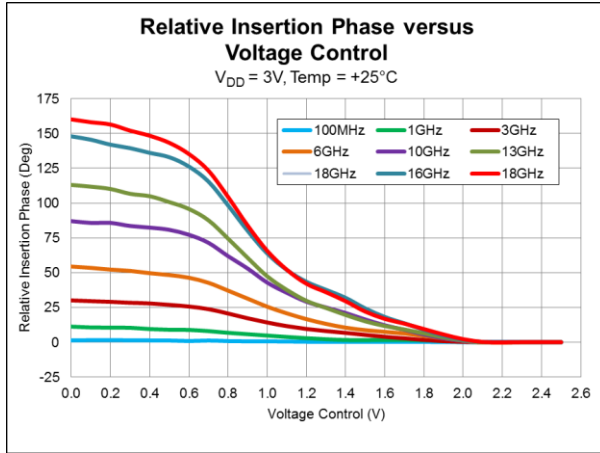

Measured Negative Attenuation Slope Performance

Note: Data includes PCB and connector losses except for the top two plots on this page.

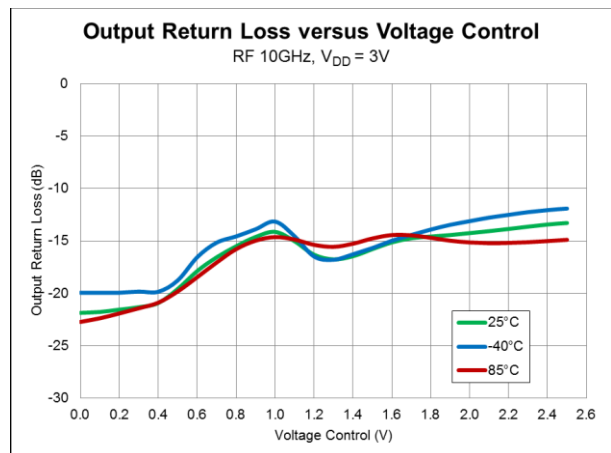
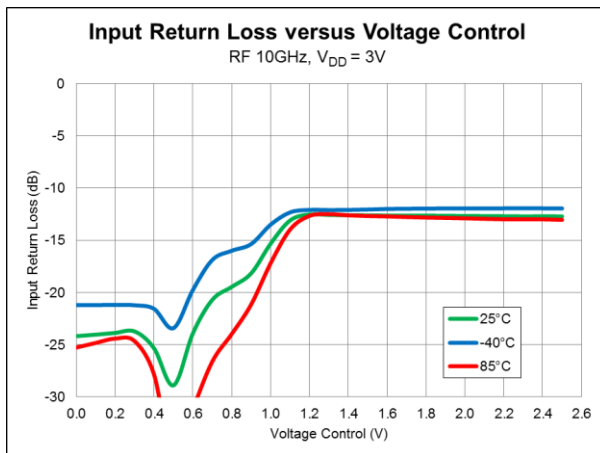
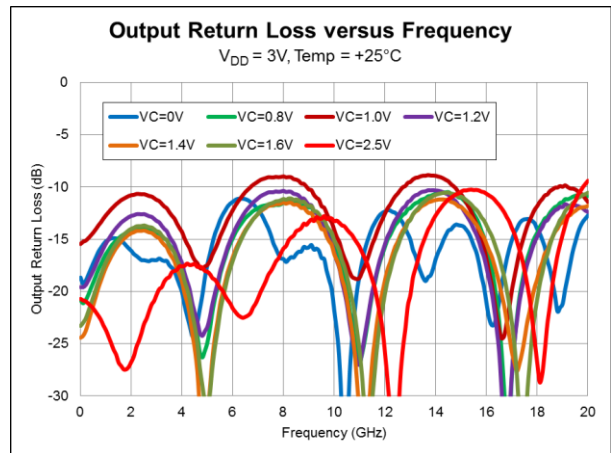
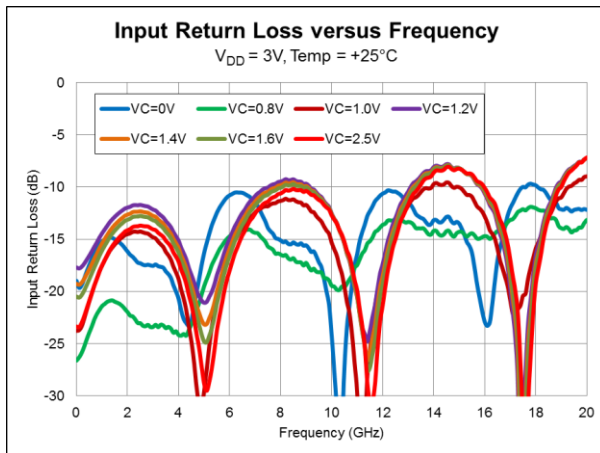
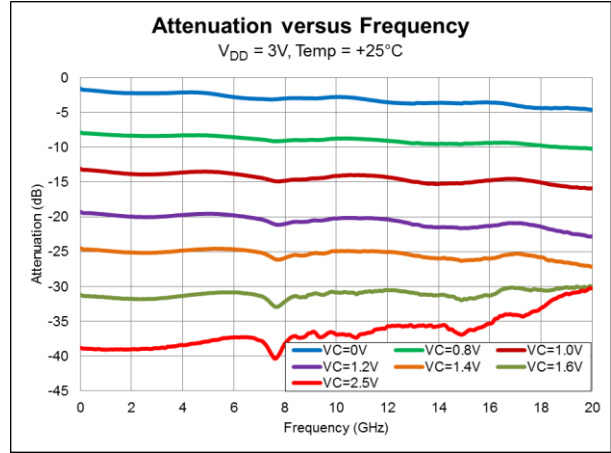
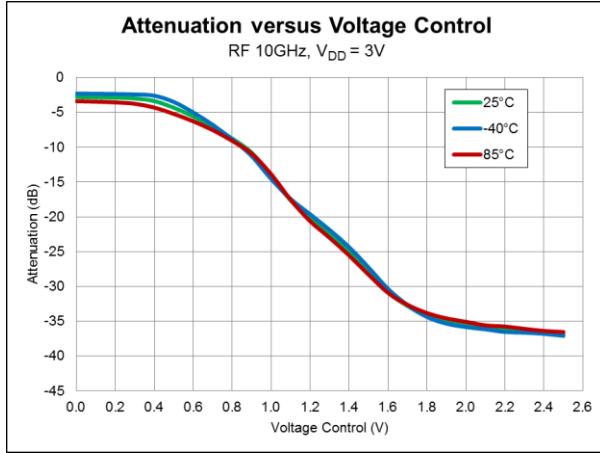

Measured Negative Attenuation Slope Performance

Note: Data includes PCB and connector losses

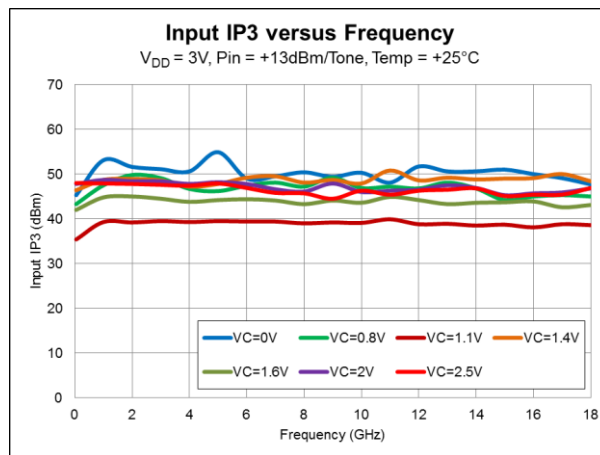
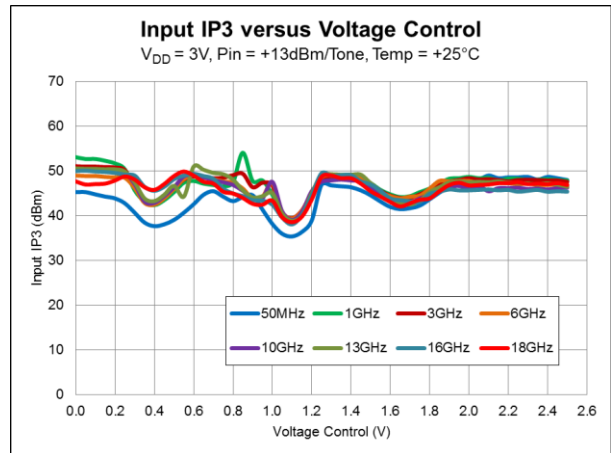
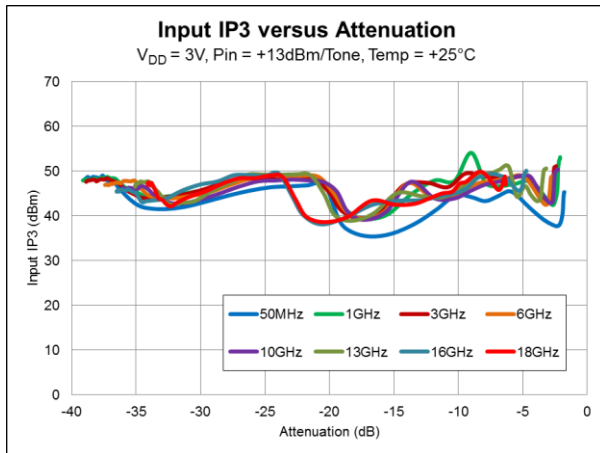
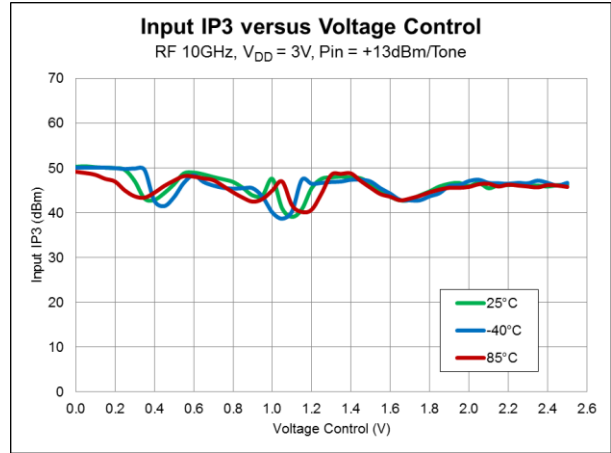
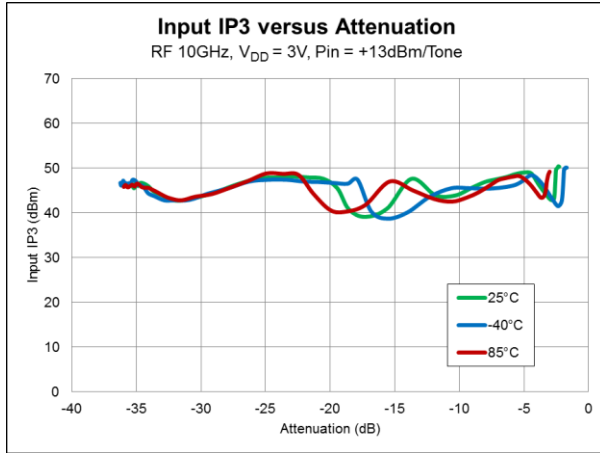

Measured Negative Attenuation Slope Performance

Note: Data includes PCB and connector losses

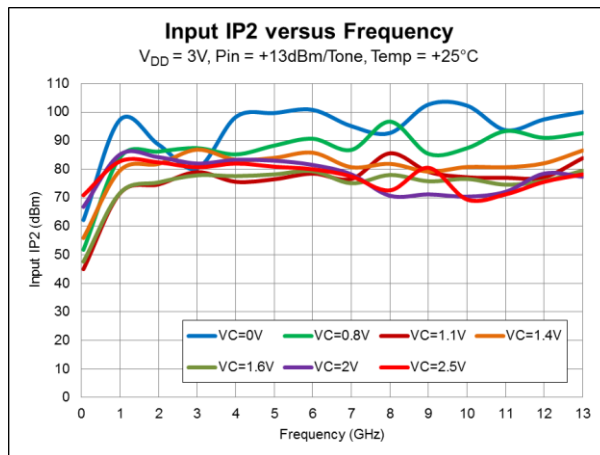
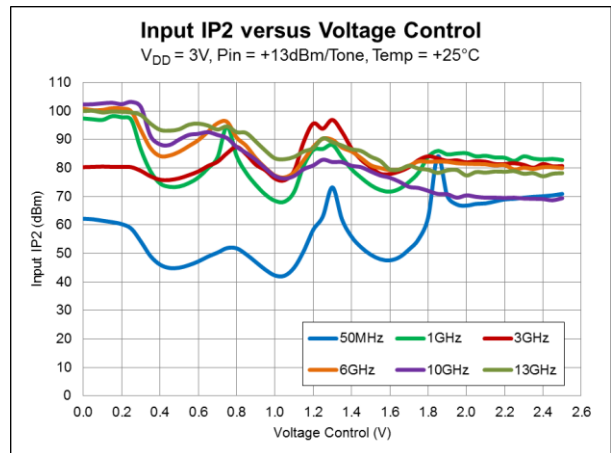
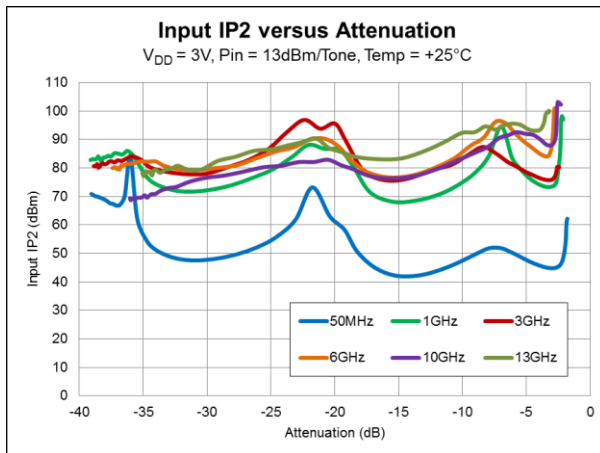
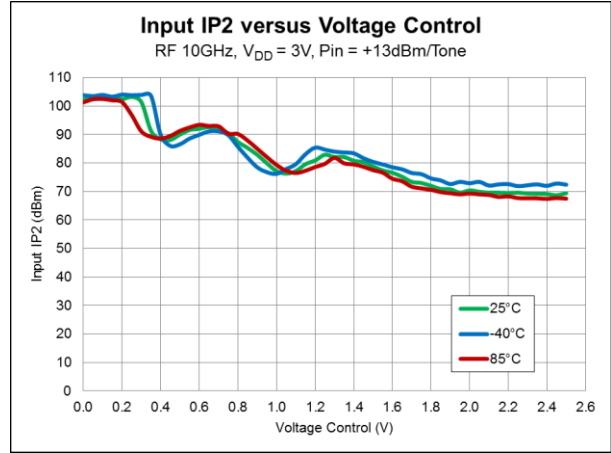
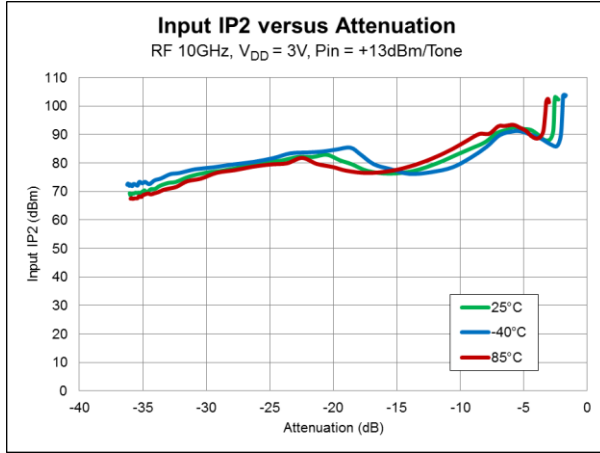

Measured Negative Attenuation Slope Performance

Note: Data includes PCB and connector losses

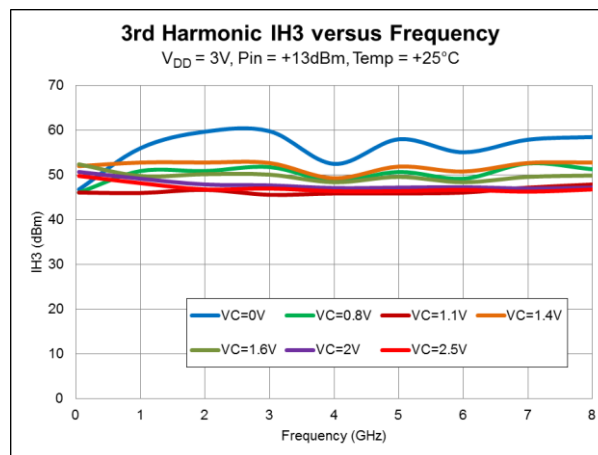
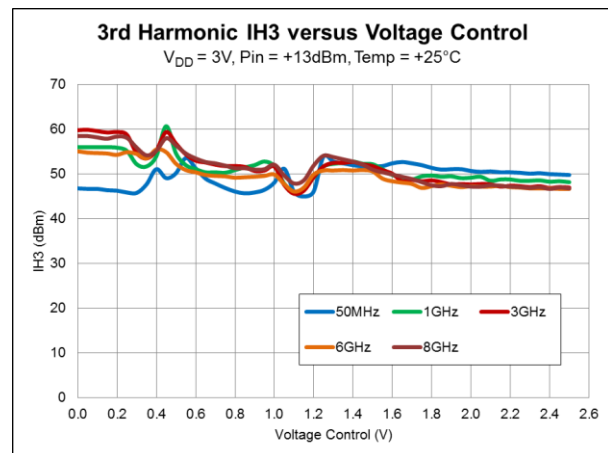
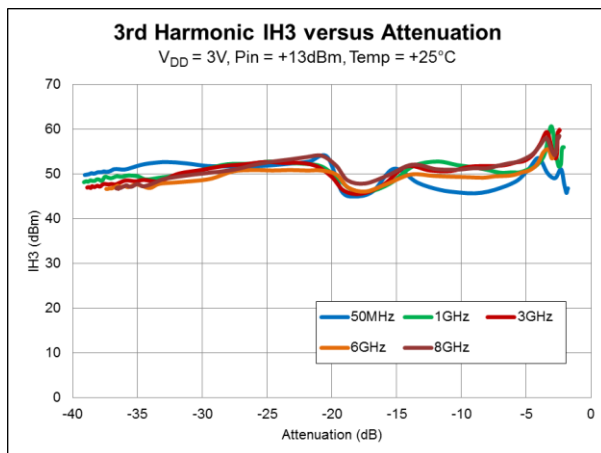
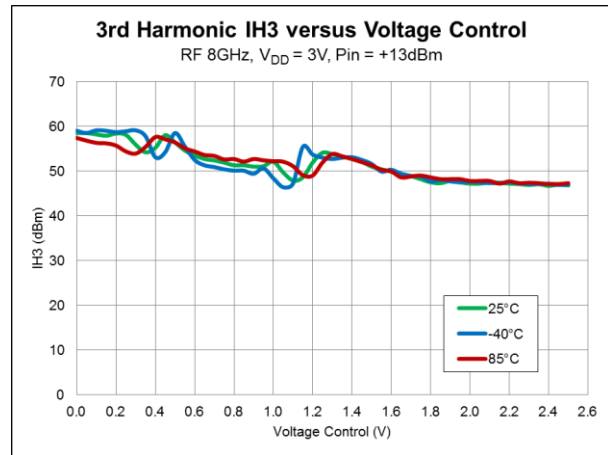
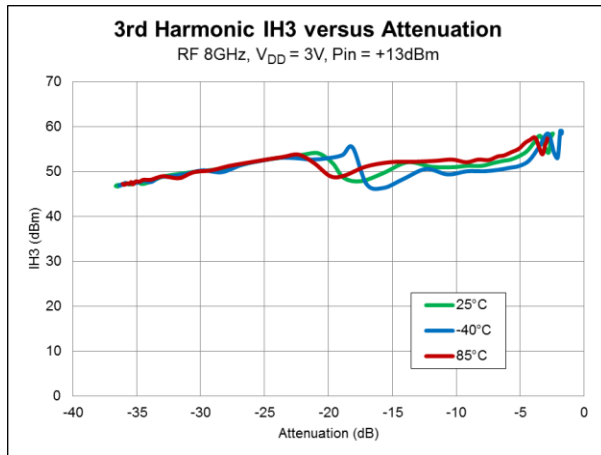

Measured Negative Attenuation Slope Performance

Note: Data includes PCB and connector losses

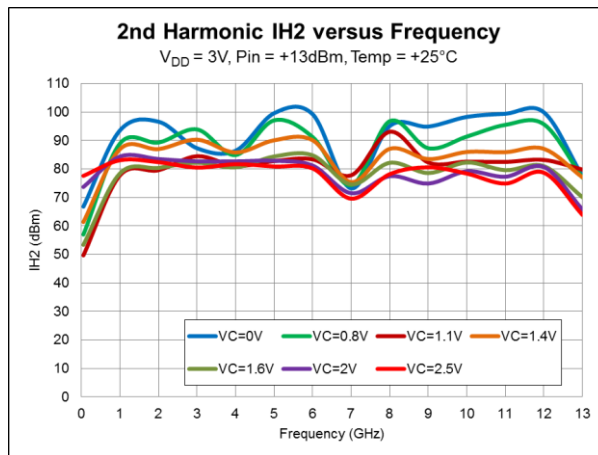
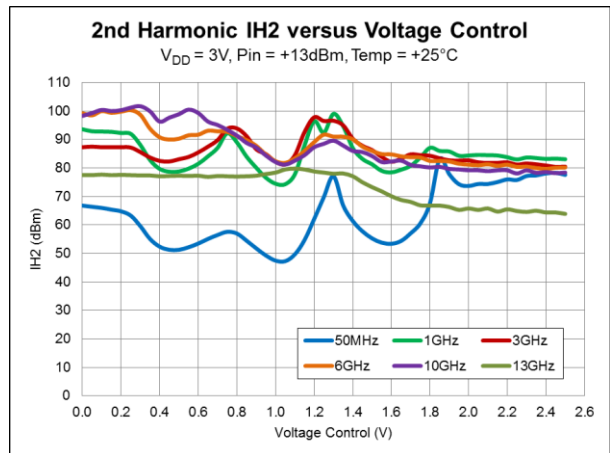
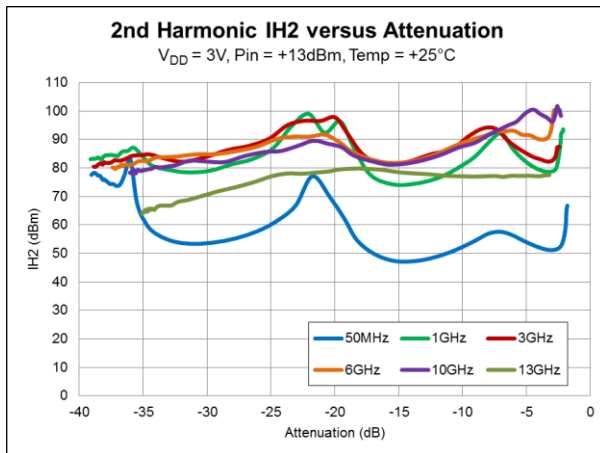
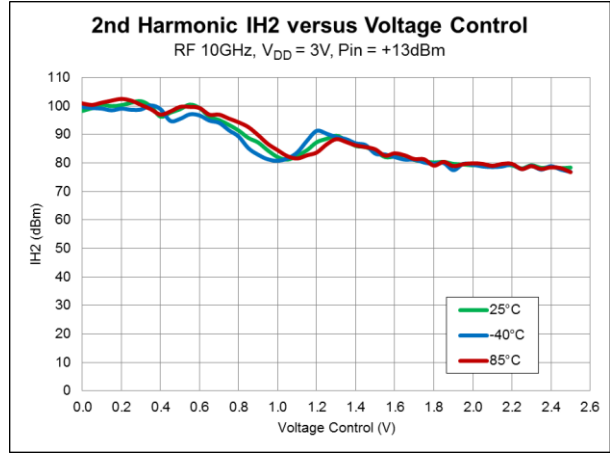
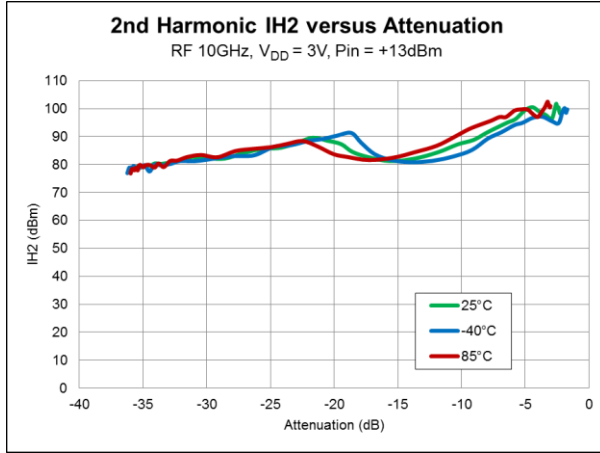

Measured Negative Attenuation Slope Performance

Note: Data includes PCB and connector losses

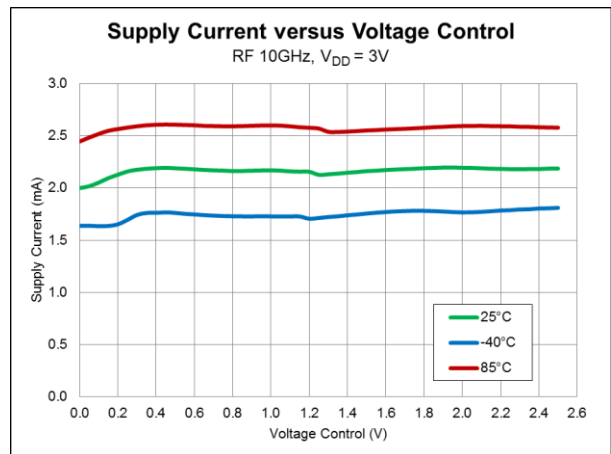
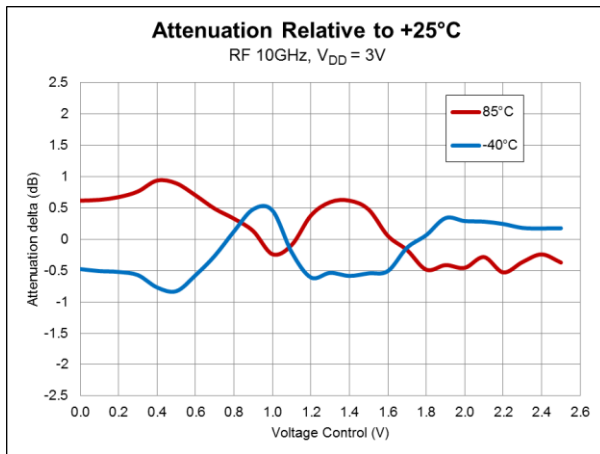
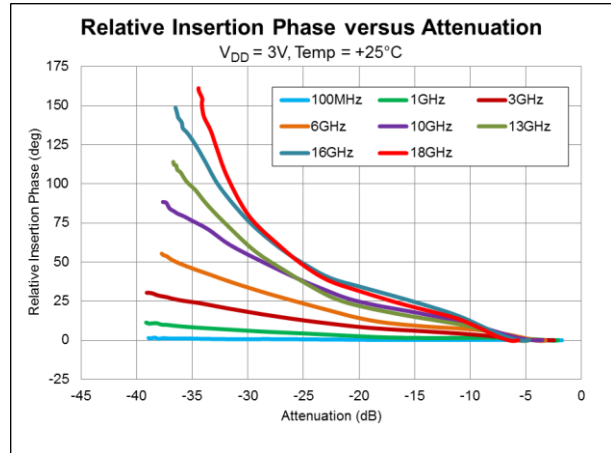
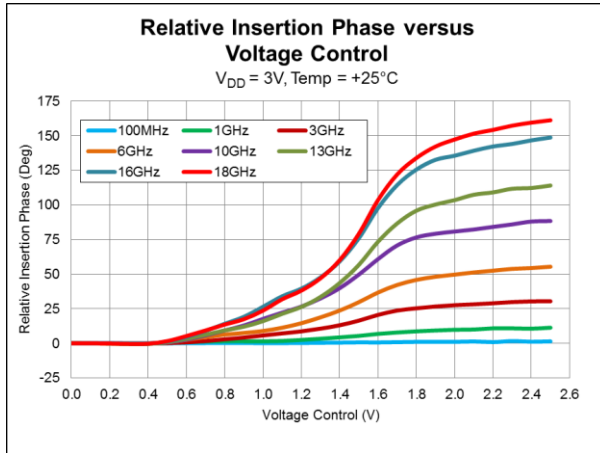

Evaluation Board Schematic

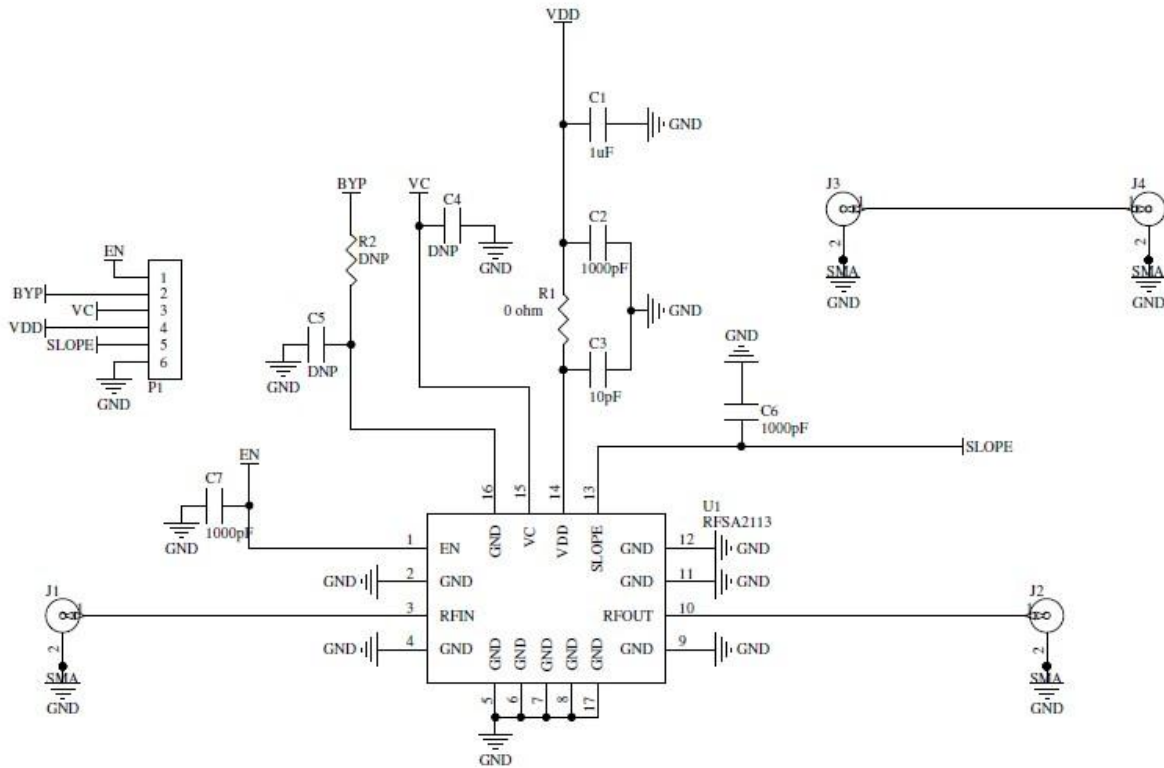

Evaluation Board Bill of Materials (BOM)

Description	Reference Designator	Manufacturer	Manufacturer's P/N
Voltage Controlled Attenuator VCA	U1	RFMD	RFSA2113
CONN, SMA, END LNCH, RND PIN, 0.039"	J1-J4	Gigalane Co., Ltd.	PSF-S01-002
CONN, HDR, ST, 6-PIN, 0.100", T/H	P1	Molex	22-28-4063
SA2113-410 Evaluation Board		DDI	SA2113-410(A)
CAP, 1000pF, 10%, 25V, X7R, 0402	C2, C6-C7	Murata Electronics	GRM155R71H102KA01D
CAP, 1µF, 10%, 16V, X7R, 1206	C1	Murata Electronics	GRM31MR71E105KC01L
CAP, 10pF, 5%, 50V, COG, 0402	C3	Murata Electronics	GRM1555C1H100JZ01E
RES, 0Ω, 0402	R1	Kamaya, Inc	RMC1/16SJPTH
DNP	R2	N/A	N/A
DNP	C4-C5	N/A	N/A

Evaluation Board Assembly Drawing

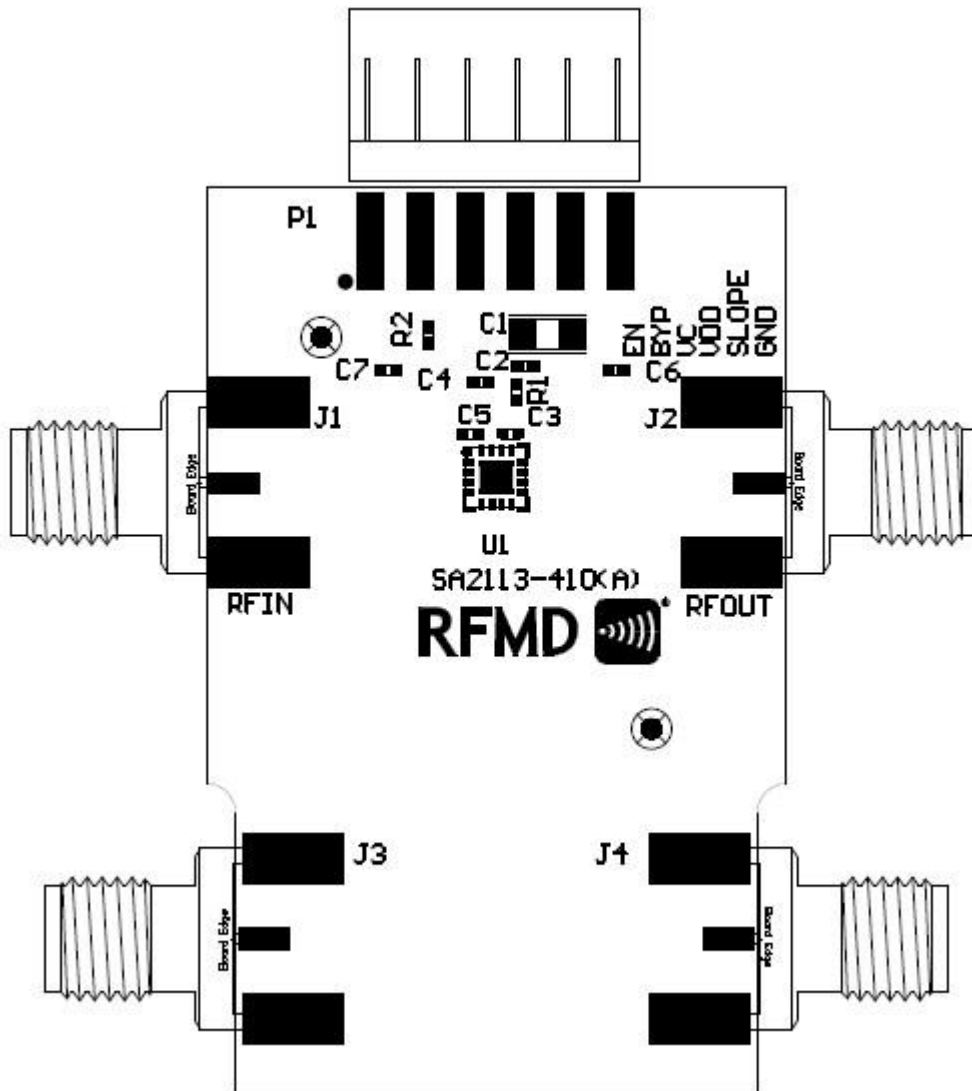

Pin Names and Description

Pin	Function	Description
1	EN	Supply Current Enable Control Connect to Logic Low to Enable Connect to Logic High to Disable
2	GND	Ground Pin
3	RFIN	RF Input. Use External DC Block. RF input must be this pin to ensure linearity and thermal resistance specifications.
4	GND	Ground Pin
5	GND	Ground Pin
6	GND	Ground Pin
7	GND	Ground Pin
8	GND	Ground Pin
9	GND	Ground Pin
10	RFOUT	RF Output. Use External DC Block. RF output must be this pin to ensure linearity and thermal resistance specifications.
11	GND	Ground Pin
12	GND	Ground Pin
13	SLOPE	Attenuation Slope Control Connect to Logic Low to Enable Negative Attenuation Slope Connect to Logic High to Enable Positive Attenuation Slope
14	VDD	Supply Voltage
15	VC	Attenuator Control Voltage
16	GND	Ground Pin
GND	GND	Exposed Package Ground Paddle is RF and DC Ground

Package Drawing

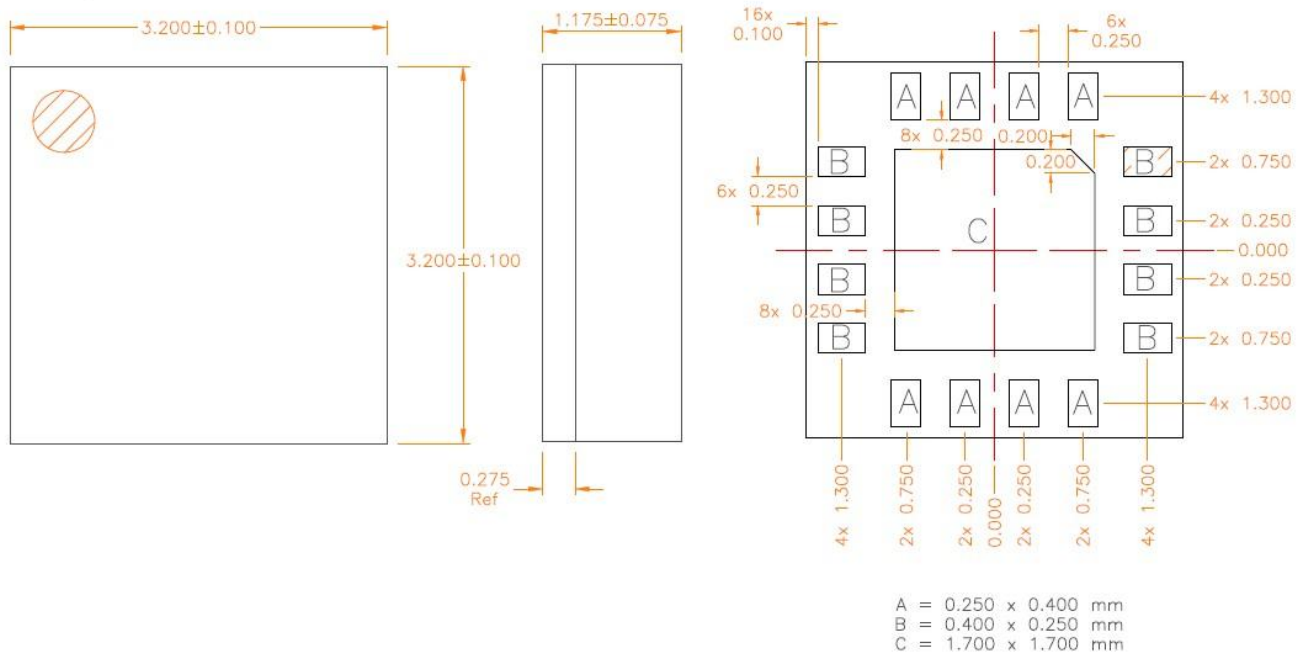

Branding Diagram

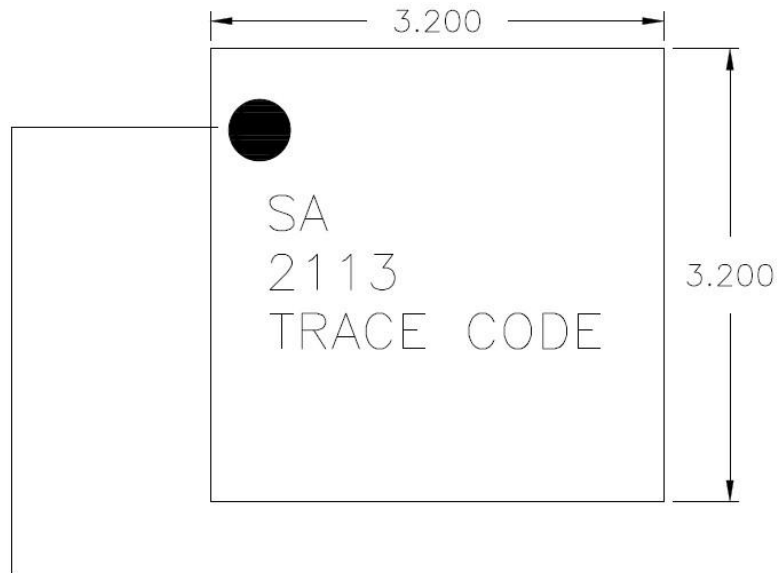

Pin 1 Indicator