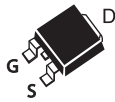
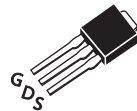
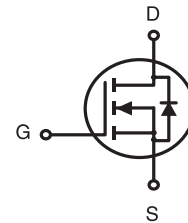

**N-Channel Logic Level Enhancement Mode Field Effect Transistor****PRODUCT SUMMARY**

VDSS	ID	RDS(ON) (mΩ) Max
60V	30A	20 @VGS=10V

FEATURES

- Super high dense cell design for low RDS(ON).
- Rugged and reliable.
- TO-252 and TO-251 Package.

STU SERIES
TO-252AA(D-PAK)STD SERIES
TO-251(I-PAK)**ABSOLUTE MAXIMUM RATINGS (T_C=25°C unless otherwise noted)**

Symbol	Parameter	Limit	Units
V _{DS}	Drain-Source Voltage	60	V
V _{GS}	Gate-Source Voltage	±20	V
I _D	Drain Current-Continuous ^a	T _C =25°C	30
		T _C =70°C	24
I _{DM}	-Pulsed ^a	88	A
E _{AS}	Single Pulse Avalanche Energy ^c	100	mJ
P _D	Maximum Power Dissipation	T _C =25°C	42
		T _C =70°C	27
T _J , T _{STG}	Operating Junction and Storage Temperature Range	-55 to 150	°C

THERMAL CHARACTERISTICS

R _{θJC}	Thermal Resistance, Junction-to-Case	3	°C/W
R _{θJA}	Thermal Resistance, Junction-to-Ambient	50	°C/W

STU664S

STD664S

Ver 1.0

ELECTRICAL CHARACTERISTICS (T_c=25°C unless otherwise noted)

Symbol	Parameter	Conditions	Min	Typ	Max	Units
OFF CHARACTERISTICS						
BV _{DSS}	Drain-Source Breakdown Voltage	V _{GS} =0V , I _D =250uA	60			V
I _{DSS}	Zero Gate Voltage Drain Current	V _{DS} =48V , V _{GS} =0V			1	uA
I _{GSS}	Gate-Body Leakage Current	V _{GS} = ±20V , V _{DS} =0V			±100	nA
ON CHARACTERISTICS						
V _{GS(th)}	Gate Threshold Voltage	V _{DS} =V _{GS} , I _D =250uA	2	2.6	4	V
R _{DS(ON)}	Drain-Source On-State Resistance	V _{GS} =10V , I _D =15A		16	20	m ohm
g _{FS}	Forward Transconductance	V _{DS} =10V , I _D =15A		22		S
DYNAMIC CHARACTERISTICS ^b						
C _{ISS}	Input Capacitance	V _{DS} =25V, V _{GS} =0V f=1.0MHz		2190		pF
C _{OSS}	Output Capacitance			140		pF
C _{RSS}	Reverse Transfer Capacitance			105		pF
SWITCHING CHARACTERISTICS ^b						
t _{D(ON)}	Turn-On Delay Time	V _{DD} =30V I _D =1A V _{GS} =10V R _{GEN} = 6 ohm		47		ns
t _r	Rise Time			31		ns
t _{D(OFF)}	Turn-Off Delay Time			62		ns
t _f	Fall Time			13		ns
Q _g	Total Gate Charge	V _{DS} =30V, I _D =15A, V _{GS} =10V		36		nC
Q _{gs}	Gate-Source Charge	V _{DS} =30V, I _D =15A, V _{GS} =10V		6		nC
Q _{gd}	Gate-Drain Charge			12		nC
DRAIN-SOURCE DIODE CHARACTERISTICS AND MAXIMUM RATINGS						
V _{SD}	Diode Forward Voltage	V _{GS} =0V, I _S =6A		0.81	1.3	V

Notes

- Drain current limited by maximum junction temperature.
- Guaranteed by design, not subject to production testing.
- Starting T_J=25°C, L=0.5mH, V_{DD} = 30V. (See Figure13)

Jun,05,2013

STU664S STD664S

Ver 1.0

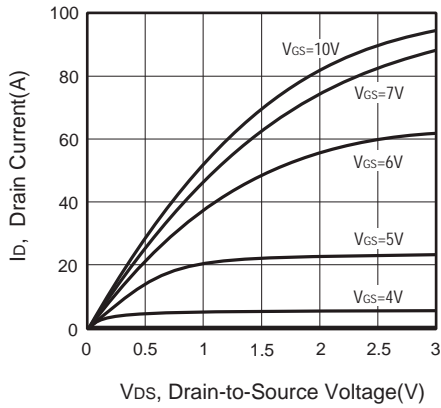

Figure 1. Output Characteristics

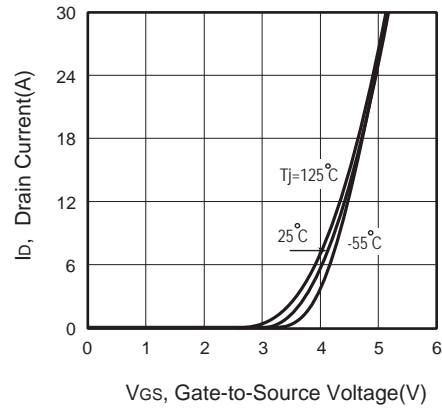

Figure 2. Transfer Characteristics

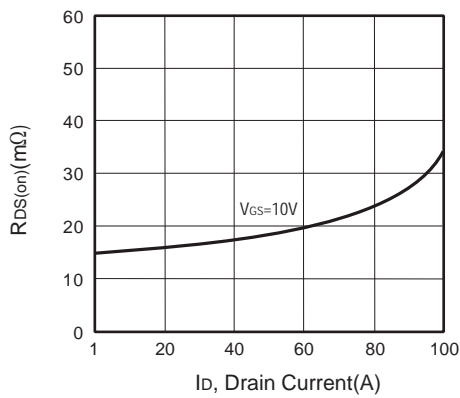

Figure 3. On-Resistance vs. Drain Current and Gate Voltage

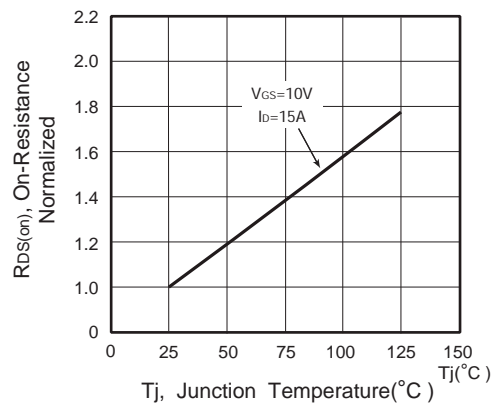

Figure 4. On-Resistance Variation with Drain Current and Temperature

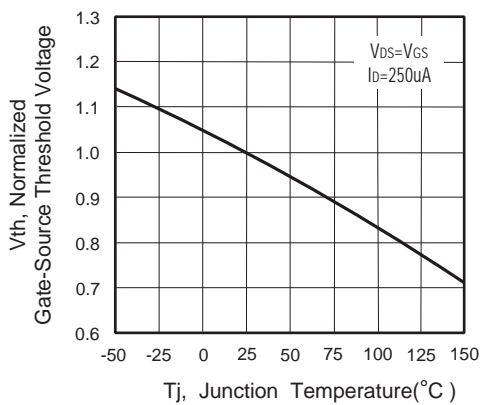

Figure 5. Gate Threshold Variation with Temperature

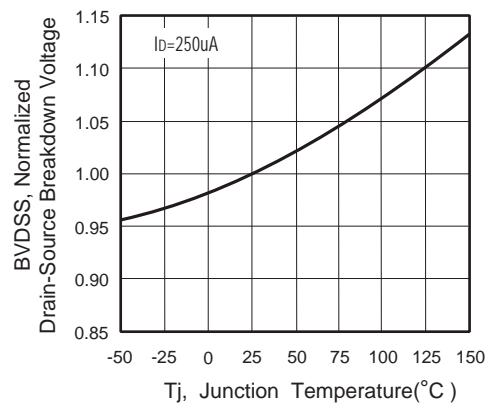

Figure 6. Breakdown Voltage Variation with Temperature

Jun,05,2013

STU664S STD664S

Ver 1.0

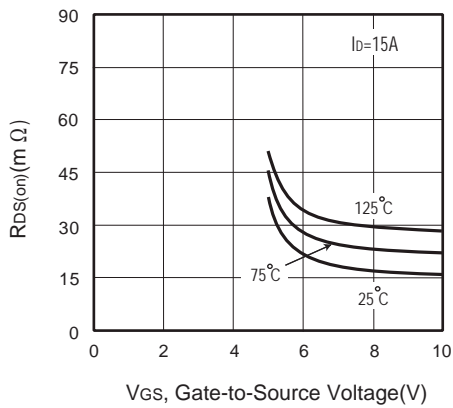

Figure 7. On-Resistance vs. Gate-Source Voltage

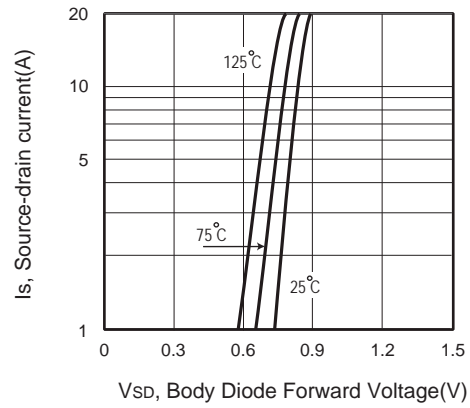

Figure 8. Body Diode Forward Voltage Variation with Source Current

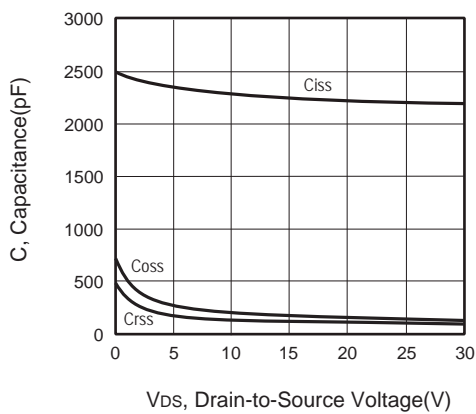

Figure 9. Capacitance

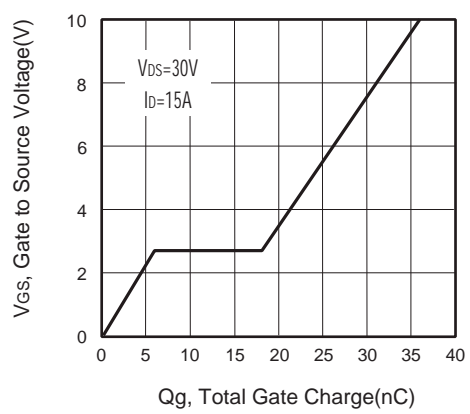

Figure 10. Gate Charge

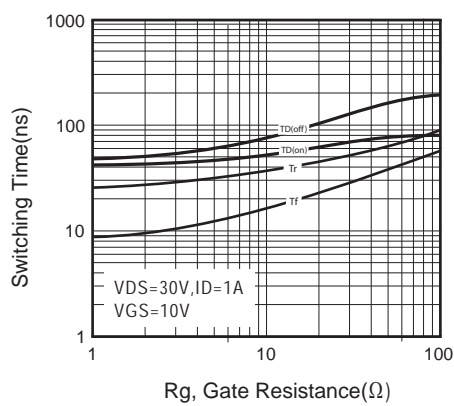

Figure 11. switching characteristics

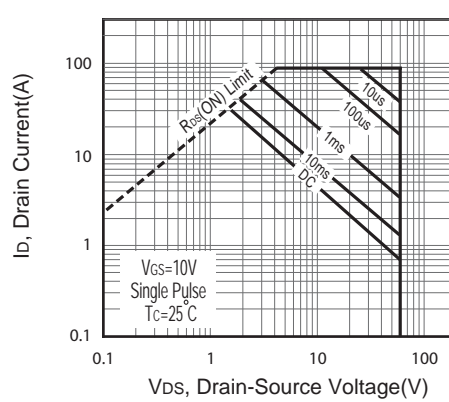
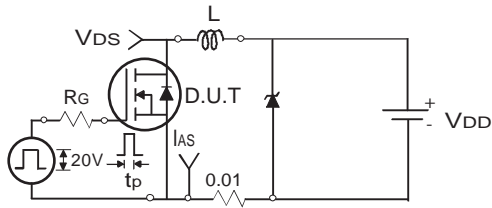

Figure 12. Maximum Safe Operating Area

Jun,05,2013

STU664S STD664S

Ver 1.0



Uncamped Inductive Test Circuit

Figure 13a.

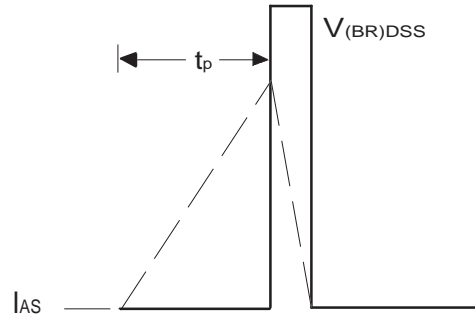

Unclamped Inductive Waveforms

Figure 13b.

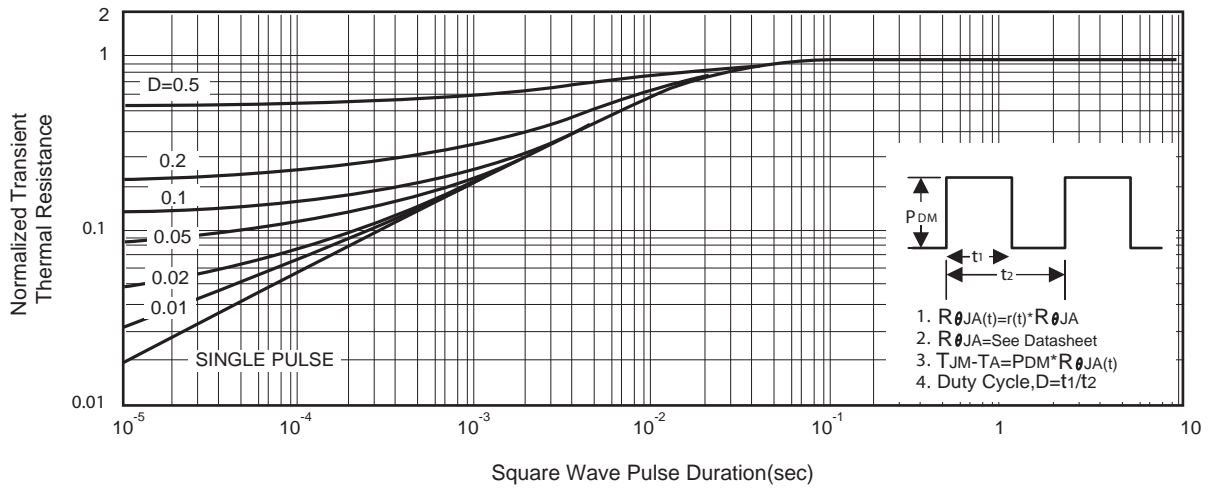

Figure 14. Normalized Thermal Transient Impedance Curve

Jun,05,2013

STU664S STD664S

Ver 1.0

PACKAGE OUTLINE DIMENSIONS

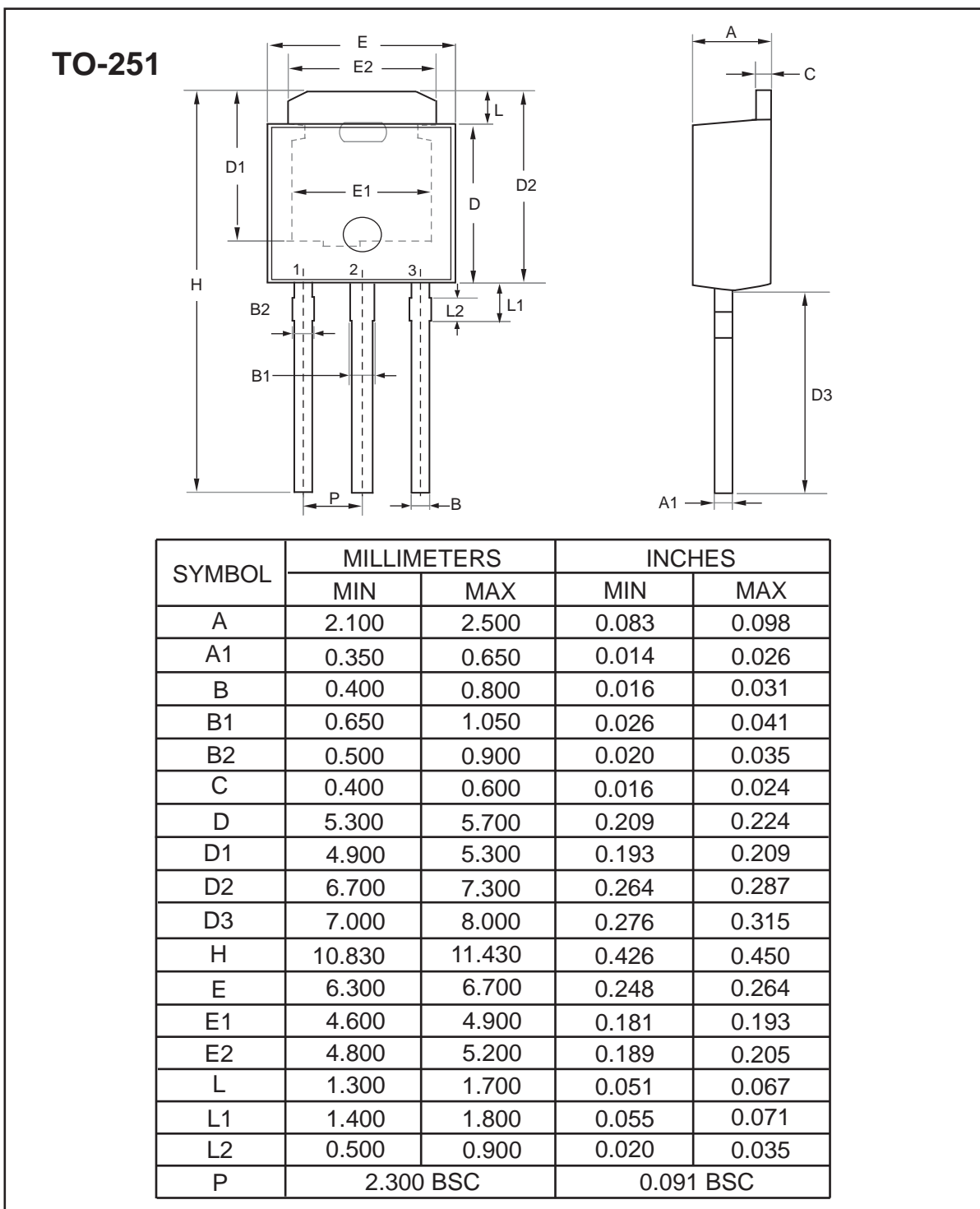

Jun,05,2013

STU664S STD664S

Ver 1.0

TO-252

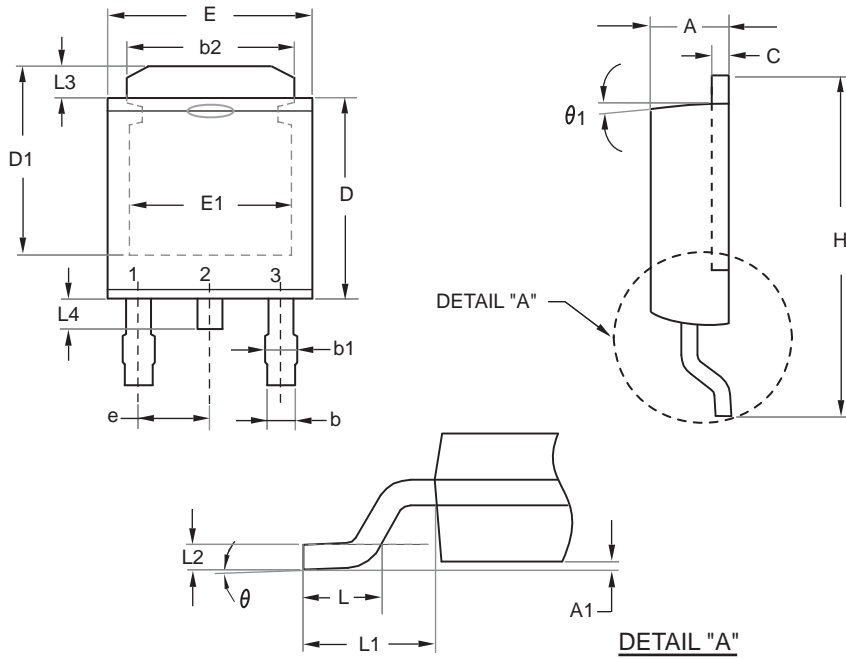

SYMBOLS	MILLIMETERS		INCHES	
	MIN	MAX	MIN	MAX
A	2.100	2.500	0.083	0.098
A1	0.000	0.200	0.000	0.008
b	0.400	0.889	0.016	0.035
b1	0.770	1.140	0.030	0.045
b2	4.800	5.460	0.189	0.215
C	0.400	0.600	0.016	0.024
D	5.300	6.223	0.209	0.245
D1	4.900	5.515	0.193	0.217
E	6.300	6.731	0.248	0.265
E1	4.400	5.004	0.173	0.197
e	2.290 REF		0.090 BSC	
H	8.900	10.400	0.350	0.409
L	1.397	1.770	0.055	0.070
L1	2.743 REF.		0.108 REF.	
L2	0.508 REF.		0.020 REF.	
L3	0.890	1.700	0.035	0.067
L4	0.500	1.100	0.020	0.043
theta	0°	10°	0°	10°
theta1	7° REF.		7° REF.	

Jun,05,2013

STU664S STD664S

Ver 1.0

TO-251 Tube/TO-252 Tape and Reel Data

TO-251 Tube

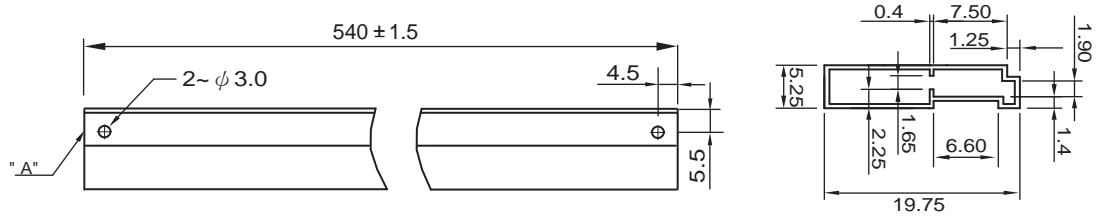

TO-252 Carrier Tape

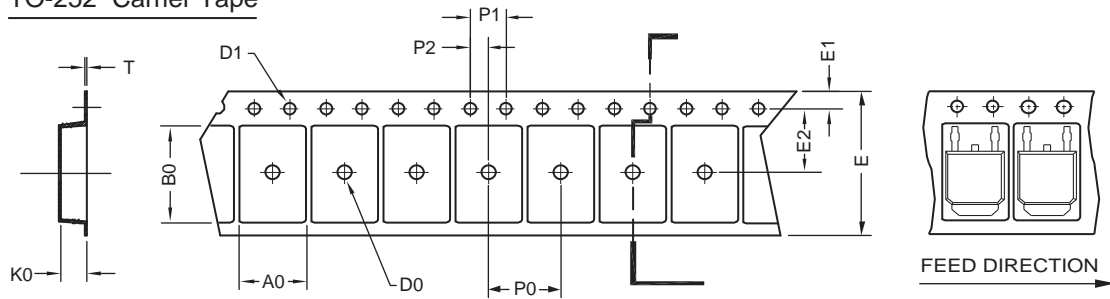

UNIT:mm

PACKAGE	A0	B0	K0	D0	D1	E	E1	E2	P0	P1	P2	T
TO-252 (16 mm)	6.96 ±0.1	10.49 ±0.1	2.79 ±0.1	φ 2	φ 1.5 +0.1 - 0	16.0 ±0.3	1.75 ±0.1	7.5 ±0.15	8.0 ±0.1	4.0 ±0.1	2.0 ±0.15	0.3 ±0.05

TO-252 Reel

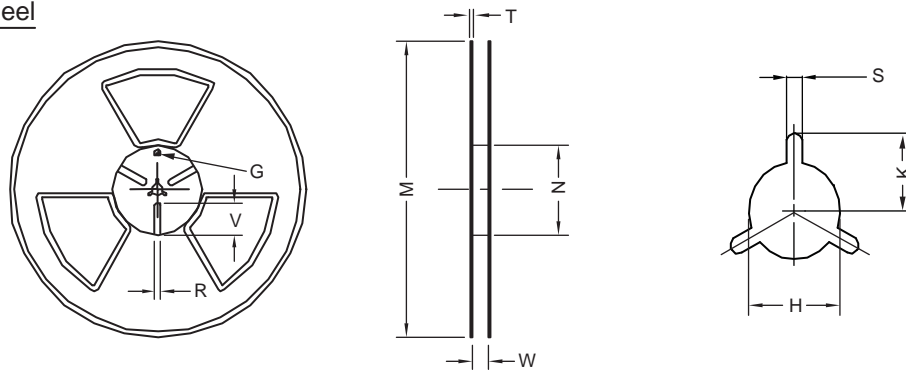

UNIT:mm

TAPE SIZE	REEL SIZE	M	N	W	T	H	K	S	G	R	V
16 mm	φ 330	φ 330 ± 0.5	φ 97 ± 1.0	17.0 + 1.5 - 0	2.2	φ 13.0 + 0.5 - 0.2	10.6	2.0 ±0.5	---	---	---

Jun,05,2013