



# IMB30-20NNPVC0S

IMB

**INDUCTIVE PROXIMITY SENSORS**

**SICK**  
Sensor Intelligence.



Illustration may differ



## Ordering information

| Type            | Part no. |
|-----------------|----------|
| IMB30-20NNPVC0S | 1074409  |

Other models and accessories → [www.sick.com/IMB](http://www.sick.com/IMB)

## Detailed technical data

### Features

|   |   |
|---|---|
| <b>Housing</b>                          | Cylindrical thread design                 |
| <b>Housing</b>                          | Standard                                  |
| <b>Thread size</b>                      | M30<br>1.5                                |
| <b>Diameter</b>                         | Ø 30 mm                                   |
| <b>Sensing range S<sub>n</sub></b>      | 20 mm                                     |
| <b>Safe sensing range S<sub>a</sub></b> | 16.2 mm                                   |
| <b>Installation type</b>                | Non-flush                                 |
| <b>Switching frequency</b>              | 500 Hz                                    |
| <b>Connection type</b>                  | Male connector M12, 4-pin <sup>1)</sup>   |
| <b>Switching output</b>                 | NPN                                       |
| <b>Output function</b>                  | Complementary                             |
| <b>Electrical wiring</b>                | DC 4-wire                                 |
| <b>Enclosure rating</b>                 | IP68 <sup>2)</sup><br>IP69K <sup>3)</sup> |
| <b>Special features</b>                 | Resistant against coolant lubricants      |

<sup>1)</sup> With gold plated contact pins.

<sup>2)</sup> According to EN 60529.

<sup>3)</sup> According to ISO 20653:2013-03.

### Mechanics/electronics

|                       |                     |
|-----------------------|---------------------|
| <b>Supply voltage</b> | 10 V DC ... 30 V DC |
| <b>Ripple</b>         | ≤ 10 %              |
| <b>Voltage drop</b>   | ≤ 2 V <sup>1)</sup> |

<sup>1)</sup> At I<sub>a</sub> max.

<sup>2)</sup> Without load.

<sup>3)</sup> U<sub>b</sub> and T<sub>a</sub> constant.

<sup>4)</sup> Of S<sub>r</sub>.

<sup>5)</sup> Valid if toothed side of nut is used.

<sup>6)</sup> Reference voltage DC 50 V.

|   |  |
|---|--|
| <b>Current consumption</b>                  | ≤ 10 mA <sup>2)</sup>  |
| <b>Hysteresis</b>                           | 3 % ... 20 %   |
| <b>Reproducibility</b>                      | ≤ 2 % <sup>3) 4)</sup>   |
| <b>Temperature drift (of S<sub>r</sub>)</b> | ± 10 %   |
| <b>EMC</b>                                  | According to EN 60947-5-2  |
| <b>Continuous current I<sub>a</sub></b>     | ≤ 200 mA   |
| <b>Short-circuit protection</b>             | ✓  |
| <b>Reverse polarity protection</b>          | ✓  |
| <b>Power-up pulse protection</b>            | ✓  |
| <b>Power-up pulse</b>                       | ≤ 5 ms   |
| <b>Shock and vibration resistance</b>       | 100 g / 2 ms / 500 cycles; 150 g / 1 Mio cycles; 10 Hz ... 55 Hz / 1 mm; 55 Hz ... 500 Hz / 60 g |
| <b>Ambient operating temperature</b>        | -40 °C ... +100 °C   |
| <b>Housing material</b>                     | Stainless steel, V2A (1.4305)  |
| <b>Sensing face material</b>                | Plastic, LCP   |
| <b>Housing length</b>                       | 70 mm  |
| <b>Thread length</b>                        | 40 mm  |
| <b>Tightening torque, max.</b>              | Typ. 100 Nm <sup>5)</sup>  |
| <b>Protection class</b>                     | II <sup>6)</sup>   |
| <b>UL File No.</b>                          | E181493  |

1) At I<sub>a</sub> max.

2) Without load.

3) U<sub>b</sub> and T<sub>a</sub> constant.

4) Of S<sub>r</sub>.

5) Valid if toothed side of nut is used.

6) Reference voltage DC 50 V.

### Reduction factors

|                                   |  |
|-----------------------------------|--|
| <b>Note</b>                       | The values are reference values which may vary |
| <b>Stainless steel (V2A, 304)</b> | Approx. 0.78                                   |
| <b>Aluminum (Al)</b>              | Approx. 0.44                                   |
| <b>Copper (Cu)</b>                | Approx. 0.36                                   |
| <b>Brass (Br)</b>                 | Approx. 0.46                                   |

### Installation note

|               |                                       |
|---------------|---------------------------------------|
| <b>Remark</b> | Associated graphic see "Installation" |
| <b>A</b>      | 20 mm                                 |
| <b>B</b>      | 62 mm                                 |
| <b>C</b>      | 30 mm                                 |
| <b>D</b>      | 60 mm                                 |
| <b>E</b>      | 20 mm                                 |
| <b>F</b>      | 160 mm                                |

### Classifications

|                   |          |
|-------------------|----------|
| <b>ECI@ss 5.0</b> | 27270101 |
|-------------------|----------|

|                       |          |
|-----------------------|----------|
| <b>ECl@ss 5.1.4</b>   | 27270101 |
| <b>ECl@ss 6.0</b>     | 27270101 |
| <b>ECl@ss 6.2</b>     | 27270101 |
| <b>ECl@ss 7.0</b>     | 27270101 |
| <b>ECl@ss 8.0</b>     | 27270101 |
| <b>ECl@ss 8.1</b>     | 27270101 |
| <b>ECl@ss 9.0</b>     | 27270101 |
| <b>ETIM 5.0</b>       | EC002714 |
| <b>ETIM 6.0</b>       | EC002714 |
| <b>UNSPSC 16.0901</b> | 39122230 |

Installation note

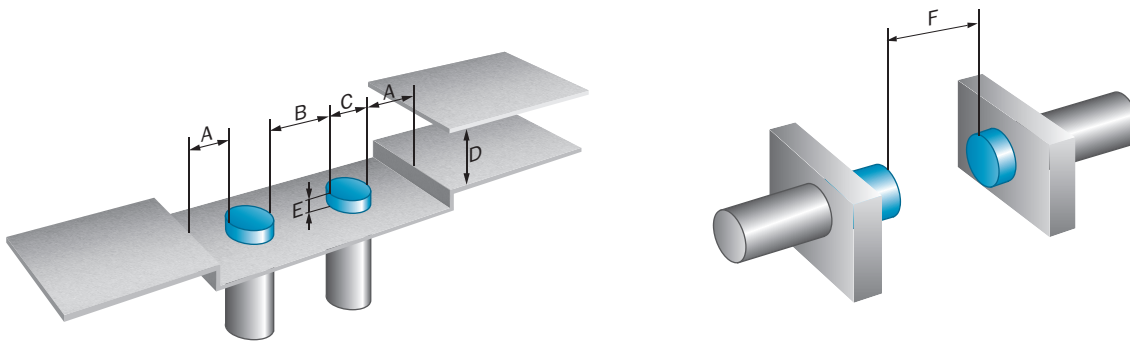

Connection diagram

cd-006

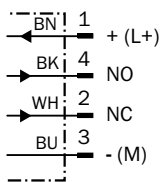

### Characteristic curve

Non-flush installation

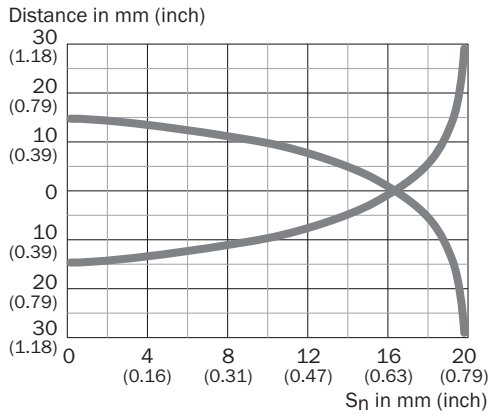

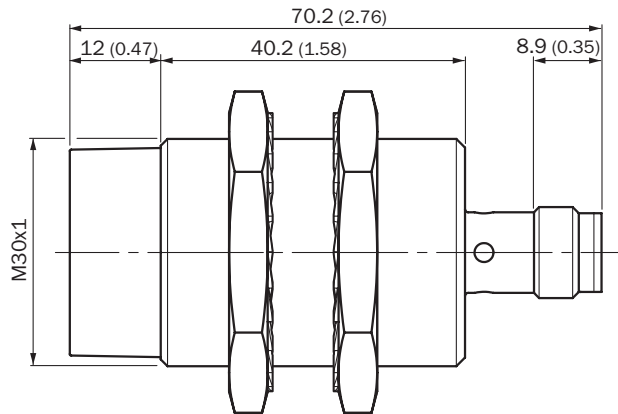

### Dimensional drawing (Dimensions in mm (inch))

IMB30 Standard, connector M12, non-flush





### Recommended accessories

Other models and accessories → [www.sick.com/IMB](http://www.sick.com/IMB)

|   | Brief description  | Type         | Part no. |
|---|--|--------------|----------|
| <b>Universal bar clamp systems</b>  |  |              |          |
|  | Plate N11N for universal clamp bracket, Stainless steel 1.4571 (sheet), Stainless steel 1.4408 (clamp), Universal clamp (5322626), mounting hardware | BEF-KHS-N11N | 2071081  |
| <b>Mounting brackets and plates</b>   |  |              |          |
|  | Mounting plate for M30 sensors, steel, zinc coated, without mounting hardware  | BEF-WG-M30   | 5321871  |

|   | <b>Brief description</b>   | <b>Type</b>        | <b>Part no.</b> |
|---|--|--------------------|-----------------|
|    | Mounting bracket for M30 sensors, steel, zinc coated, without mounting hardware  | BEF-WN-M30         | 5308445         |
| <b>Plug connectors and cables</b>   |  |                    |                 |
|    | Head A: female connector, M12, 4-pin, straight<br>Head B: Flying leads<br>Cable: PP, unshielded, 2 m<br>This product is generally resistant to chemical cleaning agents (see ECOLAB) and other chemical compounds such as H2O2 and CH2O2. Before permanent installation is carried out, the material's resistance to the cleaning agent being used must be checked., Resistant against lactic acid & hydrogen peroxide (H2O2)        | DOL-1204-G02MRN    | 6058291         |
|   | Head A: female connector, M12, 4-pin, straight<br>Head B: Flying leads<br>Cable: PP, unshielded, 5 m<br>This product is generally resistant to chemical cleaning agents (see ECOLAB) and other chemical compounds such as H2O2 and CH2O2. Before permanent installation is carried out, the material's resistance to the cleaning agent being used must be checked., Resistant against lactic acid & hydrogen peroxide (H2O2)        | DOL-1204-G05MRN    | 6058476         |
|    | Head A: female connector, M12, 4-pin, angled with LED<br>Head B: Flying leads<br>Cable: PP, unshielded, 2 m<br>This product is generally resistant to chemical cleaning agents (see ECOLAB) and other chemical compounds such as H2O2 and CH2O2. Before permanent installation is carried out, the material's resistance to the cleaning agent being used must be checked., Resistant against lactic acid & hydrogen peroxide (H2O2) | DOL-1204-L02MRN    | 6058482         |
|   | Head A: female connector, M12, 4-pin, angled with LED<br>Head B: Flying leads<br>Cable: PP, unshielded, 5 m<br>This product is generally resistant to chemical cleaning agents (see ECOLAB) and other chemical compounds such as H2O2 and CH2O2. Before permanent installation is carried out, the material's resistance to the cleaning agent being used must be checked., Resistant against lactic acid & hydrogen peroxide (H2O2) | DOL-1204-L05MRN    | 6058483         |
|  | Head A: female connector, M12, 4-pin, angled<br>Head B: Flying leads<br>Cable: PP, unshielded, 2 m<br>This product is generally resistant to chemical cleaning agents (see ECOLAB) and other chemical compounds such as H2O2 and CH2O2. Before permanent installation is carried out, the material's resistance to the cleaning agent being used must be checked., Resistant against lactic acid & hydrogen peroxide (H2O2)          | DOL-1204-W02MRN    | 6058474         |
|   | Head A: female connector, M12, 4-pin, angled<br>Head B: Flying leads<br>Cable: PP, unshielded, 5 m<br>This product is generally resistant to chemical cleaning agents (see ECOLAB) and other chemical compounds such as H2O2 and CH2O2. Before permanent installation is carried out, the material's resistance to the cleaning agent being used must be checked., Resistant against lactic acid & hydrogen peroxide (H2O2)          | DOL-1204-W05MRN    | 6058477         |
|  | Head A: female connector, M12, 4-pin, straight, A-coded<br>Head B: Flying leads<br>Cable: Sensor/actuator cable, PUR, halogen-free, unshielded, 2 m  | YF2A14-020UB3XLEAX | 2095607         |
|   | Head A: female connector, M12, 4-pin, straight, A-coded<br>Head B: Flying leads<br>Cable: Sensor/actuator cable, PUR, halogen-free, unshielded, 5 m  | YF2A14-050UB3XLEAX | 2095608         |
|  | Head A: female connector, M12, 4-pin, angled, A-coded<br>Head B: Flying leads<br>Cable: Sensor/actuator cable, PUR, halogen-free, unshielded, 5 m  | YG2A14-050UB3XLEAX | 2095767         |

|  | <b>Brief description</b>  | <b>Type</b>        | <b>Part no.</b> |
|--|---|--------------------|-----------------|
|   | Head A: male connector, M12, 4-pin, straight, A-coded<br>Head B: Flying leads<br>Cable: Sensor/actuator cable, PUR, halogen-free, unshielded, 2 m   | YM2A14-020UB3XLEAX | 2095867         |
|  | Head A: male connector, M12, 4-pin, straight, A-coded<br>Head B: Flying leads<br>Cable: Sensor/actuator cable, PUR, halogen-free, unshielded, 5 m   | YM2A14-050UB3XLEAX | 2095858         |
| <br><br><br> | Head A: male connector, M12, 4-pin, angled, A-coded<br>Head B: Flying leads<br>Cable: Sensor/actuator cable, PUR, halogen-free, unshielded, 5 m   | YN2A14-050UB3XLEAX | 2096628         |
|  | Head A: female connector, M12, 4-pin, angled<br>Head B: male connector, M12, 4-pin, straight<br>Cable: PP, unshielded, 2 m<br>This product is generally resistant to chemical cleaning agents (see ECOLAB) and other chemical compounds such as H2O2 and CH2O2. Before permanent installation is carried out, the material's resistance to the cleaning agent being used must be checked., Resistant against lactic acid & hydrogen peroxide (H2O2)   | DSL-1204-B02MRN    | 6058502         |
|  | Head A: female connector, M12, 4-pin, angled<br>Head B: male connector, M12, 4-pin, straight<br>Cable: PP, unshielded, 5 m<br>This product is generally resistant to chemical cleaning agents (see ECOLAB) and other chemical compounds such as H2O2 and CH2O2. Before permanent installation is carried out, the material's resistance to the cleaning agent being used must be checked., Resistant against lactic acid & hydrogen peroxide (H2O2)   | DSL-1204-B05MRN    | 6058503         |
|  | Head A: female connector, M12, 4-pin, straight<br>Head B: male connector, M12, 4-pin, straight<br>Cable: PP, unshielded, 2 m<br>This product is generally resistant to chemical cleaning agents (see ECOLAB) and other chemical compounds such as H2O2 and CH2O2. Before permanent installation is carried out, the material's resistance to the cleaning agent being used must be checked., Resistant against lactic acid & hydrogen peroxide (H2O2) | DSL-1204-G02MRN    | 6058499         |
|  | Head A: female connector, M12, 4-pin, straight<br>Head B: male connector, M12, 4-pin, straight<br>Cable: PP, unshielded, 5 m<br>This product is generally resistant to chemical cleaning agents (see ECOLAB) and other chemical compounds such as H2O2 and CH2O2. Before permanent installation is carried out, the material's resistance to the cleaning agent being used must be checked., Resistant against lactic acid & hydrogen peroxide (H2O2) | DSL-1204-G05MRN    | 6058500         |
|   | Head A: female connector, M12, 4-pin, straight, A-coded<br>Head B: male connector, M12, 4-pin, straight, A-coded<br>Cable: Sensor/actuator cable, PUR, halogen-free, unshielded, 5 m  | YF2A14-050UB3M2A14 | 2096001         |

## SICK AT A GLANCE

SICK is one of the leading manufacturers of intelligent sensors and sensor solutions for industrial applications. A unique range of products and services creates the perfect basis for controlling processes securely and efficiently, protecting individuals from accidents and preventing damage to the environment.

We have extensive experience in a wide range of industries and understand their processes and requirements. With intelligent sensors, we can deliver exactly what our customers need. In application centers in Europe, Asia and North America, system solutions are tested and optimized in accordance with customer specifications. All this makes us a reliable supplier and development partner.

Comprehensive services complete our offering: SICK LifeTime Services provide support throughout the machine life cycle and ensure safety and productivity.

For us, that is “Sensor Intelligence.”

## WORLDWIDE PRESENCE:

Contacts and other locations [www.sick.com](http://www.sick.com)