

# PV0 SERIES ANTI-VANDAL SWITCH

ANTI-VANDAL SWITCHES  
DETECTOR SWITCHES  
DIP SWITCHES  
KEYLOCK SWITCHES  
NAVIGATION SWITCHES  
PUSHBUTTON SWITCHES  
ROCKER SWITCHES  
ROTARY SWITCHES  
SLIDE SWITCHES  
SNAP ACTION SWITCHES  
TACTILE SWITCHES  
TOGGLE SWITCHES  
CAP OPTIONS

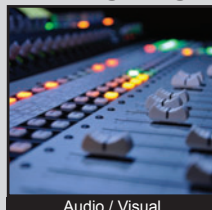

## APPLICATIONS / MARKETS



Audio / Visual



Security Devices

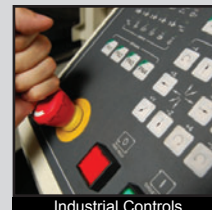

Industrial Controls

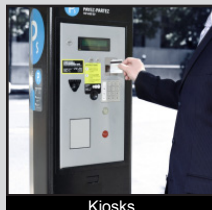

Kiosks



Electrical Housewares

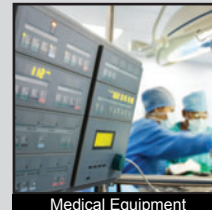

Medical Equipment

# RoHS

## SPECIFICATIONS

**Electrical Rating:** 2A, 48VDC  
**Mechanical Life:** 1,000,000 Cycles  
**Electrical Life:** 50,000 Cycles  
**Contact Resistance:** 50mΩ Max.  
**Insulation Resistance:** 1000 MΩ Min.  
**Dielectric Strength:** 2,000VAC  
**Operating/Storage Temperature:** -20°C to 55°C  
**Travel:** 1.50mm  
**Moisture Protection:** IP65  
**Contact Arrangement:** SPST Off-(On)  
**Actuation Force:** 4 N  
**Panel Thickness:** 1-6mm  
**Mounting Nut Torque:** 5-14Nm

## FEATURES & BENEFITS

- 12.2mm panel cutout
- Ring or dot illumination options
- Multiple LED color options
- IP65 rated

## PART NUMBER CONFIGURATOR

Series	Actuator Options	Terminal Options	Function Options	Rating Options	Body Finish Options	Actuator Finish Options	Contact Material Options	Lens Style Options	LED-Color Options	Illumination Voltage Options
<input type="text" value="PV0"/>	<input type="text" value="H - High"/>	<input type="text" value="2 - Solder"/>	<input type="text" value="4 - Off - (On)*"/>	<input type="text" value="0 - 2A, 48VDC"/>	<input type="text" value="S - Stainless Steel"/>	<input type="text" value="S - Stainless Steel"/>	<input type="text" value="NONE - Silver"/>	<input type="text" value="NONE - Non-Illuminated"/>	<input type="text" value="NONE - Non-Illuminated"/>	<input type="text" value="NONE - Non-Illuminated"/>
					<input type="text" value="1 - Black Anodized"/>	<input type="text" value="1 - Black Anodized"/>	<input type="text" value="G - Gold"/>	<input type="text" value="2 - Dot Illumination"/>	<input type="text" value="0 - White"/>	<input type="text" value="1 - Base Voltage†"/>
								<input type="text" value="3 - Ring Illumination"/>	<input type="text" value="1 - Red"/>	
								<input type="text" value="4 - Blue"/>	<input type="text" value="2 - Orange"/>	
								<input type="text" value="5 - Yellow"/>	<input type="text" value="3 - Green"/>	
									<input type="text" value="4 - Blue"/>	
									<input type="text" value="5 - Yellow"/>	

### NOTES:

\* (ON) Denotes function is momentary

† Base voltage on LEDs:

1.8V @ 20mA for Red, Yellow and Orange LED colors

2.8V @ 20mA for Blue, Green and White LED colors

Specifications subject to change without notice



**E-SWITCH®**

www.e-switch.com

800.867.2717

2

# PV0 SERIES ANTI-VANDAL SWITCH

## RING ILLUMINATION

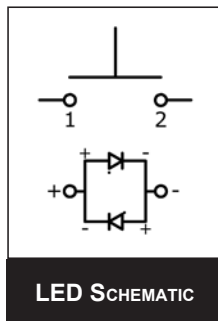
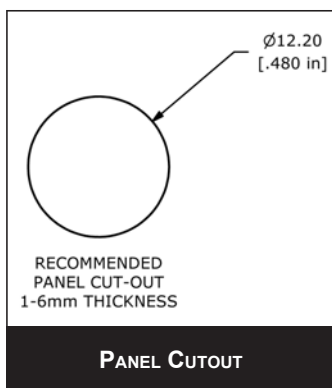
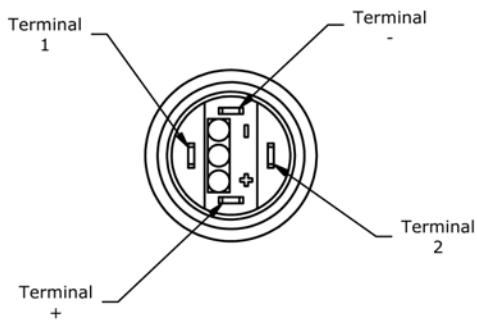
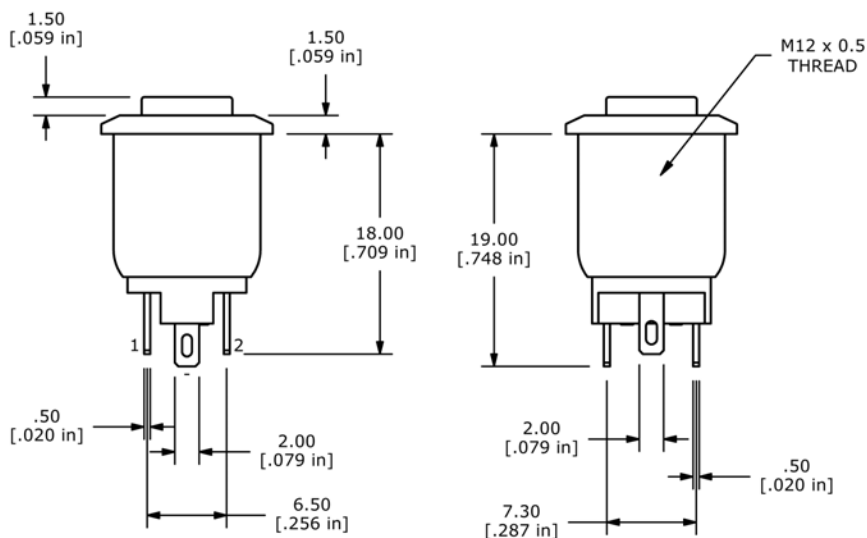
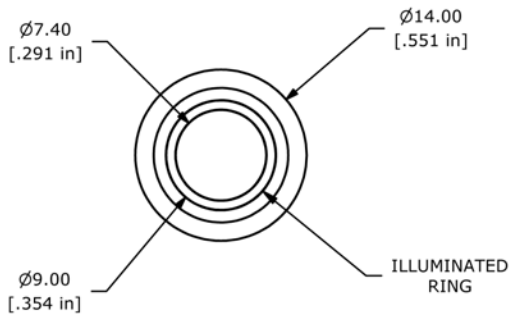

# PV0 SERIES ANTI-VANDAL SWITCH

## DOT ILLUMINATION

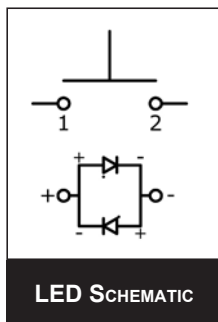
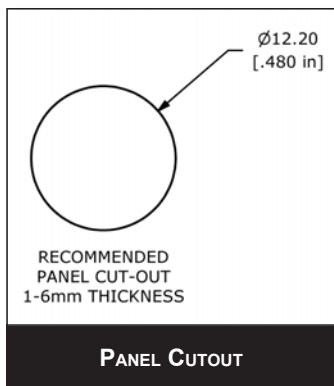
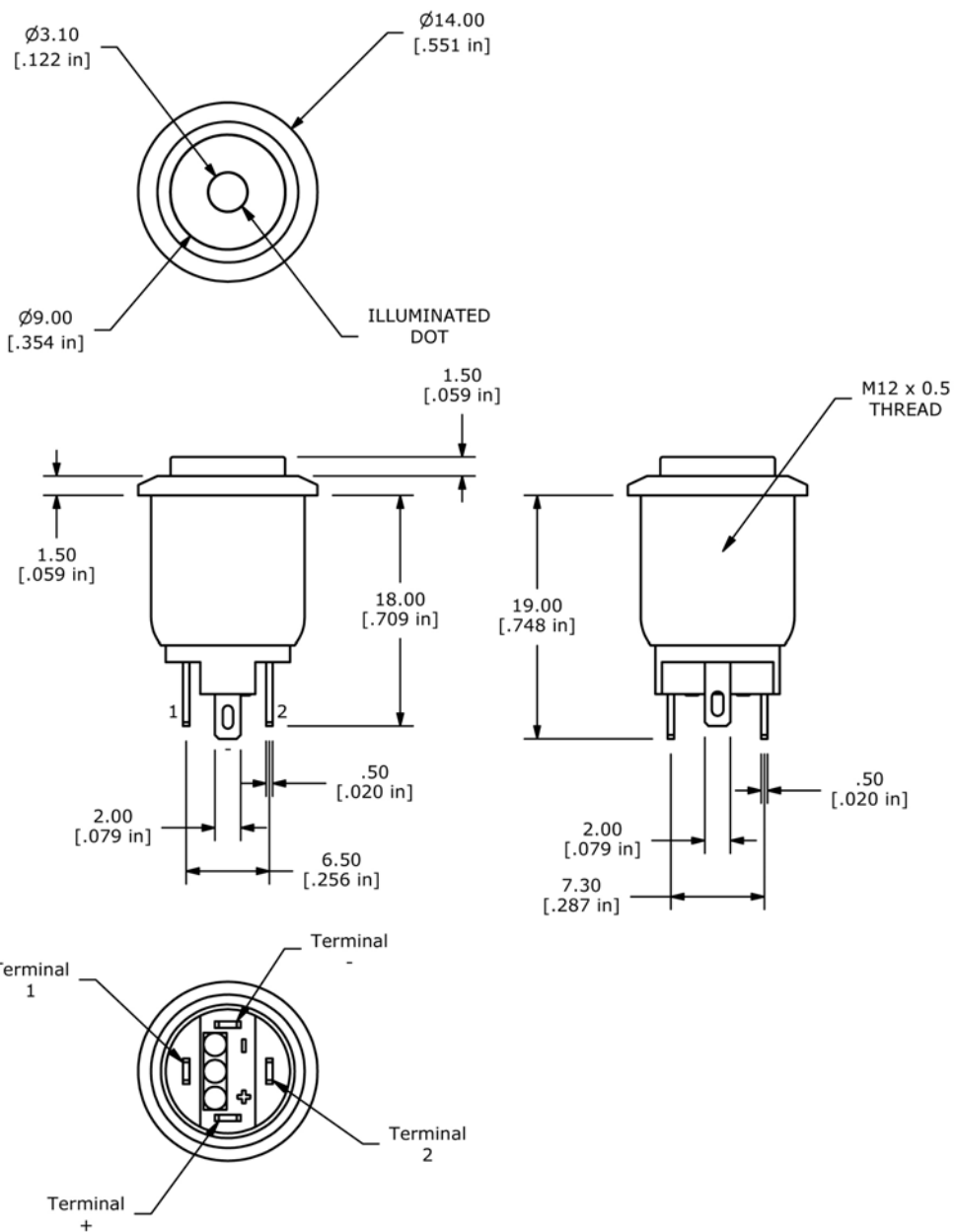

# PV0 SERIES ANTI-VANDAL SWITCH

NON-ILLUMINATED

