

PLEASE CHECK WWW.MOLEX.COM FOR LATEST PART INFORMATION

Part Number: [0740266420](#)

Status: **Active**

Overview: [VHDM Backplane Connector Systems](#)

Description: VHDM Board-to-Board Daughtercard Receptacle, 2.00mm Pitch, Right-Angle, 6 Rows, 2 Blade Power Module, 1 Circuit, Mating Blade Length: 12.00mm Blade 1, 9.00mm Blade 2

Documents:

[3D Model](#)

[Drawing \(PDF\)](#)

[Packaging Specification PK-70873-200 \(PDF\)](#)

[RoHS Certificate of Compliance \(PDF\)](#)

General

Product Family	Backplane Connectors
Series	74026
Application	Daughtercard
Application Tooling Documents	TM-622010999
Comments	Daughtercard Receptacle Module, Power, 2-Blade
Component Type	Power Receptacle
Overview	VHDM Backplane Connector Systems
Product Name	VHDM
UPC	800755848663

Physical

Circuits (Loaded)	1
Circuits (maximum)	2
Color - Resin	Black
Durability (mating cycles max)	200
First Mate / Last Break	No
Guide to Mating Part	No
Keying to Mating Part	None
Material - Metal	High Performance Alloy (HPA)
Material - Plating Mating	Gold
Material - Plating Termination	Tin-Lead
Material - Resin	High Temperature Thermoplastic
Net Weight	2.155/g
Number of Columns	N/A
Number of Pairs	Open Pin Field
Number of Rows	6
Orientation	Right Angle
PC Tail Length	2.80mm
PCB Locator	No
PCB Retention	None
PCB Thickness - Recommended	1.80mm
Packaging Type	Tube
Pitch - Mating Interface	2.00mm
Plating min - Mating	0.762µm
Plating min - Termination	0.889µm
Polarized to PCB	Yes
Surface Mount Compatible (SMC)	Yes
Temperature Range - Operating	-55° to +105°C
Termination Interface: Style	Through Hole - Compliant Pin

Electrical

Current - Maximum per Contact	10.0A
Data Rate	2.5 Gbps
Real Signals (per 25mm)	72
Voltage - Maximum	250V

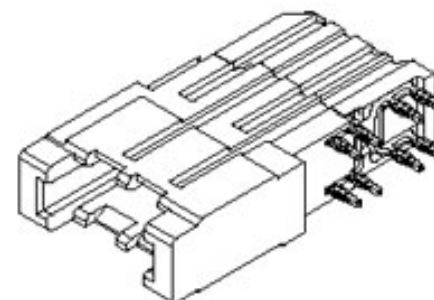

Series image - Reference only

EU ELV

Not Relevant

EU RoHS

Compliant

REACH SVHC

Not Contained Per - ED/61/2018 (27 June 2018)

Halogen-Free

Status

Low-Halogen

For more information, please visit [Contact US](#)

China ROHS

ELV

RoHS Phthalates

China RoHS

Green Image

Not Relevant

Not Contained

Search Parts in this Series

[74026](#) Series

Mates With

[74029](#) VHDM Board-to-Board Backplane Receptacle Power Module

Solder Process Data

Lead-free Process Capability

N/A

Material Info**Reference - Drawing Numbers**

Packaging Specification

PK-70873-200

Sales Drawing

SD-74026-001

This document was generated on 10/08/2018

PLEASE CHECK WWW.MOLEX.COM FOR LATEST PART INFORMATION