



DESCRIPTION :

15~15.6W AC-DC DIN RAIL Power Supply

The rated output power of TPR/DG-15-XS series is 15~15.6W, input voltage range : 90-264VAC, output voltage : 12V, 24V. High reliability, precision, efficiency, ultra-small size, stable output voltage and etc, with short circuit & overload protection, Widely used in telecommunications, industrial control, instrument, data acquisition, signal control, New Energy, Security, and other electronic systems.

FEATURES

AC input : 90VAC-264VAC, DC input: 127-370VDC	Built-in DC OK relay contact	Operating temperature : -25°C~70°C
Mounting track: TS-35/7.5 or TS-35/15	Protection: short circuit, over-load, over-voltage, over-temperature	Mini width: 32mm
RoHS complaint	High reliability, efficiency, 100% full load burn-in test	Built-in current limiting circuit

SELECTION GUIDE

Part Number	Input Voltage			Output				Efficiency @25°C, (Typ) %
	(VAC)		(VDC)	Voltage (VDC)	Pre-set voltage @25°C (V)	Rated current (A)	Rated power (W)	
	Rated	Range	Rated					
TPR/DG-15-12S	220	90-264	127-370	12	12.00-12.20	1.25	15	83
TPR/DG-15-24S	220	90-264	127-370	24	24.00-24.20	0.65	15.6	84.5

All specifications typical at TA=25°C, nominal input voltage and rated output current unless otherwise specified.

OUTPUT CHARACTERISTICS

Conditions	Conditions	Parameter
Output voltage regulation	12V output voltage	12-14V
	24V output voltage	24-28V
Rated Output current	12V output voltage	1.25A at 12V
		1.08A at 14V
	24V output voltage	0.65A at 24V
		0.55A at 28V
Rated Output power	12V output voltage	15W/12V 15.12W/14V
	24V output voltage	15.6W/24V, 15.4W/28V
Ripple&Noise 10<Ta≤70°C	12V 24V output voltage	≤120mVp-p
Ripple&Noise -25<Ta≤10°C	12V 24V output voltage	≤240mVp-p
Capacitive load capacity	output voltage	3000uF @12V 1500uF@24V
Voltage regulation accuracy @-25~70°C		± 1.0%
Line regulation @-25~70°C		± 0.5%
Load regulation @-25~70°C		± 1.0%
Temp. coefficient @-25~70°C		± 0.03%/°C
Set-up time @25°C	≤1500mS@230Vac input	
Hold-up time @25°C	≥20mS@(230Vac input, Rated load)	
Overshoot&Undershoot	<5.0%	

INPUT CHARACTERISTICS

Conditions	Parameter
Input voltage range	90VAC~264 VAC
input voltage range	127VDC-370VDC
Frequency Range	47Hz~63Hz
Set-up voltage @-25~70°C	<90 VAC <127VDC
Input current @25°C	<0.5 A/ AC input ; 0.2A/127VDC 0.1A/300VDC
Inrush current @25°C	50A@230 Vac input

PROTECTION

Conditions	Parameter	Notes
Over-Load (12Voutput)	1.5~2A	Limit output current , hiccup mode, auto recovery
Over-Load (24Voutput)	0.7~1A	
Over-voltage (12Voutput)	15~16.8V	Constant voltage, auto recovery
Over-voltage (24Voutput)	28.8~31.2V	
Output short circuit protection	Long-term model , auto recovery	

ENVIRONMENT CHARACTERISTICS

Conditions	Parameter
Operating amb. Temp.&Humi. (12V 24V output)	-25℃~70℃; 20%~90%RH No condensing 60℃~70℃
Storage Temp. & Humi.	-40℃~85℃; 5%~95%RH No condensing
Vibration	10 ~ 500Hz, 2G, 10min./1cycle, each along X,Y, Z axes IEC 60068-2-6
Pulse	20G/11mS pulse ,3 times at each X,Y,Z axes IEC 60068-2-27
Altitude	2000m

SAFETY&EMC STANDARDS @25℃

Conditions	Parameter
Safety Standards	GB4943 ,EN60950, UL60950, (for reference)
Withstand Voltage	I/P-O/P:3.0KVac/10mA; I/P-PE:1.5KVac/10mA; O/P-PE:0.5KVdc/10mA Test time:1min.
Isolation resistance	I/P-O/P: 10M ohms; I/P-PE: 10M ohms; O/P-PE : 10M ohms
Grounding test	Test condition: 32A / 2min.; Grounding resistance: <0.1 ohms
Leakage Current @ 25℃	I/P-Grounding≤3.5mA; I/P-O/P ≤0.25mA (264Vac input, 63Hz)
EMC emission	Compliance to EN55022, EN55024, FCC PART 15 CLASS B
EMC immunity	Compliance to EN61000-4-2,3,4,5,6,11 heavy industry level
Harmonic current	EN61000-3-2, CLASS A

OTHERS

Conditions	Parameter
Net Weight	0.16kg
Dimension (L*W*H)	103.7*32*97.5mm
Cooling method	Cooling by free air flow
Series / parallel function	yes
Output indicator	Green light

RELIABILITY CHARACTERISTICS

Conditions	Parameter
MTBF	590, 000Hrs AT 25℃, Telcordia SR332
Design electrolytic capacitor life-time	>3years AT 50℃ 230VAC input @12V1.25A output @24V0.65A output

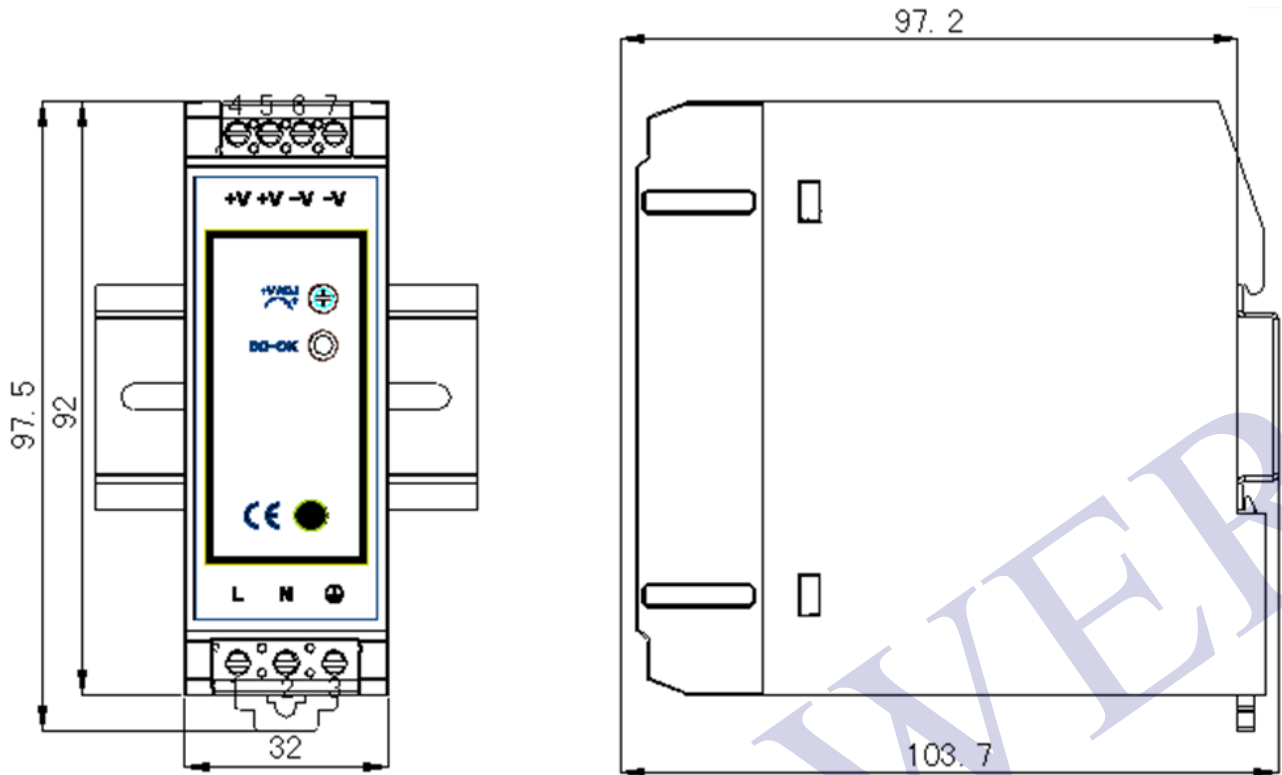

1.AC Screw terminal information			
No.	Function	Wire Specs	Recommended torque
1	L	26-12AWG	0.5Nm
2	N		
3	PE		

2.DC Screw terminal information			
No.	Function	Wire Specs	Recommended torque
4	V+	26-12AWG	0.5Nm
5			
6	V-		
7			

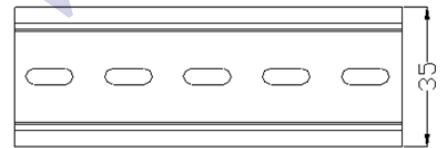

Mounting way: TS35/7.5 or TS35/15

	AC Terminal	DC Terminal
Type	Screw terminal blocks	
Solid Wire	0.32-2.5mm ²	0.65-2.5mm ²
Strand Wire	0.32-2.5mm ²	0.65-2.5mm ²
Wire Spec	AWG26-12	
Max Wire Diameter	2.05mm	
Recommended stripping length	6-7mm	
Screwdriver	3.5mm Straight Screwdriver	
Recommended Torque	0.5NM	

12V

Load-Ambient derating curve

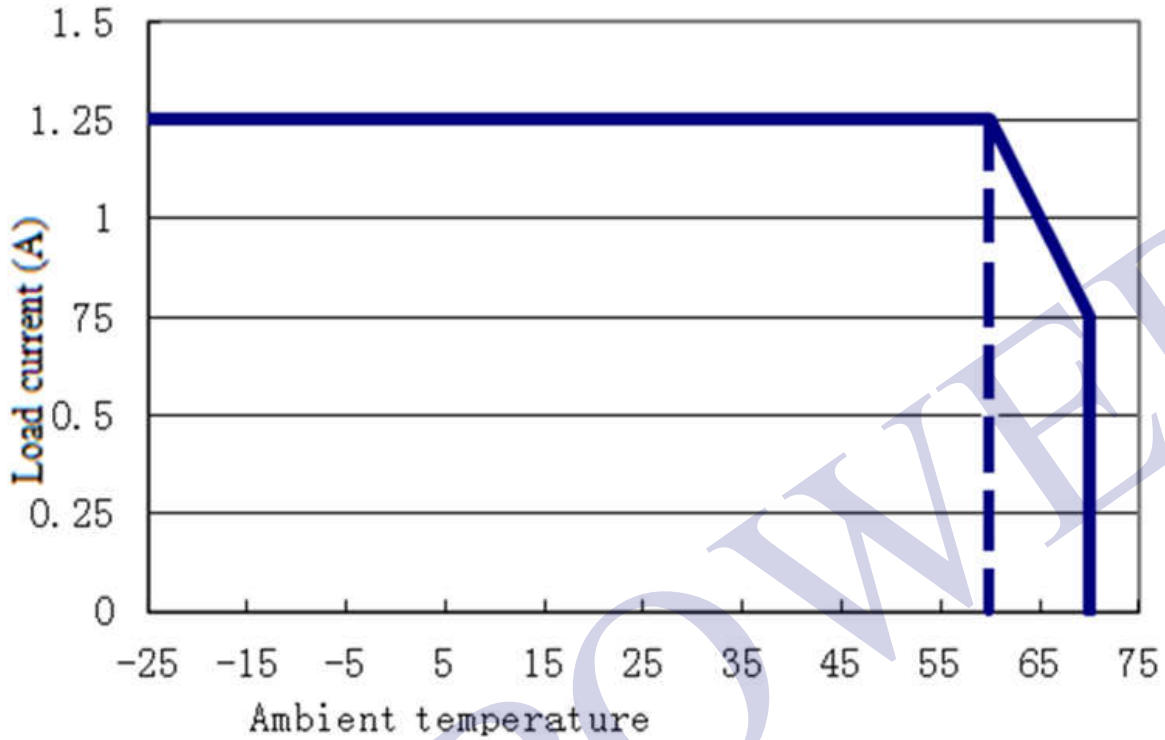

24V

Load-Ambient derating curve

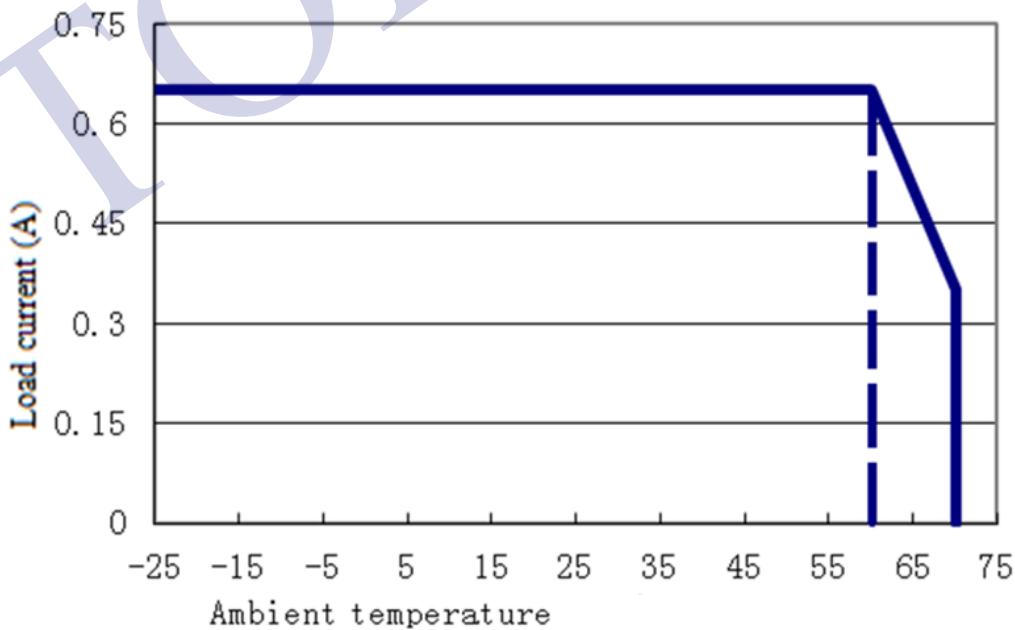

MOUNTING METHOD INSTRUCTION

A1 is recommended output current , A2 is the allowed max output current (PSU lifetime is around half of A1)

12V output

Mounting 1:

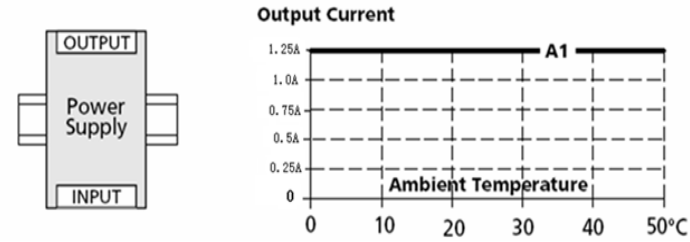

Mounting 2:

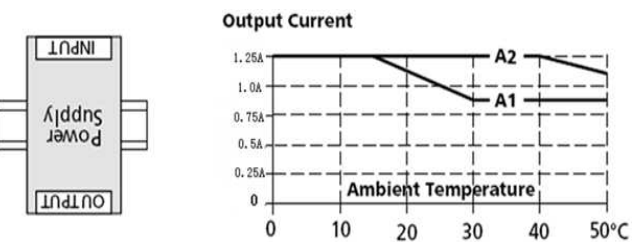

Mounting 3:

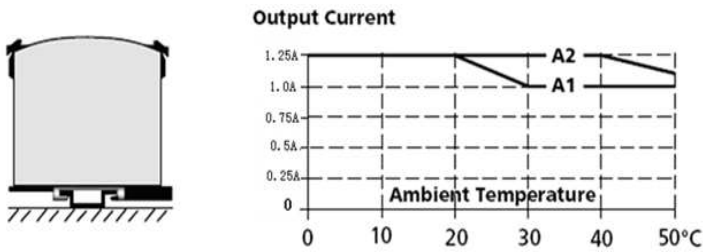

Mounting 4:

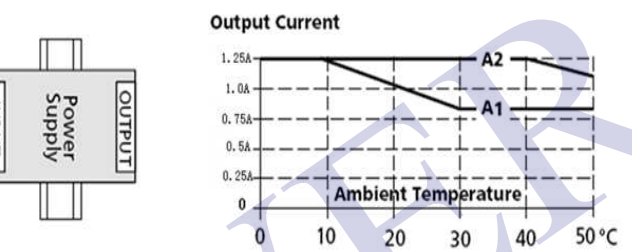

Mounting 5:

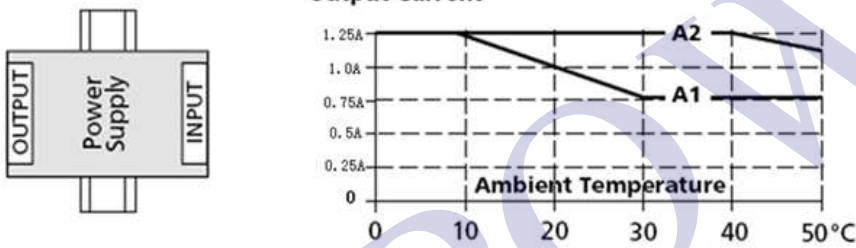

24V output

Mounting 1:

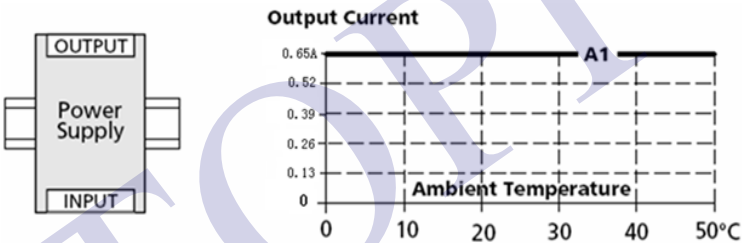

Mounting 2:

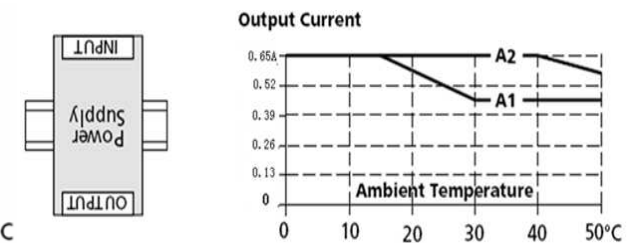

Mounting 3:

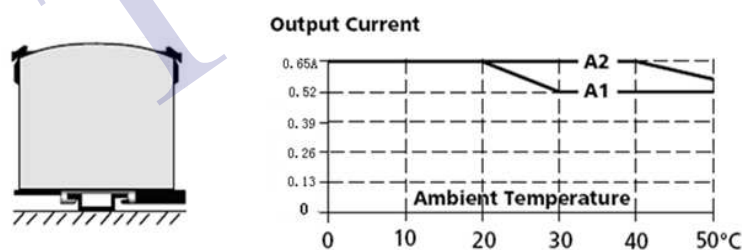

Mounting 4:

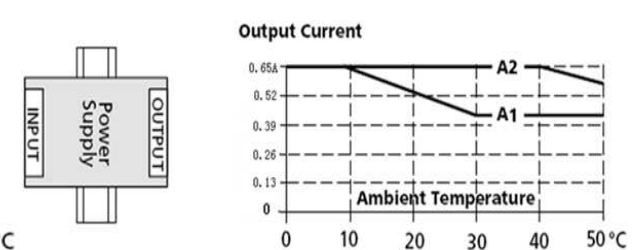

Mounting 5:

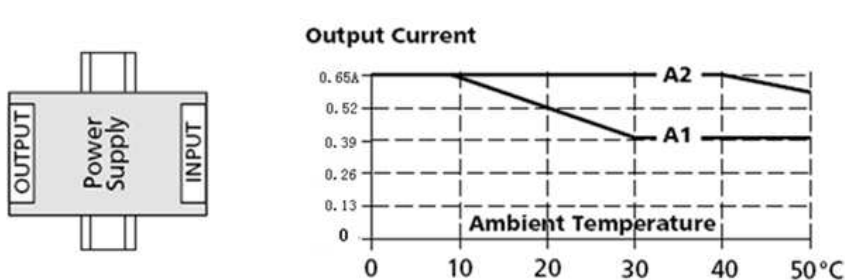

BLOCK DIAGRAM

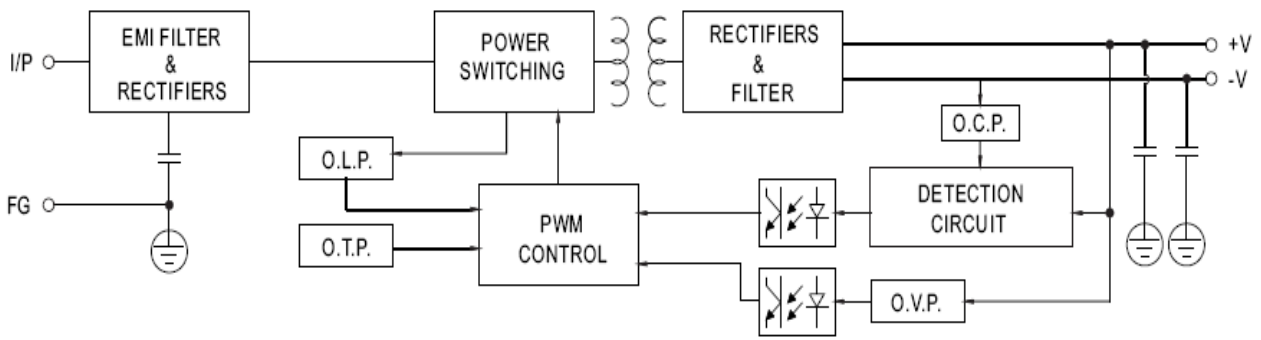

MODEL SELECTION

TP R / DG - 15 - 12 S

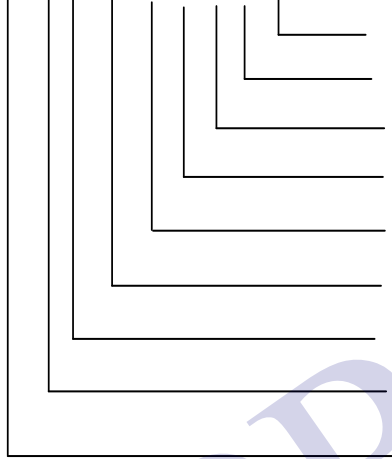

- S: Single output; D: Dual output
- Output voltage
- Delimiter
- Rated output Power
- Delimiter
- DIN RAIL Series
- Delimiter
- Type
- Brand
- TOPPOWER