



LIGITEK ELECTRONICS CO.,LTD.
Property of Ligitek Only

SURFACE MOUNT LED TAPE AND REEL



Lead-Free Parts

LURLVIR9553/R4

DATA SHEET

DOC. NO : QW0905-LURLVIR9553/R4

REV. : A

DATE : 22 - Mar. - 2016



Features:

1. Top view LED.
2. white SMT package.
3. Leadframe package with individual 4 pin.
4. Wide viewing angle.
5. Soldering methods: IR reflow soldering.
6. Feature of the device: more light due to higher optical efficiency; extremely wide viewing angle; ideal for backlighting and coupling in light guide.

Descriptions:

The LURLVIR9553 SMD has wide viewing angle and optimized light coupling by inter reflector, The low current requirement makes this device ideal for portable equipment or any other application where power is at a premium.

Applications:

1. Telecommunication: indicator and backlighting in telephone and fax.
2. Indicators.
3. Switch lights.

Device Selection Guide:

PART NO	MATERIAL	COLOR	
		Emitted	Lens
LURLVIR9553/R4	GaAIAs	Red	Water Clear
	GaAIAs	Infrared	

Package Dimensions

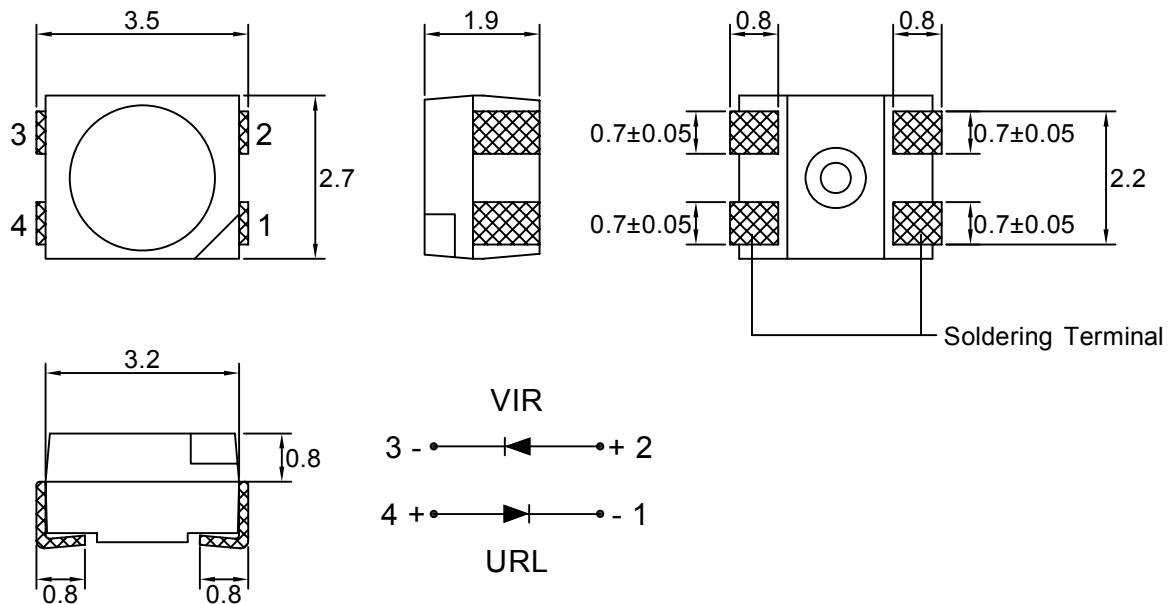

Note : 1.All dimension are in millimeter tolerance is $\pm 0.2\text{mm}$ unless otherwise noted.
2.Specifications are subject to change without notice.

Recommended Soldering Pad Dimensions

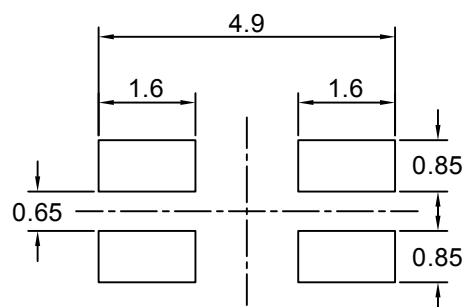

Note : The tolerances unless mentioned is $\pm 0.1\text{mm}$, Unit=mm.

Absolute Maximum Ratings at Ta=25°C

Parameter	Symbol	Ratings		UNIT
		URL	VIR	
Forward Current	IF	40	50	mA
Peak Forward Current Duty 1/10@10KHz	IFP	120	----	mA
Peak Forward Current (300PPS,10µs Pulse)	IFP	----	1	A
Power Dissipation	PD	96	80	mW
Reverse Current @5V	Ir	10	100	µA
Reverse Voltage	Vr	----	5	µA
Electrostatic Discharge	ESD	2000		V
Operating Temperature	Topr	- 40 ~ + 85		°C
Storage Temperature	Tstg	- 40 ~ + 100		°C

Typical Electrical & Optical Characteristics (Ta=25°C)

Items	Symbol	Min.	Typ.	Max.	UNIT	CONDITION
Radiant Intensity	Le	URL	1.8	3.0	----	mW/sr IF=20mA
		VIR	1.1	1.8	----	
Peak Wavelength	λP	URL	----	660	----	nm IF=20mA
		VIR	----	940	----	
Spectral Line Half-Width	Δλ	URL	----	20	----	nm IF=20mA
		VIR	----	50	----	
Forward Voltage	VF	URL	1.5	----	2.4	V IF=20mA
		VIR	1.1	----	1.6	
Viewing Angle	2θ 1/2	URL	----	120	----	deg IF=20mA
		VIR	----	120	----	

Note : 1.The forward voltage data did not including ±0.1V testing tolerance.
2 The luminous intensity data did not including +15% testing tolerance

Forward Voltage Classification

	Forward Voltage(V) at 20mA	
	Min.	Max.
URL	1.5	1.6
	1.6	1.7
	1.7	1.8
	1.8	1.9
	1.9	2.0
	2.0	2.1
	2.1	2.2
	2.2	2.3
	2.3	2.4

	Forward Voltage(V) at 20mA	
	Min.	Max.
VIR	1.1	1.2
	1.2	1.3
	1.3	1.4
	1.4	1.5
	1.5	1.6

Typical Electro-Optical Characteristics Curve

URL CHIP

Fig.1 Forward current vs. Forward Voltage

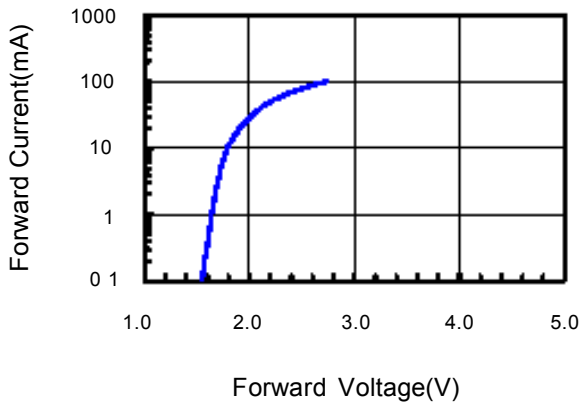

Fig.2 Relative Intensity vs. Forward Current

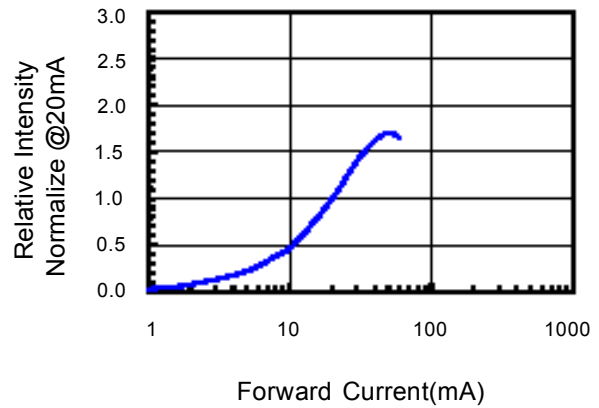

Fig.3 Forward Voltage vs. Temperature

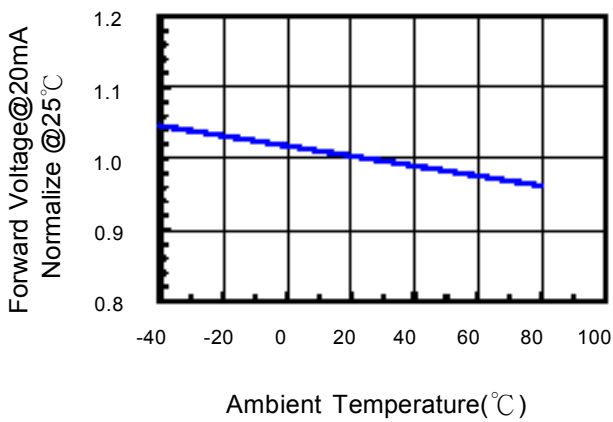

Fig.4 Relative Intensity vs. Temperature

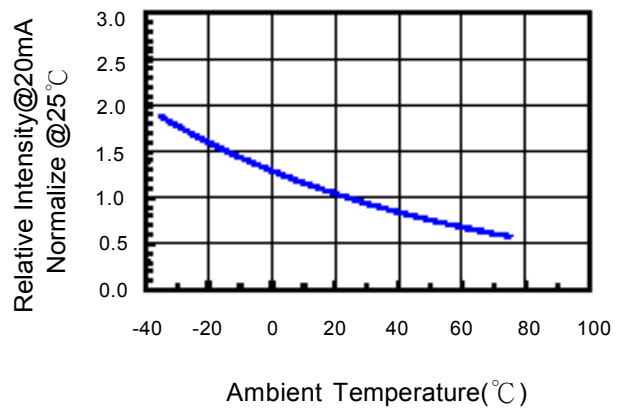

Fig.5 Relative Intensity vs. Wavelength

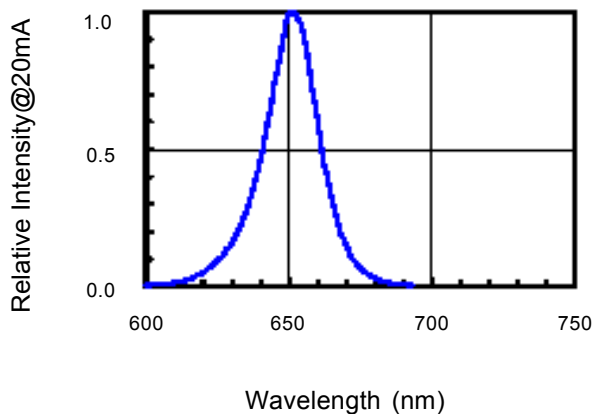
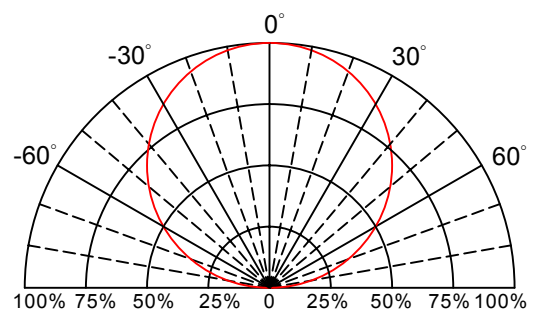

Fig.6 Directive Radiation



Typical Electro-Optical Characteristics Curve VIR CHIP

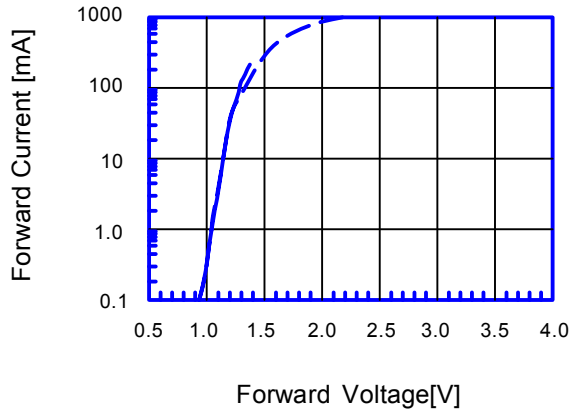

Fig.3. Relative Radiant Power vs. Forward Peak Current

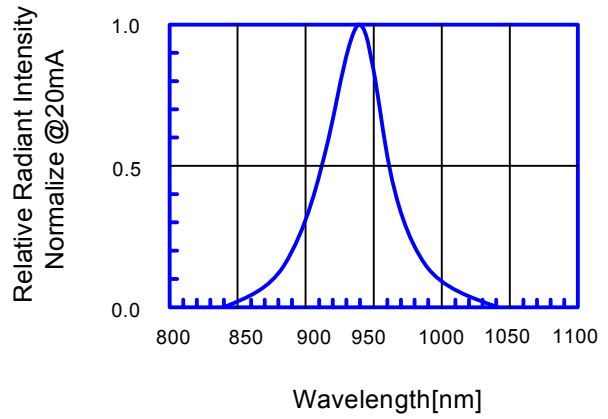

Fig.4 Relative Radiant Power vs. Forward Peak Current

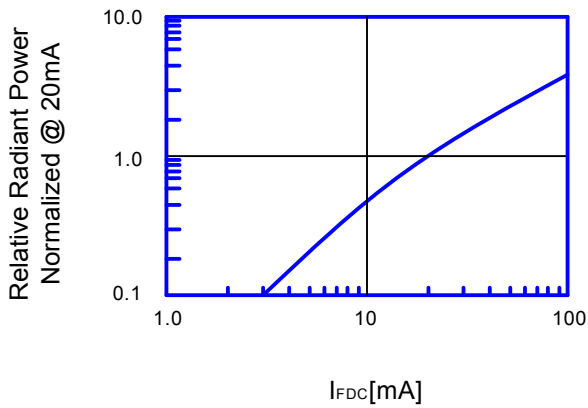

Fig.5 Forward DC Voltage vs. Temperature

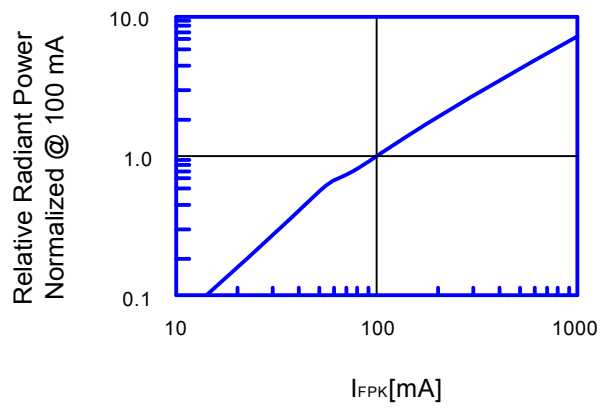
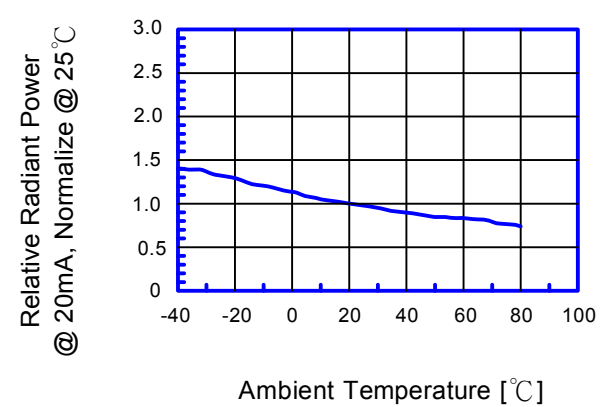
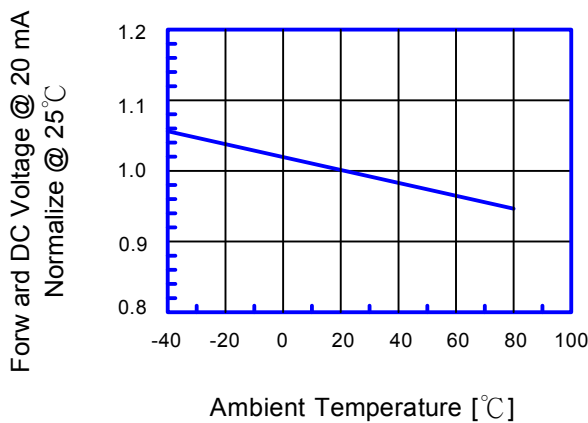
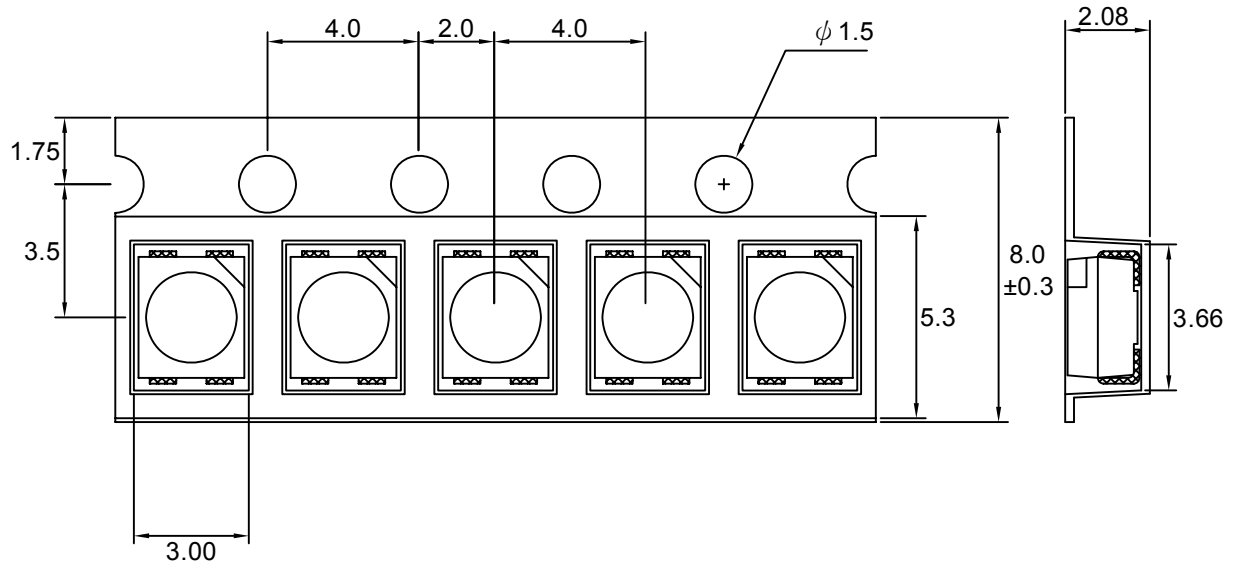

Fig.6 Relative Radiant Power vs. Temperature



Carrier Type Dimensions





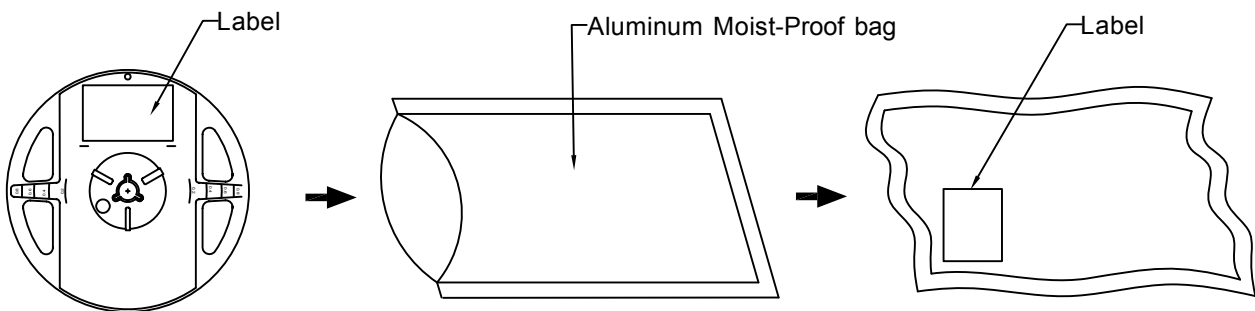

Note : The tolerances unless mentioned is ± 0.1 mm, Angle ± 0.5 . Unit=mm.

• Packing Specifications



Part No.	Description	Quantity/Reel
LURLVIR9553/R4	8.0mm tape,7"reel	2000 PCS

Label Explanation

	LIGITEK ELECTRONICS CO., LTD.
PART :	 LURLVIR9553/R4
LOT :	 GS11630168
QTY(PCS):	 2000
VF :	 URL 1.7-1.8V/VIR 1.2-1.3V

Reel Dimensions

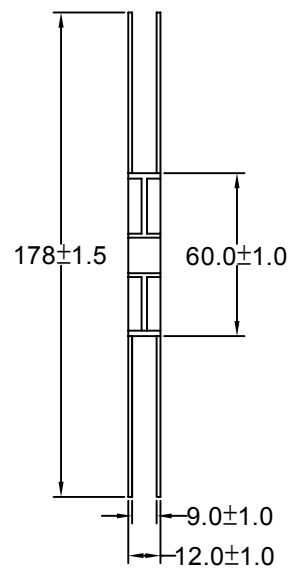
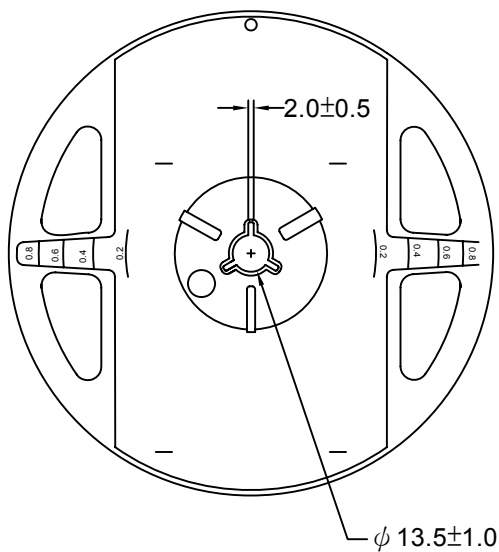

Box Explanation

1. 5 BAG / INNER BOX

2. INNER BOX SIZE : L X W X H 23cm X 8.5cm x 26cm

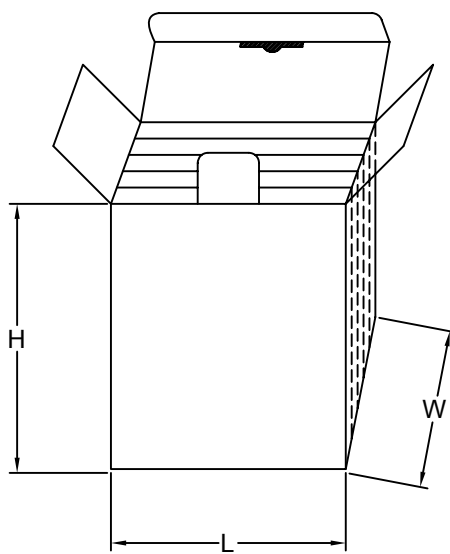

3. 10 INNER BOXES / CARTON

4. CARTON SIZE : L X W X H 58cm X 34cm x 35cm

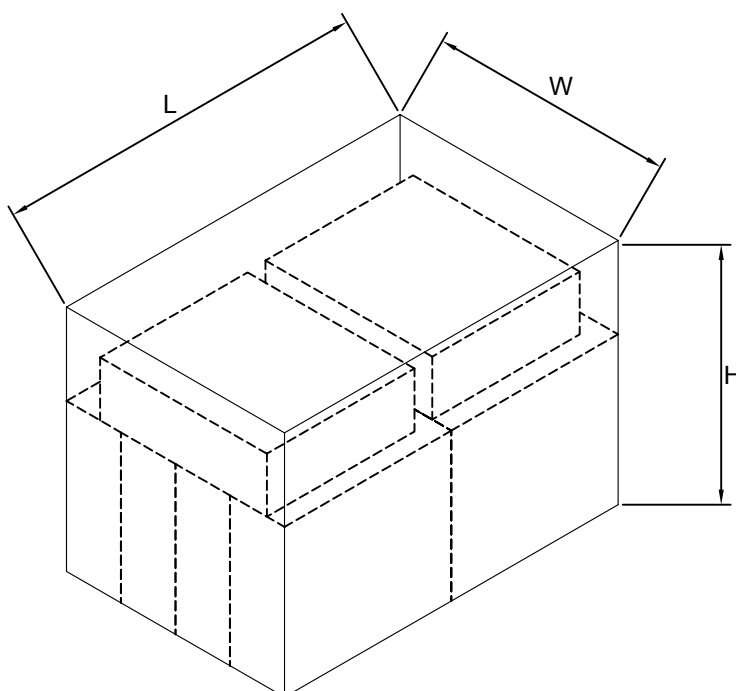

Recommended Soldering Conditions**1. Hand Solder**

Basic spec is $\leq 320^{\circ}\text{C}$ 3 sec one time only.

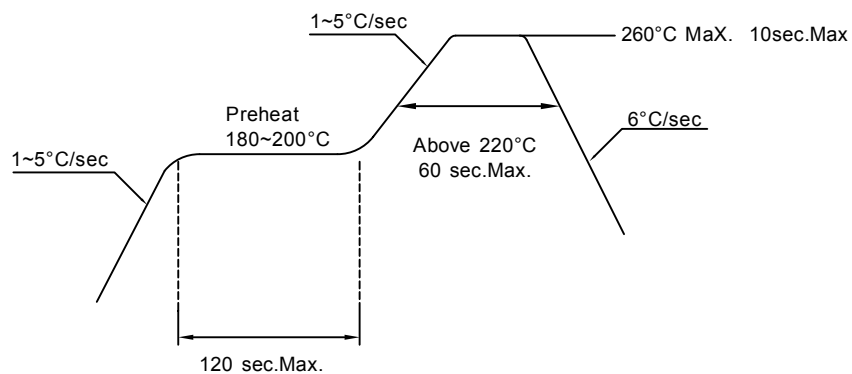
2. PB-Free Reflow Solder**Note:**

- 1.Reflow soldering should not be done more than two times.
- 2.When soldering,do not put stress on the LEDs during heating.
- 3.After soldering,do not warp the circuit board.

Precautions For Use:**Storage time:**

1. Calculated shelf life before opening is 12 months at $< 30^{\circ}\text{C}$ and $< 90\%$ relative humidity (RH)
2. After bag is opened, devices which will be subjected to reflow soldering or other high temperature processes must be
 - a) Assembled within 168 hours in an environment of $\leq 30^{\circ}\text{C} / 60\%$ RH, or
 - b) Stored at ambient of 10% RH or less
3. Devices are required baking before assembly if:
 - a) Humidity Indicator Card reads $>10\%$ (for level 2a -5a) or $>60\%$ (for level 2) at ambient temperature $23 \pm 5^{\circ}\text{C}$
 - b) 2.a) or 2.b) doesn't meet
4. If baking is required, devices should be baked for >24 hours at $60 \pm 5^{\circ}\text{C}$. Performing baking only once, and using the baked devices within 72 hours.

Drive Method:

LED is a current operated device, and therefore, requires some kind of current limiting incorporated into the driver circuit. This current limiting typically takes the form of a current limiting resistor placed in series with the LED.

Consider worst case voltage variations than could occur across the current limiting resistor. The forward current should not be allowed to change by more than 40% of its desired value.

Circuit model A

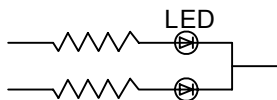

Circuit model B

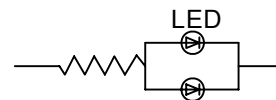

(A) Recommended circuit.

(B) The difference of brightness between LED could be found due to the VF-IF characteristics of LED.

Cleaning:

Use alcohol-based cleaning solvents such as isopropyl alcohol to clean the LED.

ESD(Electrostatic Discharge):

Static Electricity or power surge will damage the LED. Use of a conductive wrist band or anti-electrostatic glove is recommended when handling these LED. All devices, equipment and machinery must be properly grounded.

Reliability Test:

Classification	Test Item	Test Condition	Sample Size
Endurance Test	Operating Life Test	1.Ta=25°C 2.If=20mA 3.t=1000 hrs (-24hrs,+72hrs)	22
	High Temperature Storage Test	1.Ta=100°C±5°C 2.t=1000 hrs (-24hrs,+72hrs)	22
	Low Temperature Storage Test	1.Ta=-40°C±5°C 2.t=1000 hrs (-24hrs,+72hrs)	22
	High Temperature High Humidity Storage Test	1.Ta=85°C 2.RH=85% 3.t=1000hrs(-24hrs,+72hrs)	22
Environmental Test	Thermal Shock Test	1.Ta=100°C±5°C ~ -40°C±5°C 20min/ 10sec / 20min 2.total 100 cycles	22
	Temperature Cycling	1.100°C±5°C ~ -40°C±5°C 30mins / 5mins / 30mins 2.100 Cyeles	22
	IR Reflow	1.T=260°C Max. 10sec.Max. 2. 6 Min	22