

Type 550 105 °C High Ripple, Long-life, Inverter Grade, Aluminum

High Ripple, Long Life, Computer Grade



High Value, High Ripple Current

Type 550 is the original Inverter Grade capacitor for continuous operation at up to 105 °C and it now is available in low voltages too. For best value its load life test is 2000 hours instead of the 5000 hours of the Type 550C. While less than half the life capability of the Type 550C, it is lower cost and easily lasts more than 10 years in typical industrial applications.

Highlights

- 2,000 hour load life
- Ripple current to >50 amps
- ESRs to 2.5 mΩ

Specifications

RoHS Compliant

Operating Temperature:	-40 °C to +105 °C
Rated Voltage:	6.3 to 450 Vdc
Capacitance:	90 µF to 1.5 F
Capacitance Tolerance:	Vdc ≤ 150 V: -10 +75%, Vdc > 150 V: -10 +50%
DCLeakage Current:	≤3√CV µA (4 mA max.)
Ripple Current Multipliers:	Ambient Temperature

45 °C	55 °C	65 °C	75 °C	85 °C	95 °C	105 °C
1.73	1.58	1.41	1.22	1.00	0.71	0.57

Frequency

	50 Hz	60 Hz	120 Hz	360 Hz	1 kHz	5 kHz	10 kHz @ up
1 3/8 and 2 inch diameter							
≤ 50 V	0.77	0.85	1.00	1.05	1.08	1.08	1.08
51–299 V	0.75	0.83	1.00	1.15	1.20	1.20	1.20
≥300 V	0.72	0.80	1.00	1.30	1.40	1.40	1.40
2 1/2 and 3 inch diameter							
≤ 50 V	0.81	0.90	1.00	1.02	1.02	1.02	1.02
51–299 V	0.81	0.90	1.00	1.07	1.07	1.07	1.07
≥300 V	0.72	0.80	1.00	1.25	1.35	1.35	1.35

Load Life: 2,000 h at full load @ 105 °C

Shelf Life: 500 h @ 105 °C, Capacitance, ESR and DCL, initial requirements.

Vibration: 0 to 55 Hz, 0.06" and 10 g max, 1.5 h each of 2 axis

Type 550 105 °C High Ripple, Long-life, Inverter Grade, Aluminum Outline Drawing

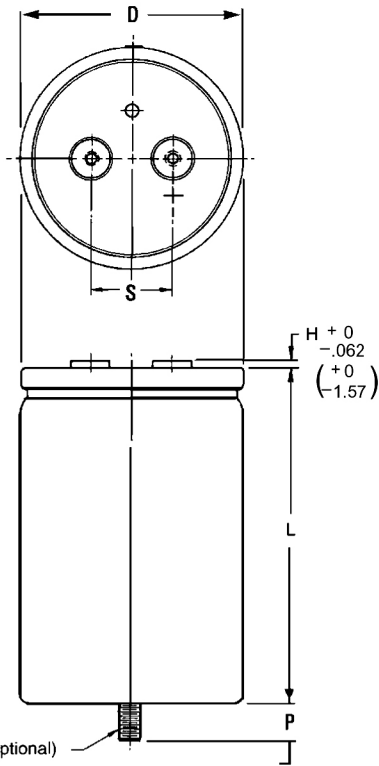

NOTE: With the stud-mount feature, a thermally-conductive disk can be inserted in the bottom flush with the outer insulating sleeve. This reduces the thermal resistance through the can bottom by 0.3 °C/W. Can Style P.

Stud Dimensions

Case Diam.	Stud Thread	P ± 0.039" (±1.0 mm)
1.38	M8	0.470" (12.0)
1.75	M8	0.470" (12.0)
2.00	M12	0.630" (16.0)
2.50	M12	0.630" (16.0)
3.00	M12	0.630" (16.0)

Insulated Case Dimensions

For bare can subtract 0.024" (0.61 mm) from D and 0.03" (0.76 mm) from L

Case Code	Diameter (D)		Length (L)		Terminals (S)		Typical Weight	
	±0.031 (in)	±0.78 (mm)	±0.062 (in)	±1.57 (mm)	±0.015 (in)	±0.38 (mm)	(oz)	(g)
AK	1.399	35.53	1.655	42.04	0.500	12.70	1.90	54
AA	1.399	35.53	2.155	54.74	0.500	12.70	2.00	57
AH	1.399	35.53	2.655	67.44	0.500	12.70	2.70	77
AB	1.399	35.53	3.155	80.14	0.500	12.70	3.30	94
AJ	1.399	35.53	3.655	92.84	0.500	12.70	3.80	108
AC	1.399	35.53	4.155	105.54	0.500	12.70	4.40	125
AD	1.399	35.53	4.655	118.24	0.500	12.70	5.10	145
AE	1.399	35.53	5.155	130.94	0.500	12.70	6.80	193
AF	1.399	35.53	5.655	143.64	0.500	12.70	8.10	230
BA	2.024	51.41	2.155	54.74	0.875	22.23	5.40	153
BH	2.024	51.41	2.655	67.44	0.875	22.23	6.10	173
BB	2.024	51.41	3.155	80.14	0.875	22.23	6.80	193
BJ	2.024	51.41	3.655	92.84	0.875	22.23	8.20	232
BC	2.024	51.41	1.155	29.34	0.875	22.23	9.50	269
BD	2.024	51.41	4.655	118.24	0.875	22.23	10.30	292
BE	2.024	51.41	5.155	130.94	0.875	22.23	10.70	303
BF	2.024	51.41	5.655	143.64	0.875	22.23	13.00	369
CB	2.524	64.11	3.155	80.14	1.125	28.58	10.40	295
CJ	2.524	64.11	3.655	92.84	1.125	28.58	12.73	361
CC	2.524	64.11	4.155	105.54	1.125	28.58	15.00	425
CD	2.524	64.11	4.655	118.24	1.125	28.58	17.20	488
CE	2.524	64.11	5.155	130.94	1.125	28.58	19.30	547
CF	2.524	64.11	5.655	143.64	1.125	28.58	21.40	607
DJ	3.024	76.81	3.655	92.84	1.250	31.75	20.00	567
DC	3.024	76.81	4.155	105.54	1.250	31.75	22.20	629
DD	3.024	76.81	4.655	118.24	1.250	31.75	25.50	723
DE	3.024	76.81	5.155	130.94	1.250	31.75	30.00	850
DF	3.024	76.81	5.655	143.64	1.250	31.75	31.90	904
DP	3.024	76.81	5.905	149.99	1.250	31.75	32.85	931
DG	3.024	76.81	8.655	219.84	1.250	31.75	43.30	1227

Terminal Style	Code	Post Diameter		H Maximum		Thread	min Full Thread		For Case Diameters
		(in)	(mm)	(in)	(mm)		(in)	(mm)	
Low Post	A	0.314	8.0	0.094	2.4	10-32	0.218	5.5	1 ³ / ₈ to 3
High Post	B	0.314	8.0	0.281	7.1	10-32	0.375	9.5	1 ³ / ₈ to 3
High Current, Low	D	0.684	17.4	0.125	3.2	¼-28	0.344	8.7	2½ & 3
High Current, High	E	0.684	17.4	0.281	7.1	¼-28	0.469	11.9	2½ & 3
Small M5 Post	M	0.314	8.0	0.281	7.1	M5	0.375	9.5	1 ³ / ₈ & 2
M5 Post	F	0.512	13.0	0.23	5.8	M5	0.344	8.7	2½ & 3
M6 Low Post	G	0.684	17.4	0.125	3.2	M6	0.344	8.7	2½ & 3
M6 High Post	H	0.684	17.4	0.281	7.1	M6	0.469	11.9	2½ & 3

[Click here to see Hardware & Mounting Options](#)

Type 550 105 °C High Ripple, Long-life, Inverter Grade, Aluminum

Part Numbering System

550	542	T	450	DG	2	D	S
Type	Capacitance	Tolerance	Voltage	Case Code	Insulation	Terminal	Can Style
	542 = 5400 μ F	M = \pm 20% U = 10%+75% T = -10%+50%	450 = 450 Vdc 016 = 16 Vdc 6R3 = 6.3 Vdc	0 = None 1 = Polyester 2 = PVC	A = Low Post B = High Post D = High Current, Low Post E = High Current, High Post F = M5 Post M = M5 Post, small G = M6 Low Post H = M6 High Post	Blank = Standard Can S = Stud Bottom P = Stud with Thermal Pad	

Standard insulation is 0.008-in PVC sleeve with 0.01-in polypropylene end disk.

Typical Performance Curves

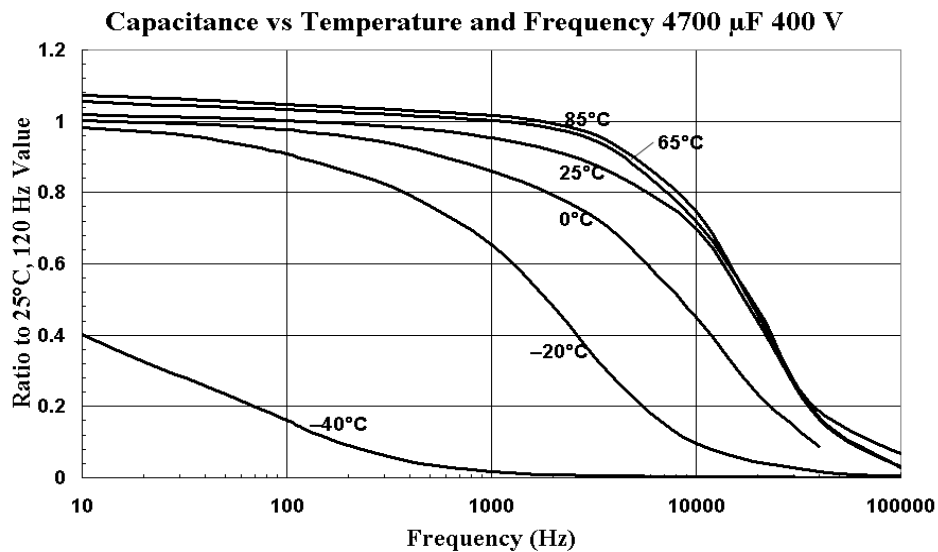
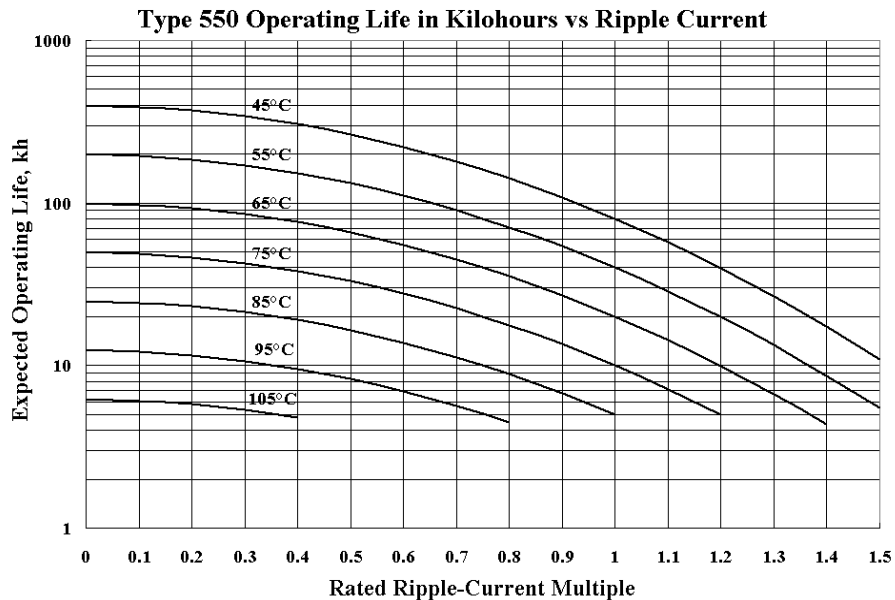

Type 550 105 °C High Ripple, Long-life, Inverter Grade, Aluminum

Typical Performance Curves

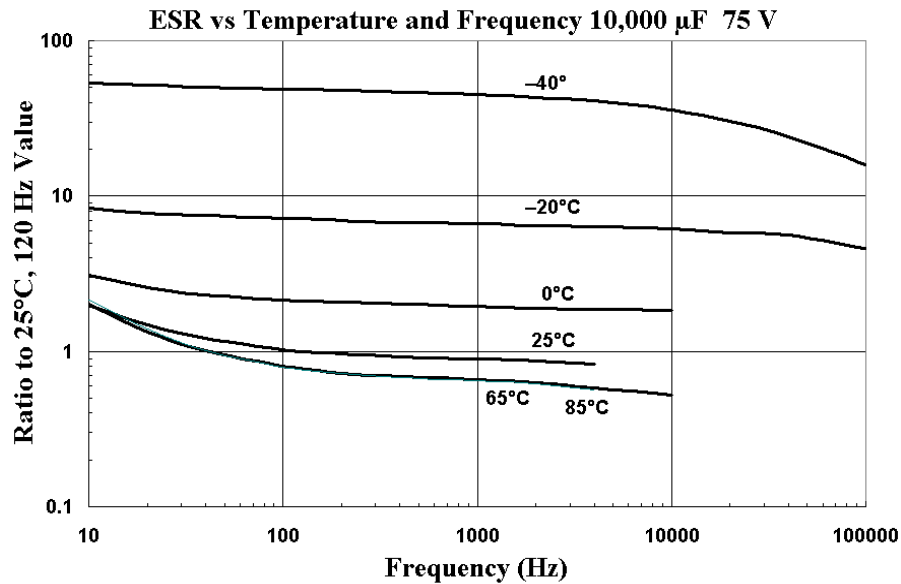
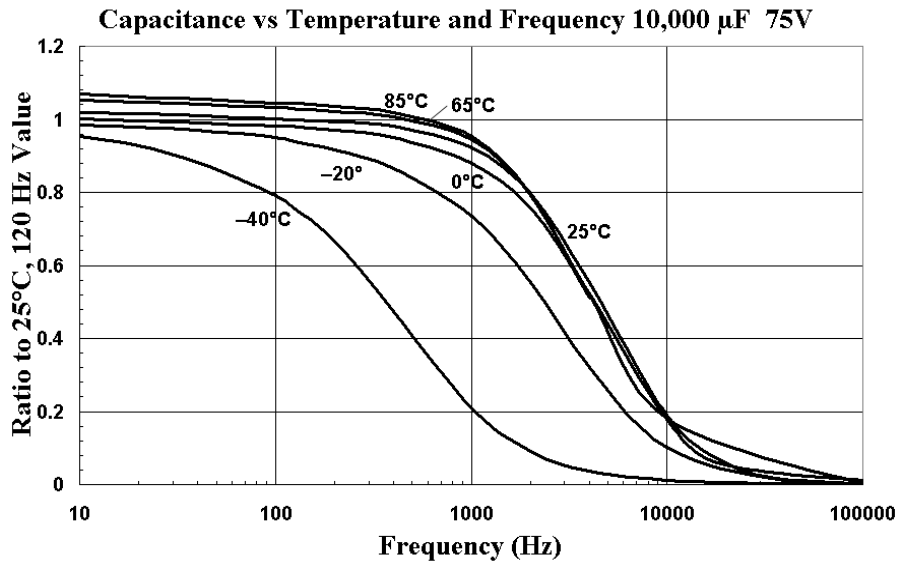
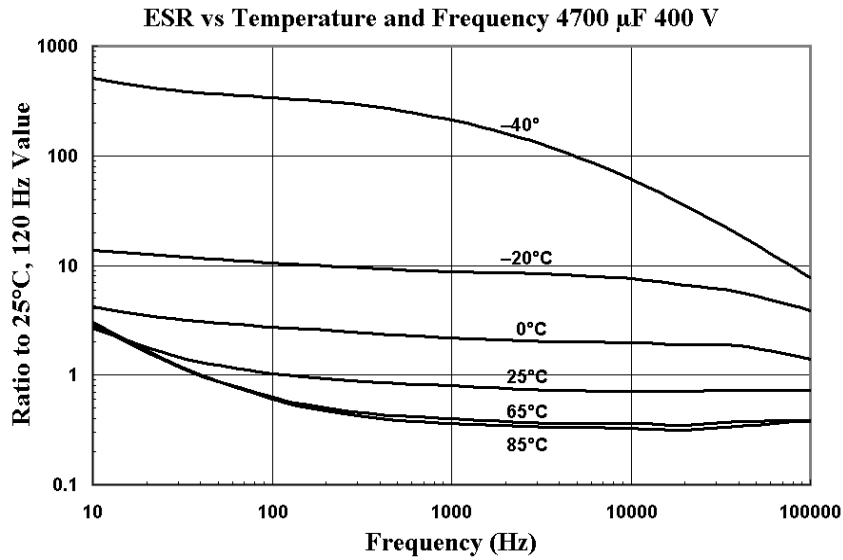

Type 550 105 °C High Ripple, Long-life, Inverter Grade, Aluminum

Typical Performance Curves

Impedance vs Temperature and Frequency 10,000 µF 75V

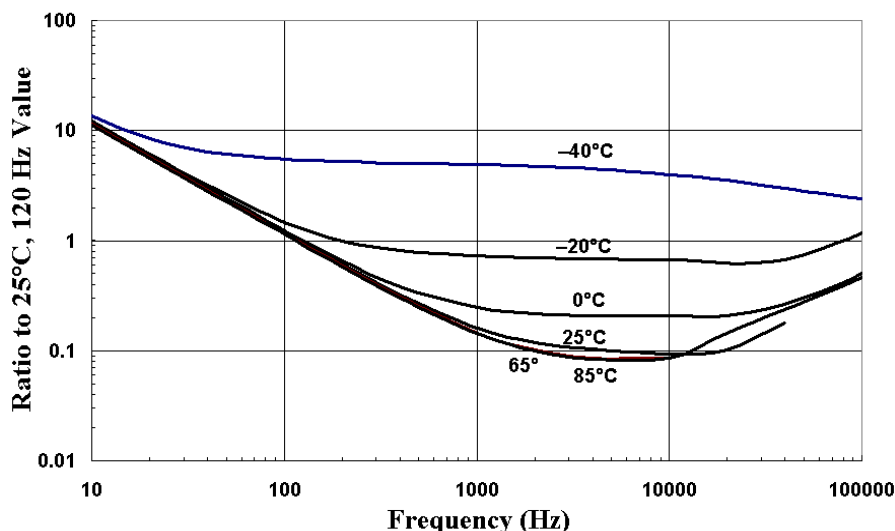

Ratings

Cap. (µF)	Catalog Part Number	ESR Max @ 25°C		Ripple Current Max @ 85°C		Nominal Size
		120Hz (mΩ)	20kHz (mΩ)	120Hz (A)	20kHz (A)	
6.3 Vdc (8 Vdc Surge)						
28,000	550283U6R3AK2B	49.5	33.5	5.0	6.0	1 ½ X 1 ½
47,000	550473U6R3AA2B	30.1	20.6	7.0	8.5	1 ½ X 2 ½
66,000	550663U6R3AH2B	21.9	15.1	8.9	10.7	1 ½ X 2 ½
85,000	550853U6R3AB2B	17.4	12.1	10.7	12.9	1 ½ X 3 ½
120,000	550124U6R3AC2B	12.7	9.0	14.1	16.7	1 ½ X 4 ½
170,000	550174U6R3BB2B	9.8	7.2	17.8	20.8	2 X 3 ½
180,000	550184U6R3AF2B	9.6	7.1	18.5	21.6	1 ½ X 5 ½
260,000	550264U6R3BC2B	6.9	5.2	23.6	27.3	2 X 4 ½
390,000	550394U6R3BF2D	5.1	3.9	30.8	35.1	2 X 5 ½
430,000	550434U6R3CC2D	4.6	3.5	33.2	37.8	2 ½ X 4 ½
610,000	550614U6R3DC2D	4.3	3.6	38.8	42.4	3 X 4 ½
640,000	550644U6R3CF2D	3.3	2.6	44.4	50.1	2 ½ X 5 ½
810,000	550814U6R3DE2D	3.4	2.9	46.8	50.0	3 X 5 ½
910,000	550914U6R3DF2D	3.1	2.6	50.0	50.0	3 X 5 ½
960,000	550964U6R3DP2D	3.0	2.5	50.0	50.0	3 X 5 ½
1,500,000	550155U6R3DG2D	2.9	2.5	50.0	50.0	3 X 8 ½
16 Vdc (20 Vdc Surge)						
17,000	550173U016AK2B	56.6	33.5	4.6	6.0	1 ½ X 1 ½
29,000	550293U016AA2B	34.4	20.6	6.5	8.5	1 ½ X 2 ½
41,000	550413U016AH2B	25.0	15.1	8.3	10.7	1 ½ X 2 ½
52,000	550523U016AB2B	19.8	12.1	10.0	12.9	1 ½ X 3 ½
75,000	550753U016AC2B	14.4	9.0	13.3	16.7	1 ½ X 4 ½
110,000	550114U016AF2B	10.7	7.1	17.5	21.6	1 ½ X 5 ½
110,000	550114U016BB2B	11.0	7.2	16.8	20.8	2 X 3 ½
160,000	550164U016BC2B	7.7	5.2	22.3	27.3	2 X 4 ½
240,000	550244U016BF2B	5.6	3.9	29.3	35.1	2 X 5 ½
260,000	550264U016CC2D	5.1	3.5	31.6	37.8	2 ½ X 4 ½
25 Vdc (30 Vdc Surge)						
380,000	550384U016DC2D	4.6	3.6	37.4	42.4	3 X 4 ½
390,000	550394U016CF2D	3.6	2.6	42.4	50.1	2 ½ X 5 ½
510,000	550514U016DE2D	3.6	2.9	45.2	50.0	3 X 5 ½
570,000	550574U016DF2D	3.3	2.6	49.0	50.0	3 X 5 ½
600,000	550604U016DP2D	3.2	2.5	50.0	50.0	3 X 5 ½
920,000	550924U016DG2D	3.1	2.5	50.0	50.0	3 X 8 ½
50 Vdc (65 Vdc Surge)						
4,000	550402U050AK2B	85.2	34.6	3.8	5.9	1 ½ X 1 ½
6,700	550672U050AA2B	51.6	21.2	5.3	8.3	1 ½ X 2 ½
9,400	550942U050AH2B	37.2	15.5	6.8	10.5	1 ½ X 2 ½
12,000	550123U050AB2B	29.3	12.5	8.3	12.7	1 ½ X 3 ½

Type 550 105 °C High Ripple, Long-life, Inverter Grade, Aluminum

Cap. (µF)	Catalog Part Number	ESR Max @ 25°C		Ripple Current Max @ 85°C		Nominal Size D x L (in.)	Cap. (µF)	Catalog Part Number	ESR Max @ 25°C		Ripple Current Max @ 85°C		Nominal Size D x L (in.)
		120Hz (mΩ)	20kHz (mΩ)	120Hz (A)	20kHz (A)				120Hz (mΩ)	20kHz (mΩ)	120Hz (A)	20kHz (A)	
50 Vdc (65 Vdc Surge) (continued)													
17,000	550173U050AC2B	21.0	9.3	11.0	16.5	1 3/8 X 4 1/8	31,000	550313U100CF2B	8.8	6.5	27.1	31.6	2 1/2 X 5 5/8
25,000	550253U050AF2B	15.2	7.2	14.7	21.3	1 3/8 X 5 5/8	31,000	550313U100DC2B	11.7	9.3	23.6	28.3	3 X 4 1/8
25,000	550253U050BB2B	15.7	7.4	14.1	20.5	2 X 3 3/8	42,000	550423U100DE2B	9.0	7.2	28.8	33.7	3 X 5 1/8
37,000	550373U050BC2B	10.8	5.3	18.8	27.0	2 X 4 1/8	47,000	550473U100DF2D	8.1	6.5	31.4	35.0	3 X 5 5/8
55,000	550553U050BF2B	7.7	4.0	25.0	34.7	2 X 5 5/8	49,000	550493U100DP2D	7.7	6.2	32.8	36.5	3 X 5 7/8
61,000	550613U050CC2B	7.0	3.6	26.9	37.5	2 1/2 X 4 1/8	68,000	550683U100DG2D	10.1	6.1	33.8	43.6	3 X 8 5/8
91,000	550913U050CF2D	4.9	2.6	36.5	49.7	2 1/2 X 5 5/8	200 Vdc - 250 Vdc Surge						
91,000	550913U050DC2D	5.9	3.7	33.2	42.1	3 X 4 1/8	320	550321T200AK2B	295.0	189.0	2.8	4.2	1 3/8 X 1 5/8
120,000	550124U050DE2D	4.6	2.9	40.3	50.6	3 X 5 1/8	520	550521T200AA2B	181.0	116.0	3.8	5.7	1 3/8 X 2 1/8
140,000	550144U050DF2D	4.2	2.7	43.8	54.7	3 X 5 5/8	750	550751T200AH2B	125.0	80.8	4.9	7.3	1 3/8 X 2 5/8
140,000	550144U050DP2D	4.0	2.6	45.7	50.0	3 X 5 7/8	980	550981T200AB2B	96.2	60.0	5.7	8.5	1 3/8 X 3 1/8
220,000	550224U050DG2D	3.8	2.5	50.0	50.0	3 X 8 5/8	1,200	550122T200AC2B	78.3	48.9	7.1	10.4	1 3/8 X 4 1/8
75 Vdc (100 Vdc Surge)													
2,300	550232U075AK2B	114.0	74.0	3.3	4.6	1 3/8 X 1 5/8	1,400	550142T200AF2B	66.1	40.2	8.5	12.2	1 3/8 X 5 5/8
3,800	550382U075AA2B	69.1	44.8	4.6	6.4	1 3/8 X 2 1/8	2,000	550202T200BB2B	51.2	32.6	9.9	14.0	2 X 3 1/8
5,300	550532U075AH2B	49.8	32.4	5.9	8.1	1 3/8 X 2 5/8	3,000	550302T200BC2B	33.7	21.6	12.6	17.6	2 X 4 1/8
6,900	550692U075AB2B	39.1	25.6	7.2	9.6	1 3/8 X 3 1/8	4,600	550462T200BF2B	22.6	14.6	15.4	21.1	2 X 5 5/8
9,900	550992U075AC2B	27.7	18.4	9.5	12.0	1 3/8 X 4 1/8	5,000	550502T200CC2B	21.2	13.8	18.3	24.6	2 1/2 X 4 1/8
14,000	550143U075BB2B	26.2	19.6	10.9	14.4	2 X 3 1/8	7,500	550752T200DC2B	17.5	12.6	21.8	27.0	3 X 4 1/8
15,000	550153U075AF2B	19.8	13.4	12.9	15.6	1 3/8 X 5 5/8	7,600	550762T200CF2B	14.2	9.2	22.5	29.8	2 1/2 X 5 5/8
21,000	550213U075BC2B	18.0	13.6	14.6	18.8	2 X 4 1/8	10,000	550103T200DE2B	13.3	9.2	25.5	31.3	3 X 5 1/8
31,000	550313U075BF2B	12.7	9.8	19.5	22.2	2 X 5 5/8	11,000	550113T200DF2B	11.8	8.3	27.0	33.0	3 X 5 5/8
35,000	550353U075CC2B	12.2	8.8	20.3	25.3	2 1/2 X 4 1/8	12,000	550123T200DP2B	11.2	8.1	27.4	33.4	3 X 5 7/8
52,000	550523U075CF2B	8.5	6.1	27.7	32.5	2 1/2 X 5 5/8	19,000	550193T200DG2B	13.0	11.0	25.1	27.0	3 X 8 5/8
52,000	550523U075DC2B	11.2	9.4	24.1	28.3	3 X 4 1/8	250 Vdc - 300 Vdc Surge						
69,000	550693U075DE2B	8.6	7.2	29.5	33.7	3 X 5 1/8	260	550261T250AK2B	341.0	196.0	2.8	4.2	1 3/8 X 1 5/8
77,000	550773U075DF2D	7.7	6.5	32.1	36.7	3 X 5 5/8	420	550421T250AA2B	209.0	120.0	3.6	5.6	1 3/8 X 2 1/8
82,000	550823U075DP2D	7.4	6.3	33.6	38.3	3 X 5 7/8	610	550611T250AH2B	145.0	81.8	4.6	7.2	1 3/8 X 2 5/8
110,000	550114U075DG2D	9.8	6.1	34.4	45.6	3 X 8 5/8	800	550801T250AB2B	104.0	60.7	5.5	8.4	1 3/8 X 3 1/8
100 Vdc (125 Vdc Surge)													
1,400	550142U100AK2B	140.0	87.3	2.9	4.3	1 3/8 X 1 5/8	990	550991T250AJ2B	84.7	52.6	6.3	9.7	1 3/8 X 3 5/8
2,300	550232U100AA2B	84.4	52.8	4.2	6.0	1 3/8 X 2 1/8	1,200	550122T250AC2B	71.5	42.0	6.8	10.4	1 3/8 X 4 1/8
3,200	550322U100AH2B	60.7	38.1	5.3	7.5	1 3/8 X 2 5/8	1,600	550162T250AE2B	54.8	32.5	8.2	15.3	1 3/8 X 5 5/8
4,200	550422U100AB2B	47.6	30.0	6.5	8.9	1 3/8 X 3 1/8	1,700	550172T250AF2B	49.2	29.3	8.2	12.1	1 3/8 X 5 5/8
6,000	550602U100AC2B	33.6	21.4	8.7	10.8	1 3/8 X 4 1/8	1,600	550162T250BB2B	56.8	33.0	9.3	13.8	2 X 3 1/8
8,500	550852U100BB2B	29.7	21.0	10.3	14.2	2 X 3 1/8	2,500	550252T250BC2B	36.1	21.8	11.9	17.4	2 X 4 1/8
8,800	550882U100AF2B	26.2	15.5	11.2	14.5	1 3/8 X 5 5/8	3,800	550382T250BF2B	24.1	14.8	14.5	21.0	2 X 5 5/8
13,000	550133U100BC2B	20.3	14.5	13.8	18.2	2 X 4 1/8	4,100	550412T250CC2B	24.2	14.0	14.5	20.9	2 1/2 X 4 1/8
19,000	550193U100BF2B	14.2	10.4	18.4	22.6	2 X 5 5/8	6,200	550622T250CF2B	15.2	9.3	21.4	29.5	2 1/2 X 5 5/8
21,000	550213U100CC2B	12.8	9.3	19.9	25.6	2 1/2 X 4 1/8	6,100	550612T250DC2B	19.8	12.7	21.0	26.9	3 X 4 1/8
							8,200	550822T250DE2B	14.0	9.3	24.5	31.1	3 X 5 1/8
							9,300	550932T250DF2B	12.0	8.4	25.9	32.8	3 X 5 5/8

Type 550 105 °C High Ripple, Long-life, Inverter Grade, Aluminum

Cap. (μ F)	Catalog Part Number	ESR Max @ 25°C		Ripple Current Max @ 85°C		Nominal Size D x L (in.)
		120Hz (m Ω)	20kHz (m Ω)	120Hz (A)	20kHz (A)	
300 Vdc (350 Vdc Surge)						
190	550191T300AK2B	625.0	414.0	2.1	3.3	1 ½ X 1 ½
310	550311T300AA2B	382.0	253.0	2.9	4.5	1 ½ X 2 ½
440	550441T300AH2B	260.0	176.0	3.7	5.7	1 ½ X 2 ½
580	550581T300AB2B	190.0	135.0	4.4	6.7	1 ½ X 3 ½
720	550721T300AC2B	154.0	103.0	5.0	7.8	1 ½ X 4 ½
850	550851T300AF2B	130.0	87.0	5.5	8.5	1 ½ X 5 ½
1,200	550122T300BB2B	101.0	69.8	7.7	11.6	2 X 3 ½
1,800	550182T300BC2B	66.0	43.0	9.9	14.9	2 X 4 ½
2,700	550272T300BF2B	43.8	28.7	11.9	17.8	2 X 5 ½
3,000	550302T300CC2B	45.7	31.7	14.5	20.7	2 ½ X 4 ½
4,500	550452T300CF2B	30.1	20.2	18.0	25.4	2 ½ X 5 ½
4,400	550442T300DC2B	30.6	21.2	18.2	24.8	3 X 4 ½
5,900	550592T300DE2B	22.9	15.9	22.1	29.0	3 X 5 ½
6,700	550672T300DF2B	20.4	14.2	22.6	30.9	3 X 5 ½
7,100	550712T300DP2B	19.3	14.0	23.2	31.2	3 X 5 ½
11,000	550113T300DG2B	17.1	14.8	26.0	27.9	3 X 8 ½
350 Vdc (400 Vdc Surge)						
160	550161T350AK2B	678.0	425.0	1.9	3.1	1 ½ X 1 ½
270	550271T350AA2B	414.0	260.0	2.7	4.3	1 ½ X 2 ½
390	550391T350AH2B	288.0	181.0	3.6	5.4	1 ½ X 2 ½
510	550511T350AB2B	206.0	139.0	4.2	6.4	1 ½ X 3 ½
630	550631T350AC2B	167.0	106.0	4.8	7.7	1 ½ X 4 ½
750	550751T350AF2B	141.0	89.4	5.3	8.4	1 ½ X 5 ½
1,000	550102T350BB2B	109.0	71.5	7.2	11.1	2 X 3 ½
1,600	550162T350BC2B	71.2	44.0	9.0	13.9	2 X 4 ½
2,400	550242T350BF2B	47.2	29.4	11.3	17.6	2 X 5 ½
2,600	550262T350CC2B	48.9	32.4	13.6	20.7	2 ½ X 4 ½
4,000	550402T350CF2B	31.8	20.4	16.9	24.9	2 ½ X 5 ½
3,900	550392T350DC2B	32.7	21.6	17.3	24.5	3 X 4 ½
5,300	550532T350DE2B	24.2	16.1	21.5	28.8	3 X 5 ½
6,000	550602T350DF2B	21.6	14.4	22.0	30.7	3 X 5 ½
6,300	550632T350DP2B	20.5	14.2	22.5	31.0	3 X 5 ½
10,000	550103T350DG2B	17.7	14.8	25.6	27.9	3 X 8 ½

Cap. (μ F)	Catalog Part Number	ESR Max @ 25°C		Ripple Current Max @ 85°C		Nominal Size D x L (in.)
		120Hz (m Ω)	20kHz (m Ω)	120Hz (A)	20kHz (A)	
400 Vdc (450 Vdc Surge)						
130	550131T400AK2B	731.0	437.0	1.9	3.1	1 ½ X 1 ½
210	550211T400AA2B	447.0	267.0	2.6	4.2	1 ½ X 2 ½
310	550311T400AH2B	310.0	185.0	3.4	5.3	1 ½ X 2 ½
400	550401T400AB2B	223.0	142.0	4.0	6.3	1 ½ X 3 ½
500	550501T400AC2B	181.0	109.0	4.6	7.6	1 ½ X 4 ½
590	550591T400AF2B	152.0	91.7	5.1	8.3	1 ½ X 5 ½
810	550811T400BB2B	117.0	73.2	6.9	10.9	2 X 3 ½
1,200	550122T400BC2B	76.4	45.1	8.7	13.7	2 X 4 ½
1,900	550192T400BF2B	50.7	30.1	10.9	17.4	2 X 5 ½
2,100	550212T400CC2B	52.1	33.0	12.8	19.6	2 ½ X 4 ½
3,100	550312T400CF2B	34.2	21.0	16.0	24.3	2 ½ X 5 ½
3,100	550312T400DC2B	34.8	22.0	16.7	24.3	3 X 4 ½
4,100	550412T400DE2B	26.0	16.6	20.7	28.5	3 X 5 ½
4,700	550472T400DF2B	23.2	14.8	21.2	30.3	3 X 5 ½
4,900	550492T400DP2B	22.0	14.5	21.8	30.6	3 X 5 ½
7,700	550772T400DG2B	18.9	15.2	24.7	27.6	3 X 8 ½
450 Vdc (500 Vdc Surge)						
90	550900T450AK2B	941.0	553.0	1.1	1.6	1 ½ X 1 ½
150	550151T450AA2B	570.0	338.0	1.6	2.3	1 ½ X 2 ½
210	550211T450AH2B	399.0	234.0	2.1	3.0	1 ½ X 2 ½
280	550281T450AB2B	305.0	180.0	2.6	3.7	1 ½ X 3 ½
350	550351T450AC2B	247.0	146.0	3.2	4.6	1 ½ X 4 ½
410	550411T450AF2B	208.0	123.0	4.0	5.7	1 ½ X 5 ½
560	550561T450BB2B	157.0	95.1	4.5	6.0	2 X 3 ½
870	550871T450BC2B	103.0	62.3	6.1	8.3	2 X 4 ½
1,300	550132T450BF2B	68.0	41.4	8.4	11.4	2 X 5 ½
1,400	550142T450CC2B	67.8	43.1	8.6	11.4	2 ½ X 4 ½
2,200	550222T450CF2B	45.0	28.8	12.0	15.8	2 ½ X 5 ½
2,100	550212T450DC2B	52.1	35.6	11.2	14.2	3 X 4 ½
2,900	550292T450DE2B	39.0	26.8	13.8	17.6	3 X 5 ½
3,200	550322T450DF2B	34.7	23.9	15.2	19.3	3 X 5 ½
3,400	550342T450DP2B	32.9	22.7	15.6	19.8	3 X 5 ½
5,400	550542T450DG2B	21.7	15.2	23.1	29.1	3 X 8 ½

Type 550 105 °C High Ripple, Long-life, Inverter Grade, Aluminum

Notice and Disclaimer: All product drawings, descriptions, specifications, statements, information and data (collectively, the "Information") in this datasheet or other publication are subject to change. The customer is responsible for checking, confirming and verifying the extent to which the Information contained in this datasheet or other publication is applicable to an order at the time the order is placed. All Information given herein is believed to be accurate and reliable, but it is presented without any guarantee, warranty, representation or responsibility of any kind, expressed or implied. Statements of suitability for certain applications are based on the knowledge that the Cornell Dubilier company providing such statements ("Cornell Dubilier") has of operating conditions that such Cornell Dubilier company regards as typical for such applications, but are not intended to constitute any guarantee, warranty or representation regarding any such matter – and Cornell Dubilier specifically and expressly disclaims any guarantee, warranty or representation concerning the suitability for a specific customer application, use, storage, transportation, or operating environment. The Information is intended for use only by customers who have the requisite experience and capability to determine the correct products for their application. Any technical advice inferred from this Information or otherwise provided by Cornell Dubilier with reference to the use of any Cornell Dubilier products is given gratis (unless otherwise specified by Cornell Dubilier), and Cornell Dubilier assumes no obligation or liability for the advice given or results obtained. Although Cornell Dubilier strives to apply the most stringent quality and safety standards regarding the design and manufacturing of its products, in light of the current state of the art, isolated component failures may still occur. Accordingly, customer applications which require a high degree of reliability or safety should employ suitable designs or other safeguards (such as installation of protective circuitry or redundancies or other appropriate protective measures) in order to ensure that the failure of an electrical component does not result in a risk of personal injury or property damage. Although all product-related warnings, cautions and notes must be observed, the customer should not assume that all safety measures are indicated in such warnings, cautions and notes, or that other safety measures may not be required.