

2.7V to 5.5V Input, 3A Integrated MOSFET Single Synchronous Buck DC/DC Converter

BD9A302QWZ

General Description

BD9A302QWZ is a synchronous buck DC/DC converter with built-in low on-resistance power MOSFETs. This IC is capable of providing current up to 3A. The SLLM™ control provides excellent efficiency characteristics in light-load conditions which make the product ideal for equipment and devices that demand minimal standby power consumption. The oscillating frequency is high at 1MHz using a small value of inductor. BD9A302QWZ is a current mode control DC/DC converter and features high-speed transient response. Phase compensation can also be set easily.

Features

- Single Synchronous Buck DC/DC Converter
- SLLM™ (Simple Light Load Mode) Control
- Over Current Protection
- Short Circuit Protection
- Thermal Shutdown Protection
- Under Voltage Lockout Protection
- UMMP008AZ020 Package (Backside Heat Dissipation)

Applications

- Step-Down Power Supply for DSPs, FPGAs, Microprocessors, etc.
- Laptop PCs / Tablet PCs / Servers
- LCD TVs
- Storage Devices (HDDs/SSDs)
- Printers, OA Equipment
- Distributed Power Supplies, Secondary Power Supplies

Key Specifications

- Input Voltage Range: 2.7V to 5.5V
- Output Voltage Range: 0.8V to $V_{IN} \times 0.7V$
- Output Current: 3A(Max)
- Switching Frequency: 1MHz(Typ)
- High-Side MOSFET ON-Resistance: 50mΩ (Typ)
- Low-Side MOSFET ON-Resistance: 50mΩ (Typ)
- Standby Current: 0μA (Typ)

Package

UMMP008AZ020 W (Typ) x D (Typ) x H (Max)
2.00mm x 2.00mm x 0.40mm

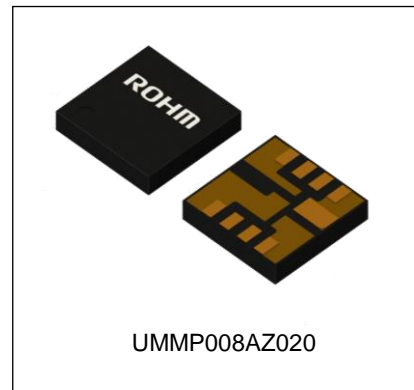

Typical Application Circuit

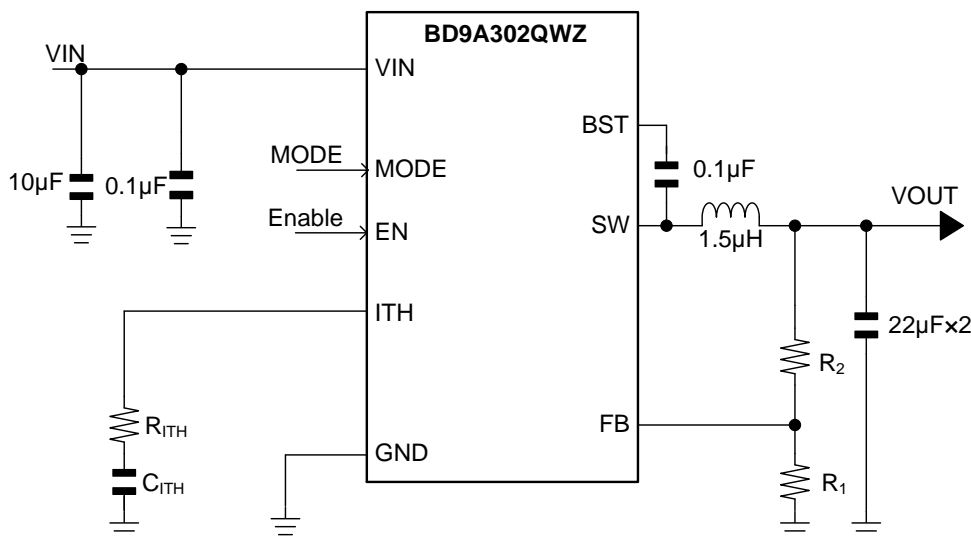

Figure 1. Application Circuit

Pin Configuration

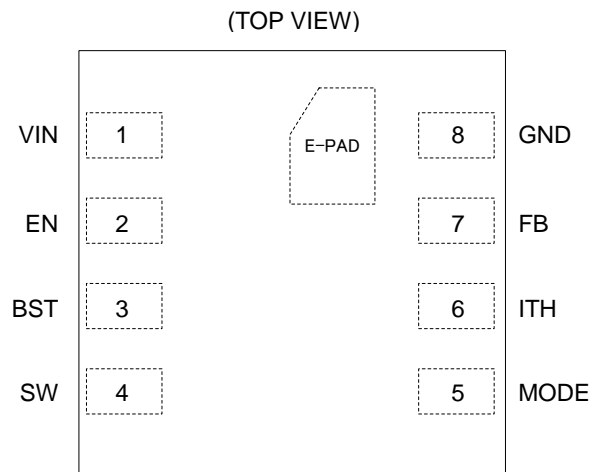

Figure 2. Pin Configuration

Pin Descriptions

| Pin No. | Pin Name | Function |
|---------|----------|---|
| 1 | VIN | Power supply terminal for the switching regulator and control circuit. Connecting 10 μ F and 0.1 μ F ceramic capacitors are recommended. |
| 2 | EN | Enable terminal. Turning this terminal signal Low (0.8V or lower) forces the device to enter the shutdown mode. Turning this terminal signal High (2.0V or higher) enables the device. The EN terminal must be properly terminated. |
| 3 | BST | Terminal for bootstrap. Connect a bootstrap capacitor of 0.1 μ F between this terminal and SW terminal. The voltage of the bootstrap capacitor is the gate drive voltage of the High-Side MOSFET. |
| 4 | SW | Switch terminal. The SW terminal is connected to the source of the High-Side MOSFET and drain of the Low-Side MOSFET. Connect a bootstrap capacitor of 0.1 μ F between the SW terminal and BST terminal. In addition, connect an inductor of 1.5 μ H considering the direct current superimposition characteristic. |
| 5 | MODE | Terminal for setting switching control mode. Turning this terminal signal Low (0.2V or lower) forces the device to operate in fixed frequency PWM mode. Turning this terminal signal High (0.8V or higher) enables the SLLM control and the mode is automatically switched between SLLM control and fixed frequency PWM mode. Do not change this terminal voltage during operation. |
| 6 | ITH | Terminal for the output of the error amplifier and the input of the current comparator. Connect phase compensation components to this terminal. |
| 7 | FB | Inverting input terminal for the error amplifier. |
| 8 | GND | Ground terminal for the output stage of the switching regulator and the control circuit. |
| - | E-PAD | Backside heat dissipation pad. Connecting to the PCB ground plane by using multiple vias provides excellent heat dissipation characteristics. |

Description of Blocks

1. VREF
The VREF block generates the internal reference voltage.
2. UVLO
The UVLO block is for under voltage lockout protection. It will shut down the IC when the VIN terminal voltage falls to 2.45V (Typ) or lower. The threshold voltage has a hysteresis of 100mV (Typ).
3. SCP
After the soft start is completed and when the feedback voltage of the output voltage has fallen below 0.4V (Typ) for 1ms (Typ), the SCP stops the operation for 16ms (Typ) and subsequently initiates restart.
4. OVP
The over voltage protection function (OVP) compares the FB terminal voltage with the internal reference voltage. When the FB terminal voltage exceeds 0.88V (Typ), it turns the output MOSFETs off. The output voltage returns with hysteresis after the output voltage drops to normal operation level.
5. TSD
The TSD block is for thermal protection. The thermal protection circuit shuts down the device when the internal temperature of IC rises to 175°C (Typ) or higher. Thermal protection circuit resets when the temperature falls. The circuit has a hysteresis of 25°C (Typ).
6. Soft Start
When EN terminal is switched High, Soft Start operates and the output voltage gradually rises. With the Soft Start Function, overshoot of output voltage and rush current can be prevented. The internal soft start time is set to 1ms (Typ).
7. Error Amplifier
The error amplifier block compares the internal reference voltage with the feedback voltage of the output voltage. The error and the ITH terminal voltage determine the switching duty. A soft start is applied at startup. The ITH terminal voltage is limited by the internal slope voltage.
8. Current Comparator
The Current Comparator block compares the output ITH terminal voltage of the error amplifier and the slope block signal to determine the switching duty. In the event of over current, the current that flows through the High-Side MOSFET is limited at each cycle of the switching frequency.
9. OSC
This block is the oscillator.
10. Driver Logic
This block is the DC/DC driver. A signal from current comparator is applied to drive the MOSFETs.

Absolute Maximum Ratings (Ta = 25°C)

| Parameter | Symbol | Rating | Unit |
|------------------------------|-------------------|-------------------------------|------|
| Input Voltage | V _{IN} | -0.3 to +7 | V |
| EN Terminal Voltage | V _{EN} | -0.3 to +7 | V |
| MODE Terminal Voltage | V _{MODE} | -0.3 to +7 | V |
| Voltage from GND to BST | V _{BST} | -0.3 to +14 | V |
| Voltage from SW to BST | ΔV _{BST} | -0.3 to +7 | V |
| FB Terminal Voltage | V _{FB} | -0.3 to +7 | V |
| ITH Terminal Voltage | V _{ITH} | -0.3 to +7 | V |
| SW Terminal Voltage | V _{SW} | -0.3 to V _{IN} + 0.3 | V |
| Storage Temperature Range | T _{stg} | -55 to +150 | °C |
| Maximum Junction Temperature | T _{jmax} | 150 | °C |

Caution1: Operating the IC over the absolute maximum ratings may damage the IC. The damage can either be a short circuit between pins or an open circuit between pins and the internal circuitry. Therefore, it is important to consider circuit protection measures, such as adding a fuse, in case the IC is operated over the absolute maximum ratings.

Caution 2: Should by any chance the maximum junction temperature rating be exceeded the rise in temperature of the chip may result in deterioration of the properties of the chip. In case of exceeding this absolute maximum rating, increase the board size and copper area to prevent exceeding the maximum junction temperature rating.

Thermal Resistance (Note 1)

| Parameter | Symbol | Thermal Resistance (Typ) | | Unit |
|--|-----------------|--------------------------|--------------------------|------|
| | | 1s ^(Note 3) | 2s2p ^(Note 4) | |
| UMMP008AZ020 | | | | |
| Junction to Ambient | θ _{JA} | 376.0 | 67.8 | °C/W |
| Junction to Top Characterization Parameter ^(Note 2) | Ψ _{JT} | 92.0 | 18.0 | °C/W |

(Note 1) Based on JESD51-2A (Still-Air)

(Note 2) The thermal characterization parameter to report the difference between junction temperature and the temperature at the top center of the outside surface of the component package.

(Note 3) Using a PCB board based on JESD51-3.

| Layer Number of Measurement Board | Material | Board Size |
|-----------------------------------|-----------|---------------------------|
| Single | FR-4 | 114.3mm x 76.2mm x 1.57mm |
| Top | | |
| Copper Pattern | Thickness | |
| Footprints and Traces | 70μm | |

(Note 4) Using a PCB board based on JESD51-5, 7.

| Layer Number of Measurement Board | Material | Board Size | Thermal Via ^(Note 5) | | |
|-----------------------------------|-----------|--------------------------|---------------------------------|-----------------|-----------|
| | | | Pitch | Diameter | |
| 4 Layers | FR-4 | 114.3mm x 76.2mm x 1.6mm | - | Φ0.30mm | |
| Top | | 2 Internal Layers | | Bottom | |
| Copper Pattern | Thickness | Copper Pattern | Thickness | Copper Pattern | Thickness |
| Footprints and Traces | 70μm | 74.2mm x 74.2mm | 35μm | 74.2mm x 74.2mm | 70μm |

(Note 5) This thermal via connects with the copper pattern of all layers.

Recommended Operating Conditions

| Parameter | Symbol | Min | Typ | Max | Unit |
|-----------------------------|--------------------|-----|-----|-----------------------|------|
| Input Voltage | V _{IN} | 2.7 | - | 5.5 | V |
| Operating Temperature Range | Topr | -40 | - | +85 | °C |
| Output Current | I _{OUT} | 0 | - | 3 | A |
| Output Voltage Range | V _{RANGE} | 0.8 | - | V _{IN} × 0.7 | V |

Electrical Characteristics (Unless otherwise specified Ta = 25°C, V_{IN} = 5V, V_{EN} = 5V)

| Parameter | Symbol | Min | Typ | Max | Unit | Conditions |
|--|--------------------|-------|------|-----------------|------|---|
| INPUT SUPPLY | | | | | | |
| Standby Supply Current | I _{STB} | - | 0 | 10 | μA | V _{EN} = GND |
| Operating Supply Current | I _{CC} | - | 350 | 500 | μA | I _{OUT} = 0mA Non-switching |
| UVLO Detection Voltage | V _{UVLO1} | 2.35 | 2.45 | 2.55 | V | V _{IN} Falling |
| UVLO Release Voltage | V _{UVLO2} | 2.425 | 2.55 | 2.7 | V | V _{IN} Rising |
| ENABLE | | | | | | |
| EN Input High Level Voltage | V _{ENH} | 2.0 | - | V _{IN} | V | |
| EN Input Low Level Voltage | V _{ENL} | GND | - | 0.8 | V | |
| EN Input Current | I _{EN} | - | 5 | 10 | μA | V _{EN} = 5V |
| MODE | | | | | | |
| MODE Threshold Voltage | V _{MODEH} | 0.2 | 0.4 | 0.8 | V | |
| MODE Input Current | I _{MODE} | - | 10 | 20 | μA | V _{MODE} = 5V |
| Reference Voltage, Error Amplifier | | | | | | |
| FB Terminal Voltage | V _{FB} | 0.792 | 0.8 | 0.808 | V | |
| FB Input Current | I _{FB} | - | 0 | 1 | μA | V _{FB} = 0.8V |
| ITH Sink Current | I _{THSI} | 10 | 20 | 40 | μA | V _{FB} = 0.9V |
| ITH Source Current | I _{THSO} | 10 | 20 | 40 | μA | V _{FB} = 0.7V |
| Soft Start Time | t _{SS} | 0.5 | 1.0 | 2.0 | ms | |
| SWITCHING FREQUENCY | | | | | | |
| Switching Frequency | f _{OSC} | 800 | 1000 | 1200 | kHz | |
| SWITCH MOSFET | | | | | | |
| High Side FET ON Resistance | R _{ONH} | - | 50 | 100 | mΩ | V _{BST} - V _{SW} = 5V |
| Low Side FET ON Resistance | R _{ONL} | - | 50 | 100 | mΩ | |
| High Side Output Leakage Current | I _{LH} | - | 0 | 10 | μA | Non-switching |
| Low Side Output Leakage Current | I _{LL} | - | 0 | 10 | μA | Non-switching |
| SCP | | | | | | |
| Short Circuit Protection Detection Voltage | V _{SCP} | 0.28 | 0.4 | 0.52 | V | |

Typical Performance Curves

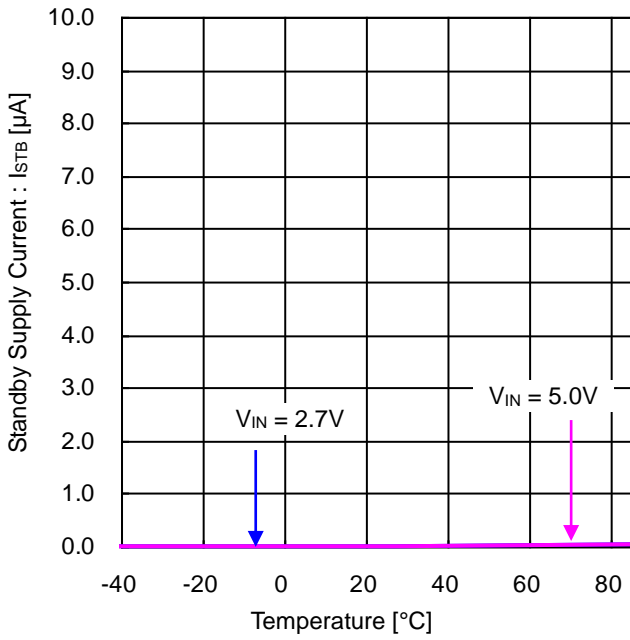

Figure 4. Standby Supply Current vs Temperature

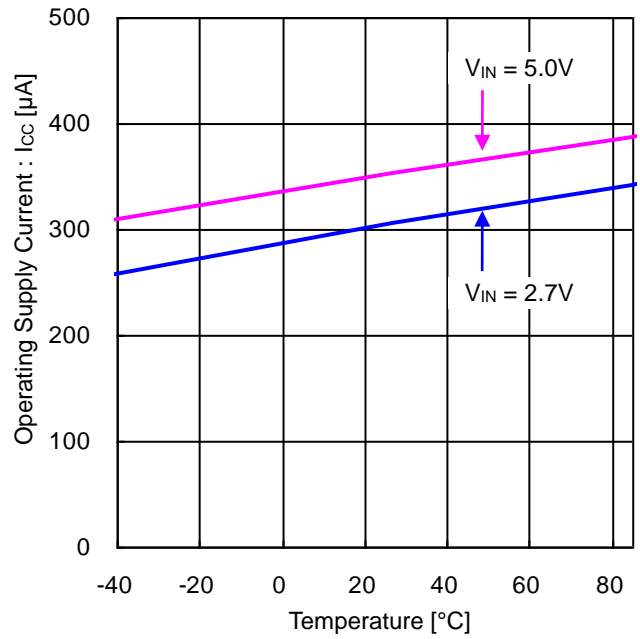

Figure 5. Operating Supply Current vs Temperature

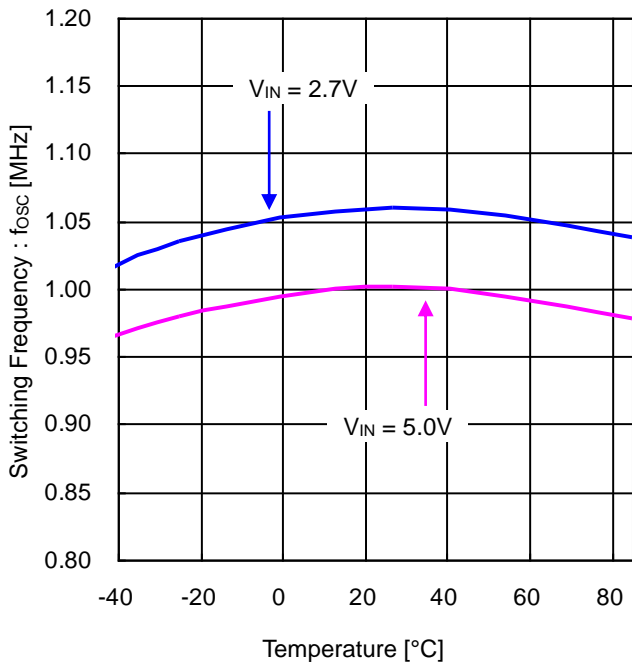

Figure 6. Switching Frequency vs Temperature

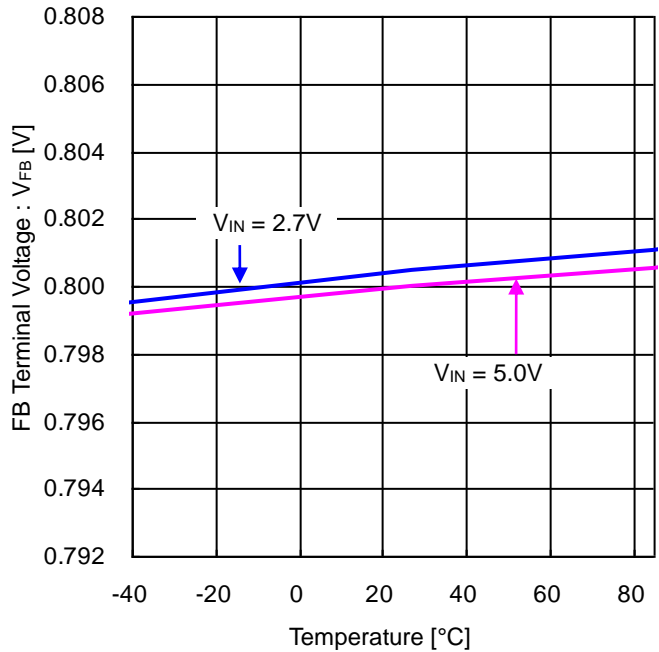

Figure 7. FB Terminal Voltage vs Temperature

Typical Performance Curves - continued

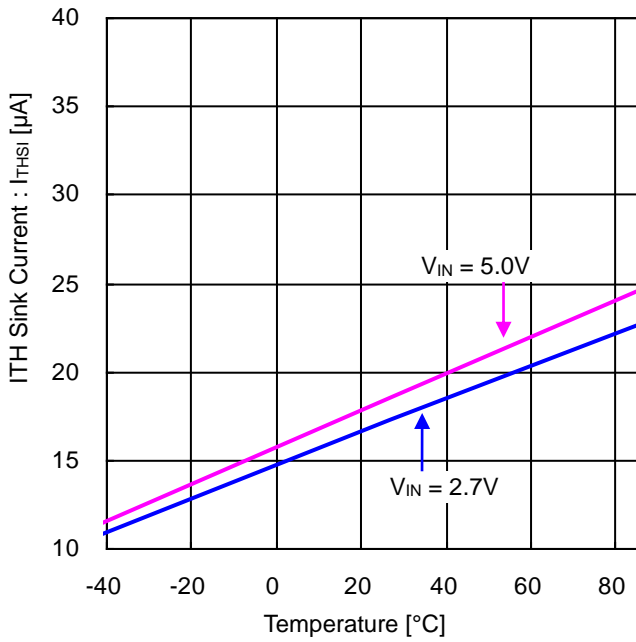

Figure 8. ITH Sink Current vs Temperature

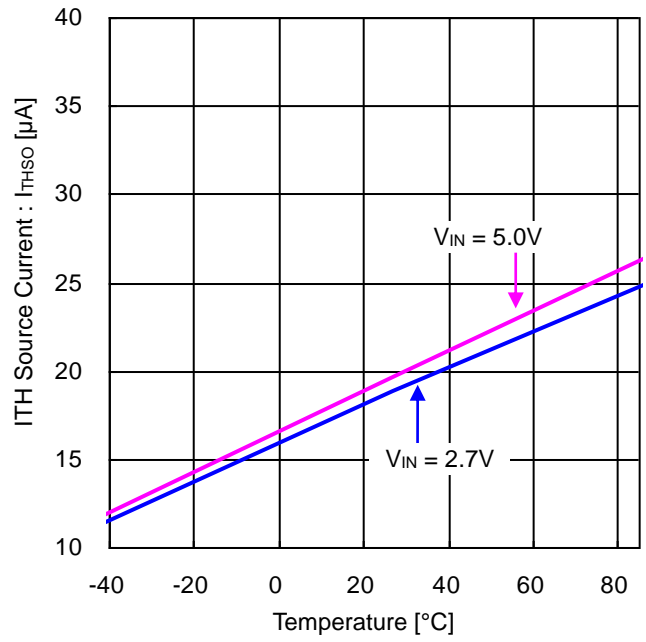

Figure 9. ITH Source Current vs Temperature

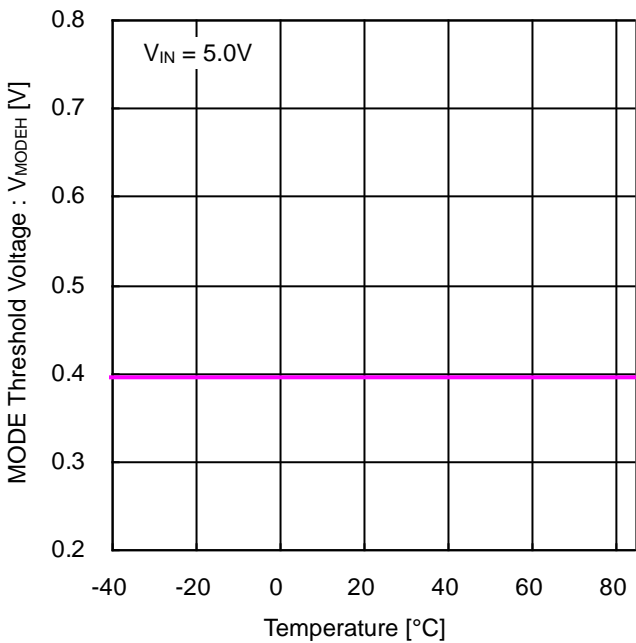

Figure 10. MODE Threshold Voltage vs Temperature

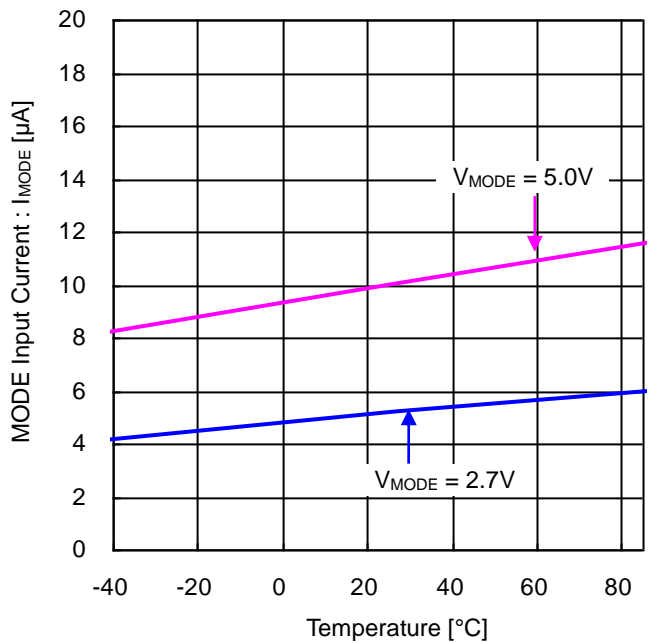

Figure 11. MODE Input Current vs Temperature

Typical Performance Curves - continued

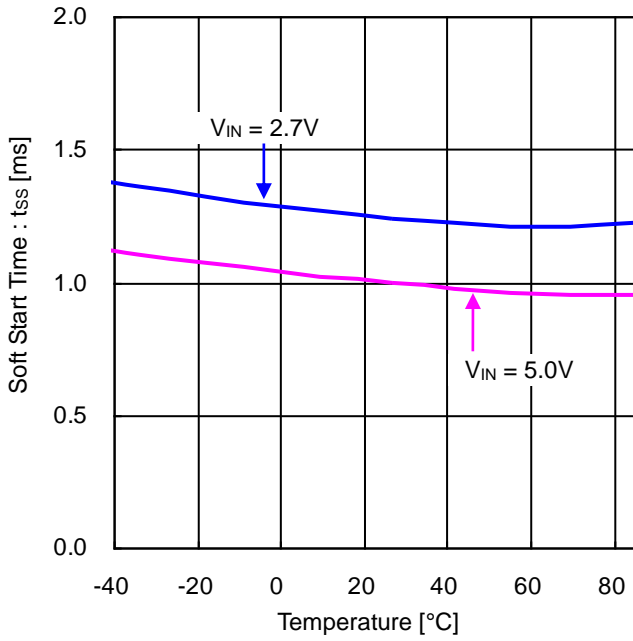

Figure 12. Soft Start Time vs Temperature

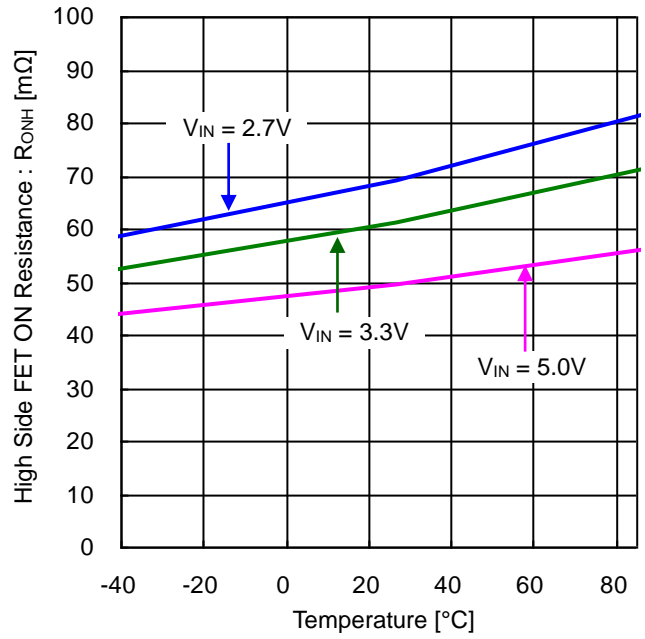

Figure 13. High Side FET ON Resistance vs Temperature

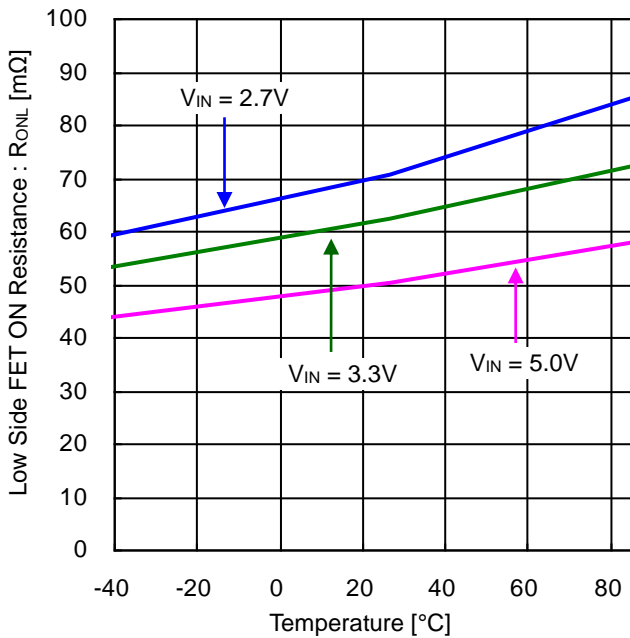

Figure 14. Low Side FET ON Resistance vs Temperature

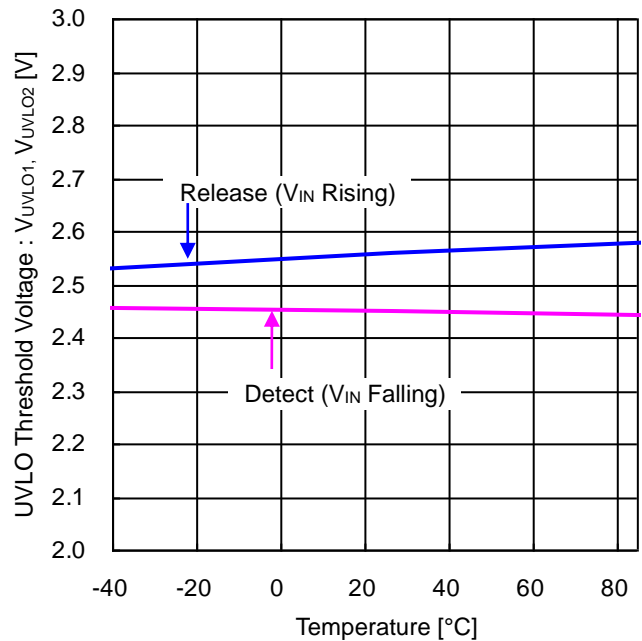

Figure 15. UVLO Detection / Release Voltage vs Temperature

Typical Performance Curves - continued

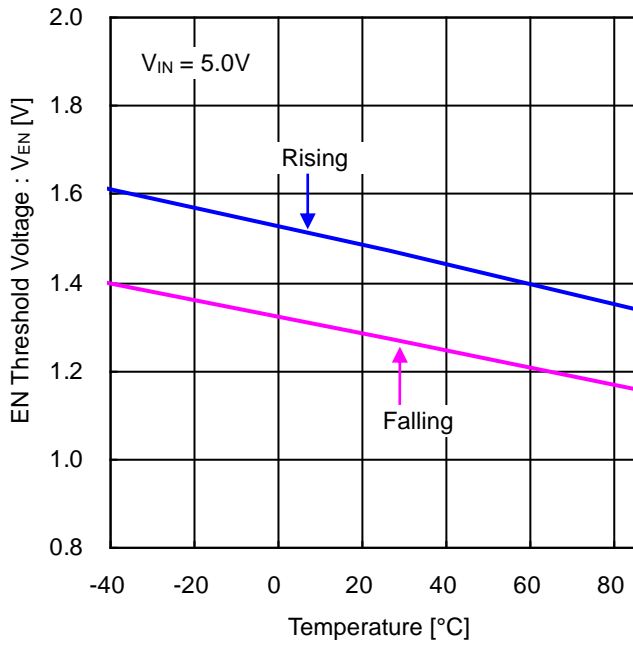

Figure 16. EN Threshold Voltage vs Temperature

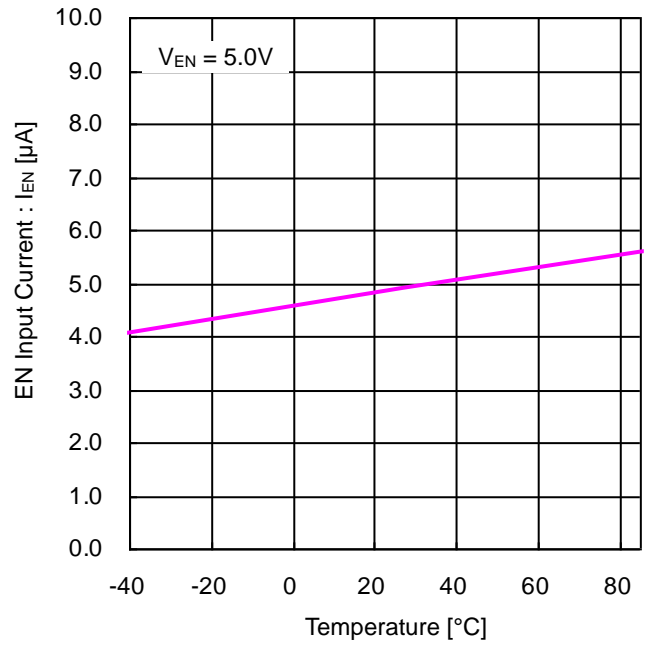

Figure 17. EN Input Current vs Temperature

Typical Performance Curves (Application)

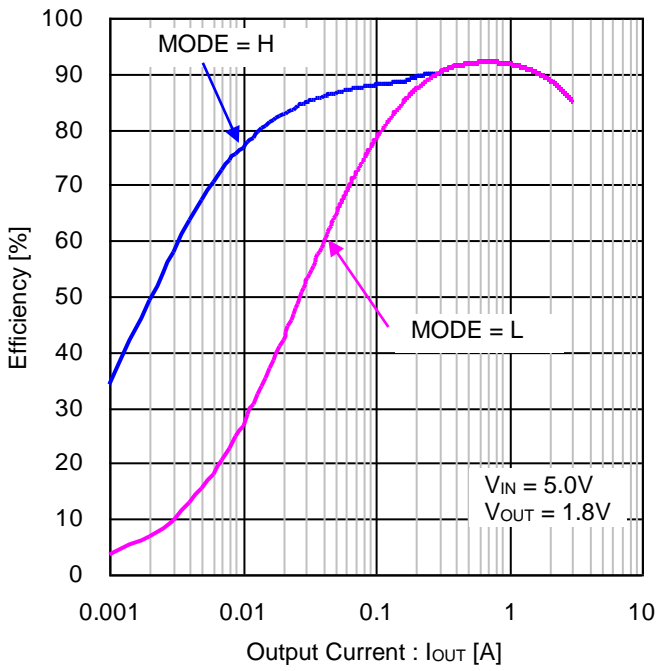

Figure 18. Efficiency vs Output Current
($V_{IN} = 5V$, $V_{OUT} = 1.8V$, $L = 1.5\mu H$)

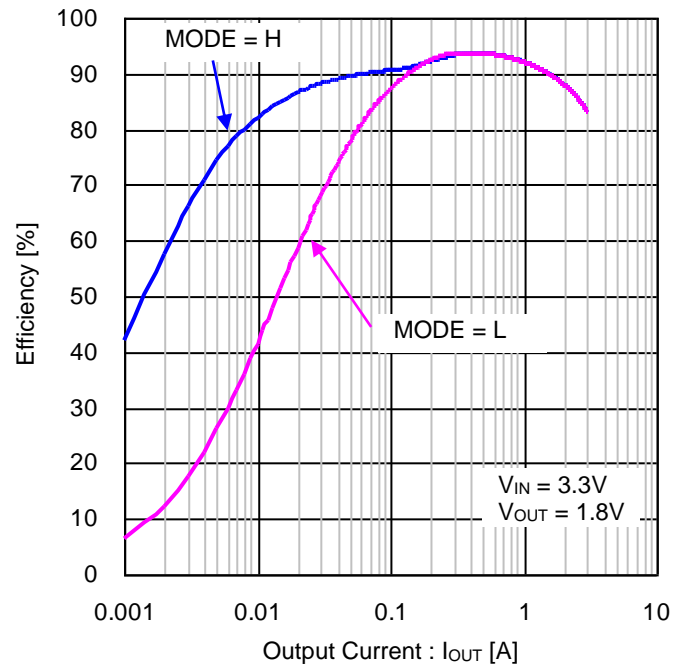

Figure 19. Efficiency vs Output Current
($V_{IN} = 3.3V$, $V_{OUT} = 1.8V$, $L = 1.5\mu H$)

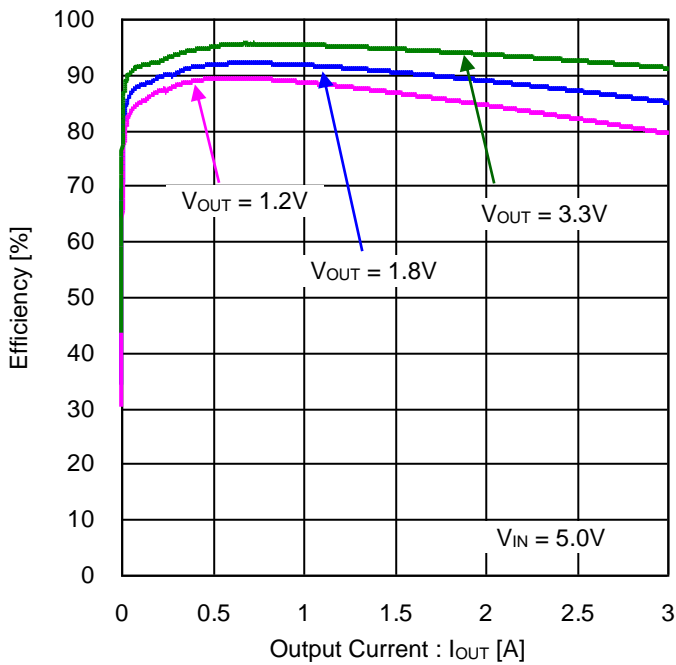

Figure 20. Efficiency vs Output Current
($V_{IN} = 5.0V$, $V_{MODE} = 5.0V$, $L = 1.5\mu H$)

Typical Performance Curves (Application) - continued

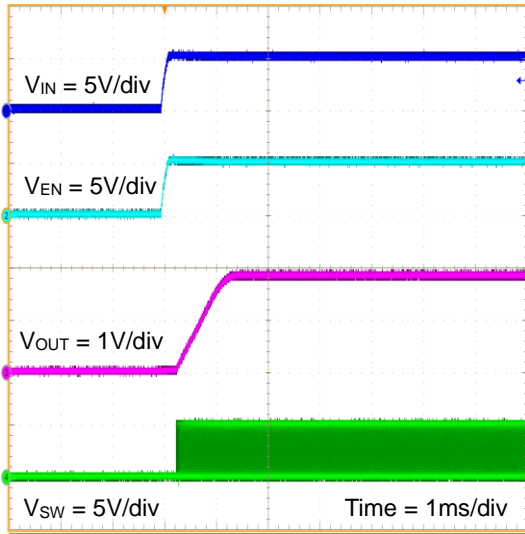

Figure 21. Start-up Waveform ($V_{IN} = V_{EN}$)
($V_{OUT} = 1.8V$, $V_{MODE} = V_{IN}$, $R_{LOAD} = 0.6\Omega$)

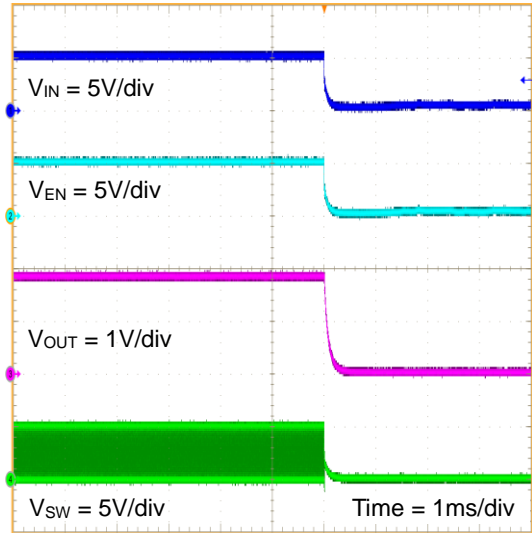

Figure 22. Shutdown Waveform ($V_{IN} = V_{EN}$)
($V_{OUT} = 1.8V$, $V_{MODE} = V_{IN}$, $R_{LOAD} = 0.6\Omega$)

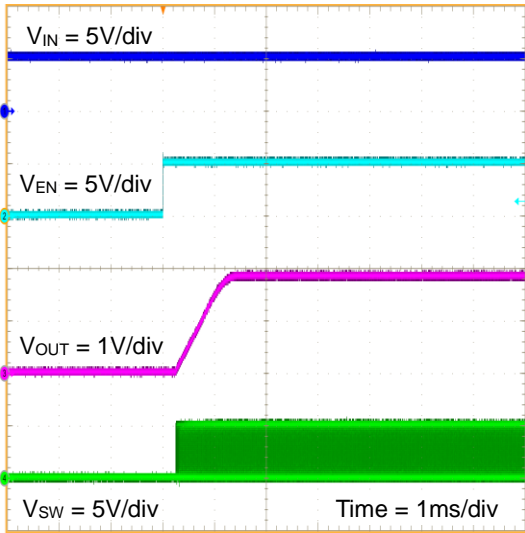

Figure 23. Start-up Waveform ($V_{EN} = 0V$ to $5V$)
($V_{OUT} = 1.8V$, $V_{MODE} = V_{IN}$, $R_{LOAD} = 0.6\Omega$)

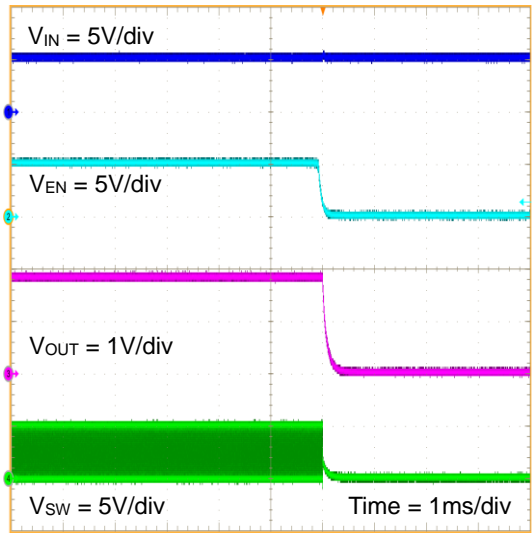

Figure 24. Shutdown Waveform ($V_{EN} = 5V$ to $0V$)
($V_{OUT} = 1.8V$, $V_{MODE} = V_{IN}$, $R_{LOAD} = 0.6\Omega$)

Typical Performance Curves (Application) - continued

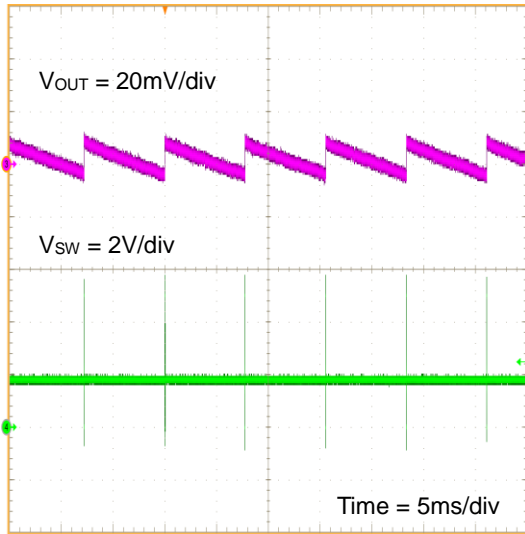

Figure 25. Output Voltage Ripple
 ($V_{IN} = 5V$, $V_{OUT} = 1.8V$, $V_{MODE} = V_{IN}$, $I_{OUT} = 0A$)

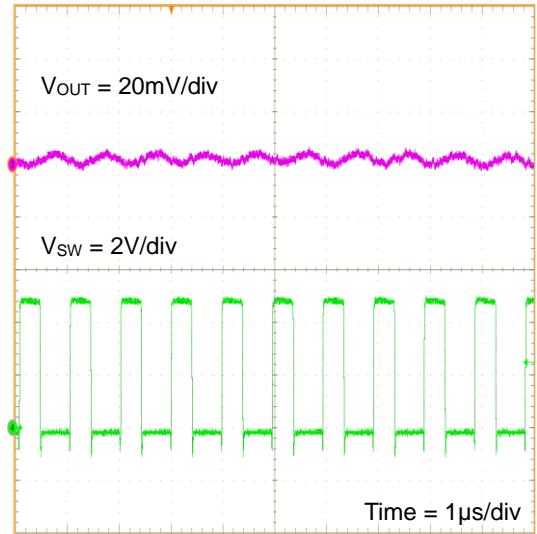

Figure 26. Output Voltage Ripple
 ($V_{IN} = 5V$, $V_{OUT} = 1.8V$, $V_{MODE} = V_{IN}$, $I_{OUT} = 3A$)

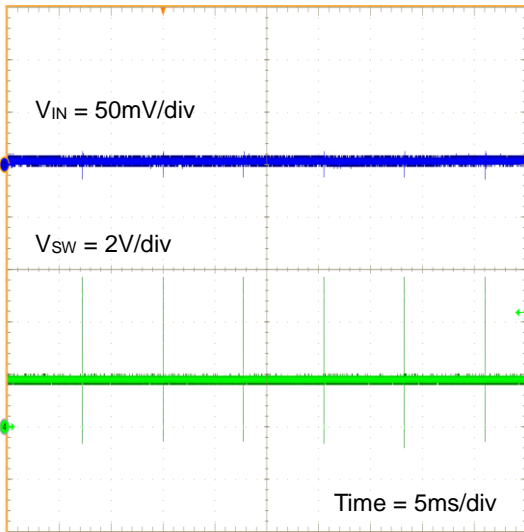

Figure 27. Input Voltage Ripple
 ($V_{IN} = 5V$, $V_{OUT} = 1.8V$, $V_{MODE} = V_{IN}$, $I_{OUT} = 0A$)

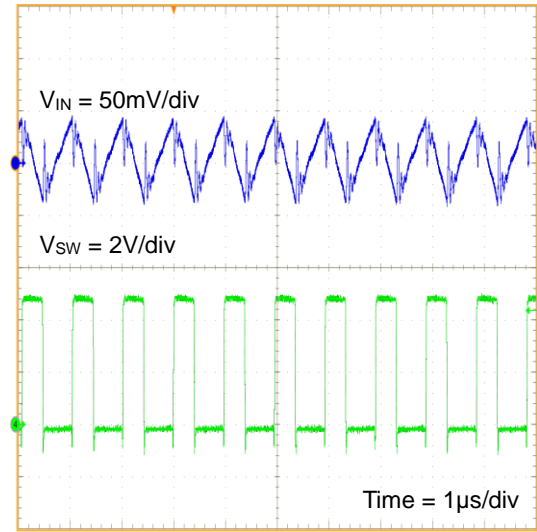

Figure 28. Input Voltage Ripple
 ($V_{IN} = 5V$, $V_{OUT} = 1.8V$, $V_{MODE} = V_{IN}$, $I_{OUT} = 3A$)

Typical Performance Curves (Application) - continued

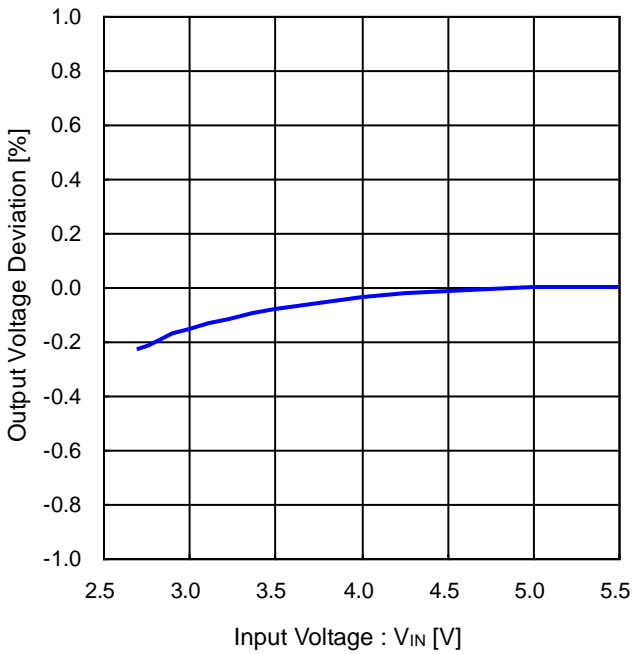

Figure 29. Line Regulation
($V_{OUT} = 1.8V$, $V_{MODE} = V_{IN}$, $I_{OUT}=3A$)

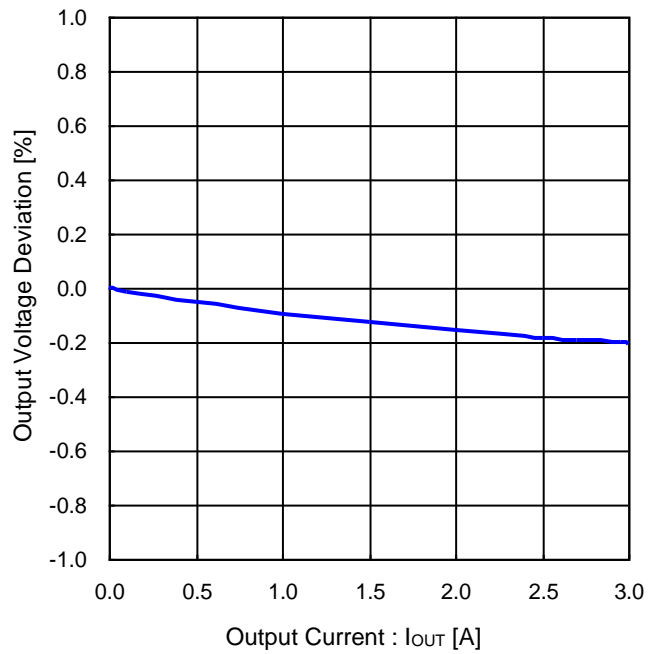

Figure 30. Load Regulation
($V_{IN} = 5V$, $V_{OUT} = 1.8V$, $V_{MODE} = V_{IN}$)

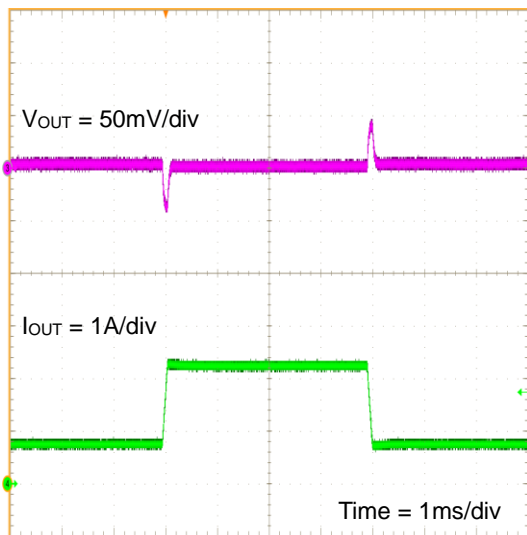

Figure 31. Load Transient Response
 $I_{OUT} = 0.75A - 2.25A$
($V_{IN} = 5V$, $V_{OUT} = 1.8V$, $V_{MODE} = V_{IN}$, $C_{OUT} = 22\mu F \times 2$)

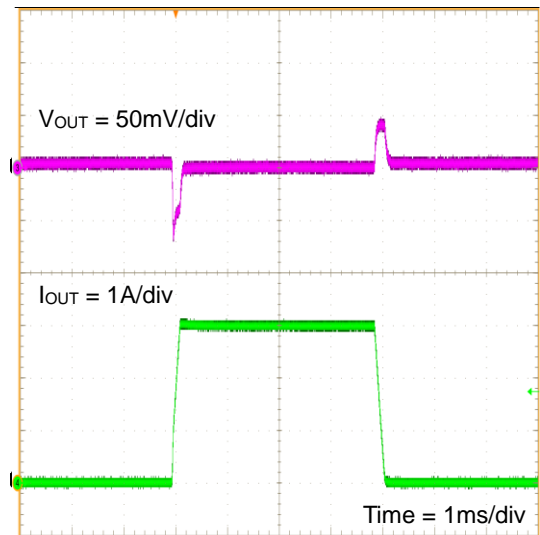

Figure 32. Load Transient Response
 $I_{OUT} = 0A - 3A$
($V_{IN} = 5V$, $V_{OUT} = 1.8V$, $V_{MODE} = V_{IN}$, $C_{OUT} = 22\mu F \times 2$)

Application Information

1. Function Explanations

(1) Basic Operation

(a) DC/DC Converter Operation

BD9A302QWZ is a synchronous rectifying buck DC/DC converter that achieves fast load transient response by employing current mode control system. It utilizes switching operation in PWM (Pulse Width Modulation) mode for heavy load, while it utilizes SLLM (Simple Light Load Mode) control for light load to improve efficiency.

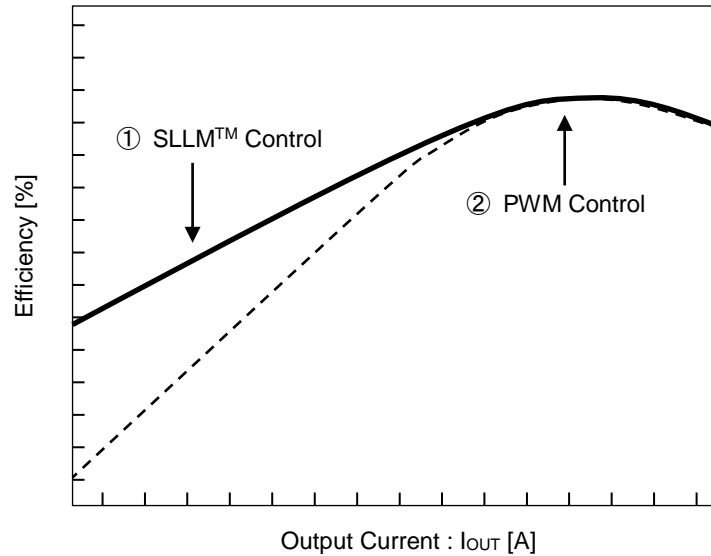

Figure 33. Efficiency (SLLM™ Control and PWM Control)

①SLLM™ Control

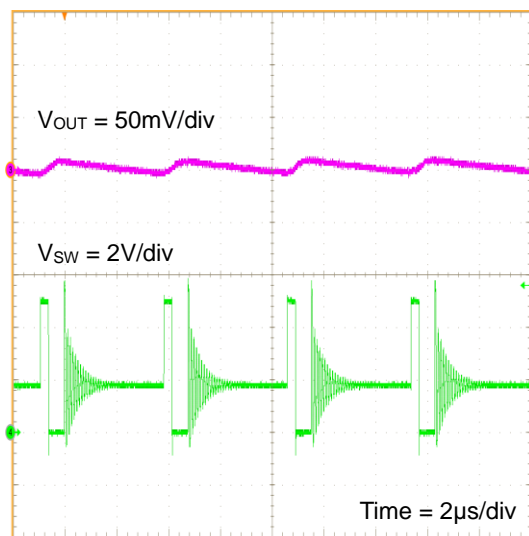

Figure 34. SW Waveform (SLLM™ Control)
(VIN = 5.0V, VOUT = 1.8V, VMODE = VIN, IOUT = 50mA)

②PWM Control

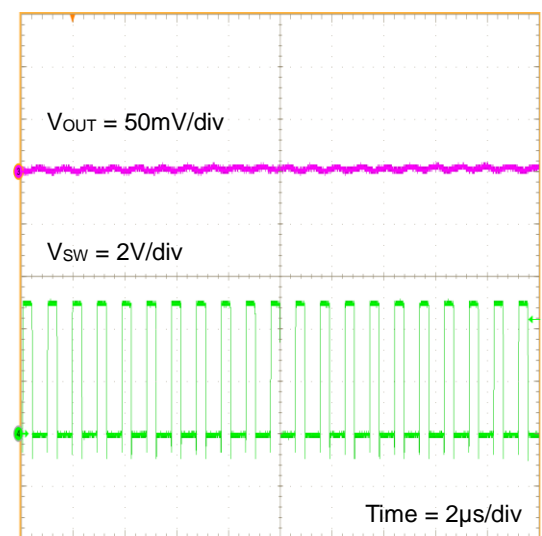

Figure 35. SW Waveform (PWM Control)
(VIN = 5.0V, VOUT = 1.8V, VMODE = VIN, IOUT = 1A)

(b) Enable Control

The IC shutdown can be controlled by the voltage applied to the EN terminal. When V_{EN} reaches 2.0V (Min), the internal circuit is activated and the IC starts up. To enable shutdown control with the EN terminal, the shutdown interval (low level interval of EN) must be set to 100 μ s or longer. Startup by EN must be at the same time or after the input of power supply voltage.

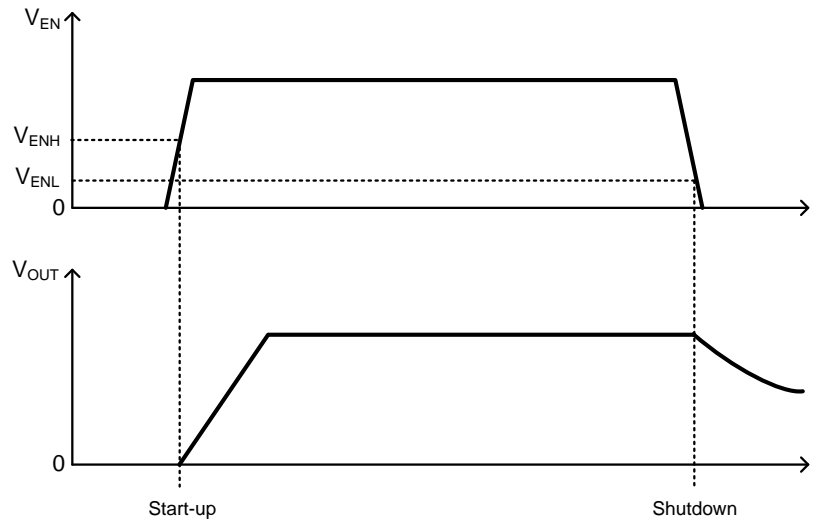

Figure 36. Start-up and Shutdown with Enable

(c) Soft Start

When EN terminal is switched High, Soft Start operates and the output voltage gradually rises. With the Soft Start Function, overshoot of output voltage and rush current can be prevented. The rising time of output voltage is 1ms (Typ).

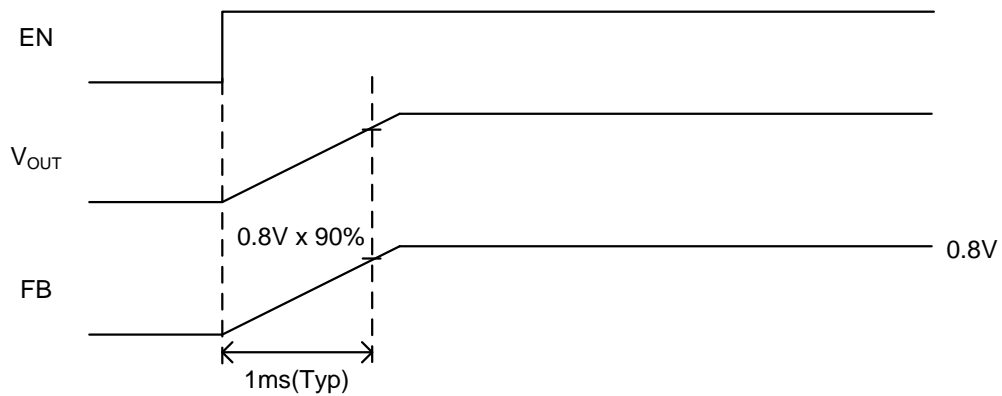

Figure 37. Soft Start Timing Chart

(2) Protection

The protective circuits are intended for prevention of damage caused by unexpected accidents. Do not use them for continuous protective operation.

(a) Short Circuit Protection (SCP)

The short circuit protection block compares the FB terminal voltage with the internal reference voltage V_{REF} . When the FB terminal voltage has fallen below 0.4V (Typ) for 1ms (Typ), SCP stops the operation for 16ms (Typ) and subsequently initiates a restart. However, during start-up, short circuit protection does not operate even if the IC is still in the SCP condition.

| EN Terminal | Start-up Condition | FB Terminal | Short Circuit Protection |
|----------------|--------------------|-------------------|--------------------------|
| 2.0V or higher | During start-up | $\leq 0.4V$ (Typ) | OFF |
| | | $> 0.4V$ (Typ) | OFF |
| | Completed start-up | $\leq 0.4V$ (Typ) | ON |
| | | $> 0.4V$ (Typ) | OFF |
| 0.8V or lower | - | - | OFF |

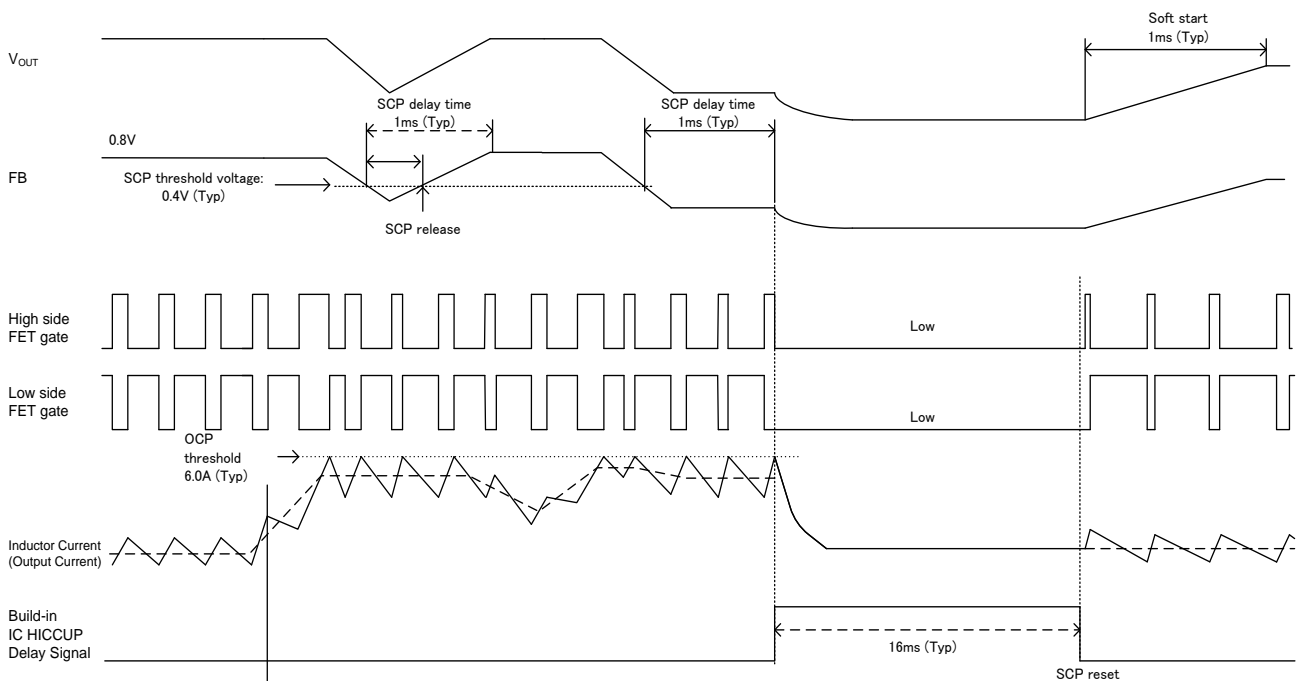

Figure 38. Short Circuit Protection (SCP) Timing Chart

(b) Under Voltage Lockout Protection (UVLO)

The Under Voltage Lockout Protection circuit monitors the VIN terminal voltage. The operation enters standby when the VIN terminal voltage is 2.45V (Typ) or lower. The operation starts when the VIN terminal voltage is 2.55V (Typ) or higher.

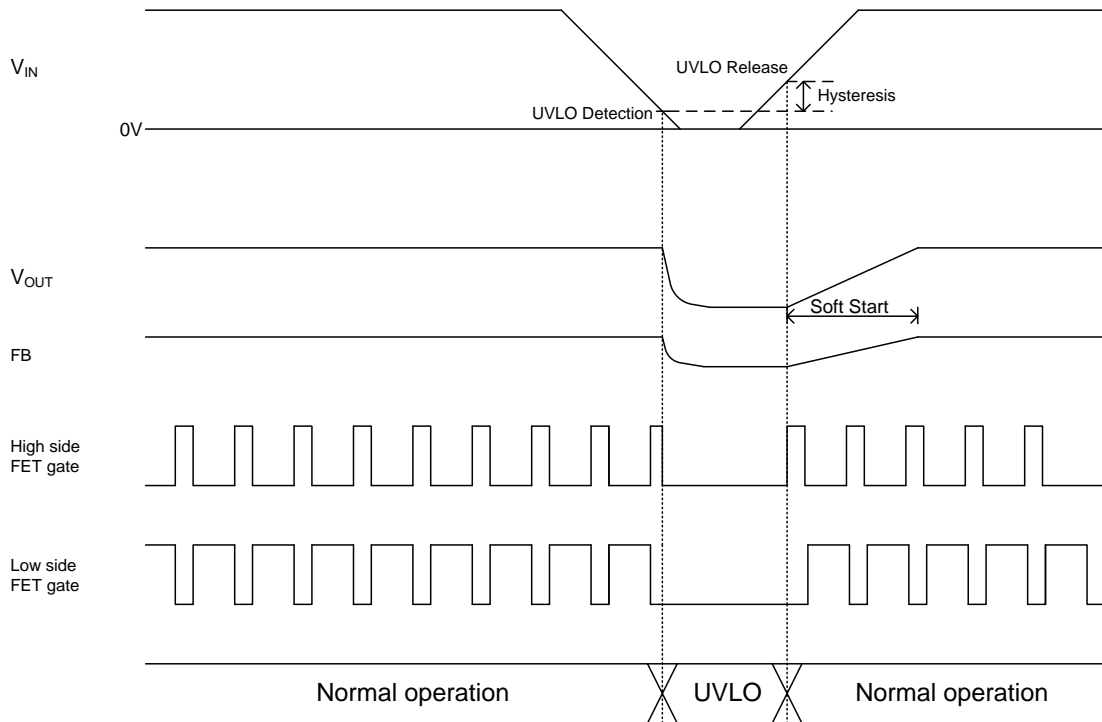

Figure 39. UVLO Timing Chart

(c) Thermal Shutdown (TSD)

When the chip temperature exceeds $T_j = 175^\circ\text{C}$ (Typ), the DC/DC converter output is stopped. Thermal protection circuit is reset when the temperature falls down. The thermal shutdown circuit is intended for shutting down the IC from thermal runaway in an abnormal state with the temperature exceeding $T_{j\text{max}} = 150^\circ\text{C}$. It is not meant to protect or guarantee the reliability of the application. Do not use this function of the circuit for application protection design.

(d) Over Current Protection (OCP)

The Over Current Protection function operates by using the current mode control to limit the current that flows through the high-side MOSFET at each cycle of the switching frequency. The designed over current limit value is 6.0A (Typ).

(e) Over Voltage Protection (OVP)

The over voltage protection function (OVP) compares the FB terminal voltage with the internal reference voltage V_{REF} . When the FB terminal voltage exceeds 0.88V (Typ), it turns the output MOSFETs off. The output voltage returns to normal operation level with hysteresis after the output voltage drops.

2. Application Example ($V_{OUT}=3.3V$)

| Parameter | Symbol | Value |
|-----------------------------|--------------|----------------|
| Input Voltage | V_{IN} | 5V |
| Output Voltage | V_{OUT} | 3.3V |
| Switching Frequency | f_{osc} | 1MHz (Typ) |
| Maximum Output Current | I_{OUTMAX} | 3A |
| Operating Temperature Range | T_{opr} | -40°C to +85°C |

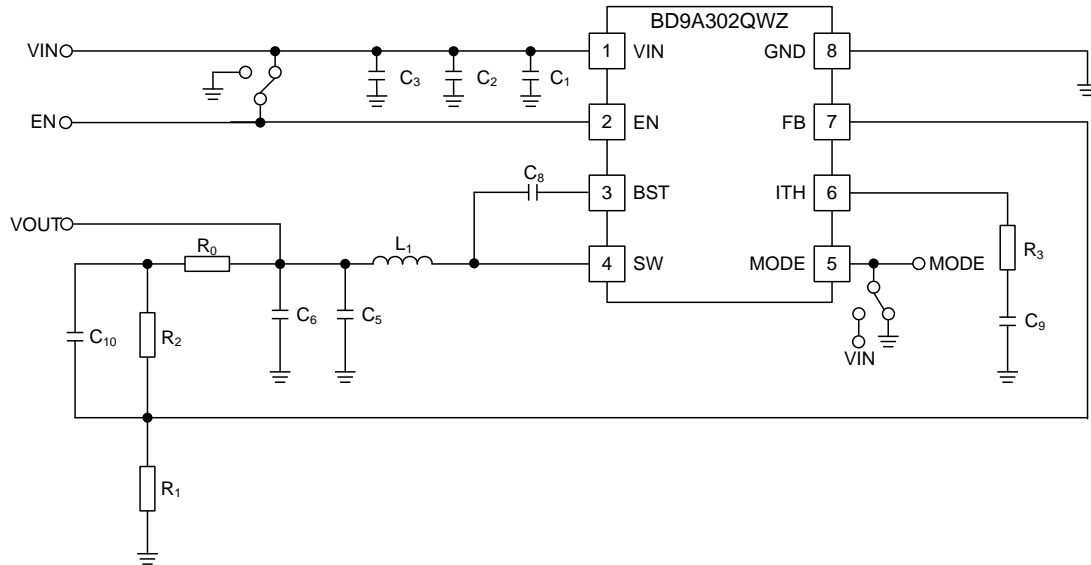

Figure 40. Application Circuit

Table 1. Recommended Component Values

| Part No. | Value | Company | Part Name |
|----------------|--------------|---------|-------------------|
| L_1 | 1.5 μ H | Murata | FDSD0420-H-1R5M |
| C_1 (Note 1) | 0.1 μ F | Murata | GRM155B11A104MA01 |
| C_2 (Note 2) | 10 μ F | Murata | GRM21BB31A106ME18 |
| C_3 | - | - | - |
| C_5 (Note 3) | 22 μ F | Murata | GRM21BB30J226ME38 |
| C_6 (Note 3) | 22 μ F | Murata | GRM21BB30J226ME38 |
| C_8 (Note 4) | 0.1 μ F | Murata | GRM155B11A104MA01 |
| C_9 | 2700pF | Murata | GRM155B11H272KA01 |
| C_{10} | - | - | - |
| R_0 | 0 Ω | ROHM | MCR01MZPJ000 |
| R_1 | 24k Ω | ROHM | MCR01MZPD2402 |
| R_2 | 75k Ω | ROHM | MCR01MZPD7502 |
| R_3 | 18k Ω | ROHM | MCR01MZPD1802 |

(Note 1) In order to reduce the influence of high frequency noise, mount the 0.1 μ F ceramic capacitor as close as possible to the VIN pin and GND pin.

(Note 2) For the capacitance of input capacitor, take temperature characteristics, DC bias characteristics, etc. into consideration to set to a minimum value of no less than 4.7 μ F.

(Note 3) In case capacitance value fluctuates due to temperature characteristics, DC bias characteristics, etc. of output capacitor, loop response characteristics may change. Please confirm on actual equipment. When selecting a capacitor, confirm the characteristics of the capacitor in its datasheet. Ceramic type of capacitors is recommended for the output capacitors.

(Note 4) For capacitance of bootstrap capacitor take temperature characteristics, DC bias characteristics, etc. into consideration to set minimum value to no less than 0.047 μ F.

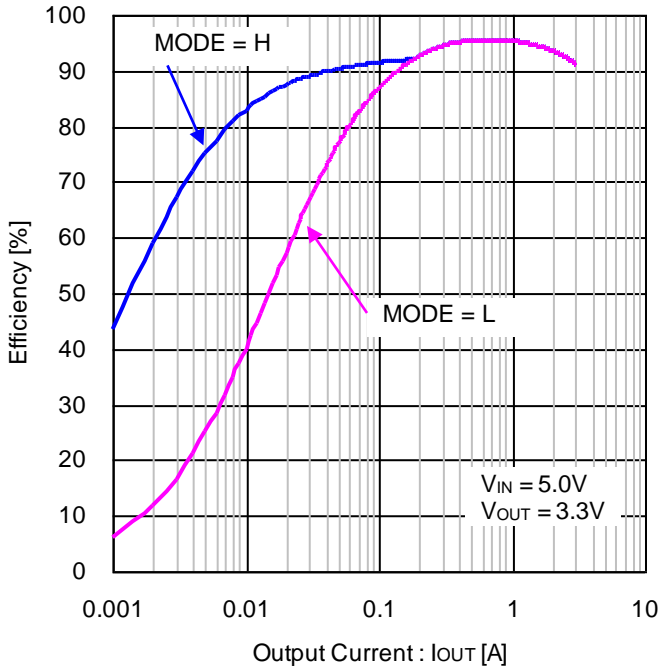

Figure 41. Efficiency vs Output Current
($V_{IN} = 5V$, $V_{OUT} = 3.3V$, $L = 1.5\mu H$)

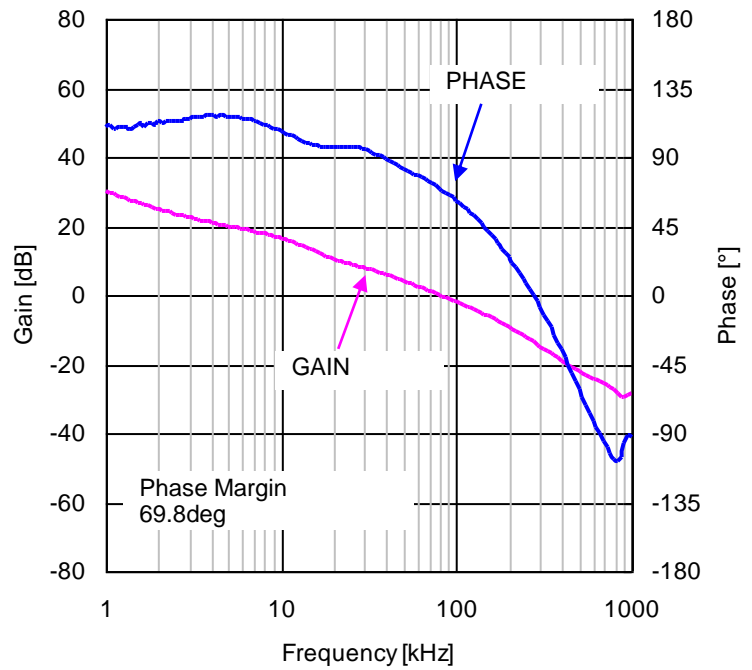

Figure 42. Closed Loop Response $I_{OUT} = 1A$
($V_{IN} = 5V$, $V_{OUT} = 3.3V$, $L = 1.5\mu H$, $C_{OUT} = 22\mu F \times 2$)

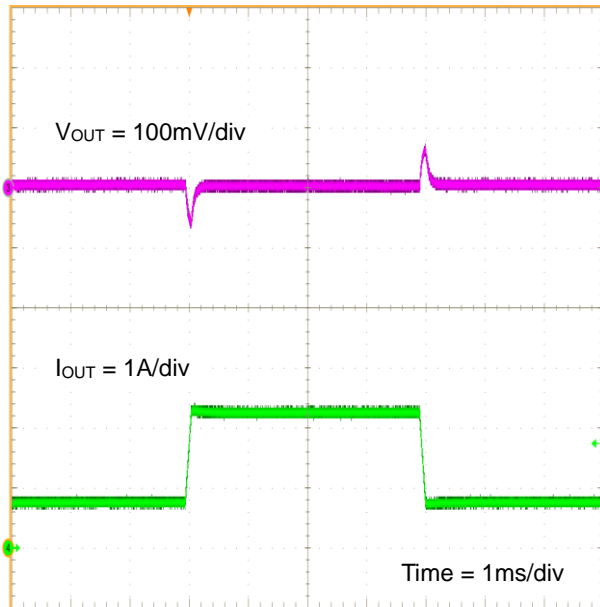

Figure 43. Load Transient Response
 $I_{OUT} = 0.75A - 2.25A$
($V_{IN} = 5V$, $V_{OUT} = 3.3V$, $L = 1.5\mu H$, $C_{OUT} = 22\mu F \times 2$)

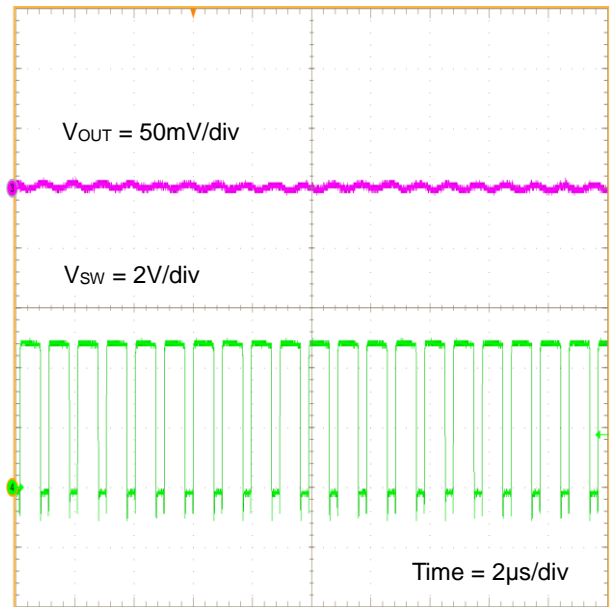

Figure 44. V_{OUT} Ripple $I_{OUT} = 3A$
($V_{IN} = 5V$, $V_{OUT} = 3.3V$, $L = 1.5\mu H$, $C_{OUT} = 22\mu F \times 2$)

3. Application Example ($V_{OUT}=1.8V$)

| Parameter | Symbol | Value |
|-----------------------------|--------------|----------------|
| Input Voltage | V_{IN} | 5V |
| Output Voltage | V_{OUT} | 1.8V |
| Switching Frequency | f_{osc} | 1MHz (Typ) |
| Maximum Output Current | I_{OUTMAX} | 3A |
| Operating Temperature Range | T_{opr} | -40°C to +85°C |

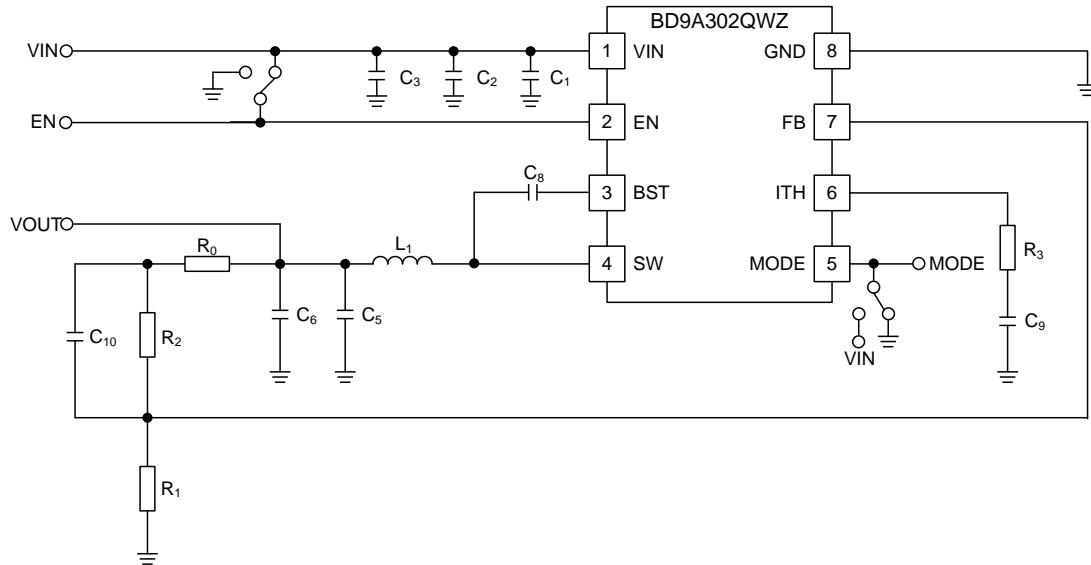

Figure 45. Application Circuit

Table 2. Recommended Component Values

| Part No. | Value | Company | Part Name |
|----------------|---------------|---------|-------------------|
| L_1 | 1.5 μ H | Murata | FDSD0420-H-1R5M |
| C_1 (Note 1) | 0.1 μ F | Murata | GRM155B11A104MA01 |
| C_2 (Note 2) | 10 μ F | Murata | GRM21BB31A106ME18 |
| C_3 | - | - | - |
| C_5 (Note 3) | 22 μ F | Murata | GRM21BB30J226ME38 |
| C_6 (Note 3) | 22 μ F | Murata | GRM21BB30J226ME38 |
| C_8 (Note 4) | 0.1 μ F | Murata | GRM155B11A104MA01 |
| C_9 | 2700pF | Murata | GRM155B11H272KA01 |
| C_{10} | - | - | - |
| R_0 | 0 Ω | ROHM | MCR01MZPJ000 |
| R_1 | 24k Ω | ROHM | MCR01MZPD2402 |
| R_2 | 30k Ω | ROHM | MCR01MZPD3002 |
| R_3 | 9.1k Ω | ROHM | MCR01MZPD9101 |

- (Note 1) In order to reduce the influence of high frequency noise, mount the 0.1 μ F ceramic capacitor as close as possible to the VIN pin and GND pin.
- (Note 2) For the capacitance of input capacitor, take temperature characteristics, DC bias characteristics, etc. into consideration to set to a minimum value of no less than 4.7 μ F.
- (Note 3) In case capacitance value fluctuates due to temperature characteristics, DC bias characteristics, etc. of output capacitor, loop response characteristics may change. Please confirm on actual equipment. When selecting a capacitor, confirm the characteristics of the capacitor in its datasheet. Ceramic type of capacitors is recommended for the output capacitors.
- (Note 4) For capacitance of bootstrap capacitor take temperature characteristics, DC bias characteristics, etc. into consideration to set minimum value to no less than 0.047 μ F.

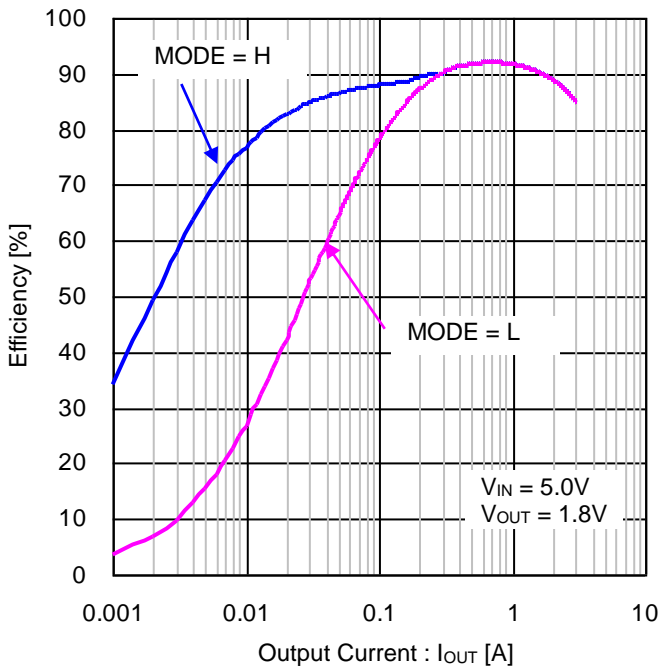

Figure 46. Efficiency vs Output Current
($V_{IN} = 5V$, $V_{OUT} = 1.8V$, $L = 1.5\mu H$)

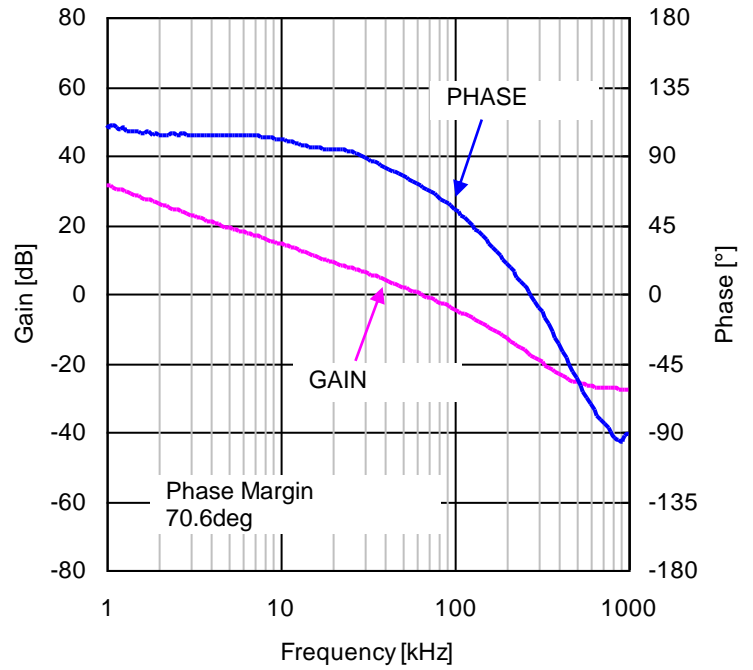

Figure 47. Closed Loop Response $I_{OUT} = 1A$
($V_{IN} = 5V$, $V_{OUT} = 1.8V$, $L = 1.5\mu H$, $C_{OUT} = 22\mu F \times 2$)

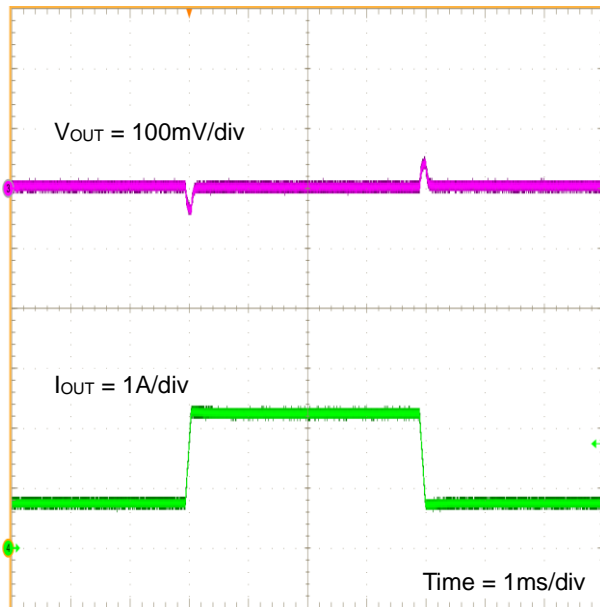

Figure 48. Load Transient Response
 $I_{OUT} = 0.75A - 2.25A$
($V_{IN} = 5V$, $V_{OUT} = 1.8V$, $L = 1.5\mu H$, $C_{OUT} = 22\mu F \times 2$)

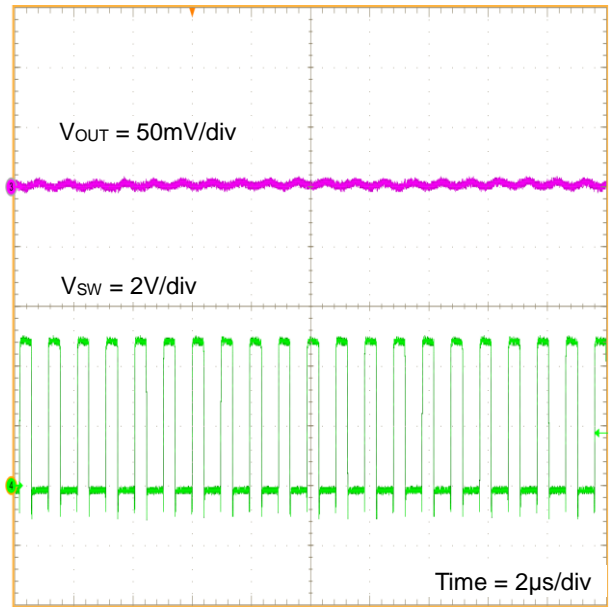

Figure 49. V_{OUT} Ripple $I_{OUT} = 3A$
($V_{IN} = 5V$, $V_{OUT} = 1.8V$, $L = 1.5\mu H$, $C_{OUT} = 22\mu F \times 2$)

4. Application Example (V_{OUT}=1.5V)

| Parameter | Symbol | Value |
|-----------------------------|---------------------|----------------|
| Input Voltage | V _{IN} | 5V |
| Output Voltage | V _{OUT} | 1.5V |
| Switching Frequency | f _{osc} | 1MHz (Typ) |
| Maximum Output Current | I _{OUTMAX} | 3A |
| Operating Temperature Range | T _{opr} | -40°C to +85°C |

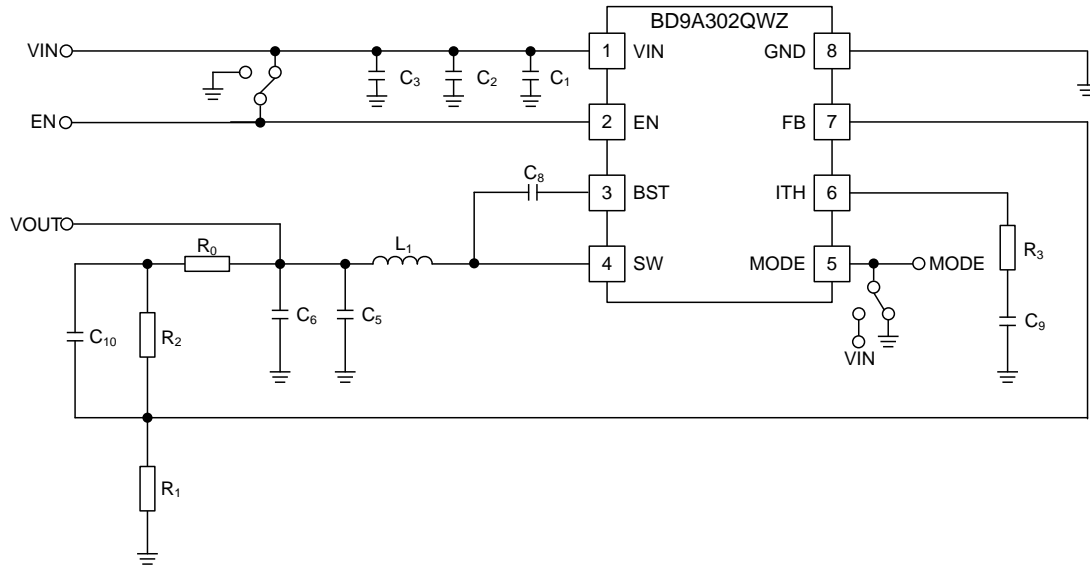

Figure 50. Application Circuit

Table 3. Recommended Component Values

| Part No. | Value | Company | Part Name |
|-------------------------|--------|---------|-------------------|
| L ₁ | 1.5μH | Murata | FDSD0420-H-1R5M |
| C ₁ (Note 1) | 0.1μF | Murata | GRM155B11A104MA01 |
| C ₂ (Note 2) | 10μF | Murata | GRM21BB31A106ME18 |
| C ₃ | - | - | - |
| C ₅ (Note 3) | 22μF | Murata | GRM21BB30J226ME38 |
| C ₆ (Note 3) | 22μF | Murata | GRM21BB30J226ME38 |
| C ₈ (Note 4) | 0.1μF | Murata | GRM155B11A104MA01 |
| C ₉ | 2700pF | Murata | GRM155B11H272KA01 |
| C ₁₀ | - | - | - |
| R ₀ | 0Ω | ROHM | MCR01MZPJ000 |
| R ₁ | 18kΩ | ROHM | MCR01MZPD1802 |
| R ₂ | 16kΩ | ROHM | MCR01MZPD1602 |
| R ₃ | 9.1kΩ | ROHM | MCR01MZPD9101 |

(Note 1) In order to reduce the influence of high frequency noise, mount the 0.1μF ceramic capacitor as close as possible to the VIN pin and GND pin.
 (Note 2) For the capacitance of input capacitor, take temperature characteristics, DC bias characteristics, etc. into consideration to set to a minimum value of no less than 4.7μF.
 (Note 3) In case capacitance value fluctuates due to temperature characteristics, DC bias characteristics, etc. of output capacitor, loop response characteristics may change. Please confirm on actual equipment. When selecting a capacitor, confirm the characteristics of the capacitor in its datasheet. Ceramic type of capacitors is recommended for the output capacitors.
 (Note 4) For capacitance of bootstrap capacitor take temperature characteristics, DC bias characteristics, etc. into consideration to set minimum value to no less than 0.047μF.

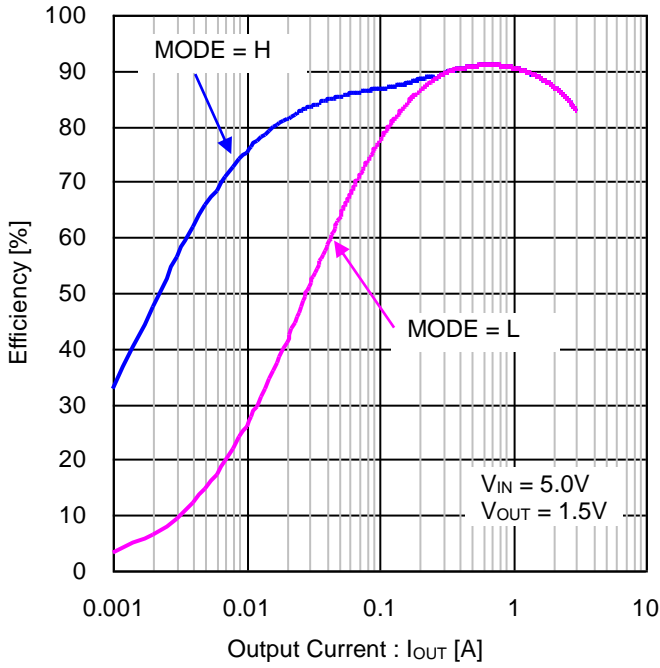

Figure 51. Efficiency vs Output Current
($V_{IN} = 5V$, $V_{OUT} = 1.5V$, $L = 1.5\mu H$)

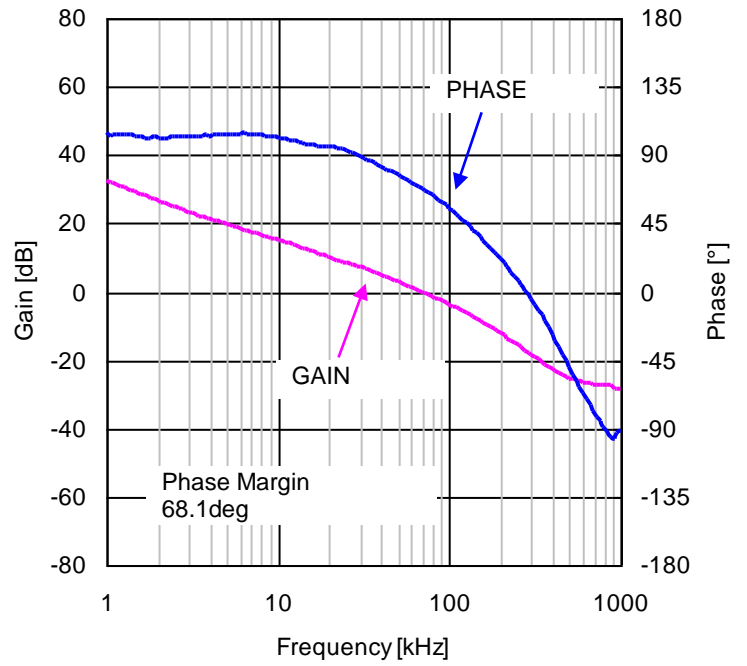

Figure 52. Closed Loop Response $I_{OUT} = 1A$
($V_{IN} = 5V$, $V_{OUT} = 1.5V$, $L = 1.5\mu H$, $C_{OUT} = 22\mu F \times 2$)

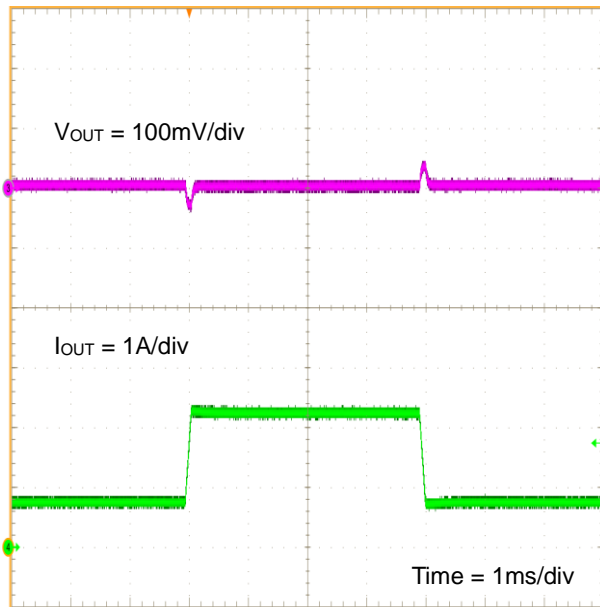

Figure 53. Load Transient Response
 $I_{OUT} = 0.75A - 2.25A$
($V_{IN} = 5V$, $V_{OUT} = 1.5V$, $L = 1.5\mu H$, $C_{OUT} = 22\mu F \times 2$)

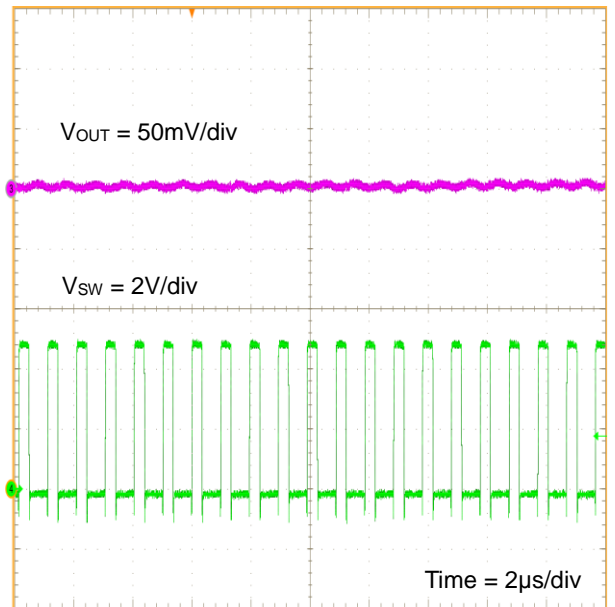

Figure 54. V_{OUT} Ripple $I_{OUT} = 3A$
($V_{IN} = 5V$, $V_{OUT} = 1.5V$, $L = 1.5\mu H$, $C_{OUT} = 22\mu F \times 2$)

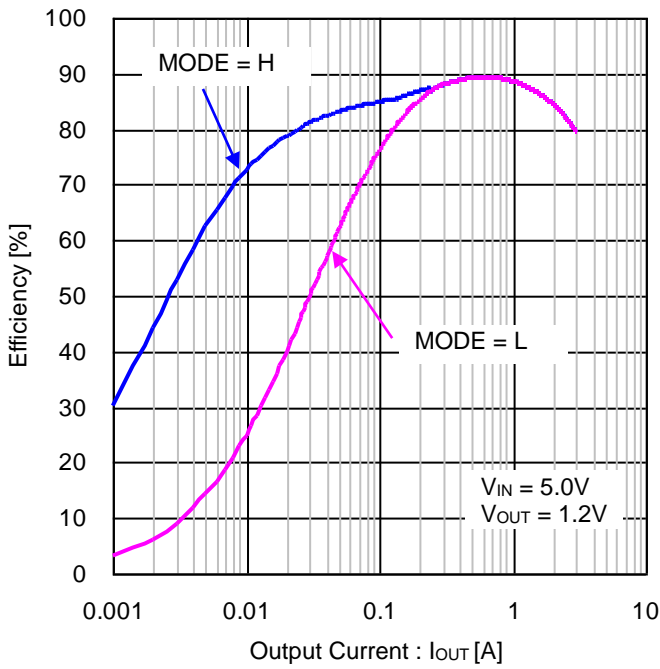

Figure 56. Efficiency vs Output Current
($V_{IN} = 5V$, $V_{OUT} = 1.2V$, $L = 1.5\mu H$)

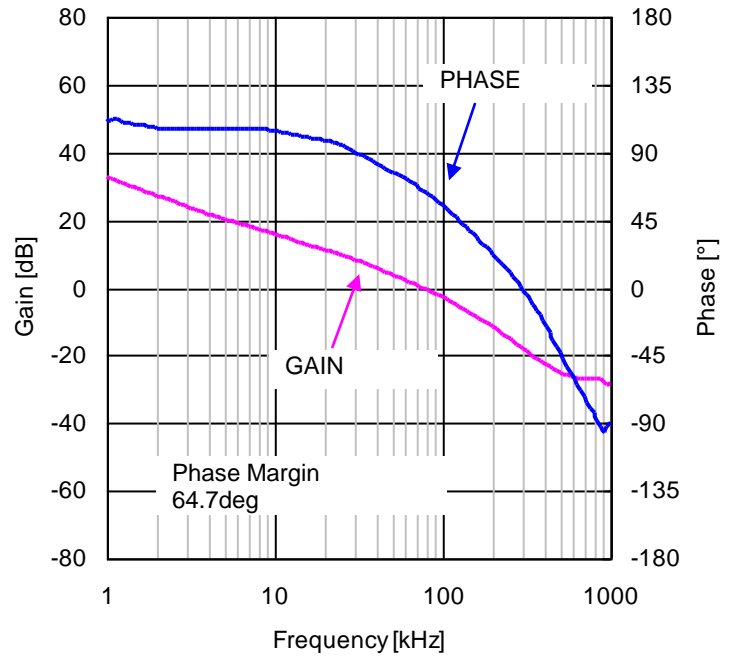

Figure 57. Closed Loop Response $I_{OUT} = 1A$
($V_{IN} = 5V$, $V_{OUT} = 1.2V$, $L = 1.5\mu H$, $C_{OUT} = 22\mu F \times 2$)

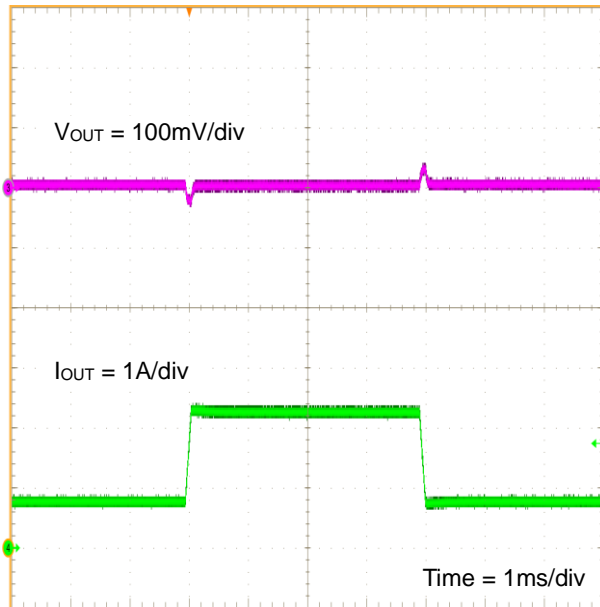

Figure 58. Load Transient Response
 $I_{OUT} = 0.75A - 2.25A$
($V_{IN} = 5V$, $V_{OUT} = 1.2V$, $L = 1.5\mu H$, $C_{OUT} = 22\mu F \times 2$)

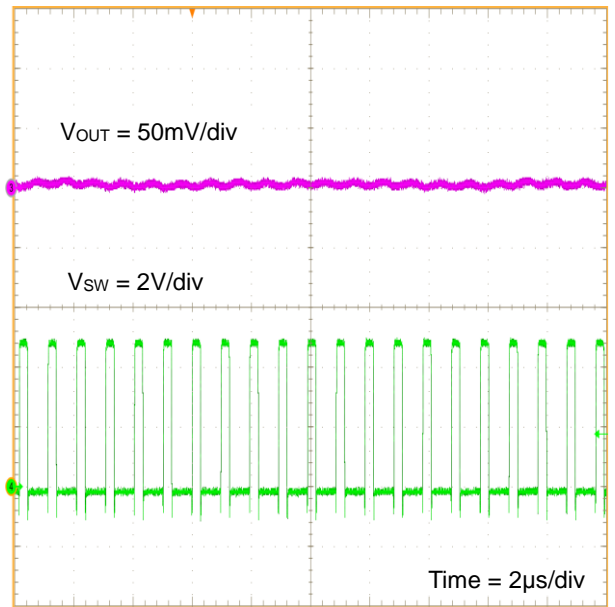

Figure 59. V_{OUT} Ripple $I_{OUT} = 3A$
($V_{IN} = 5V$, $V_{OUT} = 1.2V$, $L = 1.5\mu H$, $C_{OUT} = 22\mu F \times 2$)

6. Selection of Components Externally Connected

About the application except the recommendation, please contact us.

(1) Output LC Filter Constant

The DC/DC converter requires an LC filter for smoothing the output voltage in order to supply a continuous current to the load. ΔI_L ripple current flowing through the inductor is returned to the BD9A302QWZ for SLLM™ control. It is recommended to use 1.5 μ H inductor since the feedback current has the best behavior in the specified inductance value.

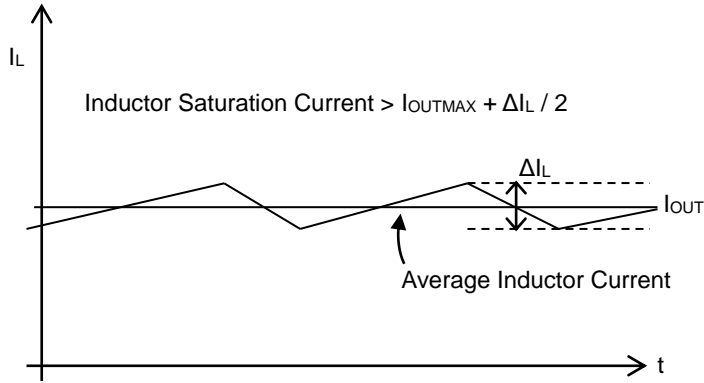

Figure 60. Waveform of Inductor Current

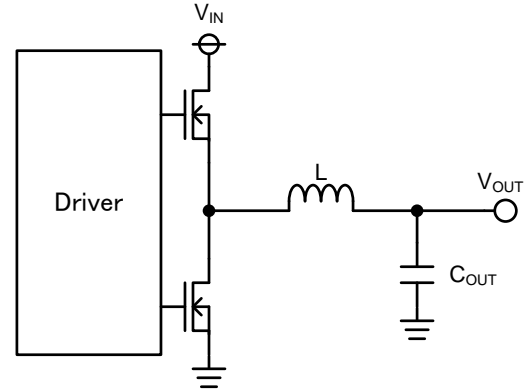

Figure 61. Output LC Filter Circuit

Calculation with $V_{IN} = 5V$, $V_{OUT} = 1.8V$, $L = 1.5\mu H$, and switching frequency $f_{OSC} = 1MHz$ is expressed as below.

Inductor ripple current ΔI_L

$$\Delta I_L = V_{OUT} \times (V_{IN} - V_{OUT}) \times \frac{1}{V_{IN} \times f_{OSC} \times L} = 768 \text{ [mA]}$$

The saturation current of the inductor must be larger than the sum of the maximum output current and one-half (1/2) of the inductor ripple current ΔI_L .

The output capacitor C_{OUT} affects the output ripple voltage characteristics. The output capacitor C_{OUT} must satisfy the required ripple voltage characteristics.

The output ripple voltage can be represented by the following equation.

$$\Delta V_{RPL} = \Delta I_L \times \left(R_{ESR} + \frac{1}{8 \times C_{OUT} \times f_{OSC}} \right) \text{ [V]}$$

R_{ESR} is the Equivalent Series Resistance (ESR) of the output capacitor.

Be careful of the total capacitance value, when additional capacitor C_{LOAD} is connected to the output capacitor C_{OUT} . Use maximum additional capacitor C_{LOAD} (Max) condition which satisfies the following method.

$$\text{Maximum starting inductor ripple current } I_{LSTART} < \text{Over Current limit } 3.8A \text{ (Min)}$$

Maximum starting inductor ripple current I_{LSTART} can be expressed in the following method.

$$I_{LSTART} = \text{Maximum starting output current}(I_{OUTMAX}) + \text{Charge current to output capacitor}(I_{CAP}) + \frac{\Delta I_L}{2}$$

Charge current of the output capacitor I_{CAP} can be expressed in the following method.

$$I_{CAP} = \frac{(C_{OUT} + C_{LOAD}) \times V_{OUT}}{t_{SS}} [A]$$

Calculation with $V_{IN} = 5V$, $V_{OUT} = 3.3V$, $L = 1.5\mu H$, switching frequency $f_{OSC} = 800kHz$ (Min), output capacitor $C_{OUT} = 44\mu F$, Soft Start time $t_{SS} = 0.5ms$ (Min), load current during soft start $I_{OSS} = 2A$ is expressed as below.

$$C_{LOAD}(Max) < \frac{(3.8 - I_{OSS} - \Delta I_L/2) \times t_{SS}}{V_{OUT}} - C_{OUT} = 157.9 [\mu F]$$

(Note) C_{LOAD} has an effect on the stability of the DC/DC converter.
To ensure the stability of the DC/DC converter, make sure that a sufficient phase margin is provided.

(2) Output Voltage Setting

The output voltage value is set by the feedback resistance ratio.

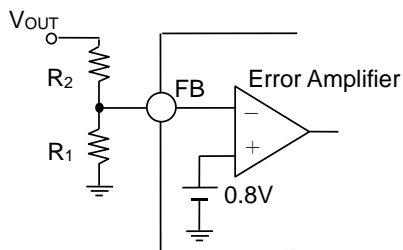

$$V_{OUT} = \frac{R1 + R2}{R1} \times 0.8 [V]$$

Figure 62. Feedback Resistors

(3) Phase Compensation Component

A current mode control buck DC/DC converter is a one-pole, one-zero system. One-pole is formed by an error amplifier and load and the one-zero point is added by phase compensation. The phase compensation resistor R_{ITH} determines the crossover frequency f_{CRS} where the total loop gain of the DC/DC converter is 0dB. A high value crossover frequency f_{CRS} provides a good load transient response characteristic but inferior stability. Conversely, a low value crossover frequency f_{CRS} greatly stabilizes the characteristics but the load transient response characteristic is impaired.

(a) Selection of Phase Compensation Resistor R_{ITH}

The Phase Compensation Resistance R_{ITH} can be determined by using the following equation.

$$R_{ITH} = \frac{2\pi \times V_{OUT} \times f_{CRS} \times C_{OUT}}{V_{FB} \times G_{MP} \times G_{MA}} \quad [\Omega]$$

Where:

V_{OUT} is the output voltage [V]

f_{CRS} is the crossover frequency [Hz]

C_{OUT} is the output capacitance [F]

V_{FB} is the feedback reference voltage (0.8V (Typ))

G_{MP} is the current sense gain (13A/V (Typ))

G_{MA} is the error amplifier transconductance (260 μ A/V (Typ))

(b) Selection of Phase Compensation Capacitance C_{ITH}

For stable operation of the DC/DC converter, zero for compensation cancels the phase delay due to the pole formed by the load.

The phase compensation capacitance C_{ITH} can be determined by using the following equation.

$$C_{ITH} = \frac{C_{OUT} \times V_{OUT}}{R_{ITH} \times I_{OUT}} \quad [F]$$

(c) Loop Stability

To ensure the stability of the DC/DC converter, make sure that a sufficient phase margin is provided. A phase margin of at least 45° in the worst conditions is recommended.

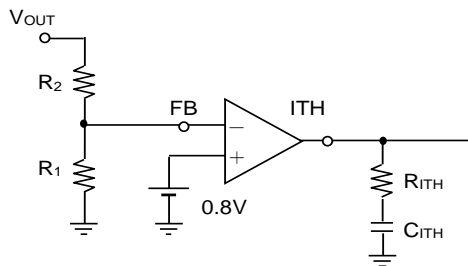

Figure 63. Phase Compensation Circuit

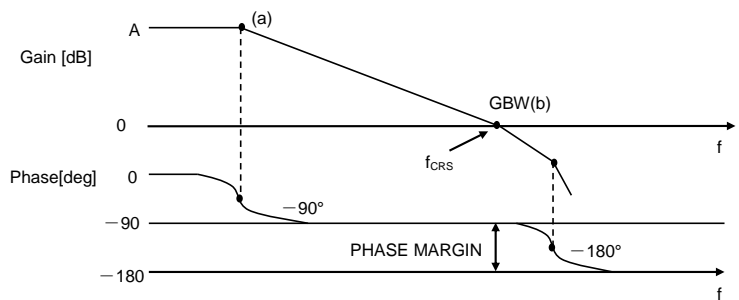

Figure 64. Bode Plot

7. PCB Layout Design

Figure 65 shows a buck DC/DC converter with a large pulsing current flowing into two loops. The first loop is the current flows to the converter when the high-side FET is turned on. The flow starts from the input capacitor C_{IN} , runs through the FET, inductor L and the output capacitor C_{OUT} , back to GND of C_{IN} via GND of C_{OUT} . The second loop is the current flows when the low-side FET is turned on. The flow starts from the low-side FET, runs through the inductor L and output capacitor C_{OUT} , back to GND of the low-side FET via GND of C_{OUT} . Route these two loops as thick and as short as possible to reduce noise for improved efficiency. It is recommended to connect the input and output capacitors directly to the GND plane. The PCB layout has a great influence on the DC/DC converter in terms of the overall heat generation, noise and efficiency characteristics.

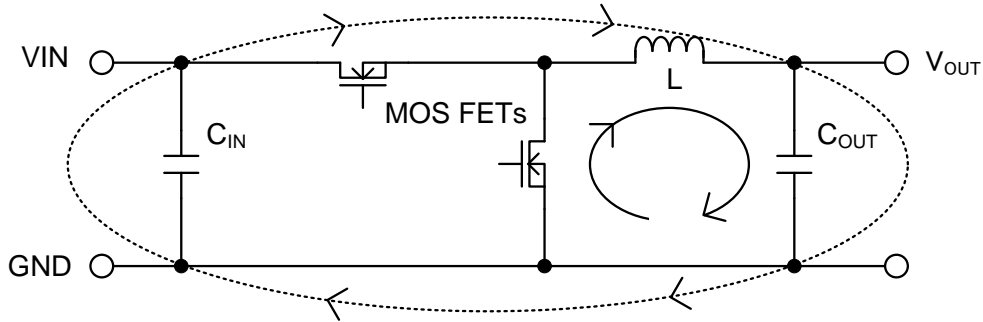

Figure 65. Current Loop of Buck DC/DC Converter

Accordingly, design the PCB layout considering the following points:

- (1) Connect an input capacitor as close as possible to the IC VIN terminal and GND terminal on the same plane as the IC.
- (2) If there is any unused area on the PCB, provide a copper foil plane for the GND node to assist heat dissipation from the IC and the surrounding components.
- (3) Switching nodes such as SW are susceptible to noise due to AC coupling with the other nodes. Route the inductor pattern as thick and as short as possible.
- (4) Provide lines connected to FB and ITH terminal with considerable distance from the SW nodes.
- (5) Place the output capacitor away from the input capacitor to avoid the propagation of harmonic noise from the input.

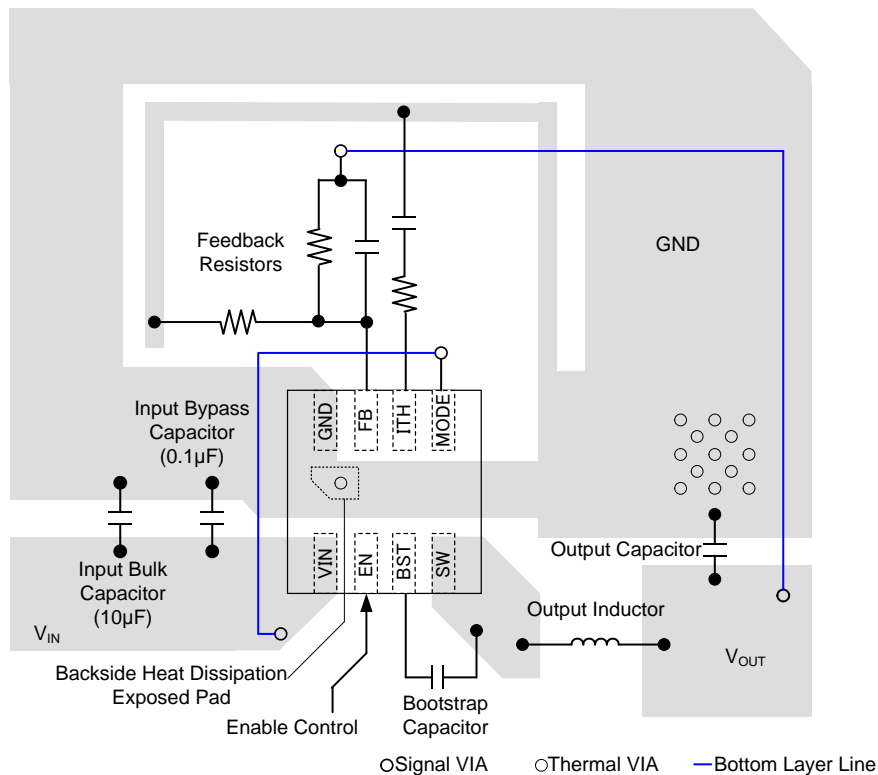
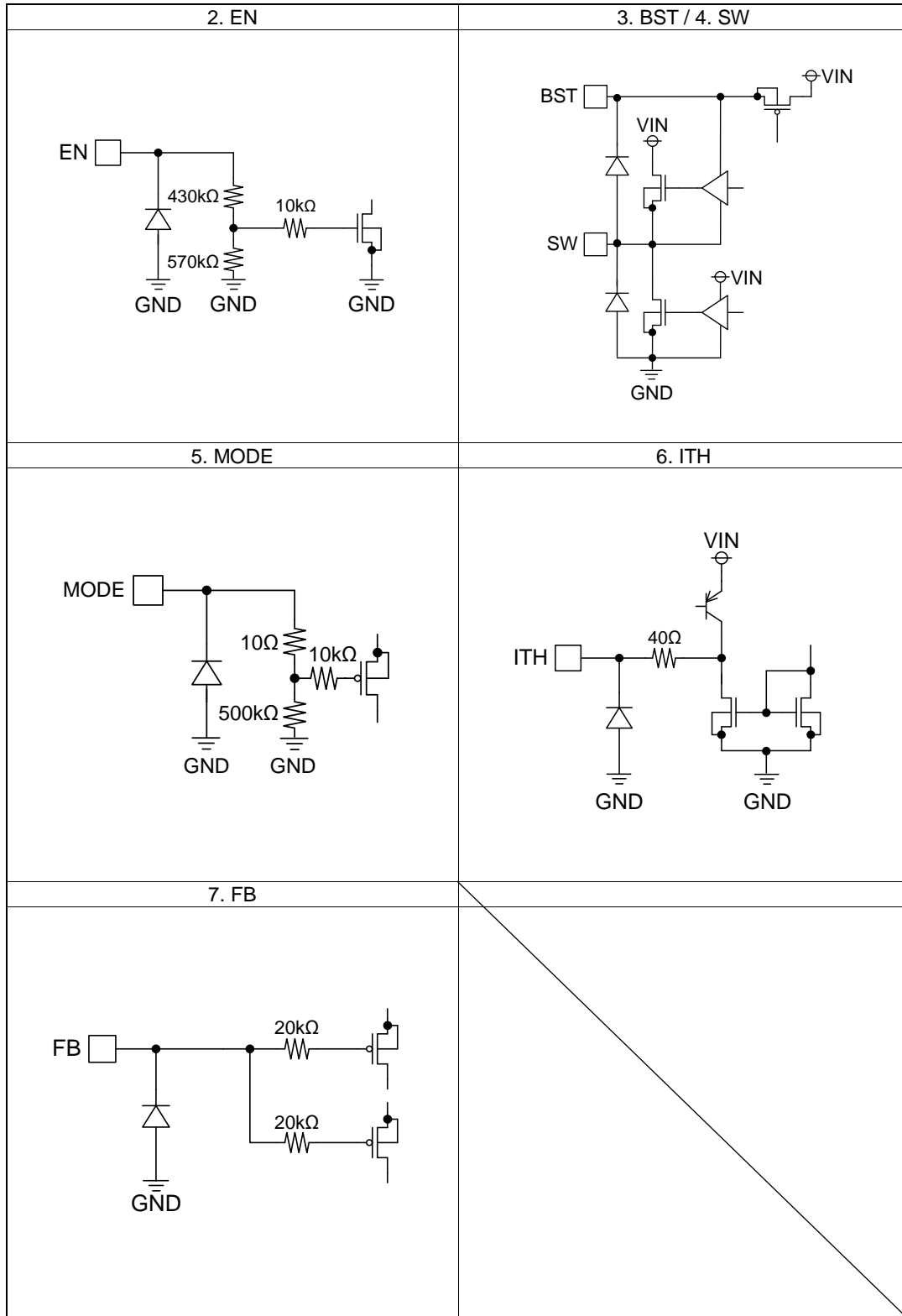

Figure 66. PCB Layout (MODE = H)

I/O Equivalence Circuits



Operational Notes

1. Reverse Connection of Power Supply

Connecting the power supply in reverse polarity can damage the IC. Take precautions against reverse polarity when connecting the power supply, such as mounting an external diode between the power supply and the IC's power supply pins.

2. Power Supply Lines

Design the PCB layout pattern to provide low impedance supply lines. Separate the ground and supply lines of the digital and analog blocks to prevent noise in the ground and supply lines of the digital block from affecting the analog block. Furthermore, connect a capacitor to ground at all power supply pins. Consider the effect of temperature and aging on the capacitance value when using electrolytic capacitors.

3. Ground Voltage

Ensure that no pins are at a voltage below that of the ground pin at any time, even during transient condition. However, pins that drive inductive loads (e.g. motor driver outputs, DC-DC converter outputs) may inevitably go below ground due to back EMF or electromotive force. In such cases, the user should make sure that such voltages going below ground will not cause the IC and the system to malfunction by examining carefully all relevant factors and conditions such as motor characteristics, supply voltage, operating frequency and PCB wiring to name a few.

4. Ground Wiring Pattern

When using both small-signal and large-current ground traces, the two ground traces should be routed separately but connected to a single ground at the reference point of the application board to avoid fluctuations in the small-signal ground caused by large currents. Also ensure that the ground traces of external components do not cause variations on the ground voltage. The ground lines must be as short and thick as possible to reduce line impedance.

5. Thermal Consideration

Should by any chance the maximum junction temperature rating be exceeded the rise in temperature of the chip may result in deterioration of the properties of the chip. In case of exceeding this absolute maximum rating, increase the board size and copper area to prevent exceeding the maximum junction temperature rating.

6. Recommended Operating Conditions

These conditions represent a range within which the expected characteristics of the IC can be approximately obtained. The electrical characteristics are guaranteed under the conditions of each parameter.

7. Inrush Current

When power is first supplied to the IC, it is possible that the internal logic may be unstable and inrush current may flow instantaneously due to the internal powering sequence and delays, especially if the IC has more than one power supply. Therefore, give special consideration to power coupling capacitance, power wiring, width of ground wiring, and routing of connections.

8. Operation Under Strong Electromagnetic Field

Operating the IC in the presence of a strong electromagnetic field may cause the IC to malfunction.

9. Testing on Application Boards

When testing the IC on an application board, connecting a capacitor directly to a low-impedance output pin may subject the IC to stress. Always discharge capacitors completely after each process or step. The IC's power supply should always be turned off completely before connecting or removing it from the test setup during the inspection process. To prevent damage from static discharge, ground the IC during assembly and use similar precautions during transport and storage.

10. Inter-pin Short and Mounting Errors

Ensure that the direction and position are correct when mounting the IC on the PCB. Incorrect mounting may result in damaging the IC. Avoid nearby pins being shorted to each other especially to ground, power supply and output pin. Inter-pin shorts could be due to many reasons such as metal particles, water droplets (in very humid environment) and unintentional solder bridge deposited in between pins during assembly to name a few.

11. Unused Input Terminals

Input pins of an IC are often connected to the gate of a MOS transistor. The gate has extremely high impedance and extremely low capacitance. If left unconnected, the electric field from the outside can easily charge it. The small charge acquired in this way is enough to produce a significant effect on the conduction through the transistor and cause unexpected operation of the IC. So unless otherwise specified, unused input pins should be connected to the power supply or ground line.

Operational Notes – continued

12. Regarding Input Pins of the IC

This monolithic IC contains P+ isolation and P substrate layers between adjacent elements in order to keep them isolated. P-N junctions are formed at the intersection of the P layers with the N layers of other elements, creating a parasitic diode or transistor. For example (refer to figure below):

When $GND > Pin A$ and $GND > Pin B$, the P-N junction operates as a parasitic diode.
When $GND > Pin B$, the P-N junction operates as a parasitic transistor.

Parasitic diodes inevitably occur in the structure of the IC. The operation of parasitic diodes can result in mutual interference among circuits, operational faults, or physical damage. Therefore, conditions that cause these diodes to operate, such as applying a voltage lower than the GND voltage to an input pin (and thus to the P substrate) should be avoided.

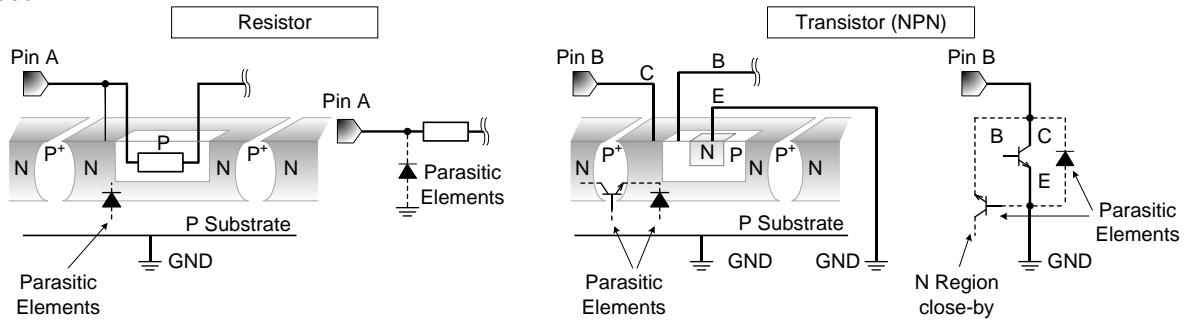

Figure 67. Example of Monolithic IC Structure

13. Ceramic Capacitor

When using a ceramic capacitor, determine a capacitance value considering the change of capacitance with temperature and the decrease in nominal capacitance due to DC bias and others.

14. Area of Safe Operation (ASO)

Operate the IC such that the output voltage, output current, and the maximum junction temperature rating are all within the Area of Safe Operation (ASO).

15. Thermal Shutdown Circuit (TSD)

This IC has a built-in thermal shutdown circuit that prevents heat damage to the IC. Normal operation should always be within the IC's maximum junction temperature rating. If however the rating is exceeded for a continued period, the junction temperature (T_j) will rise which will activate the TSD circuit that will turn OFF all output pins. When the T_j falls below the TSD threshold, the circuits are automatically restored to normal operation.

Note that the TSD circuit operates in a situation that exceeds the absolute maximum ratings and therefore, under no circumstances, should the TSD circuit be used in a set design or for any purpose other than protecting the IC from heat damage.

16. Over Current Protection Circuit (OCP)

This IC incorporates an integrated overcurrent protection circuit that is activated when the load is shorted. This protection circuit is effective in preventing damage due to sudden and unexpected incidents. However, the IC should not be used in applications characterized by continuous operation or transitioning of the protection circuit.

17. Disturbance Light

In a device where a portion of silicon is exposed to light such as in a WL-CSP, IC characteristics may be affected due to photoelectric effect. For this reason, it is recommended to come up with countermeasures that will prevent the chip from being exposed to light.

Ordering Information

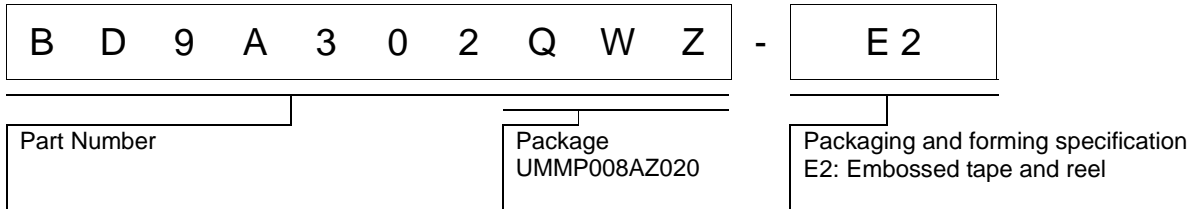

Marking Diagram

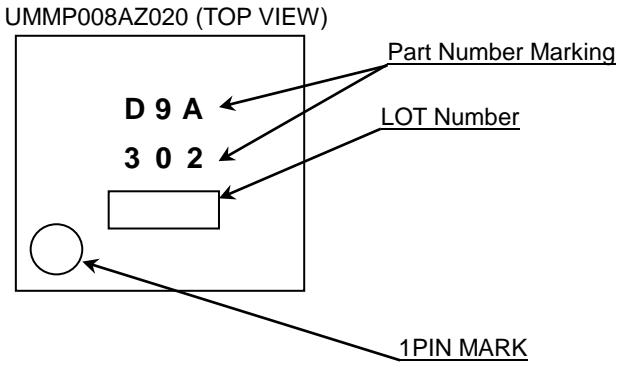

Revision History

| Date | Revision | Changes |
|-------------|----------|-------------|
| 14.Mar.2017 | 001 | New Release |

Notice

Precaution on using ROHM Products

- Our Products are designed and manufactured for application in ordinary electronic equipments (such as AV equipment, OA equipment, telecommunication equipment, home electronic appliances, amusement equipment, etc.). If you intend to use our Products in devices requiring extremely high reliability (such as medical equipment ^(Note 1), transport equipment, traffic equipment, aircraft/spacecraft, nuclear power controllers, fuel controllers, car equipment including car accessories, safety devices, etc.) and whose malfunction or failure may cause loss of human life, bodily injury or serious damage to property ("Specific Applications"), please consult with the ROHM sales representative in advance. Unless otherwise agreed in writing by ROHM in advance, ROHM shall not be in any way responsible or liable for any damages, expenses or losses incurred by you or third parties arising from the use of any ROHM's Products for Specific Applications.

(Note1) Medical Equipment Classification of the Specific Applications

| JAPAN | USA | EU | CHINA |
|-----------|-----------|------------|-----------|
| CLASS III | CLASS III | CLASS II b | CLASS III |
| CLASS IV | | CLASS III | |

- ROHM designs and manufactures its Products subject to strict quality control system. However, semiconductor products can fail or malfunction at a certain rate. Please be sure to implement, at your own responsibilities, adequate safety measures including but not limited to fail-safe design against the physical injury, damage to any property, which a failure or malfunction of our Products may cause. The following are examples of safety measures:
 - Installation of protection circuits or other protective devices to improve system safety
 - Installation of redundant circuits to reduce the impact of single or multiple circuit failure
- Our Products are designed and manufactured for use under standard conditions and not under any special or extraordinary environments or conditions, as exemplified below. Accordingly, ROHM shall not be in any way responsible or liable for any damages, expenses or losses arising from the use of any ROHM's Products under any special or extraordinary environments or conditions. If you intend to use our Products under any special or extraordinary environments or conditions (as exemplified below), your independent verification and confirmation of product performance, reliability, etc. prior to use, must be necessary:
 - Use of our Products in any types of liquid, including water, oils, chemicals, and organic solvents
 - Use of our Products outdoors or in places where the Products are exposed to direct sunlight or dust
 - Use of our Products in places where the Products are exposed to sea wind or corrosive gases, including Cl₂, H₂S, NH₃, SO₂, and NO₂
 - Use of our Products in places where the Products are exposed to static electricity or electromagnetic waves
 - Use of our Products in proximity to heat-producing components, plastic cords, or other flammable items
 - Sealing or coating our Products with resin or other coating materials
 - Use of our Products without cleaning residue of flux (even if you use no-clean type fluxes, cleaning residue of flux is recommended); or Washing our Products by using water or water-soluble cleaning agents for cleaning residue after soldering
 - Use of the Products in places subject to dew condensation
- The Products are not subject to radiation-proof design.
- Please verify and confirm characteristics of the final or mounted products in using the Products.
- In particular, if a transient load (a large amount of load applied in a short period of time, such as pulse. is applied, confirmation of performance characteristics after on-board mounting is strongly recommended. Avoid applying power exceeding normal rated power; exceeding the power rating under steady-state loading condition may negatively affect product performance and reliability.
- De-rate Power Dissipation depending on ambient temperature. When used in sealed area, confirm that it is the use in the range that does not exceed the maximum junction temperature.
- Confirm that operation temperature is within the specified range described in the product specification.
- ROHM shall not be in any way responsible or liable for failure induced under deviant condition from what is defined in this document.

Precaution for Mounting / Circuit board design

- When a highly active halogenous (chlorine, bromine, etc.) flux is used, the residue of flux may negatively affect product performance and reliability.
- In principle, the reflow soldering method must be used on a surface-mount products, the flow soldering method must be used on a through hole mount products. If the flow soldering method is preferred on a surface-mount products, please consult with the ROHM representative in advance.

For details, please refer to ROHM Mounting specification

Precautions Regarding Application Examples and External Circuits

1. If change is made to the constant of an external circuit, please allow a sufficient margin considering variations of the characteristics of the Products and external components, including transient characteristics, as well as static characteristics.
2. You agree that application notes, reference designs, and associated data and information contained in this document are presented only as guidance for Products use. Therefore, in case you use such information, you are solely responsible for it and you must exercise your own independent verification and judgment in the use of such information contained in this document. ROHM shall not be in any way responsible or liable for any damages, expenses or losses incurred by you or third parties arising from the use of such information.

Precaution for Electrostatic

This Product is electrostatic sensitive product, which may be damaged due to electrostatic discharge. Please take proper caution in your manufacturing process and storage so that voltage exceeding the Products maximum rating will not be applied to Products. Please take special care under dry condition (e.g. Grounding of human body / equipment / solder iron, isolation from charged objects, setting of Ionizer, friction prevention and temperature / humidity control).

Precaution for Storage / Transportation

1. Product performance and soldered connections may deteriorate if the Products are stored in the places where:
 - [a] the Products are exposed to sea winds or corrosive gases, including Cl₂, H₂S, NH₃, SO₂, and NO₂
 - [b] the temperature or humidity exceeds those recommended by ROHM
 - [c] the Products are exposed to direct sunshine or condensation
 - [d] the Products are exposed to high Electrostatic
2. Even under ROHM recommended storage condition, solderability of products out of recommended storage time period may be degraded. It is strongly recommended to confirm solderability before using Products of which storage time is exceeding the recommended storage time period.
3. Store / transport cartons in the correct direction, which is indicated on a carton with a symbol. Otherwise bent leads may occur due to excessive stress applied when dropping of a carton.
4. Use Products within the specified time after opening a humidity barrier bag. Baking is required before using Products of which storage time is exceeding the recommended storage time period.

Precaution for Product Label

A two-dimensional barcode printed on ROHM Products label is for ROHM's internal use only.

Precaution for Disposition

When disposing Products please dispose them properly using an authorized industry waste company.

Precaution for Foreign Exchange and Foreign Trade act

Since concerned goods might be fallen under listed items of export control prescribed by Foreign exchange and Foreign trade act, please consult with ROHM in case of export.

Precaution Regarding Intellectual Property Rights

1. All information and data including but not limited to application example contained in this document is for reference only. ROHM does not warrant that foregoing information or data will not infringe any intellectual property rights or any other rights of any third party regarding such information or data.
2. ROHM shall not have any obligations where the claims, actions or demands arising from the combination of the Products with other articles such as components, circuits, systems or external equipment (including software).
3. No license, expressly or implied, is granted hereby under any intellectual property rights or other rights of ROHM or any third parties with respect to the Products or the information contained in this document. Provided, however, that ROHM will not assert its intellectual property rights or other rights against you or your customers to the extent necessary to manufacture or sell products containing the Products, subject to the terms and conditions herein.

Other Precaution

1. This document may not be reprinted or reproduced, in whole or in part, without prior written consent of ROHM.
2. The Products may not be disassembled, converted, modified, reproduced or otherwise changed without prior written consent of ROHM.
3. In no event shall you use in any way whatsoever the Products and the related technical information contained in the Products or this document for any military purposes, including but not limited to, the development of mass-destruction weapons.
4. The proper names of companies or products described in this document are trademarks or registered trademarks of ROHM, its affiliated companies or third parties.

General Precaution

1. Before you use our Products, you are requested to carefully read this document and fully understand its contents. ROHM shall not be in any way responsible or liable for failure, malfunction or accident arising from the use of any ROHM's Products against warning, caution or note contained in this document.
2. All information contained in this document is current as of the issuing date and subject to change without any prior notice. Before purchasing or using ROHM's Products, please confirm the latest information with a ROHM sales representative.
3. The information contained in this document is provided on an "as is" basis and ROHM does not warrant that all information contained in this document is accurate and/or error-free. ROHM shall not be in any way responsible or liable for any damages, expenses or losses incurred by you or third parties resulting from inaccuracy or errors of or concerning such information.



BD9A302QWZ - Web Page

[Distribution Inventory](#)

| | |
|-----------------------------|--------------|
| Part Number | BD9A302QWZ |
| Package | UMMP008AZ020 |
| Unit Quantity | 4000 |
| Minimum Package Quantity | 4000 |
| Packing Type | Taping |
| Constitution Materials List | inquiry |
| RoHS | Yes |