

**Inolux Technologies 0.2" Dual Digit Numeric SMD Display  
 HNSD20 Series**

Official Product	HNSD20 Series	Customer Part No.		Data Sheet No.
	*****	*****		HNSD20 Series
Specifications are subject to change without notice. Data and drawings herein are copyrighted.		May 13, 2013	Version of 1.0	Page 1/18

**DISCLAIMER** ..... 3

**ORDERABLE INFORMATION** ..... 4

**FEATURES** ..... 5

**SCHEMATIC DRAWING** ..... 6

**PRODUCT CHARACTERISTIC** ..... 7

**ABSOLUTE MAXIMUM RATING** ..... 7

**ELECTRICAL AND OPTICAL CHARACTERISTIC** ..... 8

**RECOMMENDED SOLDER FOOTPRINT** ..... 9

**CHARACTERISTIC CURVES FOR UB** ..... 10

**CHARACTERISTIC CURVES FOR TG** ..... 11

**CHARACTERISTIC CURVES FOR UYG** ..... 12

**CHARACTERISTIC CURVES FOR UY** ..... 13

**CHARACTERISTIC CURVES FOR UA** ..... 14

**CHARACTERISTIC CURVES FOR UR** ..... 15

**CHARACTERISTIC CURVES FOR USR** ..... 16

**REFLOW SOLDERING** ..... 17

**SOLDERING IRON** ..... 17

**REWORK** ..... 17

**REVISION HISTORY** ..... 18

Official Product	HNSD20 Series	Customer Part No.		Data Sheet No.
	*****	*****		HNSD20 Series
Specifications are subject to change without notice. Data and drawings herein are copyrighted.		May 13, 2013	Version of 1.0	Page 2/18

## DISCLAIMER

- The information contained herein is presented only as a guide for the applications of our products.

No responsibility is assumed by INOLUX for any infringements of intellectual property or other rights of the third parties which may result from its use.

- Inolux is continually effort to improve the quality of its products. Nevertheless, semiconductor devices in general can malfunction or fail due to their inherent electrical sensitivity and vulnerability to physical stress. It is the responsibility of the buyer, when utilizing INOLUX products, to comply with the standards of safety in making a safe design for the entire system, and to avoid situations in which a malfunction or failure of such INOLUX products cause loss of human life, bodily injury or damage to property.
- The INOLUX products listed in this document are intended for usage in general electronics (computer, personal equipment, office equipment, industrial robotics, domestic, etc...) These products are neither intended nor warranted for usage in equipment that requires extraordinarily high quality and/or reliability or a malfunction or failure of which may cause loss of human life or bodily injury.
- In developing your designs, please ensure that INOLUX products are used within specified operating ranges as set forth in the most recent INOLUX products specifications.
- Also, please keep in mind the precautions listed in this document.

Official Product	HNSD20 Series	Customer Part No.		Data Sheet No.
	*****	*****		HNSD20 Series
Specifications are subject to change without notice. Data and drawings herein are copyrighted.		May 13, 2013	Version of 1.0	Page 3/18

**Orderable Information**

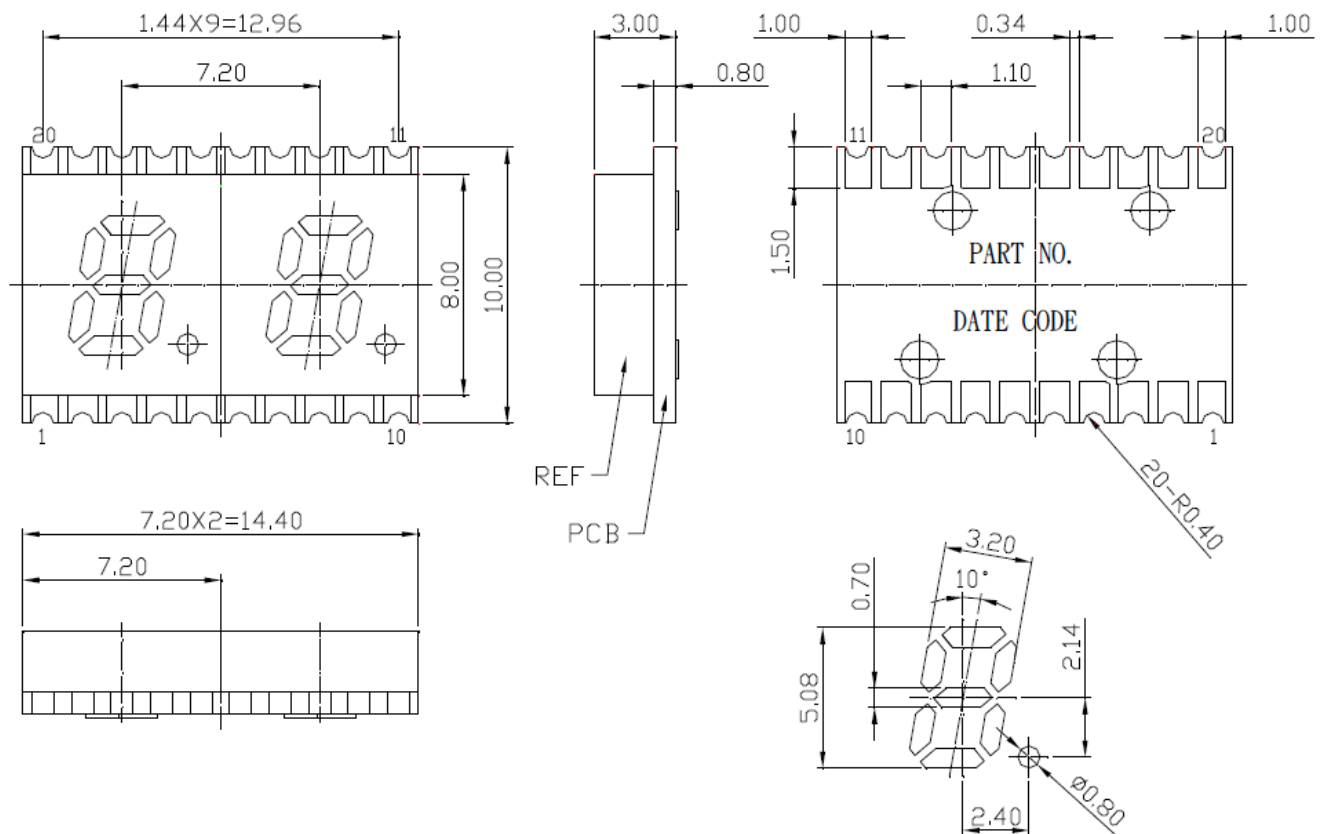
<b>H</b>	<b>N</b>	<b>S</b>	<b>D</b>	<b>20</b>	<b>X</b>	<b>X</b>	<b>X</b>	<b>-</b>	<b>X</b>	<b>X</b>	<b>X</b>	<b>X</b>
↓		↓		↓		↓			↓			
Series Name	Digit Height	Color Code				Polarity		Customer Code				
<b>HNSD</b> H: Inolux Technologies N: Numeric S: SMD Display D: Dual Digit	<b>20:</b> 0.2" Digit Height	<b>UB:</b> 470nm InGaN Blue <b>TG:</b> 525nm InGaN True Green <b>UYG:</b> 570nm AllnGaP Yellow Green <b>UY:</b> 590nm AllnGaP Yellow <b>UA:</b> 610nm AllnGaP Amber <b>UR:</b> 625nm AllnGaP Hyper Red <b>USR:</b> 640nm AllnGaP Super Red				<b>A:</b> Common Anode  <b>C:</b> Common Cathode		<b>XXXX:</b> Customer specific code				

Official Product	HNSD20 Series	Customer Part No.		Data Sheet No.
	*****	*****		HNSD20 Series
Specifications are subject to change without notice. Data and drawings herein are copyrighted.		May 13, 2013	Version of 1.0	Page 4/18



## Features

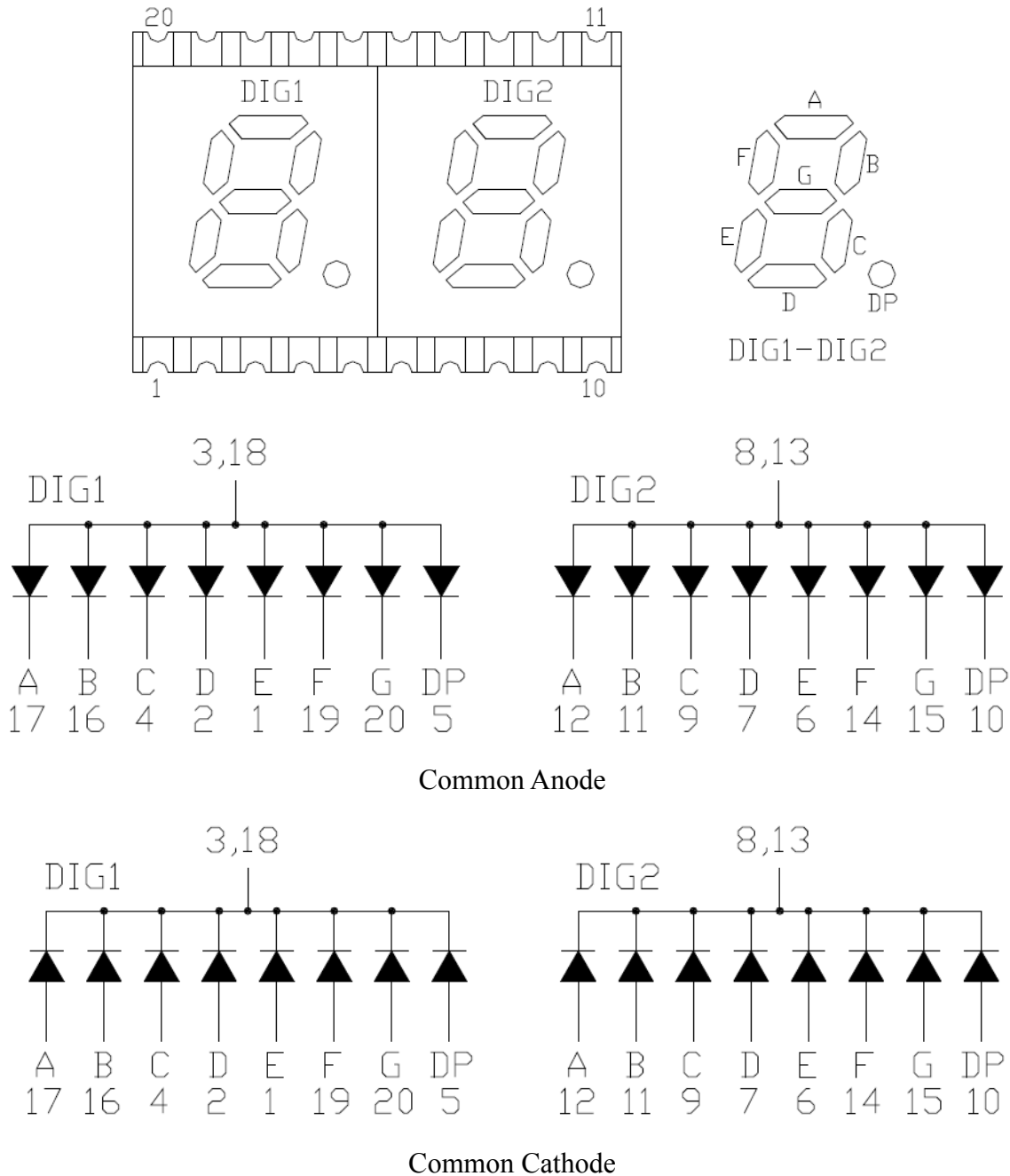
- 0.2" (5.08mm) Digit Height
- SMD Type Display
- Gray Face , White Segment
- RoHS Compliant, Pb Free



**Note:** Dimension is in millimeters. Tolerance is  $\pm 0.25$ mm unless otherwise noted.

Official Product	HNSD20 Series	Customer Part No.		Data Sheet No.
	*****	*****		HNSD20 Series
Specifications are subject to change without notice. Data and drawings herein are copyrighted.		May 13, 2013	Version of 1.0	Page 5/18

### Schematic Drawing



Official Product	HNSD20 Series	Customer Part No.	Data Sheet No.
	*****	*****	HNSD20 Series
Specifications are subject to change without notice. Data and drawings herein are copyrighted.	May 13, 2013	Version of 1.0	Page 6/18

## Product Characteristic

### Absolute Maximum Rating

(T<sub>a</sub> = 25°C)

Product	Emission Color	P <sub>AD</sub> (mW)	I <sub>AF</sub> (mA)	I <sub>PF</sub> (mA)	V <sub>R</sub> (V)	T <sub>OP</sub> (°C)	T <sub>ST</sub> (°C)	Derate From 25°C (mA/°C)
HNSD20UBA/ HNSD20UBC	Blue	120	30	100	5	-40 ~ +105	-40 ~ +105	0.3
HNSD20TGA/ HNSD20TGC	True Green	120	30	100	5	-40 ~ +105	-40 ~ +105	0.3
HNSD20UYGA/ HNSD20UYGC	Yellow Green	70	25	90	5	-40 ~ +105	-40 ~ +105	0.28
HNSD20UYA/ HNSD20UYC	Yellow	70	25	90	5	-40 ~ +105	-40 ~ +105	0.28
HNSD20UAA/ HNSD20UAC	Amber	70	25	90	5	-40 ~ +105	-40 ~ +105	0.28
HNSD20URA/ HNSD20URC	Hyper Red	70	25	90	5	-40 ~ +105	-40 ~ +105	0.28
HNSD20USRA/ HNSD20USRC	Super Red	75	30	100	5	-40 ~ +105	-40 ~ +105	0.3

Official Product	HNSD20 Series	Customer Part No.		Data Sheet No.
	*****	*****		HNSD20 Series
Specifications are subject to change without notice. Data and drawings herein are copyrighted.		May 13, 2013	Version of 1.0	Page 7/18

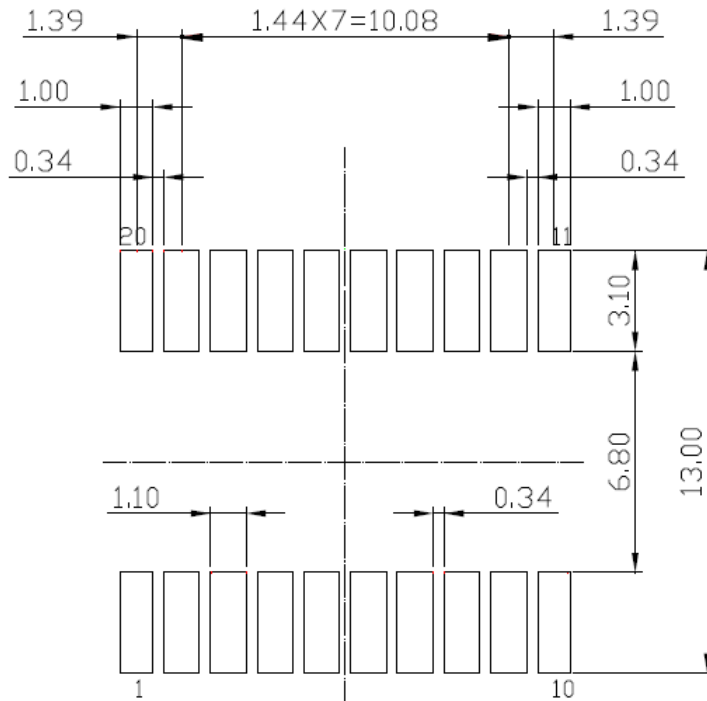
**Electrical and Optical Characteristic**

 (T<sub>a</sub>= 25°C )

Product	Emission Color	I <sub>F</sub> (mA)	V <sub>F</sub> (V)		λ (nm)		I <sub>V</sub> (mcd)	I <sub>R</sub> (μA)
			Typ.	Max.	λ <sub>d</sub>	Δλ	Typ.	Max
HNSD20UBA/ HNSD20UBC	Blue	20	3.2	4.0	470	30	20	10 (V <sub>R</sub> =8V)
HNSD20TGA/ HNSD20TGC	True Green	20	3.2	4.0	525	30	50	10 (V <sub>R</sub> =8V)
HNSD20UYGA/ HNSD20UYGC	Yellow Green	20	2.1	2.6	570	20	6.0	10 (V <sub>R</sub> =5V)
HNSD20UYA/ HNSD20UYC	Yellow	20	2.0	2.6	590	20	12	10 (V <sub>R</sub> =5V)
HNSD20UAA/ HNSD20UAC	Amber	20	2.0	2.6	610	20	12	10 (V <sub>R</sub> =5V)
HNSD20URA/ HNSD20URC	Hyper Red	20	2.0	2.6	625	20	12	10 (V <sub>R</sub> =5V)
HNSD20USRA/ HNSD20USRC	Super Red	20	2.0	2.6	640	20	2	10 (V <sub>R</sub> =5V)

Luminous Intensity tolerance = +/- 15%

Official Product	HNSD20 Series	Customer Part No.		Data Sheet No.
	*****	*****		HNSD20 Series
Specifications are subject to change without notice. Data and drawings herein are copyrighted.		May 13, 2013	Version of 1.0	Page 8/18

**Recommended Solder Footprint**


Official Product	HNSD20 Series	Customer Part No.		Data Sheet No.
	*****	*****		HNSD20 Series
Specifications are subject to change without notice. Data and drawings herein are copyrighted.		May 13, 2013	Version of 1.0	Page 9/18

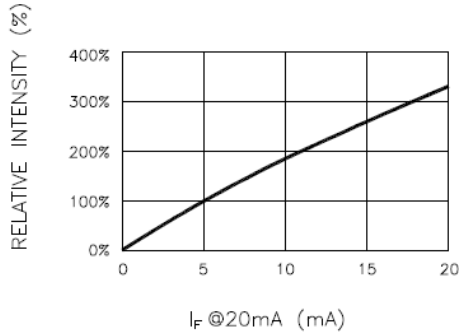
**Characteristic Curves for UB**


Fig.1 RELATIVE INTENSITY VS. FORWARD CURRENT

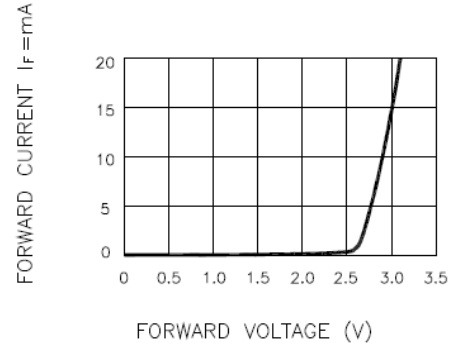


Fig.2 FORWARD CURRENT VS. FORWARD VOLTAGE

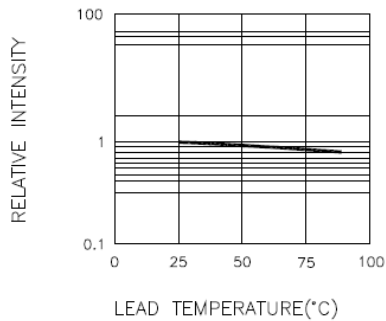
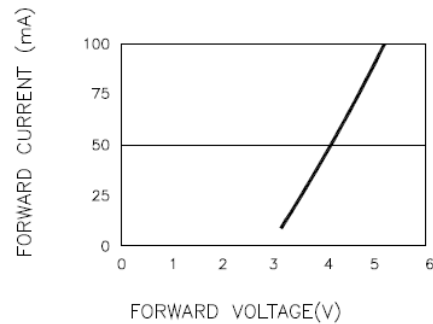
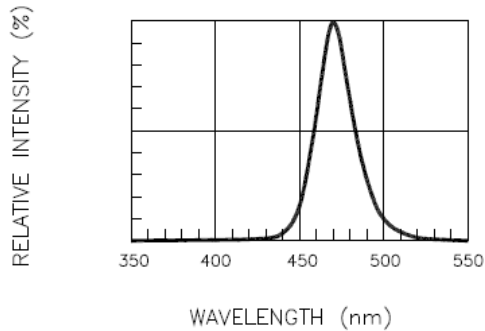
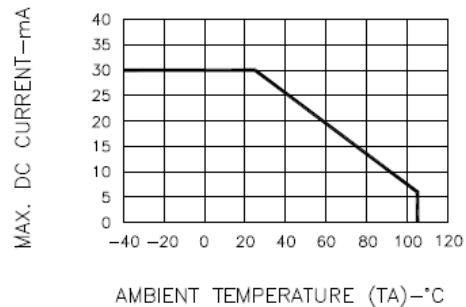

 Fig.3 RELATIVE INTENSITY VS. LEAD TEMPERATURE  
(PULSED 20 mA; 300us PULSE, 10ms PERIOD)

 Fig.4 PEAK FORWARD VOLTAGE VS. FORWARD  
(100us TEST PULSE, 1% DUTY CYCLE)


Fig.5 RELATIVE INTENSITY VS. WAVELENGTH


 Fig.6 MAX. ALLOWABLE DC CURRENT  
VS. AMBIENT TEMPERATURE

Official Product	HNSD20 Series	Customer Part No.	Data Sheet No.
	*****	*****	HNSD20 Series
Specifications are subject to change without notice. Data and drawings herein are copyrighted.		May 13, 2013	Version of 1.0
			Page 10/18

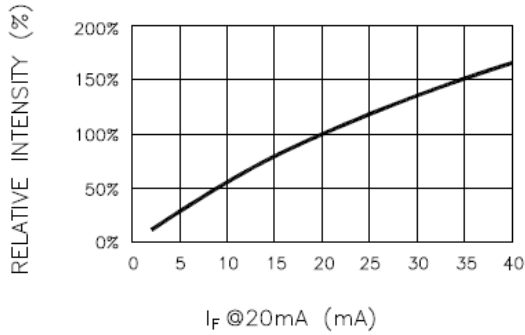
**Characteristic Curves for TG**


Fig.1 RELATIVE INTENSITY VS. FORWARD CURRENT

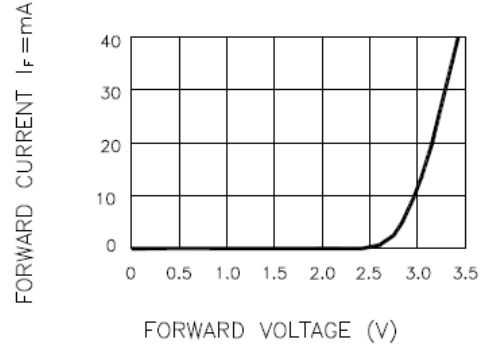


Fig.2 FORWARD CURRENT VS. FORWARD VOLTAGE

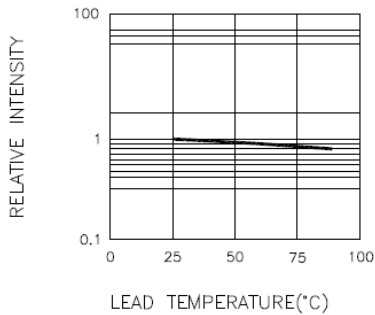
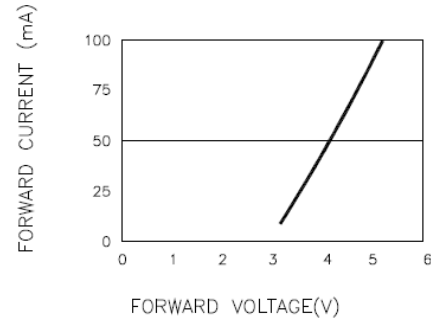
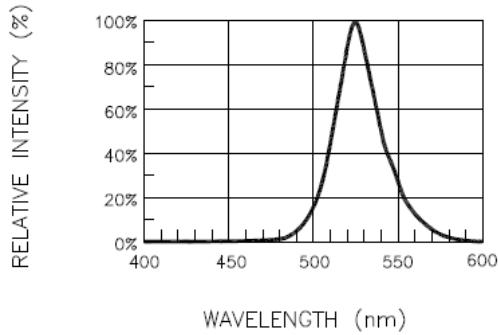
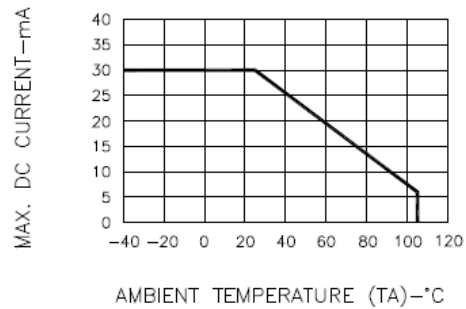

 Fig.3 RELATIVE INTENSITY VS. LEAD TEMPERATURE  
(PULSED 20 mA; 300us PULSE, 10ms PERIOD)

 Fig.4 PEAK FORWARD VOLTAGE VS. FORWARD  
(100us TEST PULSE, 1% DUTY CYCLE)


Fig.5 RELATIVE INTENSITY VS. WAVELENGTH


 Fig.6 MAX. ALLOWABLE DC CURRENT  
VS. AMBIENT TEMPERATURE

Official Product	HNSD20 Series	Customer Part No.	Data Sheet No.
	*****	*****	HNSD20 Series
Specifications are subject to change without notice. Data and drawings herein are copyrighted.	May 13, 2013	Version of 1.0	Page 11/18

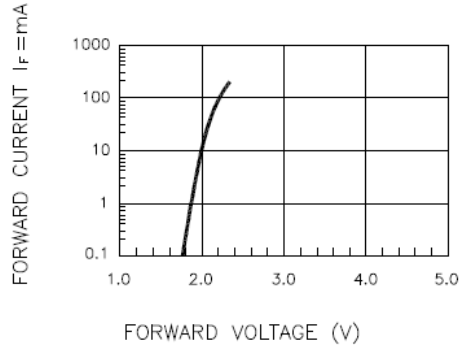
**Characteristic Curves for UYG**


Fig.1 FORWARD CURRENT VS. FORWARD VOLTAGE

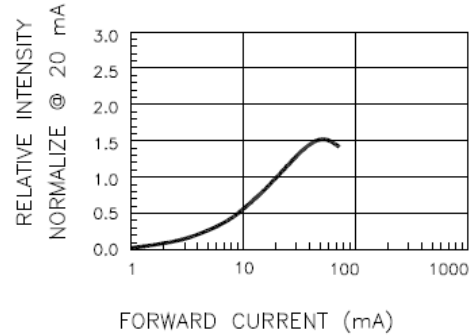


Fig.2 RELATIVE INTENSITY VS. FORWARD CURRENT

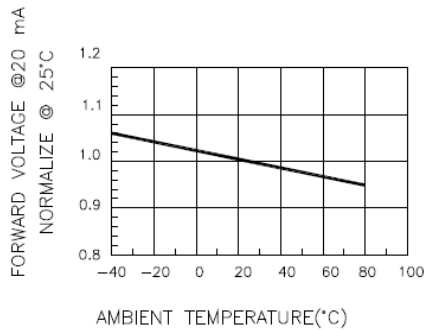


Fig.3 FORWARD VOLTAGE VS. TEMPERATURE

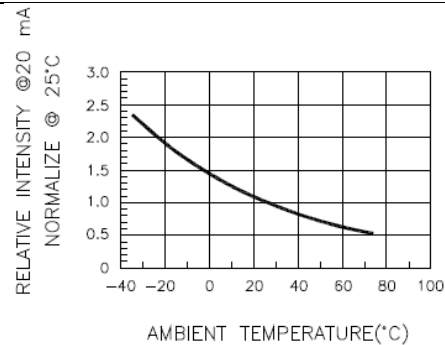


Fig.4 RELATIVE INTENSITY VS. TEMPERATURE

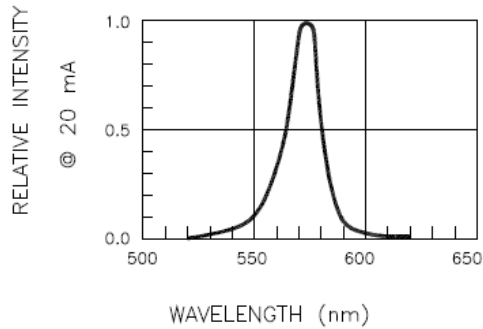


Fig.5 RELATIVE INTENSITY VS. WAVELENGTH

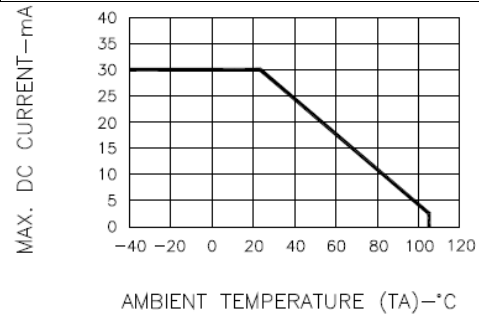


Fig.6 MAX. ALLOWABLE DC CURRENT VS. AMBIENT TEMPERATURE

Official Product	HNSD20 Series	Customer Part No.	Data Sheet No.
	*****	*****	HNSD20 Series
Specifications are subject to change without notice. Data and drawings herein are copyrighted.		May 13, 2013	Version of 1.0
			Page 12/18



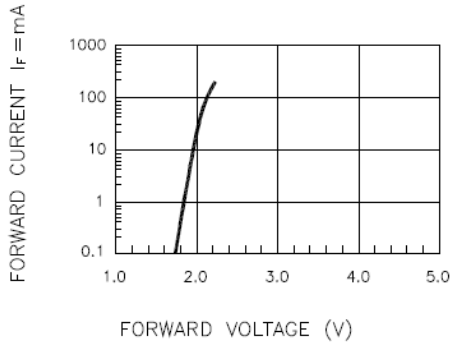
**Characteristic Curves for UY**


Fig.1 FORWARD CURRENT VS. FORWARD VOLTAGE

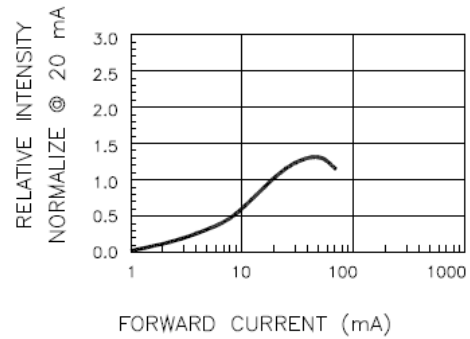


Fig.2 RELATIVE INTENSITY VS. FORWARD CURRENT

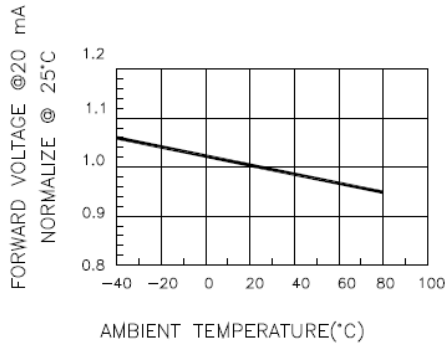


Fig.3 FORWARD VOLTAGE VS. TEMPERATURE

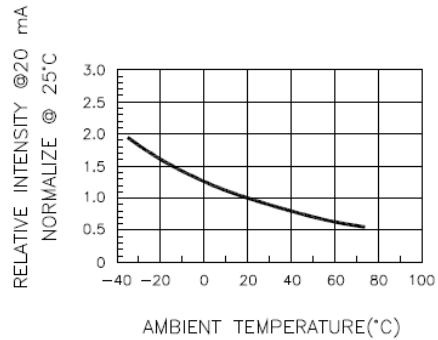


Fig.4 RELATIVE INTENSITY VS. TEMPERATURE

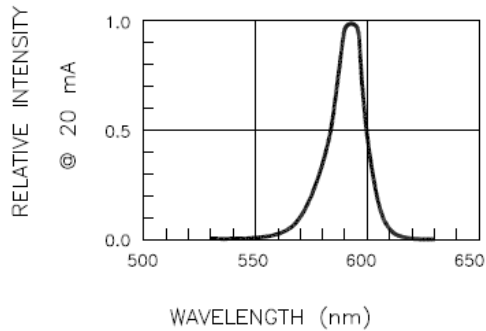


Fig.5 RELATIVE INTENSITY VS. WAVELENGTH

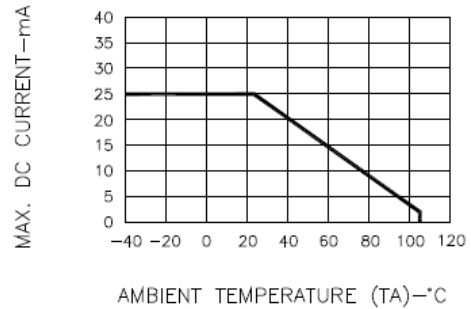


Fig.6 MAX. ALLOWABLE DC CURRENT VS. AMBIENT TEMPERATURE

Official Product	HNSD20 Series	Customer Part No.	Data Sheet No.
	*****	*****	HNSD20 Series
Specifications are subject to change without notice. Data and drawings herein are copyrighted.		May 13, 2013	Version of 1.0
			Page 13/18

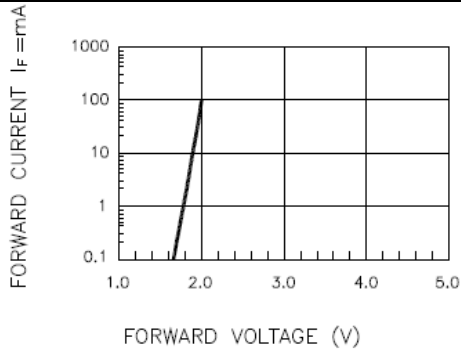
**Characteristic Curves for UA**


Fig.1 FORWARD CURRENT VS. FORWARD VOLTAGE

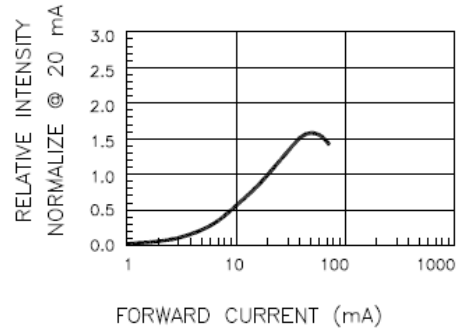


Fig.2 RELATIVE INTENSITY VS. FORWARD CURRENT

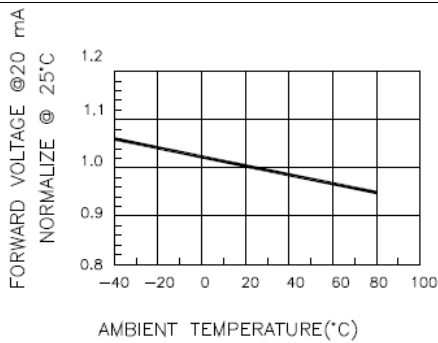


Fig.3 FORWARD VOLTAGE VS. TEMPERATURE

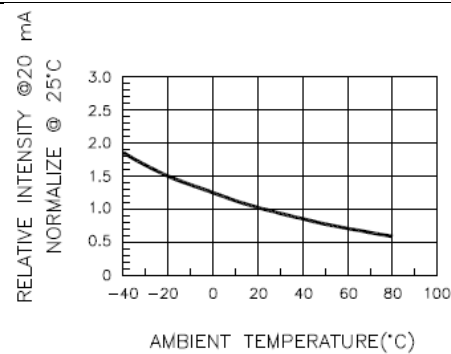


Fig.4 RELATIVE INTENSITY VS. TEMPERATURE

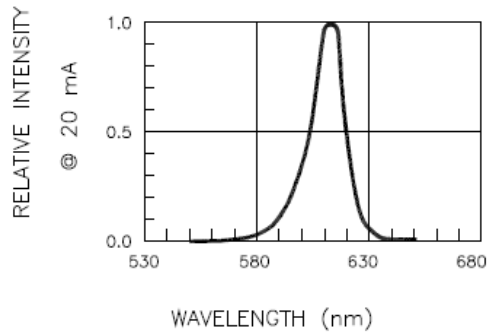


Fig.5 RELATIVE INTENSITY VS. WAVELENGTH

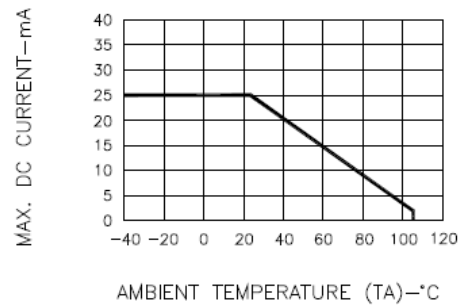


Fig.6 MAX. ALLOWABLE DC CURRENT VS. AMBIENT TEMPERATURE

Official Product	HNSD20 Series	Customer Part No.	Data Sheet No.
	*****	*****	HNSD20 Series
Specifications are subject to change without notice. Data and drawings herein are copyrighted.		May 13, 2013	Version of 1.0
			Page 14/18

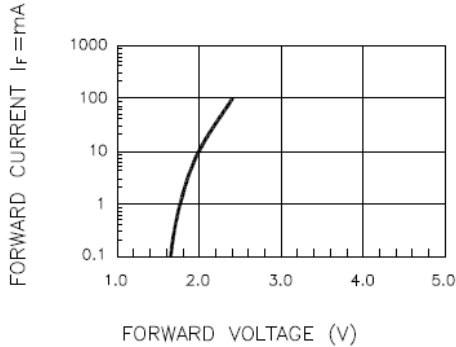
**Characteristic Curves for UR**


Fig.1 FORWARD CURRENT VS. FORWARD VOLTAGE

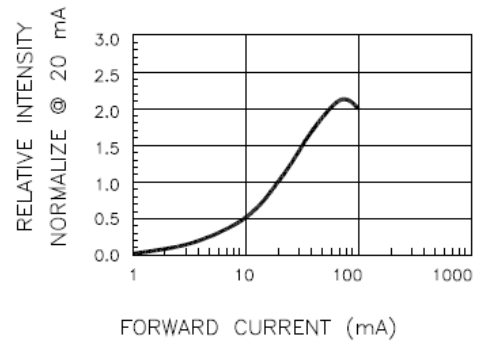


Fig.2 RELATIVE INTENSITY VS. FORWARD CURRENT

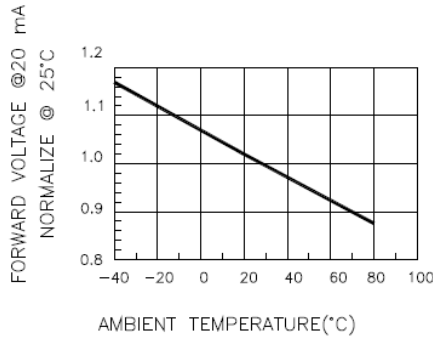


Fig.3 FORWARD VOLTAGE VS. TEMPERATURE

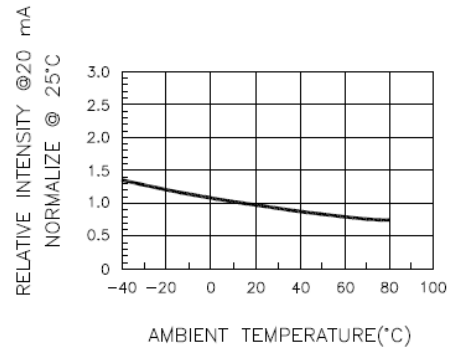


Fig.4 RELATIVE INTENSITY VS. TEMPERATURE

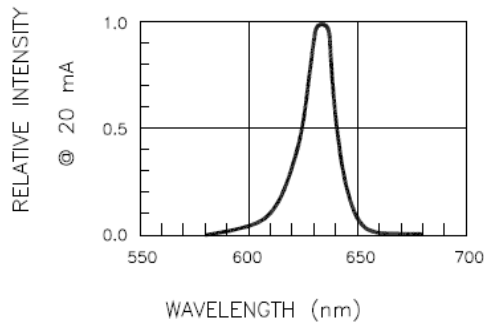


Fig.5 RELATIVE INTENSITY VS. WAVELENGTH

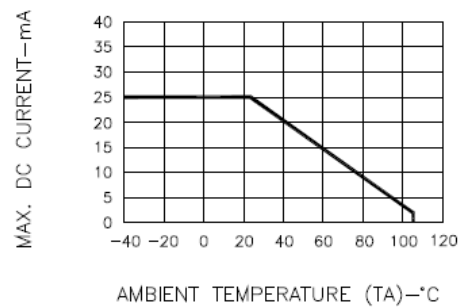


Fig.6 MAX. ALLOWABLE DC CURRENT VS. AMBIENT TEMPERATURE

Official Product	HNSD20 Series	Customer Part No.	Data Sheet No.
	*****	*****	HNSD20 Series
Specifications are subject to change without notice. Data and drawings herein are copyrighted.		May 13, 2013	Version of 1.0
			Page 15/18

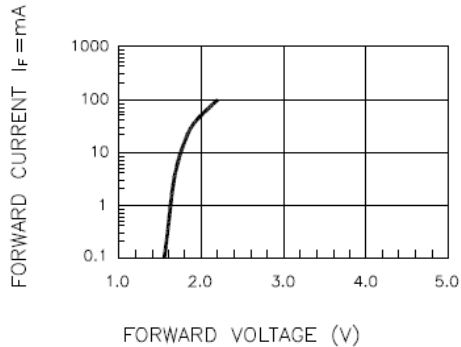
**Characteristic Curves for USR**


Fig.1 FORWARD CURRENT VS. FORWARD VOLTAGE

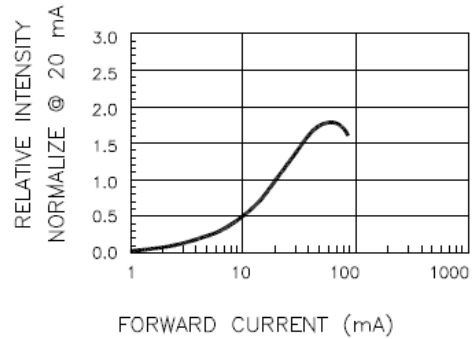


Fig.2 RELATIVE INTENSITY VS. FORWARD CURRENT

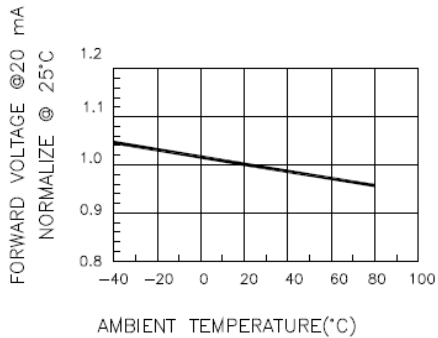


Fig.3 FORWARD VOLTAGE VS. TEMPERATURE

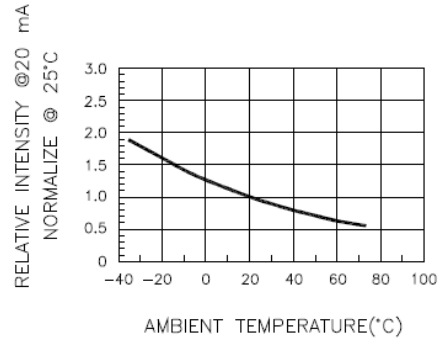


Fig.4 RELATIVE INTENSITY VS. TEMPERATURE

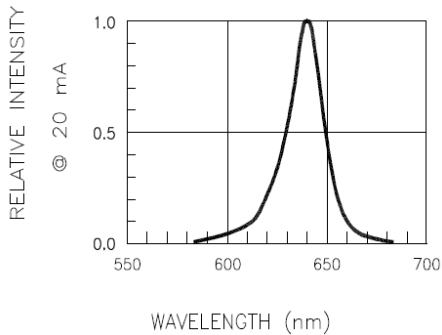


Fig.5 RELATIVE INTENSITY VS. WAVELENGTH

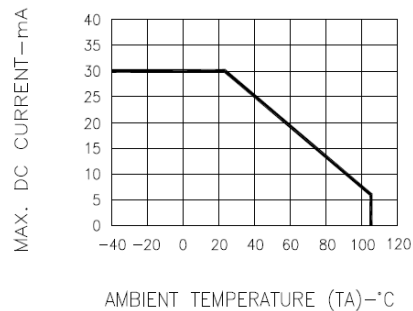
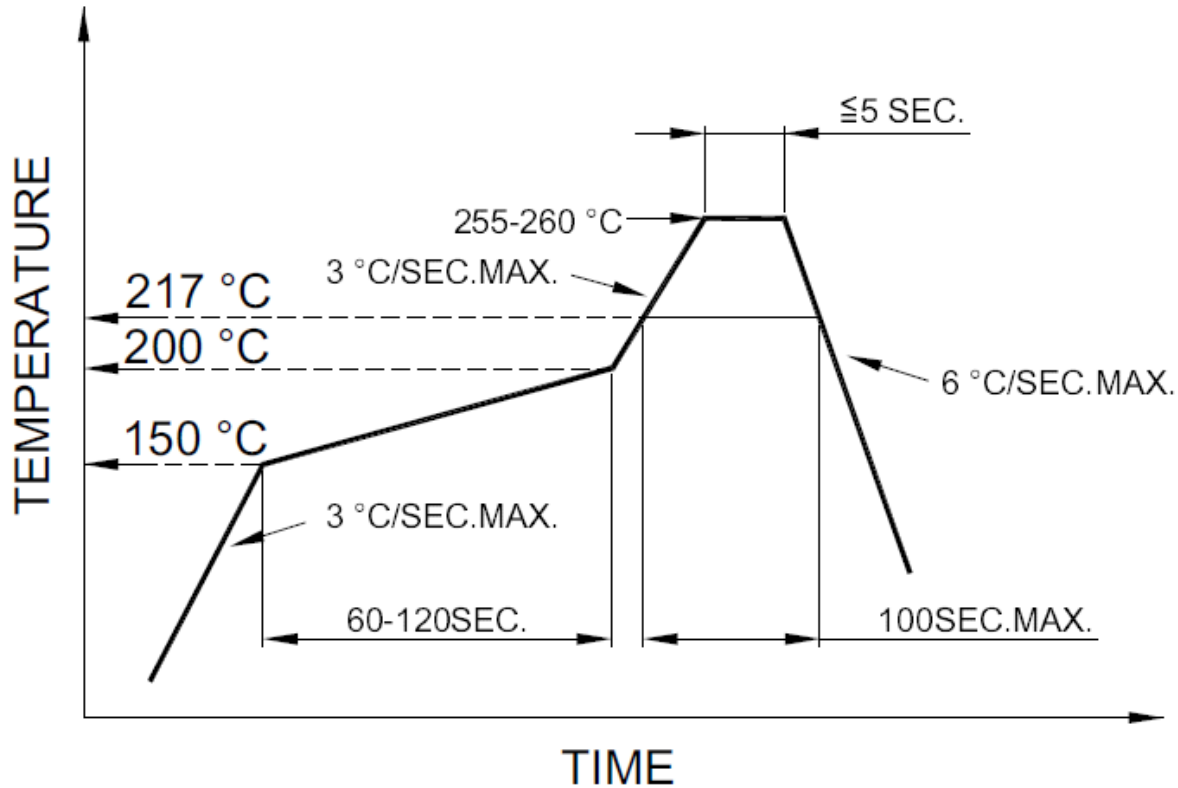


Fig.6 MAX. ALLOWABLE DC CURRENT VS. AMBIENT TEMPERATURE

Official Product	HNSD20 Series	Customer Part No.	Data Sheet No.
	*****	*****	HNSD20 Series
Specifications are subject to change without notice. Data and drawings herein are copyrighted.		May 13, 2013	Version of 1.0
			Page 16/18

## Reflow Soldering



Pb Free Reflow Soldering Profile

## Soldering Iron

Basic Spec is  $\leq 4$  sec. when 260°C (+10°C  $\rightarrow$  -1 second). Power dissipation of Iron should be less than 15W. Surface temperature should be under 230°C

## Rework

Rework should be completed within 3 second under 350°C

Official Product	HNSD20 Series	Customer Part No.		Data Sheet No.
	*****	*****		HNSD20 Series
Specifications are subject to change without notice. Data and drawings herein are copyrighted.		May 13, 2013	Version of 1.0	Page 17/18

## Revision History

Changes since last revision	Page	Version No.	Revision Date
Initial Release for HNSD20		1.0	05-13-2013

Official Product	HNSD20 Series	Customer Part No.	Data Sheet No.
	*****	*****	HNSD20 Series
Specifications are subject to change without notice. Data and drawings herein are copyrighted.		May 13, 2013	Version of 1.0
			Page 18/18