

LTM4620EV: High Efficiency, PolyPhase 50A Step-Down Power μ Module[®] Regulator

DESCRIPTION

Demonstration circuit 1780A-A features PolyPhase[®] design using the LTM[®]4620EV, the high efficiency, high density, dual 13A, switch mode step-down power module regulator. The input voltage is from 4.5V to 16V. The output voltage is jumper selectable from 1.0V to 2.5V. DC1780A-A can deliver nominal 50A output current with 2 \times LTM4620s in parallel. As explained in the data sheet, output current derating is necessary for certain V_{IN} , V_{OUT} , and thermal conditions. The LTM4620 on DC1780A-A always operate in continuous conduction mode. The switching frequency can be programmed through a resistor or can be synchronized to an external clock signal. The board allows the user to program how its output voltage ramps up and down through the TRACK_CONTROL pin. The output

voltage is tightly regulated between “ V_{OUT}^{+} ” and “ V_{OUT}^{-} ” through remote output voltage sensing which improves output voltage regulation at heavy loads. These features and the availability of the LTM4620EV in a compact 15mm \times 15mm \times 4.41mm LGA package make it ideal for use in many high-density point-of-load regulation applications. The LTM4620 data sheet must be read in conjunction with this demo manual prior to working on or modifying the demo circuit DC1780A-A.

Design files for this circuit board are available at <http://www.linear.com/demo>

LT, LT, LTC, LTM, Linear Technology, the Linear logo, μ Module and PolyPhase are registered trademarks of Linear Technology Corporation. All other trademarks are the property of their respective owners.

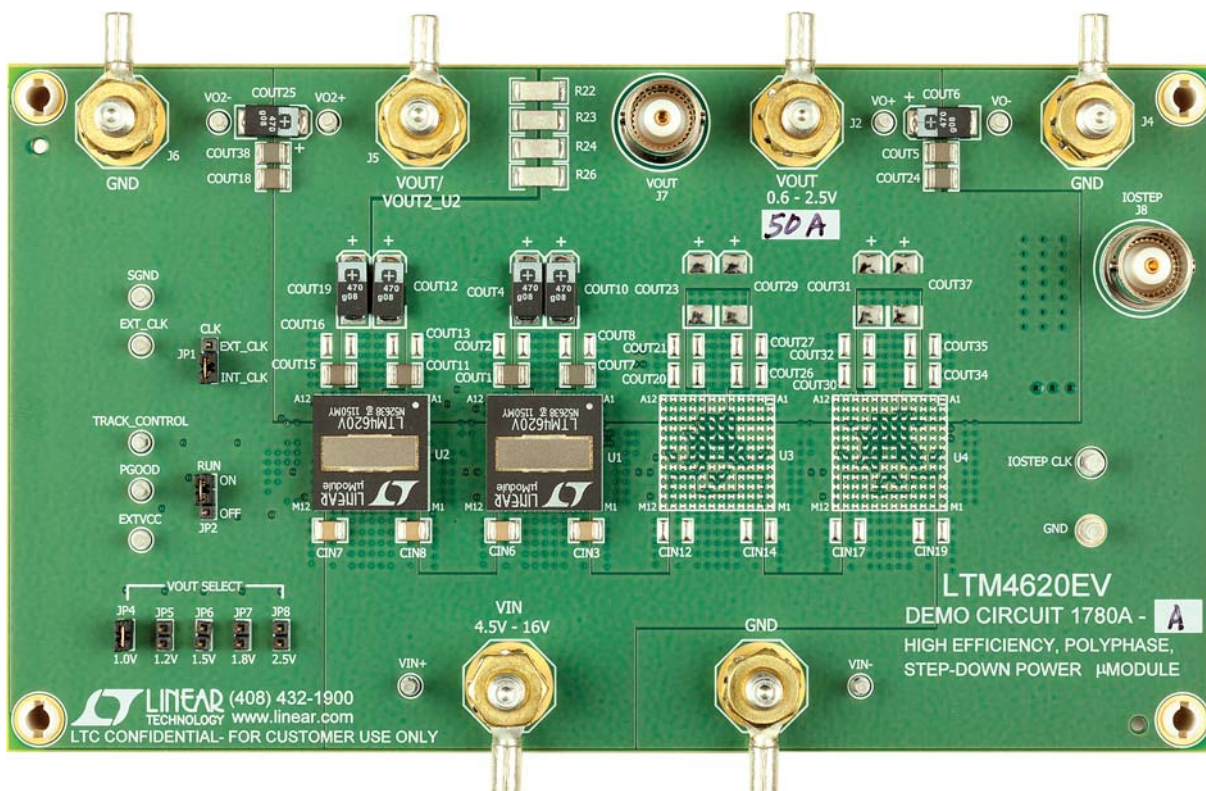

Figure 1. 50A PolyPhase LTM4620/DC1780A-A Demo Board

DEMO MANUAL DC1780A-A

PERFORMANCE SUMMARY Specifications are at $T_A = 25^\circ\text{C}$

PARAMETER	CONDITIONS/NOTES	VALUE
Input Voltage Range		4.5V to 16V
Output Voltage V_{OUT}	$V_{IN} = 4.5\text{V to }16\text{V}$, $I_{OUT} = 0\text{A to }50\text{A}$, JP4: 1.0V	$1.0\text{V} \pm 1.5\%$ (0.985V to 1.015V)
Maximum Continuous Output Current	Derating is necessary for certain V_{IN} , V_{OUT} and thermal conditions, see data sheet for detail.	50A
Default Operating Frequency		500kHz
Resistor Programmable Frequency Range		400kHz to 780kHz
External Clock Sync. Frequency Range		400kHz to 780kHz
Efficiency	$V_{IN} = 12\text{V}$, $V_{OUT} = 1.0\text{V}$, $I_{OUT} = 50\text{A}$, $f_{SW} = 500\text{kHz}$	82.4% See Figure 4
Load Transient	$V_{IN} = 12\text{V}$, $V_{OUT} = 1.0\text{V}$, $I_{SETP} = 25\text{A to }50\text{A}$	<138mV, See Figure 5
Output Voltage Ripple	$V_{IN} = 12\text{V}$, $V_{OUT} = 1.0\text{V}$, $I_{OUT} = 50\text{A}$	<10mV, See Figure 6

QUICK START PROCEDURE

Table 1. LTM4620 Demo Cards for up to 100A Point-of-Load Regulation

MAXIMUM OUTPUT CURRENT	NUMBER OF OUTPUT VOLTAGES	NUMBER OF LTM4620 μ MODULE REGULATORS ON THE BOARD	DEMO CARD NUMBER
13A, 13A	2	1	DC1498A
50A	1	2	DC1780A-A
75A	1	3	DC1780A-B
100A	1	4	DC1780A-C

Demonstration circuit DC1780A-A is easy to set up to evaluate the performance of PolyPhase operation of the LTM4620EV. Due to the high input/output current, select a proper input supply/load/cable which can sustain the full load operation. Please refer to Figure 2 for proper measurement setup and follow the procedure below:

- Place jumpers in the following positions for a typical 1.0V $_{OUT}$ application:

JP1	JP2	JP4-JP8
CLK	RUN	V_{OUT} SELECT
INT_CLK	OFF	ON JP4/1.0V

- With power off, connect the input power supply, load and meters as shown in Figure 2. Preset the load to 0A and V_{IN} supply to 12V.

- Turn on the power supply at the input. Place JP2 to ON position. The output voltage between V_{OUT}^+ and V_{OUT}^- should be $1.0\text{V} \pm 1.5\%$ (0.985V to 1.015V).
- Once the proper output voltage is established, adjust the load within the operating range and observe the output voltage regulation, output voltage ripple, efficiency and other parameters. Output voltage ripple should be measured at J7 with BNC cables. 50 Ω termination should be set on the oscilloscope or BNC cables.
- (Optional) For optional load transient test, apply an adjustable pulse signal between IOSTEP CLK and GND test point. The pulse amplitude (3V to 3.5V) sets the load step current amplitude. The output transient current can be monitored at the BNC connector J8 (5mV/A). The pulse signal should be very small duty cycle (< 10%) to limit the thermal stress on the transient load circuit.

QUICK START PROCEDURE

- 6. (Optional) LTM4620 can be synchronized to an external clock signal. Place the JP1 jumper on EXT_CLK and apply a clock signal (0V to 5V, square wave) on the EXT_CLK test point.
- 7. (Optional) The outputs of LTM4620 can track another supply. The output voltage tracks the voltage on TRACK_CONTROL when a valid signal is applied on the test point.
- 8. (Optional) DC1780A-A can be configured to a dual outputs configuration with V_{OUT} at 37A load current and V_{OUT2} at 13A load current. Stuff 0Ω resistor on R61 and $0.1\mu F$ on C14. Remove R22, R23, R24, R26, R27, R28, R32, R33, R35. Output voltage V_{OUT2} is set by R37 based on the equation $V_{OUT2} = 0.6V(1 + 60.4k/R37)$.

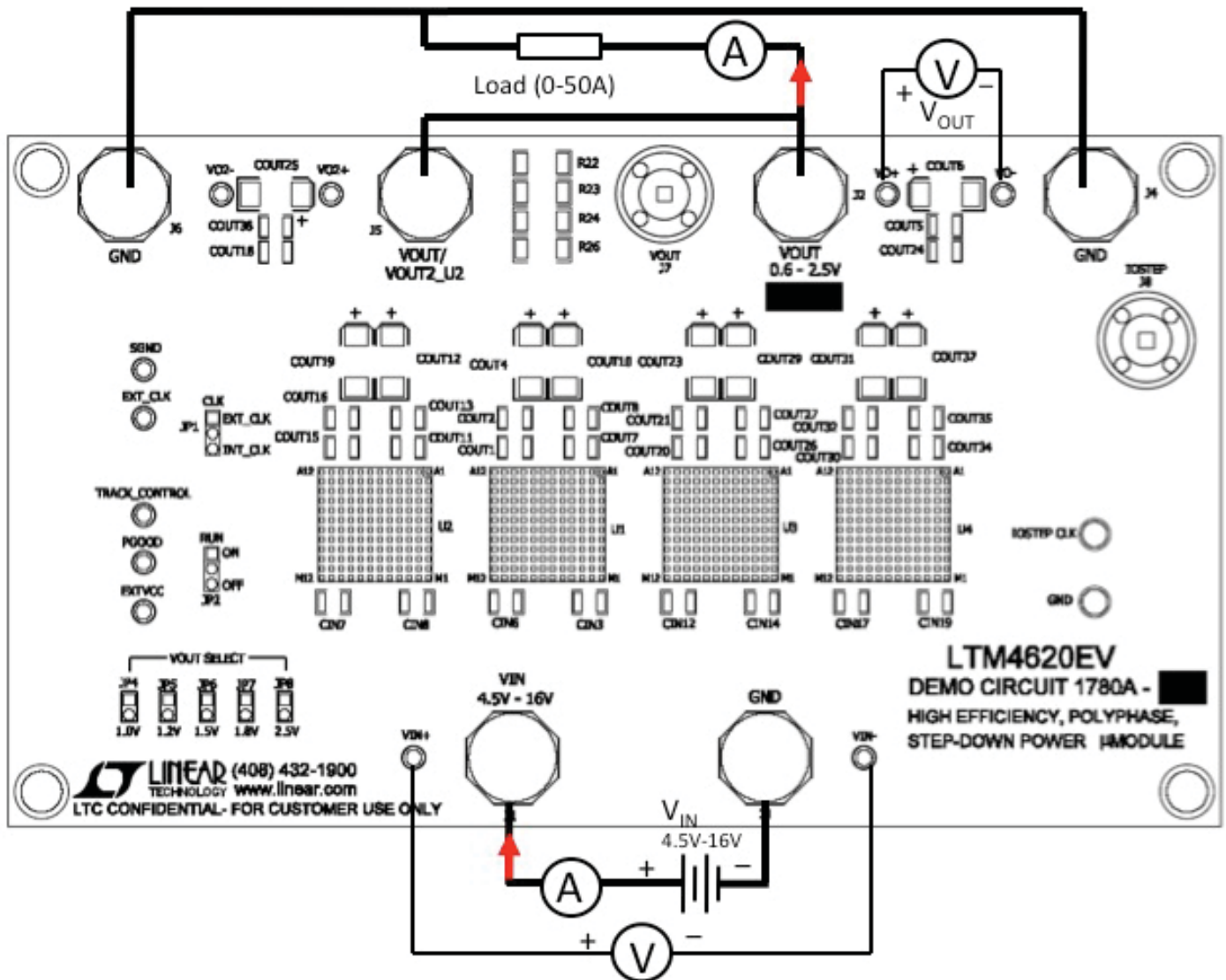

Figure 2. Test Setup of DC1780A-A

* Note: The output current is measured with a mV-voltage meter across a 1% accurate shunt resistor.

QUICK START PROCEDURE

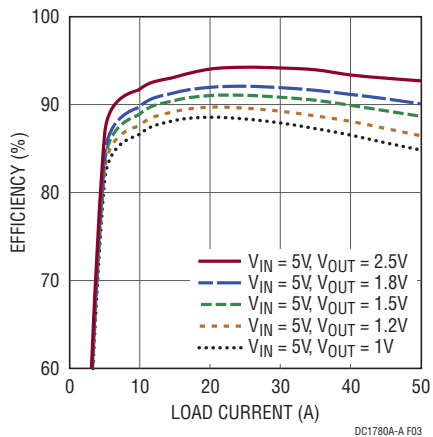

Figure 3. Measured Efficiency $V_{IN} = 5V$, $f_{SW} = 500kHz$

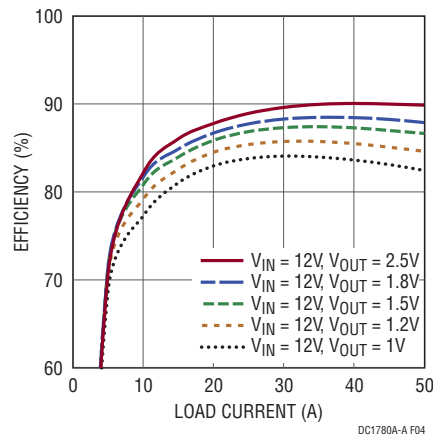

Figure 4. Measured Efficiency $V_{IN} = 12V$, $f_{SW} = 500kHz$

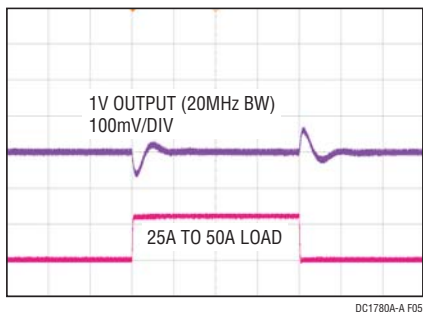

Figure 5. Load Transient 25A to 50A ($V_{IN} = 12V$, $V_{OUT} = 1V$)

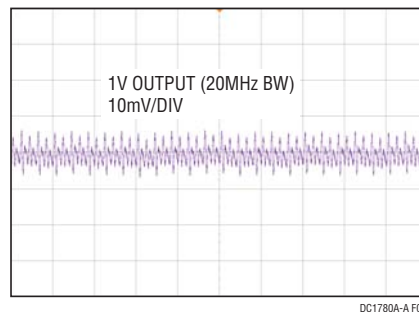

Figure 6. Measured Output Voltage Ripple at $12V_{IN}$, $1V_{OUT}$, 50A on J7 with Standard Demo Circuit Default Setup

QUICK START PROCEDURE

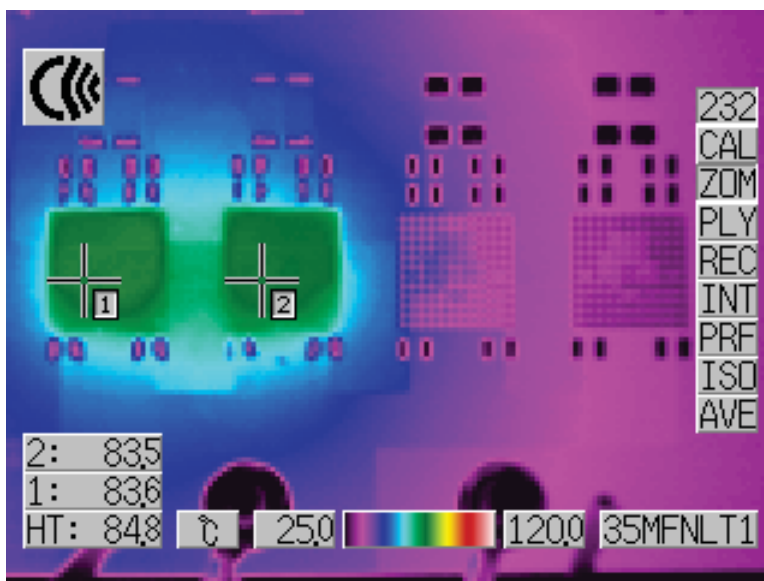

Figure 7. Thermal Capture at 12V_{IN}, 1.0V_{OUT} at 50A (Ambient Temperature = 23.3°C, No Airflow and No Heat Sink)

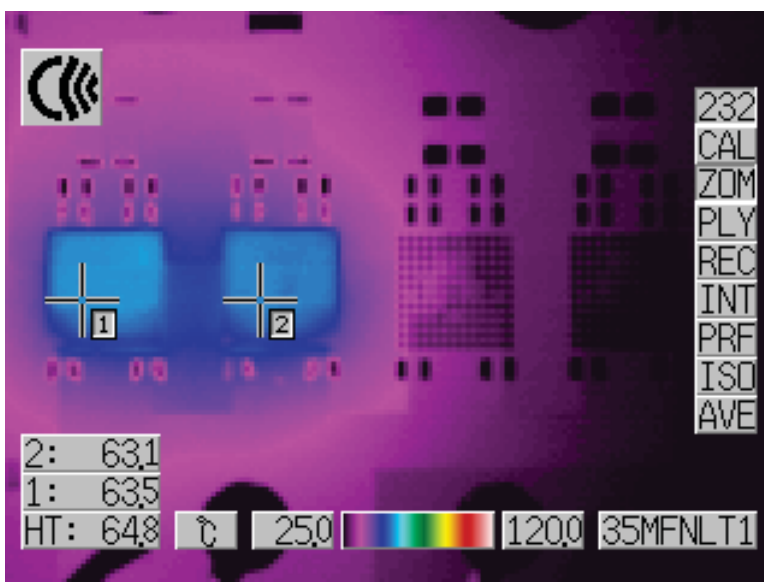

Figure 8, Thermal Capture at 12V_{IN}, 1.0V_{OUT} at 50A (Ambient Temperature = 23.3°C, 200LFM Airflow and No Heat Sink)

DEMO MANUAL DC1780A-A

PARTS LIST

ITEM	QTY	REFERENCE	PART DESCRIPTION	MANUFACTURER/PART NUMBER
Required Circuit Components				
1	8	CIN3, CIN4, CIN5, CIN6, CIN7, CIN8, CIN9, CIN10	Cap., X5R 22 μ F 25V 10% 1210	Murata GRM32ER61226KE15
2	4	COUT1, COUT7, COUT11, COUT15,	Cap., X5R 100 μ F 10V 20% 1210	Taiyo Yuden LMK325BJ107MN-T
3	4	COUT4, COUT10, COUT12, COUT19	Cap., POSCAP 470 μ F 4V 20% 7343	SANYO 4TPE470MCL
4	1	R14	Res., Chip 90.9k 0.06W 1% 0603	Vishay CRCW060390K9FKEA
5	2	R9, R31	Res., Chip 121k 0.06W 1% 0603	Vishay CRCW0603121KFKEA
6	2	R1, R3	Res., Chip 10 0.06W 5% 0603	Vishay CRCW060310R0JNEA
7	2	C4, C10	Cap., X5R 2.2 μ F 10V 20% 0603	Taiyo Yuden LMK107BJ225MA
8	1	C7	Cap., X7R 0.1 μ F 25V 10% 0603	AVX 06033C104KAT2A
9	2	U1, U2	I.C., Volt. Reg. LGA(144) 15MMX15MMX4.41MM(1873-REV0)	Linear Technology Corp. LTM4620EV
Additional Demo Board Circuit Components				
10	1	C25	Cap., X7R 0.1 μ F 25V 10% 0603	AVX 06033C104KAT2A
11	2	COUT5, COUT18, COUT24, COUT38	Cap., X5R 100 μ F 10V 20% 1210	Taiyo Yuden LMK325BJ107MN-T
12	2	COUT6, COUT25	Cap., POSCAP 470 μ F 4V 20% 7343	SANYO 4TPE470MCL
13	1	R15	Res., Chip 60.4k 0.06W 1% 0603	Vishay CRCW060360K4FKEA
14	1	R16	Res., Chip 40.2k 0.06W 1% 0603	Vishay CRCW060340K2FKEA
15	1	R17	Res., Chip 30.1k 0.06W 1% 0603	Vishay CRCW060330K1FKEA
16	1	R18	Res., Chip 19.1k 0.06W 1% 0603	Vishay CRCW060319K1FKEA
17	6	R2, R21, R39, R43, R47, R51	Res., Chip 121k 0.06W 1% 0603	Vishay CRCW0603121KFKEA
18	2	R25, R29	Res., Chip 10 Ω 0.06W 5% 0603	Vishay CRCW060310R0JNEA
19	2	C18, C22	Cap., X5R 2.2 μ F 10V 20% 0603	Taiyo Yuden LMK107BJ225MA
20	1	CIN1	Cap., Alum 150 μ F 25V 25% SUNCON-8	SUNCON 25CE150AX
21	2	CIN2, CIN11	Cap., X5R 1 μ F 25V 10% 1210	Taiyo Yuden TMK325BJ105KM
22	4	R22, R23, R24, R26	Res., 0 Ω 2010	TEPRO(NAKOMA) RNH6083
23	2	R56, R57	Res., 0.010 2W 1% 2512	Vishay WSL-2512-R01000-F-EA
24	0	R58, R59 (OPT)	Res., 2512	
25	1	R60	Res/Jumper, Chip 0 Ω 1/4W 1A 1206	Vishay CRCW12060000Z0EA
26	4	R4, R36, R41, R54	Res., Chip 10k 0.06W 5% 0603	Vishay CRCW060310K0JNEA
27	0	R5, R7, R8, R10, R13, R30, R34, R37, R38, R42, R44, R48, R49, R50, R52, R53, R55, R61 (OPT)	Res., 0603	
28	13	R6, R19, R20, R27, R28, R32, R33, R35, R40, R45, R46, R62, R63,	Res/Jumper, Chip 0 Ω 1/16W 1A 0603	Vishay CRCW06030000Z0EA
29	0	COUT23, COUT29, COUT31, COUT37 (OPT)	Cap., "D" Case 7343	
30	0	C1, C2, C3, C5, C8, C9, C12, C13, C14, C15, C16, C17, C20, C21, C26, C29, C30 (OPT)	Cap., 0603	
31	6	C6, C11, C19, C23, C27, C28	Cap., X7R 1 μ F 10V 10% 0603	Taiyo Yuden LMK107BJ105KA
32	1	C24	Cap., X7R 0.01 μ F 100V 10% 0603	AVX 06031C103KAT2A
33	2	Q1, Q2	Mosfet N-channel, 30V DPAK(TO-252)	Vishay Siliconix SUD50N03-09P

PARTS LIST

ITEM	QTY	REFERENCE	PART DESCRIPTION	MANUFACTURER/PART NUMBER
34	0	COUT2, COUT3, COUT8, COUT9, CIN12, COUT13, CIN13, COUT14, CIN14, CIN15, COUT16, CIN16, COUT17, CIN17, CIN18, CIN19, COUT20, COUT21, COUT22, COUT26, COUT27, COUT28, COUT30, COUT32, COUT33, COUT34, COUT35, COUT36 (OPT)	Cap., 1210	
Hardware for Demo Board only				
35	3	XJP1, XJP2, XJP4	Shunt, 2mm Ctrs.	Samtec 2SN-BK-G
36	4	MH1-MH4	STAND-OFF, NYLON 0.5" Tall	KEYSTONE, 8833 (SNAP ON)
37	2	J7, J8	BNC Connector	Connex 112404
38	2	JP1, JP2	Headers, 3 Pins 2mm Ctrs.	Samtec TMM-103-02-L-S
39	5	JP4, JP5, JP6, JP7, JP8	Jumper, 2 Pins 2mm Ctrs.	Samtec TMM-102-02-L-S
40	6	J1, J2, J3, J4, J5, J6	Stud, Test Pin	PEM KFH-032-10
41	11	E1, E2, E3, E4, E6, E7, E8, E9, E12, E13, E22	Turret, Test Point	Mill Max 2308-2-00-80-00-00-07-0
42	0	E5, E10, E11, E14, E15, E16, E17, E18 (Opt)	Test Point	
43	2	E19, E20	Turret, Test Point	Mill Max 2501-2-00-80-00-00-07-0
44	12		NUT, BRASS NUTS #10-32	ANY, #10-32
45	6		RING, LUG RING # 10	KEYSTONE, 8205
46	6		WASHER, #10, Tin Plated Brass	ANY, #10 EXT BZ TN

DEMO MANUAL DC1780A-A

SCHEMATIC DIAGRAM

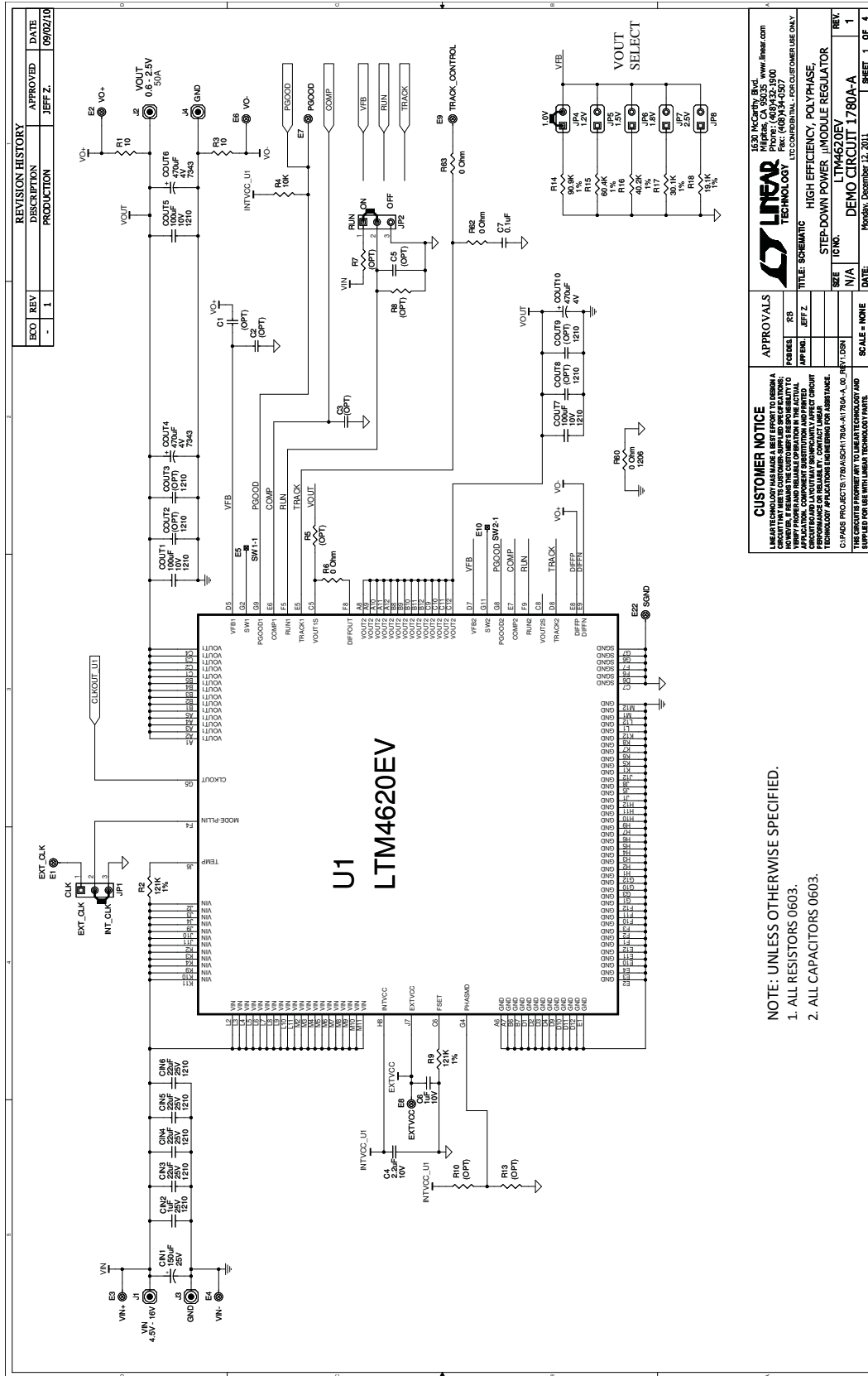

SCHEMATIC DIAGRAM

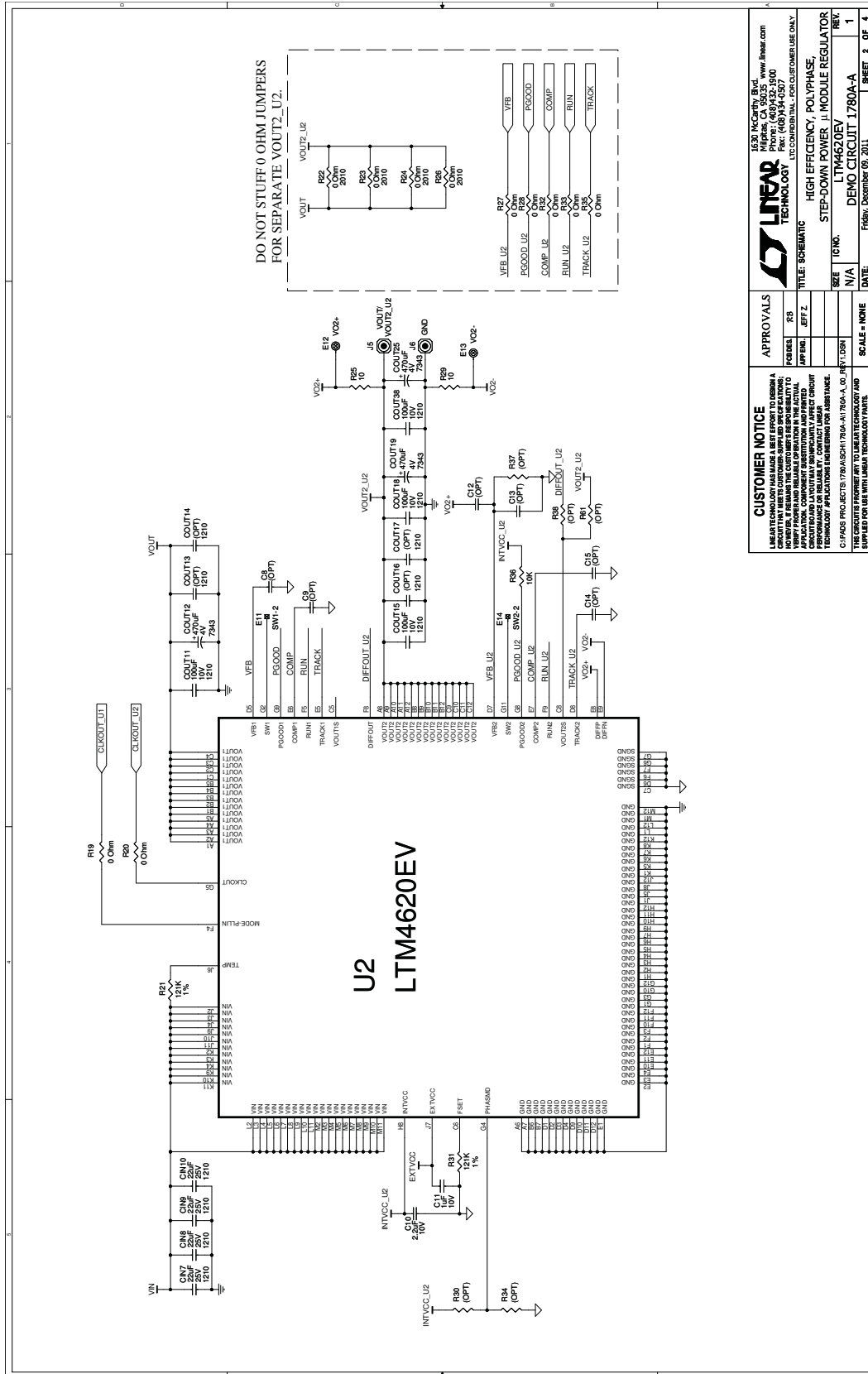

DEMO MANUAL DC1780A-A

SCHEMATIC DIAGRAM

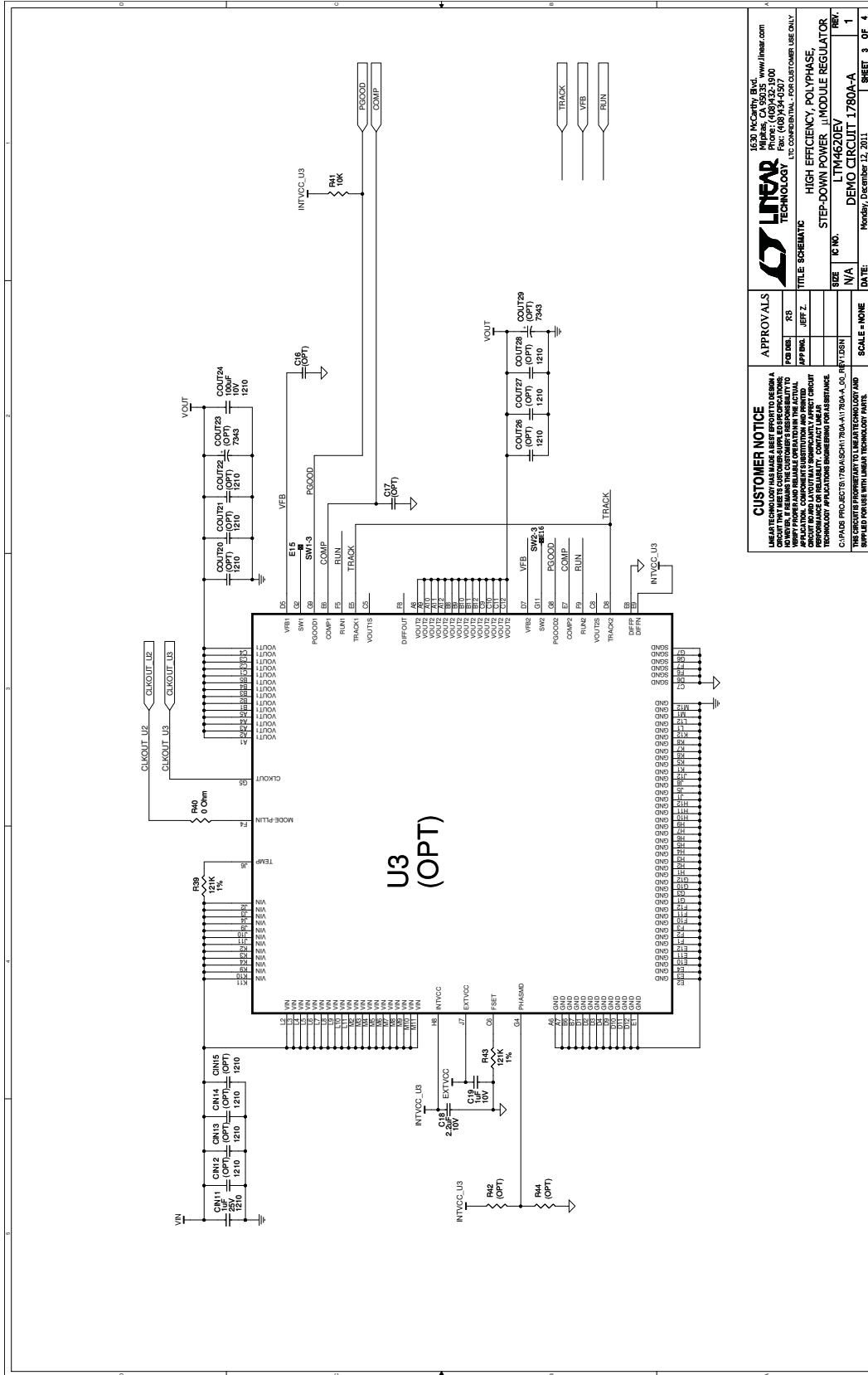

CUSTOMER NOTICE
 LINEAR TECHNOLOGY MAKES A BEST EFFORT TO DESIGN A CIRCUIT THAT MEETS CUSTOMER-SPECIFIED OPERATIONS. CUSTOMER SPECIFICATIONS ARE THE BASIS FOR THE DESIGN. VERIFY PROPER AND RELIABLE OPERATION IN THE ACTUAL APPLICATION. CUSTOMER SPECIFICATIONS MAY VARY FROM THE ACTUAL PERFORMANCE OF THE PRODUCT. CONTACT LINEAR TECHNOLOGY FOR APPLICATIONS INFORMATION, PERFORMANCE INFORMATION, OR RELIABILITY INFORMATION. CONTACT LINEAR TECHNOLOGY FOR APPLICATIONS INFORMATION, PERFORMANCE INFORMATION, OR RELIABILITY INFORMATION. CONTACT LINEAR TECHNOLOGY FOR APPLICATIONS INFORMATION, PERFORMANCE INFORMATION, OR RELIABILITY INFORMATION.

APPROVALS

DESIGNER	REV
DATE	DATE
SCALE	SCALE

LINEAR TECHNOLOGY
 1630 McCarthy Blvd., Milpitas, CA 95035-5080
 Tel: (415) 964-7000 Fax: (415) 964-7077
 ETC. CONFIDENTIAL - FOR CUSTOMER USE ONLY

STEP-DOWN POWER MODULE REGULATOR
 LTM4620EV
 DEMO CIRCUIT 1780A-A
 Monday, December 12, 2011

SIZE: N/A
 SHEET: 3 OF 4



SCHEMATIC DIAGRAM

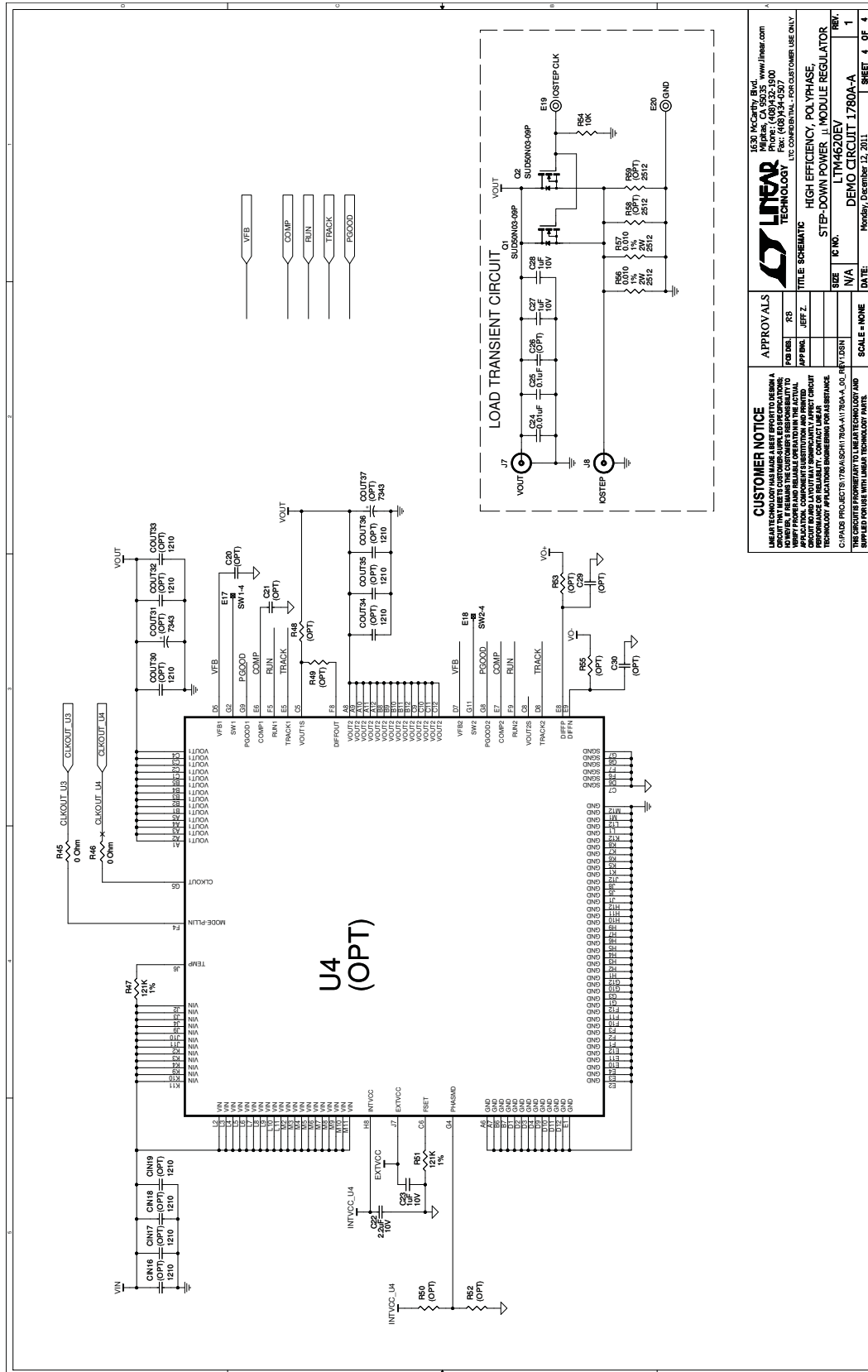

CUSTOMER NOTICE
 LINEAR TECHNOLOGY MAKES A BEST EFFORT TO DESIGN A CIRCUIT THAT MEETS CUSTOMER-SUPPLIED SPECIFICATIONS. HOWEVER, CUSTOMER-SUPPLIED SPECIFICATIONS MAY VARY FROM THE ACTUAL PERFORMANCE OF THE ACTUAL CIRCUIT. CUSTOMER SHOULD CONSULT WITH LINEAR TECHNOLOGY FOR PERFORMANCE OR RELIABILITY. CONTACT LINEAR TECHNOLOGY FOR APPLICATIONS ENGINEERING PERFORMANCE AND SUPPORT INFORMATION WITH LINEAR TECHNOLOGY PART AND SUPPLY SOURCES WITH LINEAR TECHNOLOGY PARTS.

APPROVALS

DESIGNED BY	RS
CHECKED BY	JEFF Z
DATE	

LINEAR TECHNOLOGY
 1630 McCarthy Blvd.
 Milpitas, CA 95035-5000
 Tel: (415) 964-8700
 Fax: (415) 964-0307
 ETC. CONFIDENTIAL - FOR CUSTOMER USE ONLY

STEP-DOWN POWER, 11 MODULE REGULATOR

SIZE	11
W/ NO.	N/A
REV.	1
DATE	Moody, December 12, 2011

DEMO CIRCUIT 1780A-A

SHEET 4 OF 4

DEMO MANUAL DC1780A-A

DEMONSTRATION BOARD IMPORTANT NOTICE

Linear Technology Corporation (LTC) provides the enclosed product(s) under the following **AS IS** conditions:

This demonstration board (DEMO BOARD) kit being sold or provided by Linear Technology is intended for use for **ENGINEERING DEVELOPMENT OR EVALUATION PURPOSES ONLY** and is not provided by LTC for commercial use. As such, the DEMO BOARD herein may not be complete in terms of required design-, marketing-, and/or manufacturing-related protective considerations, including but not limited to product safety measures typically found in finished commercial goods. As a prototype, this product does not fall within the scope of the European Union directive on electromagnetic compatibility and therefore may or may not meet the technical requirements of the directive, or other regulations.

If this evaluation kit does not meet the specifications recited in the DEMO BOARD manual the kit may be returned within 30 days from the date of delivery for a full refund. **THE FOREGOING WARRANTY IS THE EXCLUSIVE WARRANTY MADE BY THE SELLER TO BUYER AND IS IN LIEU OF ALL OTHER WARRANTIES, EXPRESSED, IMPLIED, OR STATUTORY, INCLUDING ANY WARRANTY OF MERCHANTABILITY OR FITNESS FOR ANY PARTICULAR PURPOSE. EXCEPT TO THE EXTENT OF THIS INDEMNITY, NEITHER PARTY SHALL BE LIABLE TO THE OTHER FOR ANY INDIRECT, SPECIAL, INCIDENTAL, OR CONSEQUENTIAL DAMAGES.**

The user assumes all responsibility and liability for proper and safe handling of the goods. Further, the user releases LTC from all claims arising from the handling or use of the goods. Due to the open construction of the product, it is the user's responsibility to take any and all appropriate precautions with regard to electrostatic discharge. Also be aware that the products herein may not be regulatory compliant or agency certified (FCC, UL, CE, etc.).

No License is granted under any patent right or other intellectual property whatsoever. **LTC assumes no liability for applications assistance, customer product design, software performance, or infringement of patents or any other intellectual property rights of any kind.**

LTC currently services a variety of customers for products around the world, and therefore this transaction **is not exclusive**.

Please read the DEMO BOARD manual prior to handling the product. Persons handling this product must have electronics training and observe good laboratory practice standards. **Common sense is encouraged.**

This notice contains important safety information about temperatures and voltages. For further safety concerns, please contact a LTC application engineer.

Mailing Address:

Linear Technology
1630 McCarthy Blvd.
Milpitas, CA 95035

Copyright © 2004, Linear Technology Corporation