



TAI-SAW TECHNOLOGY CO., LTD.

No. 3, Industrial 2nd Rd., Ping-Chen Industrial District,
Taoyuan, 324, Taiwan, R.O.C.

TEL: 886-3-4690038 FAX: 886-3-4697532

E-mail: tstsales@mail.taisaw.com Web: www.taisaw.com

Product Specifications Approval Sheet

Issued Date: August , 10, 2011

Product Name: SAW Filter 915 MHz SMD 3.0x3.0 mm(BW=1MHz)

TST Parts No.:TA1392A

Customer Parts No.: _____

| |
|---------------------|
| Company: _____ |
| Division: _____ |
| Approved by : _____ |
| Date: _____ |

Checked by: _____ Paul Ni *Paul Ni*

Approval by: _____ Francis Chen *NOV 2*

Date: _____ 08, 10, 2011

1. Customer signed back is required before TST can proceed with sample build and receive orders.
2. Orders received without customer signed back will be regarded as agreement on the specifications.
3. Any specifications changes must be approved upon by both parties and a new revision of specifications shall be released to reflect the changes.



TAI-SAW TECHNOLOGY CO., LTD.

No. 3, Industrial 2nd Rd., Ping-Chen Industrial District,
Taoyuan, 324, Taiwan, R.O.C.

TEL: 886-3-4690038 FAX: 886-3-4697532

E-mail: tstsales@mail.taisaw.com Web: www.taisaw.com

SAW Filter 915 MHz

MODEL NO.:TA1392A

REV. NO : 1.0

A. MAXIMUM RATING:

1. Input Power Level: 10 dBm
2. DC Voltage : 6V
3. Operating Temperature: -40°C to +85°C
4. Storage Temperature: -40°C to +85°C

RoHS Compliant
Lead free
Lead-free soldering

Electrostatic Sensitive Device

B. ELECTRICAL CHARACTERISTICS:

| Item | Unit | Min. | Typ. | Max. |
|---|------|--------------|------|------|
| Center frequency Fc | MHz | - | 915 | - |
| 3dB BW | MHz | - | 2.0 | - |
| Minimum insertion loss IL(min) | | | | |
| Exclude loss in matching elements *1) | dB | - | 2.7 | 4.0 |
| Incl. loss of matching elements(Q=89) *2) | dB | - | 3.9 | 5.0 |
| Passband (relative to IL _{min}) *1) | | | | |
| 914.50 ~ 915.50 MHz | dB | - | 0.4 | 2.5 |
| 914.30 ~ 915.70 MHz | dB | - | 1.0 | 5.0 |
| Attenuation (relative to IL _{min}) *1) | | | | |
| 10.000 ~ 830.00 MHz | dB | 47 | 53 | - |
| 830.00 ~ 890.00 MHz | dB | 41 | 46 | - |
| 890.00 ~ 903.00 MHz | dB | 36 | 42 | - |
| 903.00 ~ 911.50 MHz | dB | 19 | 28 | - |
| 920.00 ~ 923.00 MHz | dB | 19 | 28 | - |
| 923.00 ~ 943.00 MHz | dB | 19 | 24 | - |
| 943.00 ~ 1000.0 MHz | dB | 37 | 43 | - |
| 1000.0 ~ 2500.0 MHz | dB | 43 | 48 | - |
| Impedance at Fc, Input *1) Z _{in} = R _{in} //C _{in} Z _s | Ω | 354Ω//1.88pF | | |
| Impedance at Fc, Output *1) Z _{out} = R _{out} //C _{out} Z _L | Ω | 334Ω//1.93pF | | |

*1): The matching circuit is ideal by simulation.

*2): The matching circuit is real by actual passive components.
0805 Coilcraft CS series chip conductor is used for inductor.
0402 muRata GRM series is used for capacitor.

C. Frequency Characteristics :

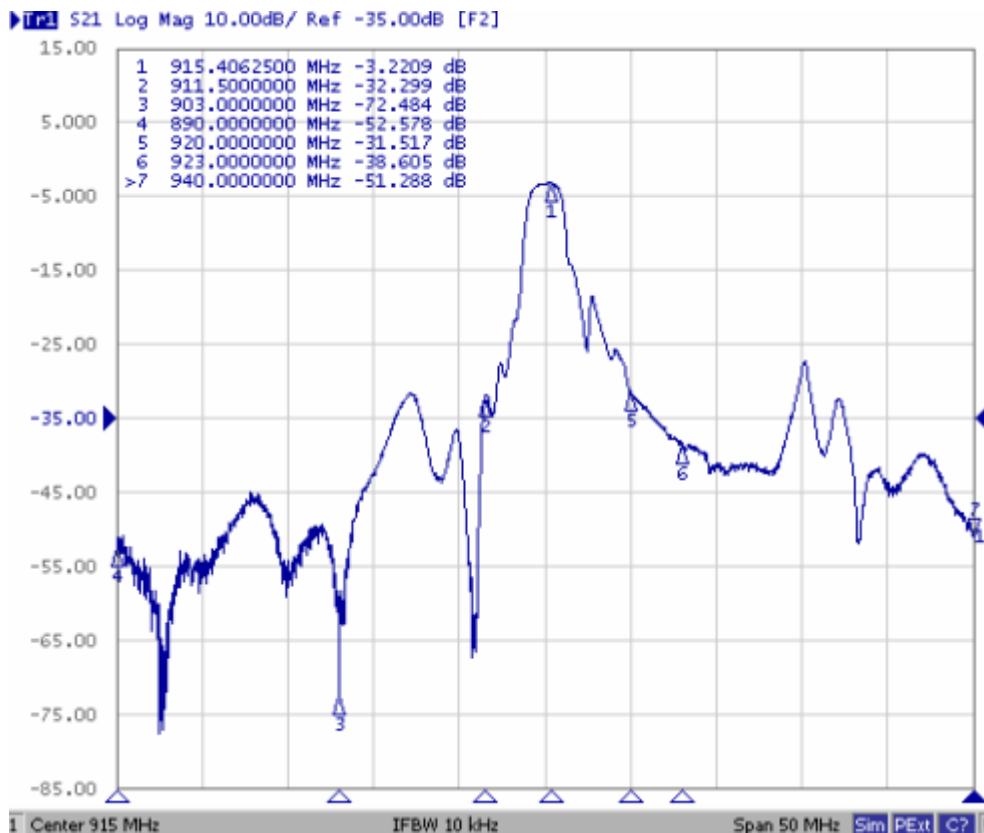

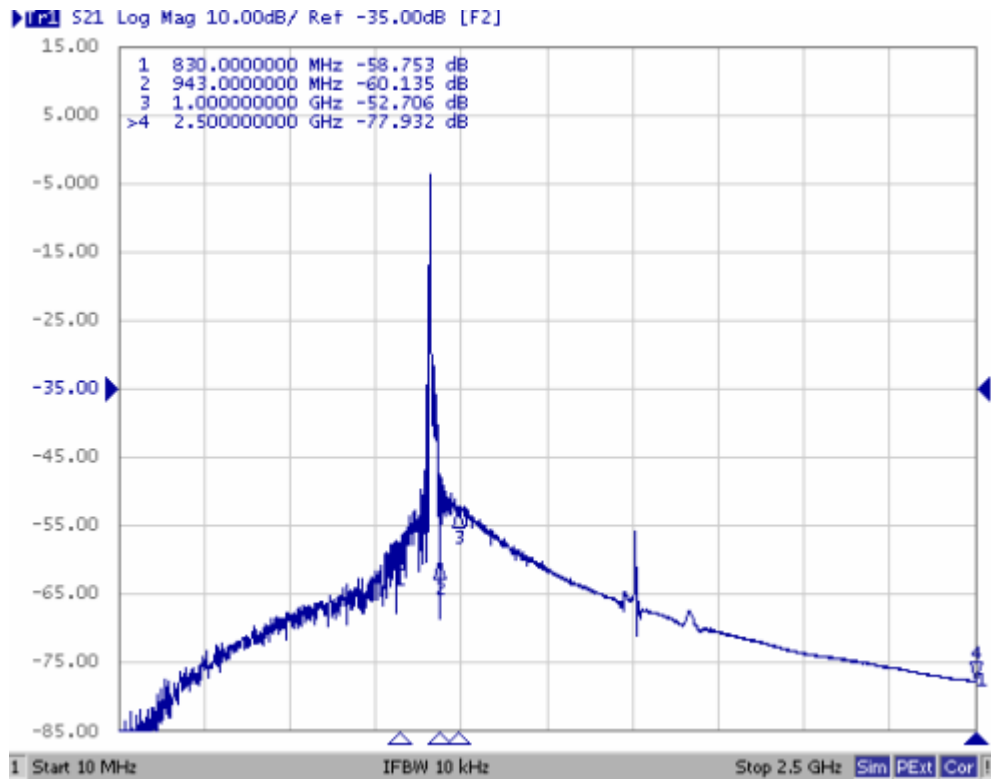

D. MEASUREMENT CIRCUIT:

The matching circuit is ideal by simulation

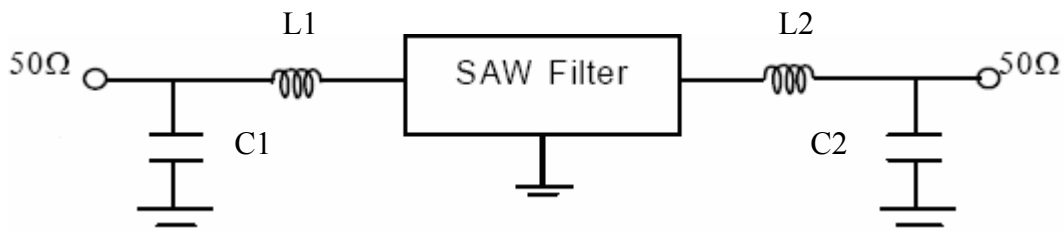

L1 : 34nH , L2 : 33nH (Ideal value)

C1 : 1.6 pF , C2 : 1.6pF (Ideal value)

E.OUTLINE DRAWING:

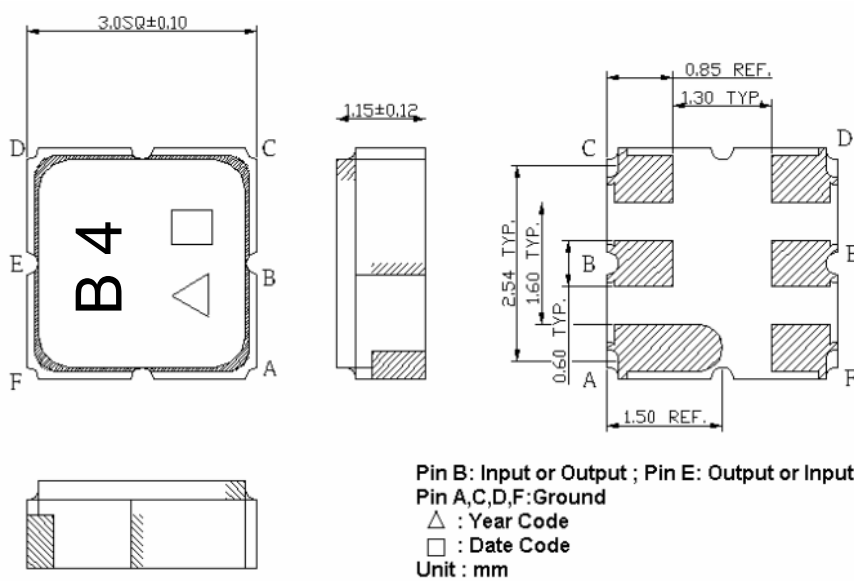

F. PCB Footprint:

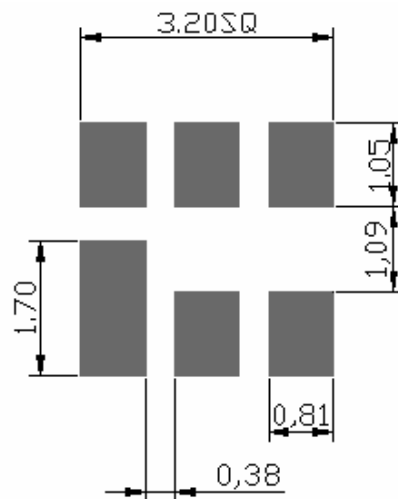

G. PACKING:

1. REEL DIMENSION

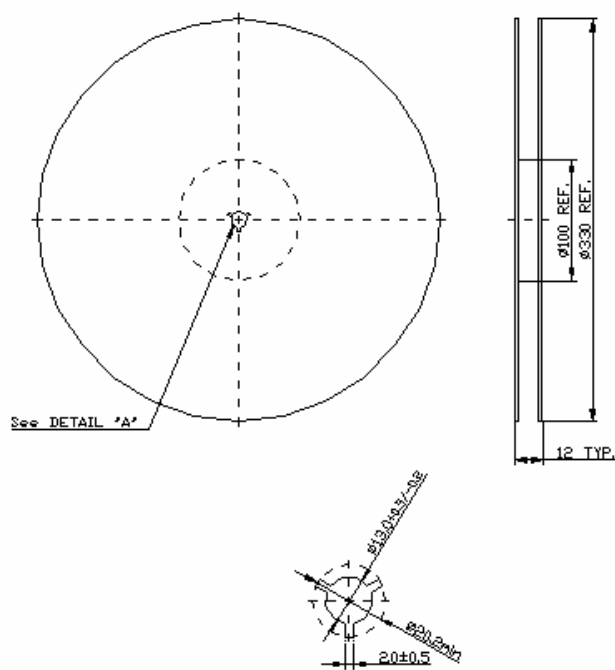

2. TAPE DIMENSION

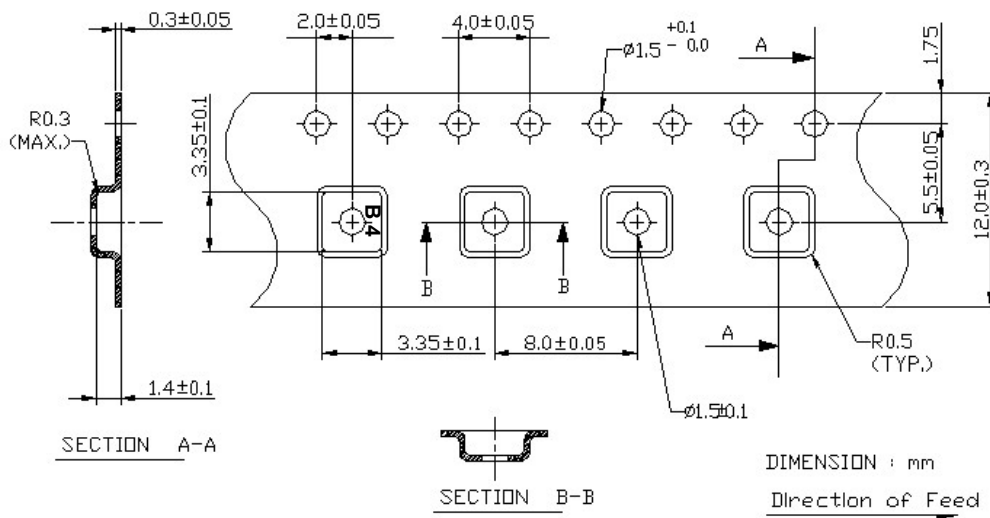

H. RECOMMENDED REFLOW PROFILE :

