



**PRELIMINARY**

**MG75HF12C1** RoHS COMPLIANT

## IGBT Modules

**V<sub>CES</sub>** 1200V  
**I<sub>C</sub>** 75A



### Applications

- Industrial Inverters
- Servo Applications
- SMPS UPS
- Induction Heating
- Welder

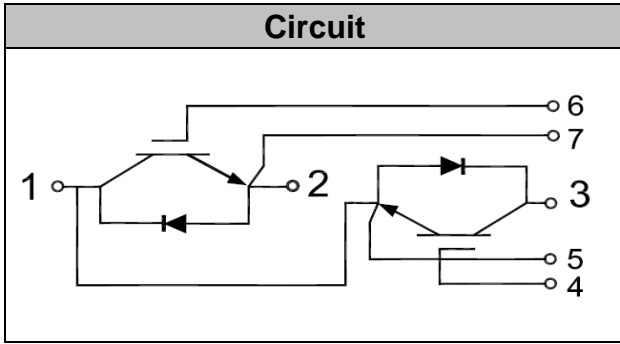

### Features

- Short Circuit Rated 10 $\mu$ s
- Low Stray Inductance
- Low Saturation Voltage
- Ultra Low loss
- HI-REL Power Terminals
- Lead Free, Compliant With RoHS Requirement

### Absolute Maximum Ratings (T<sub>C</sub> = 25

°C unless otherwise specified

Symbol	Description	Values	Units	
V <sub>CES</sub>	Collector - Emitter Voltage	1200	V	
V <sub>GES</sub>	Gate-Emitter Voltage	±20	V	
I <sub>C</sub>	DC Collector Current	T <sub>C</sub> =25°C	150	A
		T <sub>C</sub> =80°C	75	A
I <sub>CM(1)</sub>	Peak Collector Current Repetitive	T <sub>J</sub> = 125°C	150	A
I <sub>F</sub>	Diode Continuous Forward Current	T <sub>J</sub> = 125°C	75	A
I <sub>FM</sub>	Peak FWD Current Repetitive		150	A
t <sub>SC</sub>	Short Circuit Withstand Time		>10	μs
P <sub>D</sub>	Maximum Power Dissipation (IGBT)	T <sub>C</sub> = 25°C, T <sub>Jmax</sub> =150°C	625	W
T <sub>J</sub>	Maximum Junction Temperature		150	°C
T <sub>JOP</sub>	Operating Temperature		-40 ~ +150	°C
T <sub>stg</sub>	Storage Temperature		-40 ~ +125	°C
Viso	Isolation Voltage (All Terminals Shorted)	f=50Hz, 1min	3000	V
Mounting Torque	Power Terminals Screw:M5		5	N*m
	Mounting Screw:M6		6	N*m

Notes :

(1) Repetitive Rating: Pulse width limited by max. junction temperature



PRELIMINARY

MG75HF12C1 **RoHS**  
COMPLIANT

**Electrical Characteristics of IGBT** ( $T_J = 25$

) $^{\circ}$ C unless otherwise specified

Symbol	Item	Conditions	Values			Units
			Min.	Typ.	Max.	
<b>OFF Characteristics</b>						
$V_{(BR)CES}$	Collector-Emitter Breakdown Voltage	$V_{GE} = 0V, I_C = 1mA$	1200			V
$I_{CES}$	Collector Leakage Current	$V_{CE}=V_{CES}, V_{GE}=0V,$			100	$\mu A$
		$V_{CE}=V_{CES}, V_{GE}=0V,$ $T_J=125^{\circ}C$			1	mA
$I_{GES}$	Gate Leakage Current	$V_{CE}=0V, V_{GE}=\pm 20V$	-400		400	nA
<b>ON Characteristics</b>						
$V_{GE(th)}$	Gate - Emitter Threshold Voltage	$V_{CE}=V_{GE}, I_C=3mA$	5	6.2	7	V
$V_{CE(sat)}$	Collector – Emitter Saturation Voltage	$I_C=75A, V_{GE}=15V$		1.8		V
		$I_C=75A, V_{GE}=15V,$ $T_J=125^{\circ}C$		2		V
<b>Dynamic Characteristics</b>						
$C_{ies}$	Input Capacitance	$V_{CE} = 25V, V_{GE} = 0V,$ $f = 1MHz$		5.5		nF
$C_{oes}$	Output Capacitance			0.4		nF
<b>Switching Characteristics</b>						
$t_{d(on)}$	Turn-on Delay Time	$V_{CC} = 600V, I_C = 75A,$ $R_G = 15\Omega, V_{GE} = \pm 15V,$ Inductive Load, $T_J = 25^{\circ}C$		150		ns
$t_r$	Rise Time			70		ns
$t_{d(off)}$	Turn-off Delay Time			440		ns
$T_f$	Fall Time			60		ns
$E_{on}$	Turn-on Switching Loss			7.45		mJ
$E_{off}$	Turn-off Switching Loss			4.9		mJ
$t_{d(on)}$	Turn-on Delay Time	$V_{CC} = 600V, I_C = 75A,$ $R_G = 15\Omega, V_{GE} = \pm 15V,$ Inductive Load, $T_J = 125^{\circ}C$		160		ns
$t_r$	Rise Time			65		ns
$t_{d(off)}$	Turn-off Delay Time			500		ns
$T_f$	Fall Time			70		ns
$E_{on}$	Turn-on Switching Loss			10.3		mJ
$E_{off}$	Turn-off Switching Loss			7.8		mJ
$Q_{ge}$	Gate Charge	$V_{CC}=600V, I_C=75A,$ $V_{GE}=\pm 15V$		780		nC
RBSOA	Reverse Bias Safe Operating Area	$I_C = 150A, V_{CC} = 600V,$ $V_p = 1200V, R_g = 15\Omega,$ $V_{GE} = +15V$ to $0V,$ $T_J = 150^{\circ}C$	Trapezoid			
SCSOA	Short Circuit Safe Operating Area	$V_{CC} = 600V, V_{GE} = 15V,$ $T_J = 150^{\circ}C$	10			$\mu s$



**Electrical Characteristics of FWD** ( $T_C = 25$

$^{\circ}\text{C}$  unless otherwise specified

Symbol	Item	Conditions	Values			Units
			Min.	Typ.	Max.	
$V_{FM}$	Forward Voltage	$I_F = 75\text{A}, V_{GE} = 0\text{V}$	$T_J = 25^{\circ}\text{C}$		2	V
			$T_J = 125^{\circ}\text{C}$		1.7	
$t_{rr}$	Reverse Recovery Time	$I_F = 75\text{A},$ $di/dt = 1400\text{A}/\mu\text{s},$ $V_{rr} = 600\text{V},$ $V_{GE} = -15\text{V}$	$T_J = 25^{\circ}\text{C}$		160	ns
			$T_J = 125^{\circ}\text{C}$		200	
$I_{rr}$	Peak Reverse Recovery Current		$T_J = 25^{\circ}\text{C}$		55	A
			$T_J = 125^{\circ}\text{C}$		70	
$Q_{rr}$	Reverse Recovery Charge	$T_J = 25^{\circ}\text{C}$		5.3	$\mu\text{C}$	
		$T_J = 125^{\circ}\text{C}$		8.2		

**Thermal Resistance Characteristics**

Symbol	Description	Values			Units
		Min.	Typ.	Max.	
$R_{\theta JC}$	Junction-To-Case (IGBT Part, Per Leg)			0.2	$^{\circ}\text{C}/\text{W}$
$R_{\theta JC}$	Junction-To-Case (Diode Part, Per Leg)			0.5	$^{\circ}\text{C}/\text{W}$
$R_{\theta CS}$	Case-To-Sink (Conductive Grease Applied)			0.1	$^{\circ}\text{C}/\text{W}$
M	Power Terminals Screw:M5		3	5	N·m
M	Mounting Screw:M6		4	6	N·m
Weight	Weight Of Module		150	160	g

**Performance Curves**

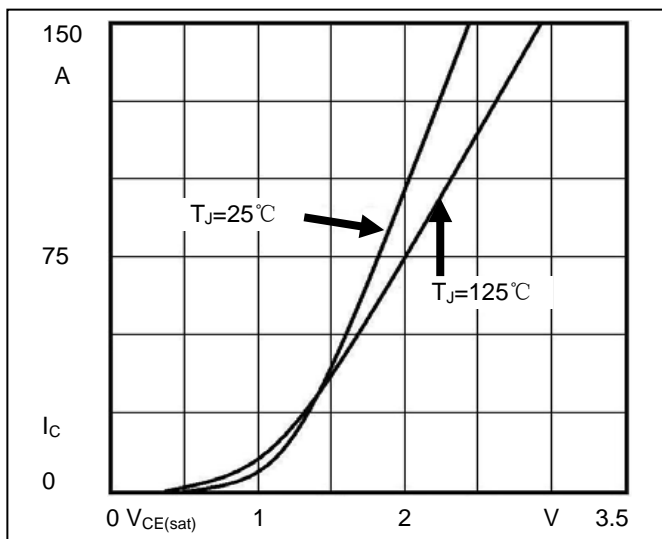

**Fig1. Typical Output Characteristics**

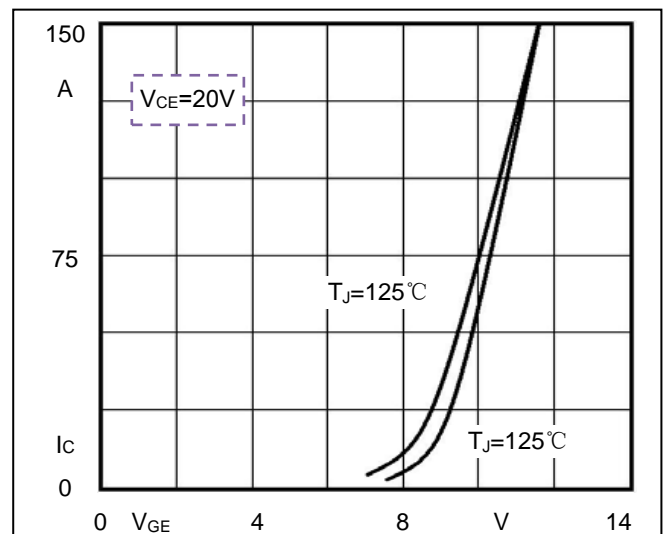

**Fig2. Typical Transfer Characteristics**

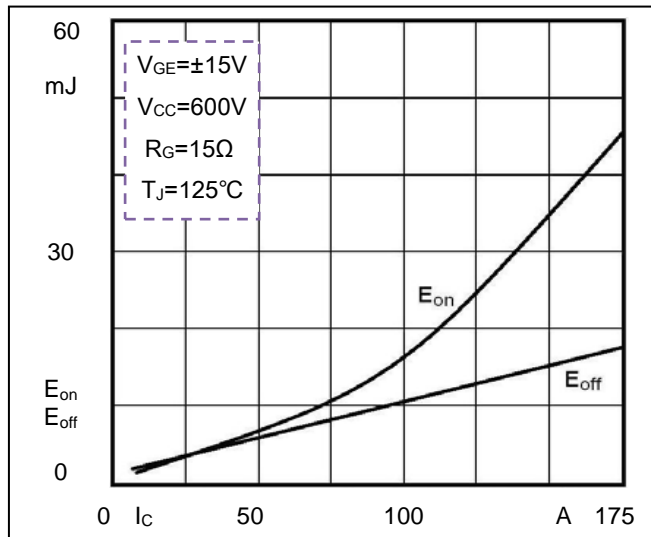

Fig3. Switching Energy vs. Collector Current

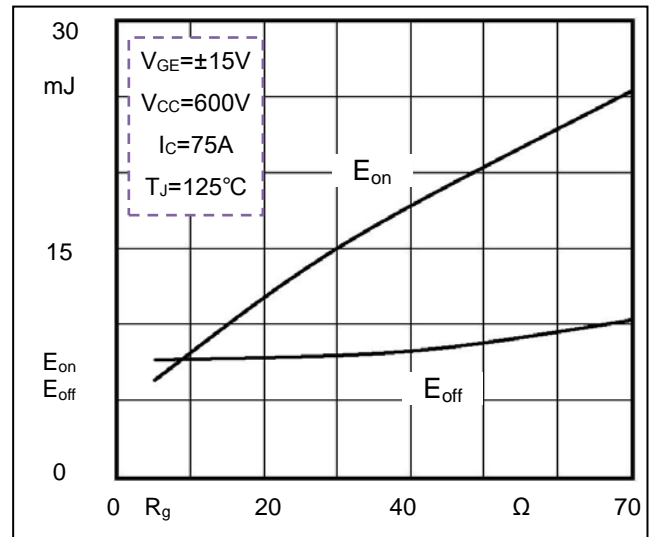

Fig4. Switching Energy vs. Gate Resistor

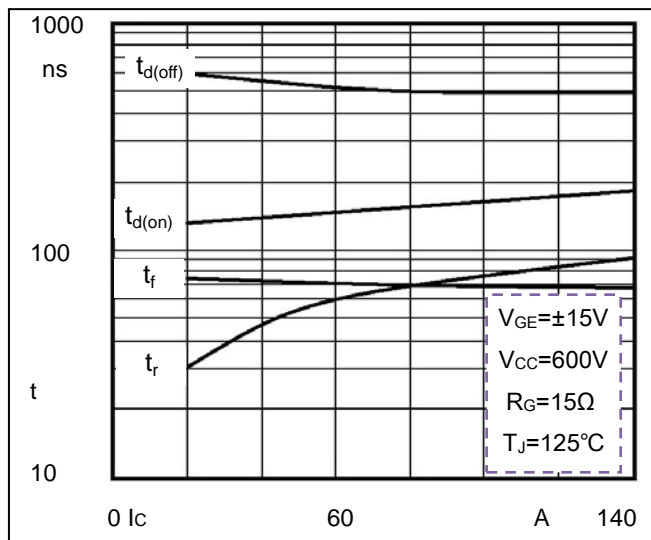

Fig5. Switching Times vs. Collector Current

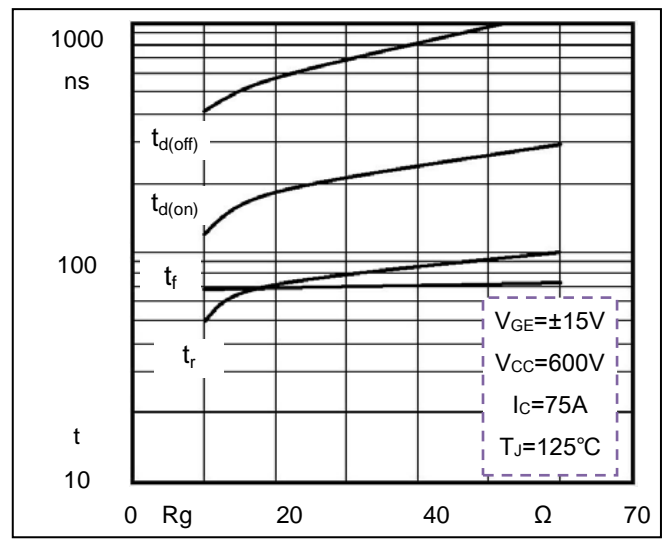

Fig6. Switching Times vs. Gate Resistor

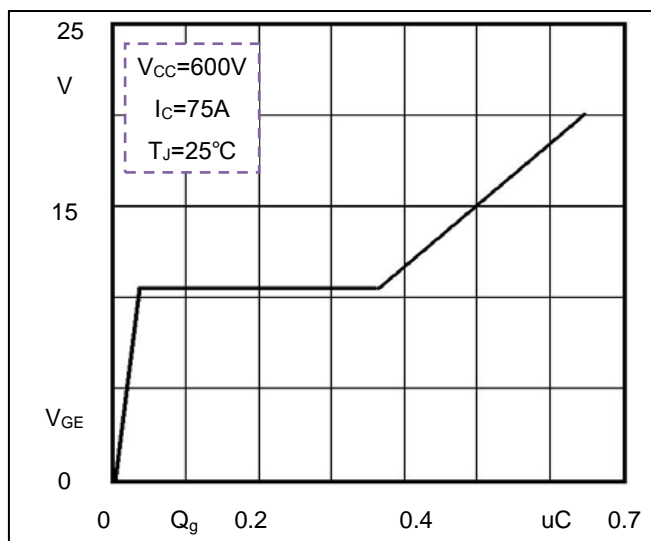

Fig7. Gate Charge characteristics

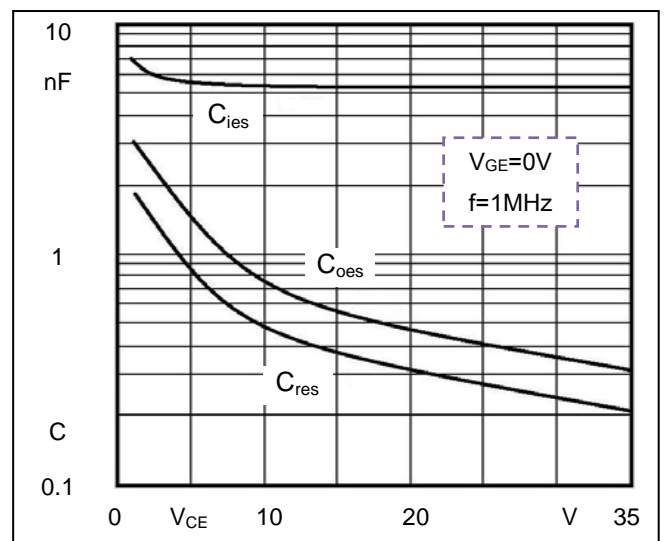

Fig8. Typical Capacitances vs.  $V_{CE}$

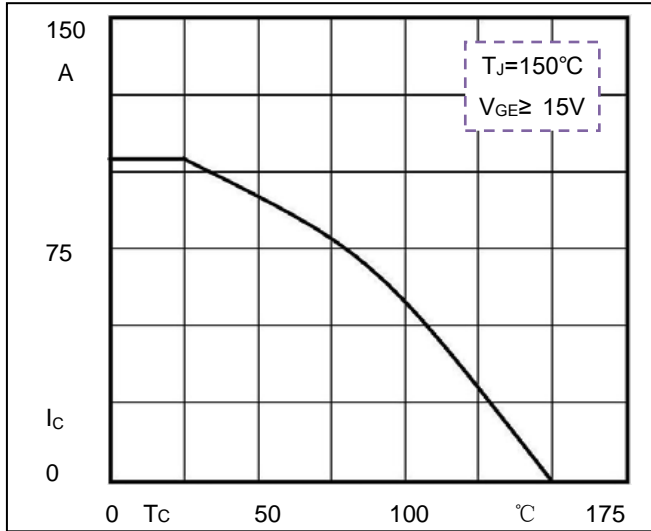

Fig9. Rated Current vs.  $T_c$

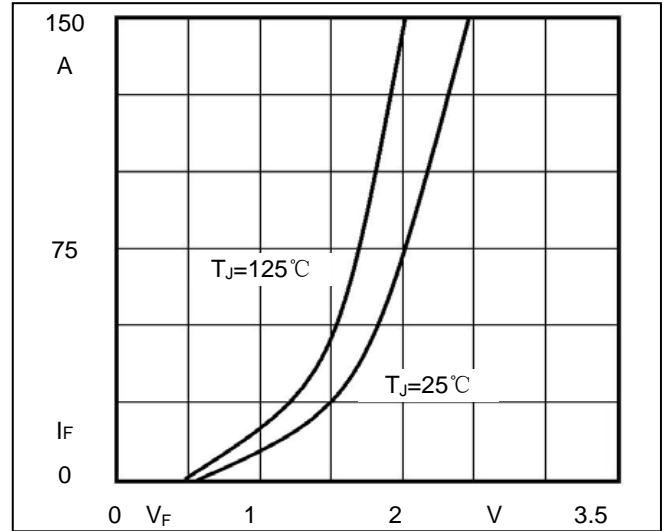

Fig10. Diode Forward Characteristics

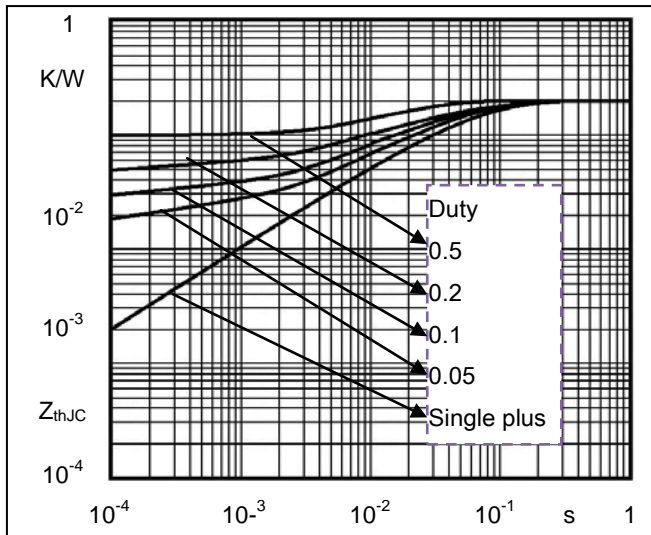

Fig11. Transient Thermal Impedance of IGBT

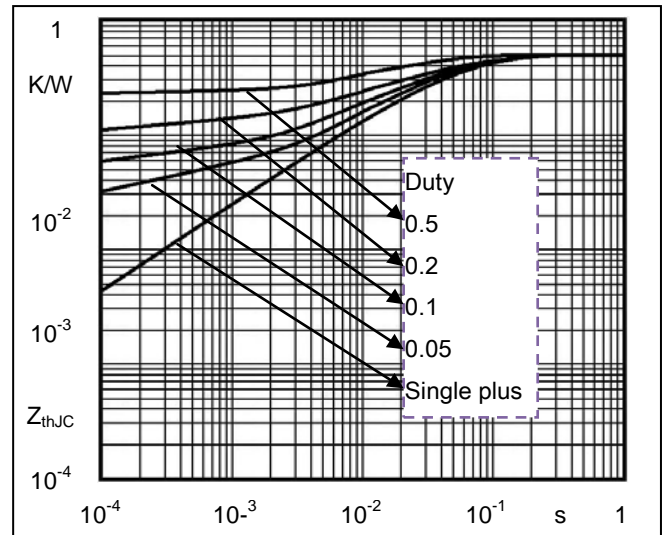

Fig12. Transient Thermal Impedance of Diode



PRELIMINARY

MG75HF12C1 RoHS COMPLIANT

Package Outline Information

CASE: C1

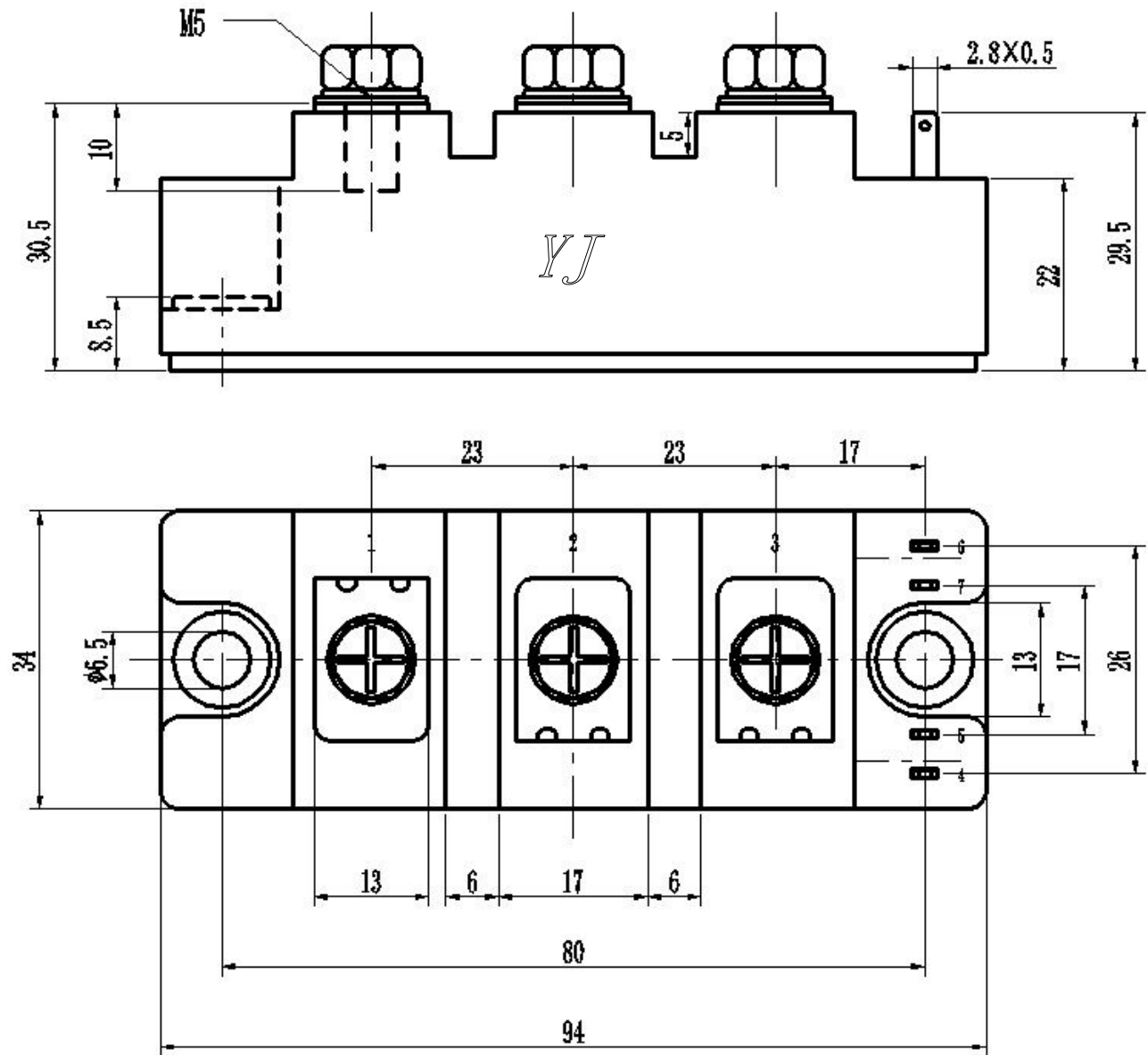

Dimensions in mm