



2016-V1.0-0720-C

Specifications

LED Power Supplies for Outdoor Use

LGEU-250CV Series, 250W

PAIRUI ELECTRONICS

No. 545 Museum Road
Yangzhou, Jiangsu
China 225009

Tel: 86 (514) 8279 1592

Fax: 86 (514) 8769 3159

2016

LED Power Supplies for Outdoor Use

LGEU-250CV SERIES, 250WATT, IP65 RATING

Features

- 5 Year Warranty
- Universal Input Voltage Range: 90~305Vac
- Constant Current & Constant Voltage Mode
- Adjustable Output Current 60%~100%
- High PF up to 0.98
- Rating IP65, Suitable for Outdoor Applications
- All Round Protections: Short Circuit, Over Voltage, Over Current, Over Temperature
- 3 in 1 Dimming(0-10V/Resistor/PWM)



Applications

- ✓ Street Light
- ✓ Tunnel Light
- ✓ Flood Light
- ✓ Refrigeration Equipment
- ✓ Other Light Fixtures for Outdoor Use

Electrical

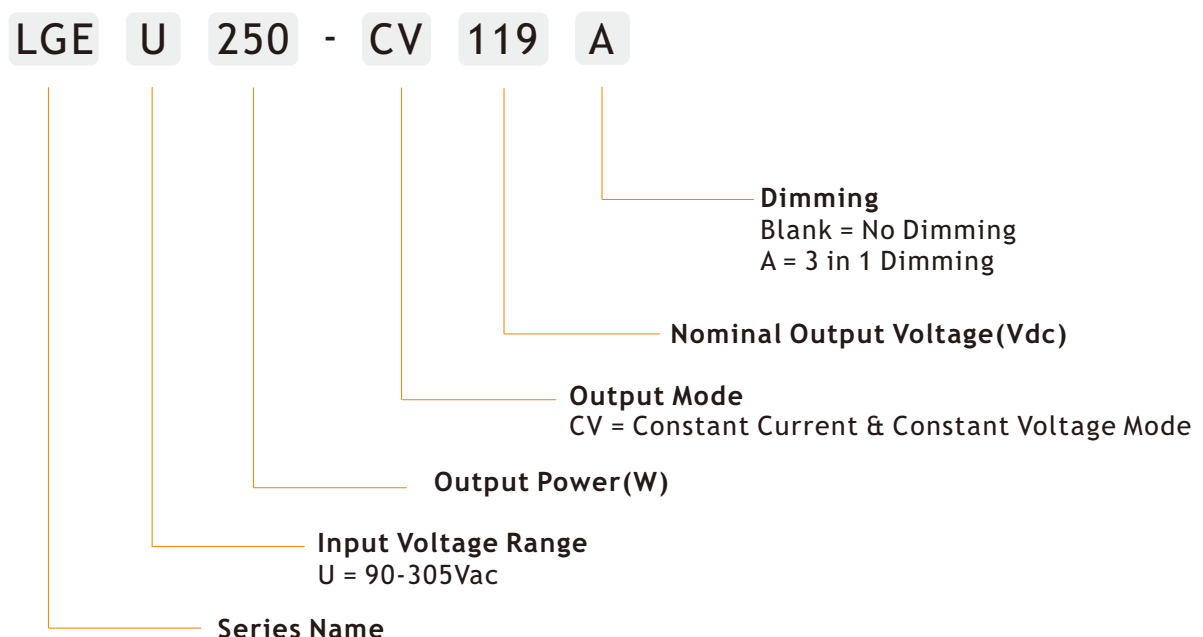

Electrical

Part Number	Nominal Input Voltage	Nominal Output Voltage & Current	Constant Current Range	Output Voltage Adjustable Range	Output Current Adjustable Range	Ripple	Efficiency	Certificate
LGEU250-CV179	100-277VAC	179V 1400mA	143-179VDC	171-188VDC	800-1400mA	5%	93.5%	CE
LGEU250-CV143	100-277VAC	143V 1800mA	114-143VDC	136-150VDC	1100-1800mA	5%	93.5%	CE
LGEU250-CV119	100-277VAC	119V 2100mA	95-119VDC	113-125VDC	1200-2100mA	5%	93.5%	CE
LGEU250-CV102	100-277VAC	82V 2500mA	82-102VDC	97-107VDC	1500-2500mA	5%	93.5%	CE
LGEU250-CV89	100-277VAC	89V 2800mA	71-89VDC	85-94VDC	1700-2800mA	5%	93.5%	CE
LGEU250-CV79	100-277VAC	79V 3200mA	63-79VDC	75-83VDC	1900-3200mA	5%	93.5%	CE
LGEU250-CV72	100-277VAC	72V 3500mA	58-72VDC	68-76VDC	2100-3500mA	5%	93.5%	CE
LGEU250-CV60	100-277VAC	60V 4200mA	48-60VDC	54-66VDC	2500-4200mA	5%	93%	CE
LGEU250-CV50	100-277VAC	50V 5000mA	40-50VDC	45-50VDC	3000-5000mA	5%	93%	CE

NOTE:

1. Other output models are may available on request;
2. Add suffix "A" for 3 in 1 dimming(0-10V/Resistor/PWM).

INPUT

PARAMETER	CONDITIONS	MIN	TYP	MAX	UNITS
Input voltage		90		305	Vac
Input frequency		47		63	Hz
Input current	Full load, Vin=110Vac Full load, Vin=220Vac		2.8 1.4		A A
Inrush current	Cold start, Vin=230Vac			65	A
Power factor(PF)	Full load, Vin=110Vac Full load, Vin=220Vac		0.98 0.97		
Leakage current	Vin=230Vac, 50Hz		0.75		mA
Surge voltage	L-N L, N-FG		4 6		KV KV

OUTPUT

PARAMETER	CONDITIONS	MIN	TYP	MAX	UNITS
Output voltage adjustable range				±10	%
Output current adjustable range		60		100	%
Output current accuracy			5		%
Line regulation	Vin from 100Vac to 277Vac		1		%
Load regulation	Vout from min. to max.		3		%
Output current overshoot	Turning on			10	%
Turn-on delay time	Cold start, power on		1000		ms
Ripple	Please refer to below measurement method		5%Io		mAp-p
THD	Output load≥50%			20	%

NOTE: The values are measured at 20MHz of bandwidth by using a 12'' twisted pair-wire terminated with 0.1uF & 47uF parallel capacitor under ambient temperature 25°C at rated input voltage and rated load.

Protection

Short circuit	In hiccup mode, it will recover automatically after fault condition is removed
Over voltage	110-150% Vout, the driver shall return to normal operation after the power is turn-on again
Over current	In hiccup mode, it will recover automatically after fault condition is removed
Over temperature	In hiccup mode, it will recover automatically after fault condition is removed

Environment

PARAMETER	CONDITIONS	MIN	TYP	MAX	UNITS
Ambient operating temperature	Startup at rated voltage	-35		+70	°C
Operating relative humidity	Non condensing	10		95	%
Storage temperature	Humidity 5 ~ 100% RH	-40		+85	°C
Maximum case temperature	Hot-spot on case			+90	°C
MTBF	Full load, 220Vac input, 25°C ambient temperature	200			Khrs
Waterproof rating	IP65				
Dimension(LxWxH)	244.0 x 68.0 x 38.8mm				
Weight	1200g				

Safety/EMC

Safety	Design refer to UL8750, UL935, UL1012, UL1310 Class 2, EN61347, EN61347-2-13
EMC	Compliance to EN55015, FCC Part 15 Class B, EN61000-3-2, EN61000-3-3, EN61000-4-2, 3, 4, 6, 8, 11, EN61547

NOTE: Unless otherwise specified, all the above parameters are measured at ambient temperature of 25°C and Vin=100Vac to 277Vac.

Mechanical

No Dimming

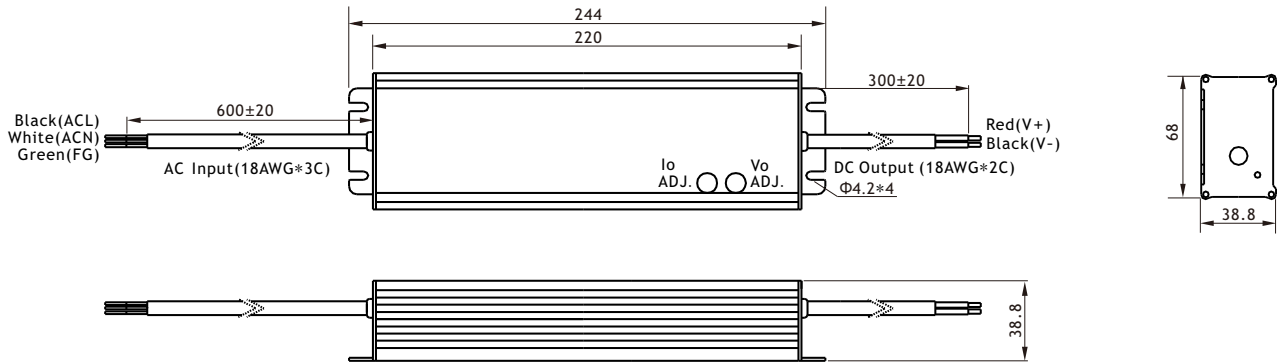

3 in 1 Dimming

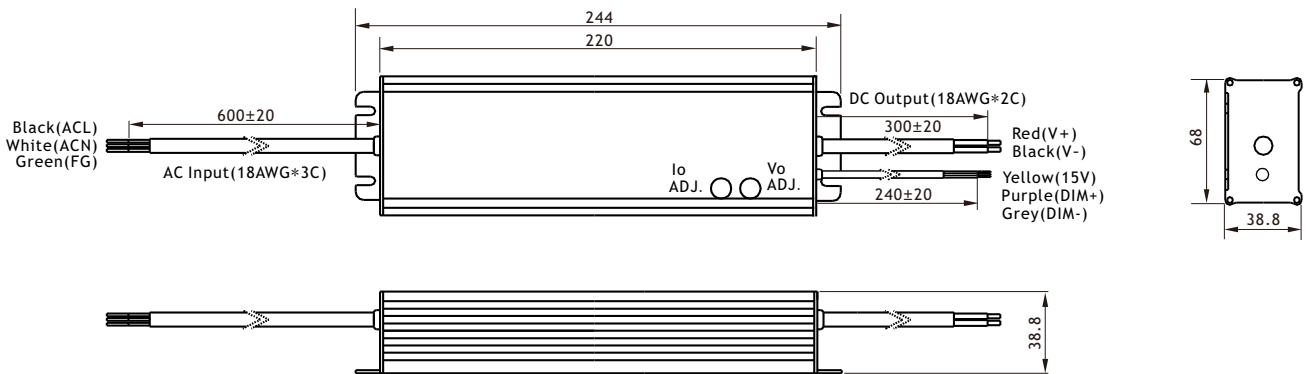

Electrical Curve

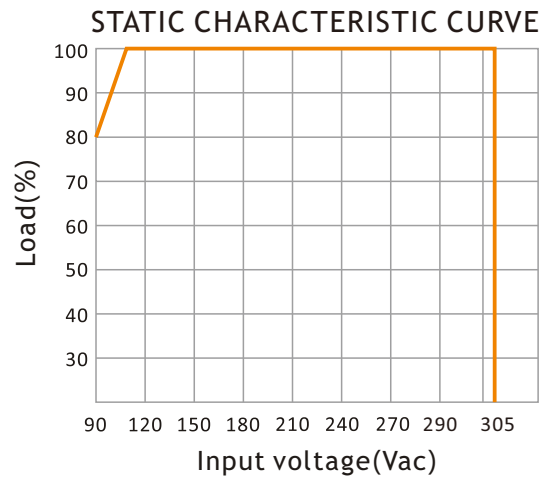
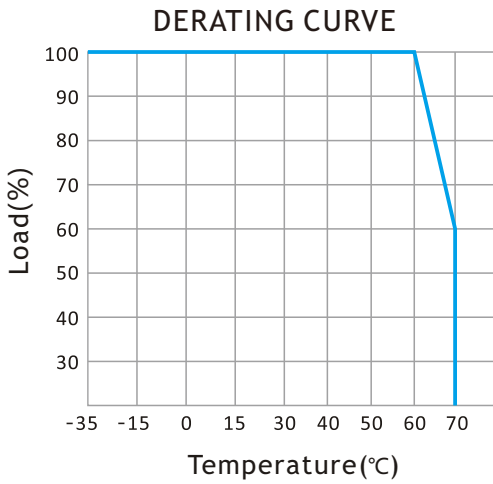

Dimming Function

0-10V Dimming

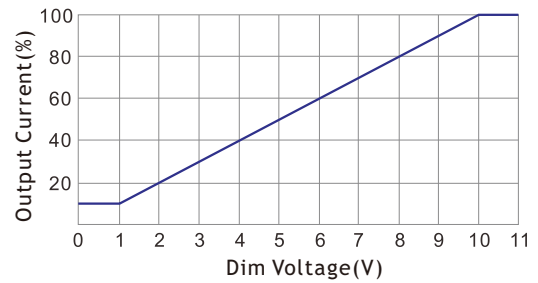
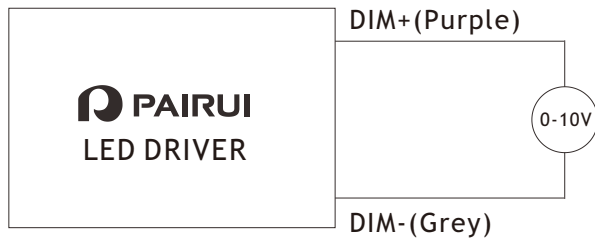

External Resistor Dimming

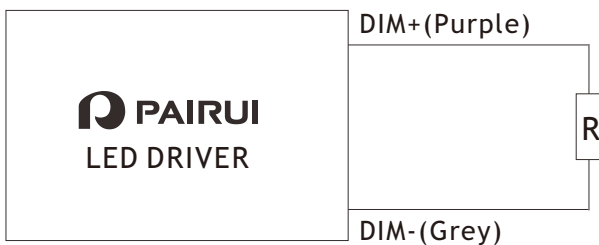

Dimming Function

PWM Dimming

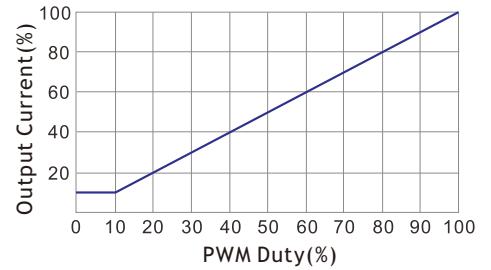
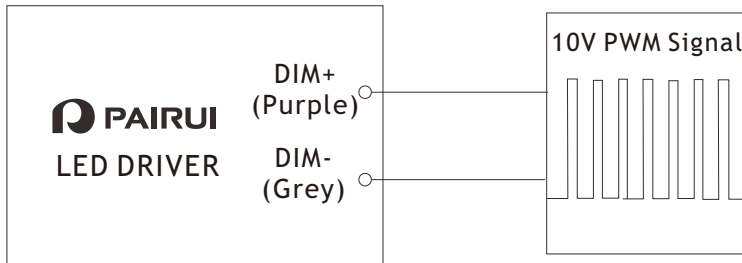

Package

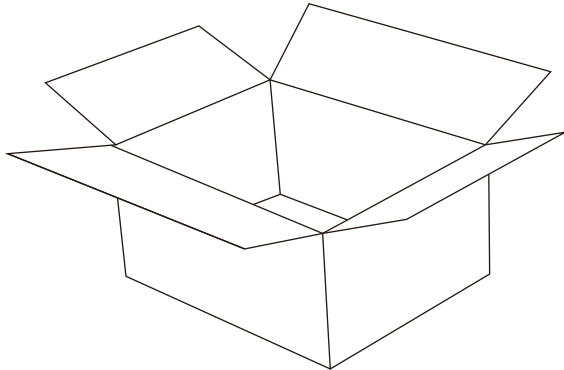



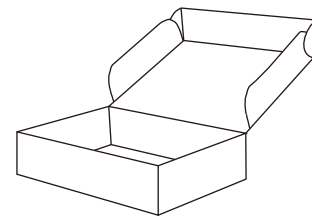



Outer Carton
L 620 x W 260 x H 185mm













Inner Box
L 265 x W 102.5 x H 46mm

SERIES	QTY/BOX	QTY/CARTON	NET WEIGHT	GROSS WEIGHT	VOLUME
LGEU-250CV	1 piece	12 boxes	14.4kg/carton	16kg/carton	0.03CBM/carton

Labelling

<p>INPUT</p> <ul style="list-style-type: none"> • ACL (BLK) • ACN (WHT) • ⊕ (GRN) 	 <p>PAIRUI LGEU250-CV48 LED POWER SUPPLY INPUT: 100-277VAC, 50/60Hz OUTPUT: 3100-5200mA, 39-48VDC MADE IN CHINA</p>	<p>• ta 70°C • tc 90°C</p> <p>   IP65   </p>	<p>OUTPUT</p> <ul style="list-style-type: none"> • DC+ (RED) • DC- (BLK) <p>   IO ADJ VO ADJ </p>
---	--	---	--

<p>INPUT</p> <ul style="list-style-type: none"> • ACL (BLK) • ACN (WHT) • ⊕ (GRN) 	 <p>PAIRUI LGEU250-CV48A LED POWER SUPPLY INPUT: 100-277VAC, 50/60Hz OUTPUT: 3100-5200mA, 39-48VDC MADE IN CHINA (3 in 1 Dimming)</p>	<p>• ta 70°C • tc 90°C</p> <p>   IP65   </p>	<p>OUTPUT</p> <ul style="list-style-type: none"> • DC+ (RED) • DC- (BLK) • 15V (YEL) • DIM+ (PPL) • DIM- (GRY) <p>   IO ADJ VO ADJ </p>
---	---	---	---

Symbol	Description
	Short-circuit-proof with safety insulation
	Independent Operation
IP65	Type of protection(IP65 for indoor and outdoor use)
	RoHS Mark
	CE Mark