



**CM1000E3U-34NF**  
**Mega Power Chopper IGBTMOD™**  
 1000 Amperes/1700 Volts

**Absolute Maximum Ratings,  $T_j = 25^\circ\text{C}$  unless otherwise specified**

Ratings	Symbol	CM1000E3U-34NF	Units
Junction Temperature	$T_j$	-40 to 150	$^\circ\text{C}$
Storage Temperature <sup>*7</sup>	$T_{\text{stg}}$	-40 to 125	$^\circ\text{C}$
Collector-Emitter Voltage (G-E SHORT)	$V_{\text{CES}}$	1700	Volts
Gate-Emitter Voltage (C-E SHORT)	$V_{\text{GES}}$	$\pm 20$	Volts
Collector Current DC ( $T_C = 104^\circ\text{C}$ ) <sup>*6</sup>	$I_C$	1000	Amperes
Peak Collector Current (Pulse) <sup>*2</sup>	$I_{\text{CM}}$	2000	Amperes
Emitter Current ( $T_C = 25^\circ\text{C}$ ) <sup>*4</sup>	$I_E^{*1}$	75	Amperes
Peak Emitter Current (Pulse) <sup>*2</sup>	$I_{\text{EM}}^{*1}$	150	Amperes
Maximum Collector Dissipation ( $T_C = 25^\circ\text{C}$ ) <sup>*2,4</sup>	$P_C$	3900	Watts
Mounting Torque, M6 Mounting Screws (Max.)	–	40	in-lb
Mounting Torque, M6 Main Terminal Screw (Max.)	–	40	in-lb
Weight (Typical)	–	1400	Grams
Isolation Voltage (Main Terminal to Baseplate, AC 1 min.)	$V_{\text{iso}}$	3500	$V_{\text{rms}}$

**Clamp Diode Part,  $T_j = 25^\circ\text{C}$  unless otherwise specified**

Repetitive Peak Reverse Voltage	$V_{\text{RRM}}$	1700	Volts
Forward Current ( $T_C = 25^\circ\text{C}$ ) <sup>*4</sup>	$I_F$	1000	Amperes
Peak Forward Current (Pulse) <sup>*2</sup>	$I_{\text{FM}}$	2000	Amperes

\*1  $I_E$ ,  $I_{EM}$ , and  $V_{EC}$  represent ratings and characteristics of the anti-parallel, emitter-to-collector free-wheel diode (FWDi).

\*2 Pulse width and repetition rate should be such that device junction temperature ( $T_j$ ) does not exceed  $T_{j(\text{max})}$  rating.

\*4 Case temperature ( $T_C$ ) is baseplate side.

\*6 Case temperature ( $T_C$ ) and heatsink temperature ( $T_f$ ) measured point is just under the chips.

\*7 The operation temperature is restrained by the permission temperature of female connector housing.

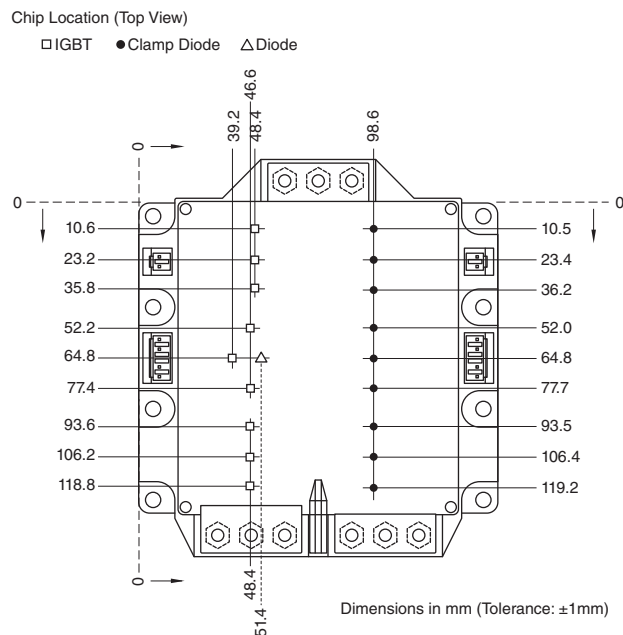



Powerex, Inc., 173 Pavilion Lane, Youngwood, Pennsylvania 15697 (724) 925-7272

**CM1000E3U-34NF**

**Mega Power Chopper IGBTMOD™**

1000 Amperes/1700 Volts

**Electrical Characteristics,  $T_j = 25^\circ\text{C}$  unless otherwise specified**

Characteristics	Symbol	Test Conditions	Min.	Typ.	Max.	Units
Collector-Cutoff Current	$I_{CES}$	$V_{CE} = V_{CES}, V_{GE} = 0V$	–	–	1	mA
Gate Leakage Current	$I_{GES}$	$V_{GE} = V_{GES}, V_{CE} = 0V$	–	–	0.5	$\mu\text{A}$
Gate-Emitter Threshold Voltage	$V_{GE(th)}$	$I_C = 100\text{mA}, V_{CE} = 10V$	5.5	7	8.5	Volts
Collector-Emitter Saturation Voltage (Without Lead Resistance)	$V_{CE(sat)}$ (Chip)	$I_C = 1000\text{A}, V_{GE} = 15V, T_j = 25^\circ\text{C}^{*3}$ $I_C = 1000\text{A}, V_{GE} = 15V, T_j = 125^\circ\text{C}^{*3}$	–	2.2 2.45	2.8 –	Volts
Module Lead Resistance	$R_{(lead)}$	$I_C = 1000\text{A}, \text{Terminal-Chip}$	–	0.286	–	$\text{m}\Omega$
Input Capacitance	$C_{ies}$		–	–	220	nF
Output Capacitance	$C_{oes}$	$V_{CE} = 10V, V_{GE} = 0V$	–	–	25	nF
Reverse Transfer Capacitance	$C_{res}$		–	–	4.7	nF
Total Gate Charge	$Q_G$	$V_{CC} = 1000V, I_C = 1000\text{A}, V_{GE} = 15V$	–	6000	–	nC
Turn-on Delay Time	$t_{d(on)}$	$V_{CC} = 1000V, I_C = 1000\text{A},$	–	–	600	ns
Turn-on Rise Time	$t_r$	$V_{GE} = \pm 15V,$	–	–	150	ns
Turn-off Delay Time	$t_{d(off)}$	$R_G = 0.47\Omega,$	–	–	900	ns
Turn-off Fall Time	$t_f$	Inductive Load	–	–	200	ns
Emitter-Collector Voltage <sup>*1</sup>	$V_{EC}$	$I_E = 75\text{A}, V_{GE} = 0V^{*3}$	–	–	2.8	Volts
External Gate Resistance	$R_G$		0.47	–	4.7	$\Omega$

**Clamp Diode Characteristics,  $T_j = 25^\circ\text{C}$  unless otherwise specified**

Characteristics	Symbol	Test Conditions	Min.	Typ.	Max.	Units
Repetitive Peak Reverse Current	$I_{RRM}$	$V_R = V_{RRM}$	–	–	1	mA
Forward Voltage	$V_{FM}$	$I_F = 1000\text{A}^{*3}$	–	–	3.0	Volts
Reverse Recovery Time	$t_{rr}$	$I_F = 1000\text{A}$	–	–	450	ns
Reverse Recovery Charge	$Q_{rr}$	$I_F = 1000\text{A}$	–	90	–	$\mu\text{C}$

**Thermal and Mechanical Characteristics,  $T_j = 25^\circ\text{C}$  unless otherwise specified**

Characteristics	Symbol	Test Conditions	Min.	Typ.	Max.	Units
Thermal Resistance, Junction to Case <sup>*4</sup>	$R_{th(j-c)Q}$	IGBT	–	–	0.032	$^\circ\text{C}/\text{W}$
Thermal Resistance, Junction to Case <sup>*4</sup>	$R_{th(j-c)D}$	Clamp	–	–	0.053	$^\circ\text{C}/\text{W}$
Thermal Resistance, Junction to Case <sup>*6</sup>	$R_{th(j-c')Q}$	IGBT	–	–	0.014	$^\circ\text{C}/\text{W}$
Thermal Resistance, Junction to Case <sup>*6</sup>	$R_{th(j-c')D}$	Clamp	–	–	0.023	$^\circ\text{C}/\text{W}$
Thermal Resistance, Junction to Case <sup>*4</sup>	$R_{th(c-f)D}$	Thermal Grease Applied per 1/2 Module <sup>*5</sup>	–	0.016	–	$^\circ\text{C}/\text{W}$
Contact Thermal Resistance <sup>*6</sup>	$R_{th(c-f)}$	Thermal Grease Applied per 1/2 Module <sup>*5</sup>	–	0.012	–	$^\circ\text{C}/\text{W}$

<sup>\*1</sup>  $I_E$ ,  $I_{EM}$ , and  $V_{EC}$  represent ratings and characteristics of the anti-parallel, emitter-to-collector free-wheel diode (FWDi).

<sup>\*3</sup> Pulse width and repetition rate should be such as to cause negligible temperature rise.

<sup>\*4</sup> Case temperature ( $T_C$ ) is baseplate side.

<sup>\*5</sup> Typical value is measured by using thermally conductive grease of  $\lambda = 0.9 \text{ [W/(m} \cdot \text{K)]}$ .

<sup>\*6</sup> Case temperature ( $T_C$ ) and heatsink temperature ( $T_f$ ) measured point is just under the chips.



Powerex, Inc., 173 Pavilion Lane, Youngwood, Pennsylvania 15697 (724) 925-7272

**CM1000E3U-34NF**  
**Mega Power Chopper IGBTMOD™**  
 1000 Amperes/1700 Volts

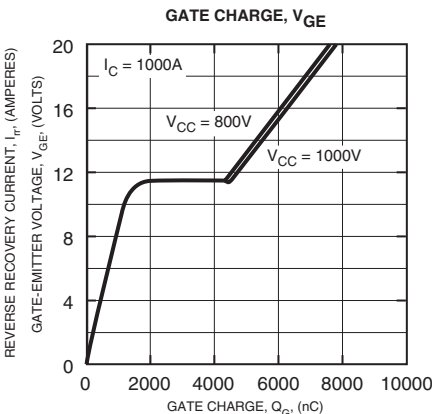
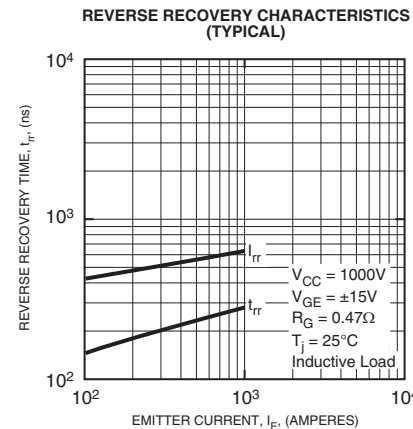
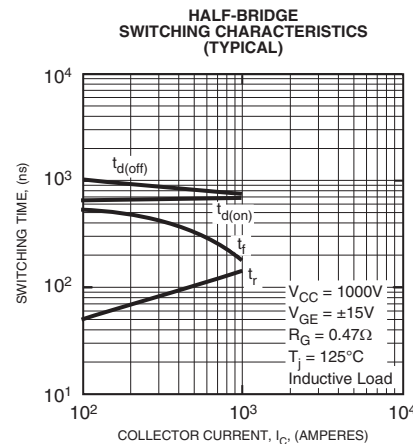
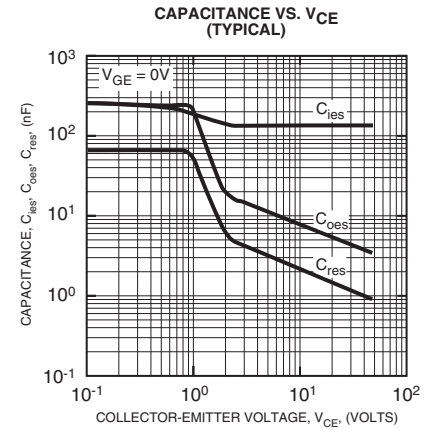
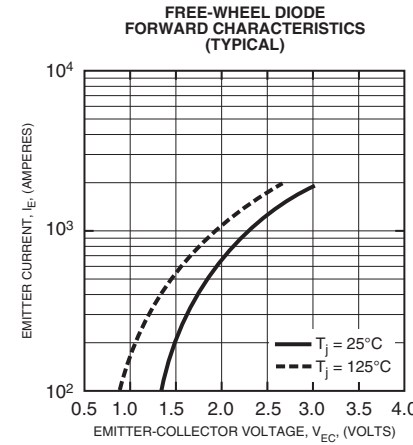
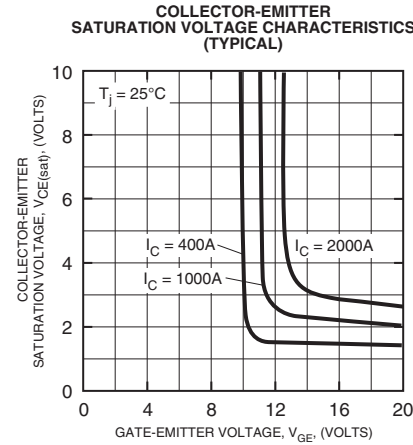
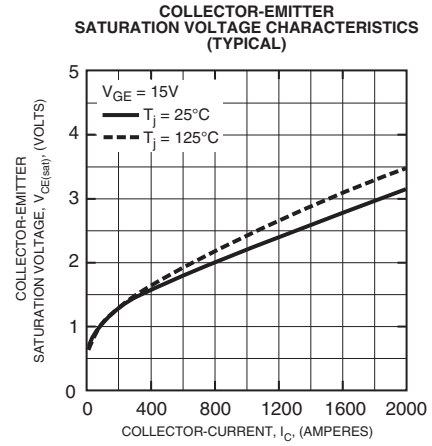
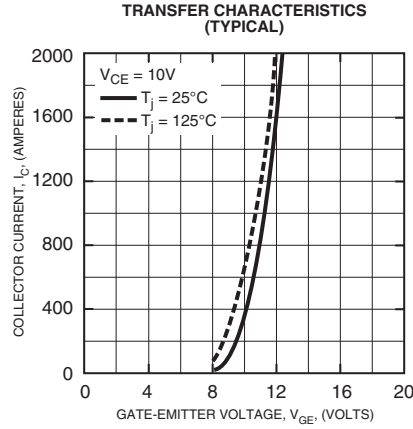
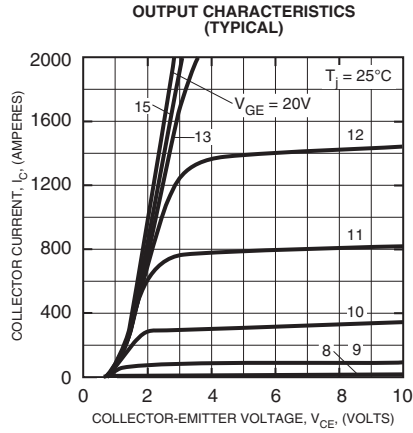

**CM1000E3U-34NF**  
**Mega Power Chopper IGBTMOD™**  
 1000 Amperes/1700 Volts

