

# Preliminary DATA SHEET

# 1310 NM FABRY-PEROT (FP) LASER DIODE PIGTAILED PACKAGE

FP-1310-5I-XXX

## FEATURES:

- Wide operating temperature (-40°C to 85°C)
- Stable threshold current for easy transmitter control ( $T_0 \sim 80K$ )
- 1310 nm typical emission wavelength FP-LDs
- Pigtailed package
- High-speed modulation capability (Up to 5Gb/s)
- Excellent reliability
  - ◆ Ultra-low gradual wear-out rates
  - ◆ <1% failures in 20 yrs at 55C

## APPLICATION

- Source for high-speed data-communication and telecommunication links
  - ◆ SONET, Fiber-channel, Giag-bit Ethernet, FTTX
  - ◆ CATV / Satellite and other analogue markets

The FP-1310-5I-xxx is an MOCVD grown InAlGaAs ridge laser diode with emission wave-length of 1310 nm and standard continuous light output of 5 mW per facet. These lasers provide stable, single transverse mode oscillation. These are hermetically sealed devices with an integrated monitor photodiode to monitor the optical output.

The TO-56 laser can is mounted inside a metal coaxial package which is then pigtailed with a singlemode fiber and terminated with a fiber connector. The pigtail comes in a choice of 50cm or 100cm lengths as standard, terminated with either FC or SC connectors with an APC or UPC polish.

Suitable as a light source for data-com and telecom applications with data rates up to 5 Gb/s.



Part Number	Description
FP-1310-5I-50SMF-FCUPC	1310 nm Fabry-Perot (FP) Laser Diode, 50cm singlemode pigtailed package, FC UPC connector.
FP-1310-5I-50SMF-FCAPC	1310 nm Fabry-Perot (FP) Laser Diode, 50cm singlemode pigtailed package, FC APC connector.
FP-1310-5I-100SMF-SCUPC	1310 nm Fabry-Perot (FP) Laser Diode, 100cm singlemode pigtailed package, SC UPC connector.
FP-1310-5I-100SMF-SCAPC	1310 nm Fabry-Perot (FP) Laser Diode, 100cm singlemode pigtailed package, SC APC connector.

Other fiber lengths and connector options available on request.

## ABSOLUTE MAXIMUM RATINGS

Symbol	Parameter	Conditions	Rating	Unit
$P_O$	Output power	CW	10	mW
$V_{RLD}$	Reverse voltage (laser diode)	-	2	V
$V_{RPD}$	Reverse voltage (monitor photodiode)	-	10	V
$I_{FPD}$	Forward current (photodiode)	-	1	mA
$T_C$	Operation temperature	-	-40 to +85	°C
$T_{stg}$	Storage temperature	-	-40 to +100	°C
-	ESD exposure level (human body model)	-	200	V

**NOTICE:** Stresses greater than those listed under “Absolute Maximum Ratings” may cause permanent damage to the device. This is a stress rating only and functional operation of the device at these or any other conditions above those indicated in the operations section for extended periods of time may affect reliability.

**NOTICE:** The inherent design of this component causes it to be sensitive to electrostatic discharge (ESD). To prevent ESD-induced damage and/or degradation to equipment, take normal ESD precautions when handling this product



## ELECTRICAL-OPTICAL CHARACTERISTICS

Unless otherwise stated, all parameters are at  $T_{CASE} = 25^{\circ}C$  and referenced to pigtail power.

Symbol	Parameter	Test Conditions	Minimum	Typical	Maximum	Unit
$P_{oc}$	Output power - pigtail end	CW, $I_F = 32mA$		2.5		mW
$I_{th}$	Threshold current	CW	3	9	15	mA
$I_{thH}$	Threshold current at $85^{\circ}C$	CW, $T_C=85^{\circ}C$		21	30	mA
$T_0$	Temperature dependence of threshold current		-	80	-	K
$I_{op}$	Operating current	For $P_O = 2mW$ (CW)	-	32		mA
$V_{op}$	Operating voltage	CW Voltage at $I_{op}$		1.15	1.4	V
$R_{op}$	Differential series resistance (laser diode)	CW $dV/dI$ at $T = 25^{\circ}C$ between 15 mA and 25 mA	4	7	12	$\Omega$
SE	Slope efficiency (fiber coupled)			0.1		W/A
SER	SE Ratio	SE @ $85^{\circ}C$ / SE @ $25^{\circ}C$	0.6	0.8		
		SE @ $40^{\circ}C$ / SE @ $25^{\circ}C$			1.4	
$\Delta SE/\Delta T$	Slope efficiency temperature coefficient			-0.35	-0.65	%/ $^{\circ}C$
$\lambda_c$	Lasing wavelength		1290	1310	1330	nm
$\Delta\lambda$	Spectral width under modulation	PRBS $2^7-1$ ER=10 dB; $I_b = 1.8 * I_{th}$ ; RMS (sigma)	-	1.5	2.75	nm
$d\lambda_c/dT$	Temperature dependence of lasing wavelength		0.40	0.45	0.55	nm/K
$t_r$	Rise time	20% - 80% ; $T_C = 85^{\circ}C$ ; ER = 10 dB; $I_b = 1.8 * I_{th}$	-	-	140	ps
$t_f$	Fall time	20% - 80% ; $T_C = 85^{\circ}C$ ; ER = 10 dB; $I_b = 1.8 * I_{th}$	-	-	140	ps
RIN	Relative Intensity Noise	CW, 0.95 to 5.45GHz, -20dBm back reflection in worst case polarization			-125	dB/Hz
TOIP	Third order intercept point	$P_O=2mW$ , F=5.45 to 5.452GHz, $85^{\circ}C$	15			dB
$f_R$	Relaxation oscillation frequency	$T_C = 85^{\circ}C$ ; $I = I_{th}+36$ mA	5	5.5	-	GHz
$C_d$	Capacitance for monitor photodiode		-	5	50	pF
$I_{mon}$	Monitor photodiode current	$I_{op} = 32mA$	30	130	1000	$\mu A$
$\Delta_{TRACK}$	Tracking error		-1.5	-	+1.5	dB
$I_{m0}$	Dark current for Monitor photodiode		-	-	0.1	$\mu A$

TYPICAL CHARACTERISTICS

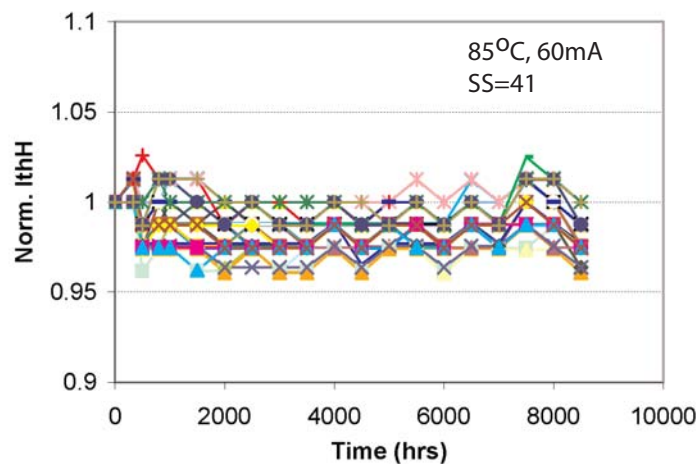
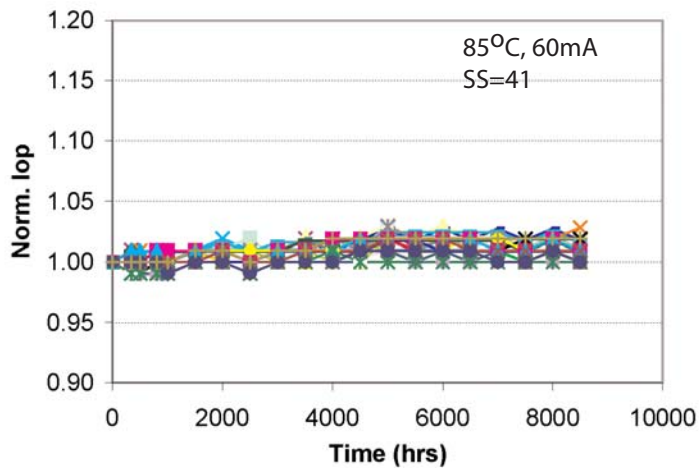

Typical LI curve at Tc = 25°C, 45°C, 65°C and 85°C

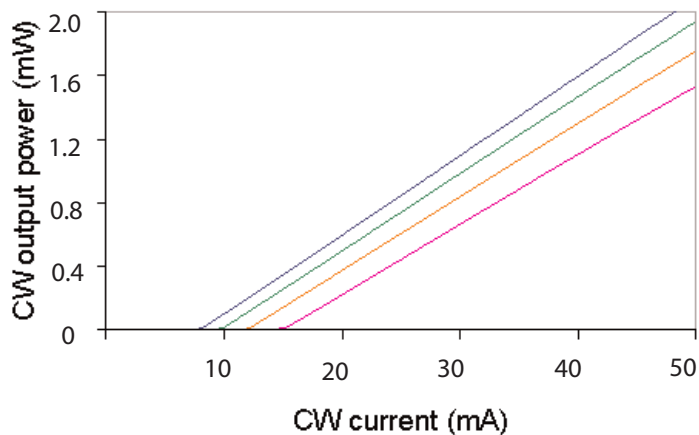

Typical IV curve at Tc = 25°C, 45°C, 65°C and 85°C

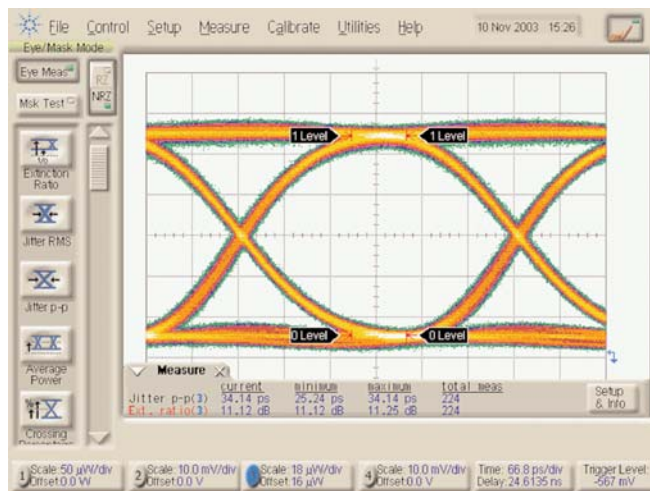
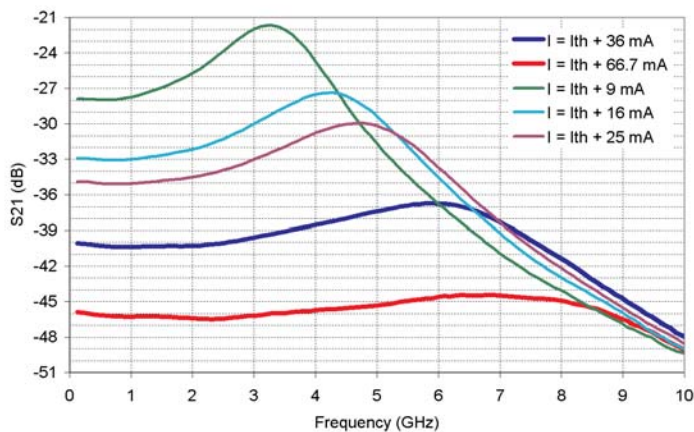
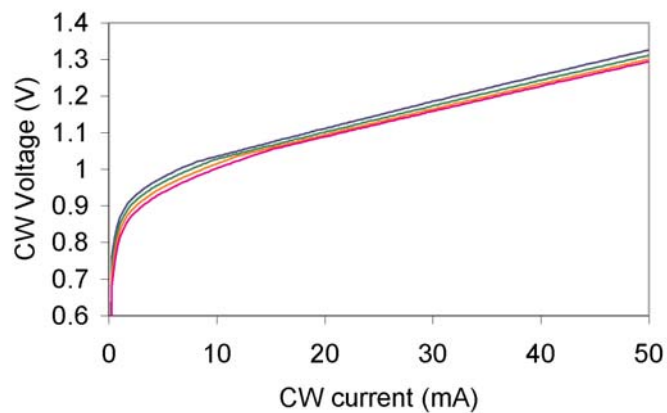

## TYPICAL CHARACTERISTICS

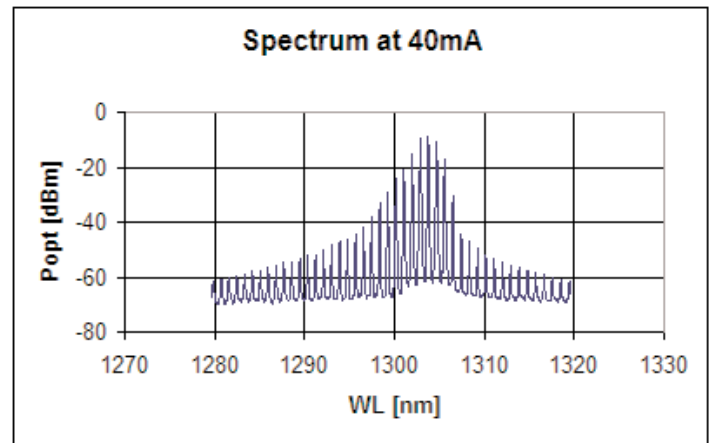
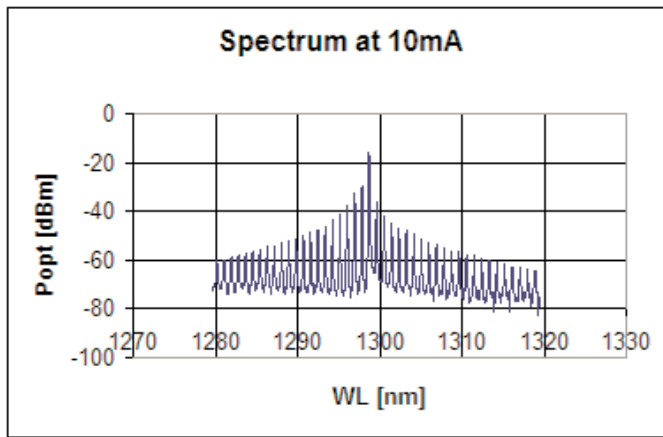

PIN OUT

Number	Function
1	Ground
2	LD Cathode
3	PD Anode
4	LD Anode / PD Cathode

MOUNTING DIMENSIONS

(for reference only): Dimensions in millimeters

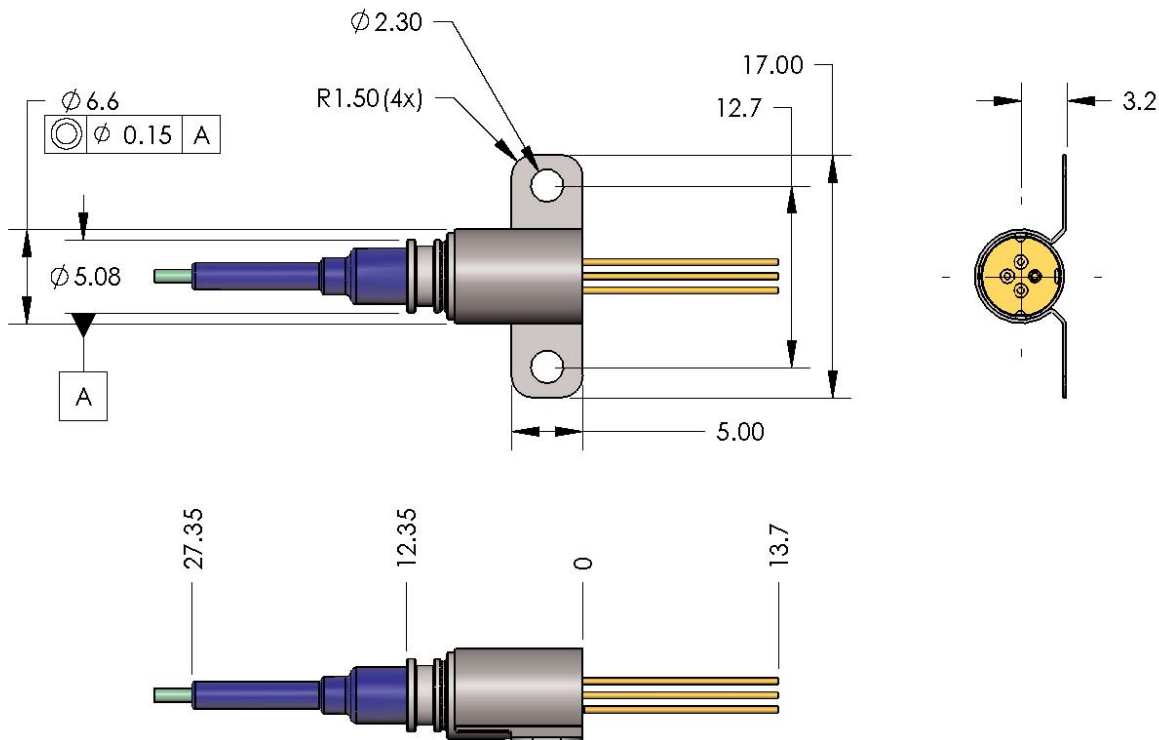

## ADVANCED OPTICAL COMPONENTS

Finisar's ADVANCED OPTICAL COMPONENTS division was formed through strategic acquisition of key optical component suppliers. The company has led the industry in high volume Vertical Cavity Surface Emitting Laser (VCSEL) and associated detector technology since 1996. VCSELs have become the primary laser source for optical data communication, and are rapidly expanding into a wide variety of sensor applications. VCSELs' superior reliability, low drive current, high coupled power, narrow and circularly symmetric beam and versatile packaging options (including arrays) are enabling solutions not possible with other optical technologies. ADVANCED OPTICAL COMPONENTS is also a key supplier of Fabry-Perot (FP) and Distributed Feedback (DFB) Lasers, and Optical Isolators (OI) for use in single mode fiber data and telecommunications networks

## LOCATION

- Allen, TX - Business unit headquarters, VCSEL wafer growth, wafer fabrication and TO package assembly.
- Fremont, CA – Wafer growth and fabrication of 1310 to 1550nm FP and DFB lasers.
- Shanghai, PRC – Optical passives assembly, including optical isolators and splitters.

## SALES AND SERVICE

Finisar's ADVANCED OPTICAL COMPONENTS division serves its customers through a worldwide network of sales offices and distributors. For application assistance, current specifications, pricing or name of the nearest Authorized Distributor, contact a nearby sales office or call the number listed below.

***Finisar***  
Advanced Optical Components Division

**Phone:** 1-866-MY-VCSEL USA (toll free)  
1-214-509-2700 USA (Direct dial)  
44 (0) 174 336 5533 Europe  
886-935-409898 China & Taiwan  
81-90-4437-1130 Japan  
82-11-220-6153 Asia Pacific & Korea

**Fax:** 1-214-509-3709 USA

Email: [salesAOCD@finisar.com](mailto:salesAOCD@finisar.com)  
WEB: [www.finisar.com/aoc.php](http://www.finisar.com/aoc.php)

## AOC CAPABILITIES

ADVANCED OPTICAL COMPONENTS' advanced capabilities include:

- 1, 2, 4, 8, and 10Gbps serial VCSEL solutions
- 1, 2, 4, 8, and 10Gbps serial SW DETECTOR solutions
- VCSEL and detector arrays
- 1, 2, 4, 8, and 10Gbps FP and DFB solutions at 1310 and 1550nm
- 1, 2, 4, 8, and 10Gbps serial LW DETECTOR solutions
- Optical Isolators from 1260 to 1600nm range
- Laser packaging in TO46, TO56, and Optical subassemblies with SC, LC, and MU interfaces for communication networks
- VCSELs operating at 670nm, 780nm, 980nm, and 1310nm in development
- Sensor packages include surface mount, various plastics, chip on board, chip scale packages, etc.
- Custom packaging options