

Round Trimming Potentiometer – 3309 9mm

TSR-3309



微 調 電 位 器

■ 單圈的/金屬陶瓷/工業用
 ■ (Single Turn/ Cermet/ Industrial)

■ 2種引線的安裝尺寸
 ■ (2 Terminal Styles)

電氣特性 Electrical Characteristics	
Standard Resistance Range	10Ω - 2MΩ
Resistance Tolerance	±30% std
Absolute Minimum Resistance	1% max (≤2K=30Ω)
Contact Resistance Variation	3% max
Resistance	Essentially infinite
Adjustment Angle	235° nom

環境特性 Environmental Characteristics	
Power Rating (50VDC max)	70°C, 0.5W
Temperature Range	-30°C ~ +100°C
Temperature Coefficient	±250ppm/°C
Load Life	1,000 hours 0.5W @70°C (3% ΔTR)

物理特性 Physical Characteristics	
Mechanical Angle	260°±10°
Toque (Operating)	4.0oz-in.max
Stop Strength	7.0oz-in.max
Terminals	Solderable pins
Marking	Manufacturer's Trademark, resistance code, date code
Standard packaging	200pcs. Per bag
Adjustment Tool	H-90
Aqueous cleaning not recommended	

訂購指南 How to Order

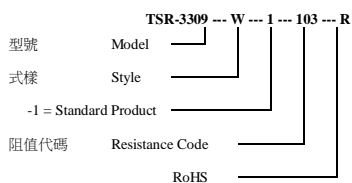

阻值代碼表 Standard Resistance table

Resistance(Ohms)	Resistance Code
10	100
20	200
50	500
100	101
200	201
500	501
1,000	102
2,000	202
5,000	502
10,000	103
20,000	203
25,000	253
50,000	503
100,000	104
200,000	204
250,000	254
500,000	504
1,000,000	105
2,000,000	205

可按用戶要求提供特殊規格
 Special resistances available.

Common Dimensions Top/Bottom Adjust

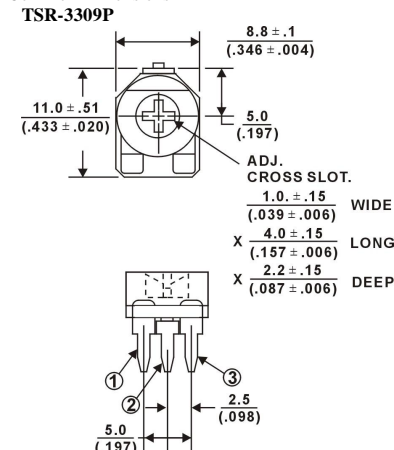

SUGGESTED PWB LAYOUT – TSR-3309P

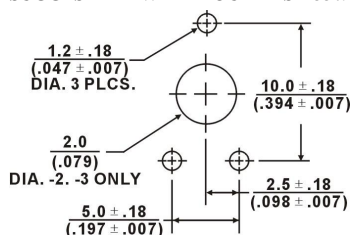

TSR-3309P-2 Both Sides Adjust/Cross Slot

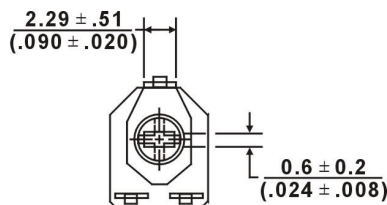
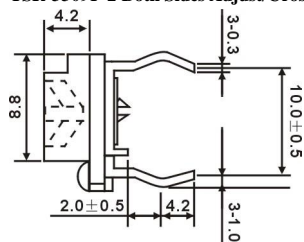

Slide Adjust Common Dimensions

TSR-3309W-1 Single Side (Front) Adjust

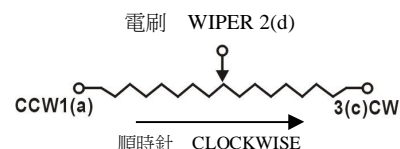
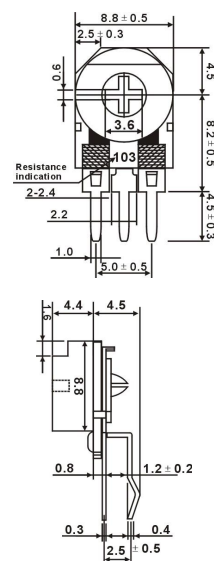

圖中公差：除注明外均為±0.25
 Tolerance is ±0.25 if no identification