

NTD14N03R, NVD14N03R

Power MOSFET

14 A, 25 V, N-Channel DPAK

Features

- Planar HD3e Process for Fast Switching Performance
- Low $R_{DS(on)}$ to Minimize Conduction Loss
- Low C_{iss} to Minimize Driver Loss
- Low Gate Charge
- Optimized for High Side Switching Requirements in High-Efficiency DC-DC Converters
- NVD and SVD Prefix for Automotive and Other Applications Requiring Unique Site and Control Change Requirements; AEC-Q101 Qualified and PPAP Capable
- These Devices are Pb-Free and are RoHS Compliant

MAXIMUM RATINGS ($T_J = 25^\circ\text{C}$ unless otherwise specified)

Parameter	Symbol	Value	Unit
Drain-to-Source Voltage	V_{DSS}	25	Vdc
Gate-to-Source Voltage – Continuous	V_{GS}	± 20	Vdc
Thermal Resistance – Junction-to-Case	$R_{\theta JC}$	6.0	$^\circ\text{C/W}$
Total Power Dissipation @ $T_A = 25^\circ\text{C}$	P_D	20.8	W
Drain Current – Continuous @ $T_A = 25^\circ\text{C}$, Chip	I_D	14	A
– Continuous @ $T_A = 25^\circ\text{C}$, Limited by Package	I_D	11.4	A
– Single Pulse ($t_p \leq 10 \mu\text{s}$)	I_D	28	A
Thermal Resistance, Junction-to-Ambient (Note 1)	$R_{\theta JA}$	80	$^\circ\text{C/W}$
Total Power Dissipation @ $T_A = 25^\circ\text{C}$	P_D	1.56	W
Drain Current – Continuous @ $T_A = 25^\circ\text{C}$	I_D	3.1	A
Thermal Resistance, Junction-to-Ambient (Note 2)	$R_{\theta JA}$	120	$^\circ\text{C/W}$
Total Power Dissipation @ $T_A = 25^\circ\text{C}$	P_D	1.04	W
Drain Current – Continuous @ $T_A = 25^\circ\text{C}$	I_D	2.5	A
Operating and Storage Temperature Range	T_J, T_{stg}	-55 to 150	$^\circ\text{C}$
Maximum Lead Temperature for Soldering Purposes, 1/8" from case for 10 seconds	T_L	260	$^\circ\text{C}$

Stresses exceeding those listed in the Maximum Ratings table may damage the device. If any of these limits are exceeded, device functionality should not be assumed, damage may occur and reliability may be affected.

1. When surface mounted to an FR4 board using 0.5 sq. in pad size.
2. When surface mounted to an FR4 board using minimum recommended pad size.



ON Semiconductor®

www.onsemi.com

14 AMPERES, 25 VOLTS
 $R_{DS(on)} = 70.4 \text{ m}\Omega$ (Typ)

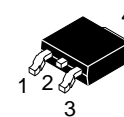
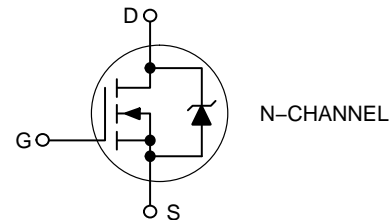

DPAK
CASE 369C
(Surface Mount)
STYLE 2

MARKING DIAGRAM & PIN ASSIGNMENTS

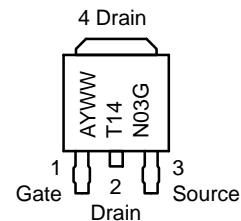

A = Assembly Location*
Y = Year
WW = Work Week
14N03 = Device Code
G = Pb-Free Package

* The Assembly Location code (A) is front side optional. In cases where the Assembly Location is stamped in the package, the front side assembly code may be blank.

ORDERING INFORMATION

See detailed ordering and shipping information on page 5 of this data sheet.

NTD14N03R, NVD14N03R

ELECTRICAL CHARACTERISTICS (T_J = 25°C unless otherwise specified)

Characteristics	Symbol	Min	Typ	Max	Unit
-----------------	--------	-----	-----	-----	------

OFF CHARACTERISTICS

Drain-to-Source Breakdown Voltage (Note 3) (V _{GS} = 0 Vdc, I _D = 250 μAdc) Temperature Coefficient (Positive)	V _{(br)DSS}	25 –	28 –	– –	Vdc mV/°C
Zero Gate Voltage Drain Current (V _{DS} = 20 Vdc, V _{GS} = 0 Vdc) (V _{DS} = 20 Vdc, V _{GS} = 0 Vdc, T _J = 150°C)	I _{DSS}	– –	– –	1.0 10	μAdc
Gate-Body Leakage Current (V _{GS} = ±20 Vdc, V _{DS} = 0 Vdc)	I _{GSS}	–	–	±100	nAdc

ON CHARACTERISTICS (Note 3)

Gate Threshold Voltage (Note 3) (V _{DS} = V _{GS} , I _D = 250 μAdc) Threshold Temperature Coefficient (Negative)	V _{GS(th)}	1.0 –	1.5 –	2.0 –	Vdc mV/°C
Static Drain-to-Source On-Resistance (Note 3) (V _{GS} = 4.5 Vdc, I _D = 5 Adc) (V _{GS} = 10 Vdc, I _D = 5 Adc)	R _{DS(on)}	– –	117 70.4	130 95	mΩ
Forward Transconductance (Note 3) (V _{DS} = 10 Vdc, I _D = 5 Adc)	g _{FS}	–	7.0	–	Mhos

DYNAMIC CHARACTERISTICS

Input Capacitance	(V _{DS} = 20 Vdc, V _{GS} = 0 V, f = 1 MHz)	C _{iss}	–	115	–	pF
Output Capacitance		C _{oss}	–	62	–	
Transfer Capacitance		C _{rss}	–	33	–	

SWITCHING CHARACTERISTICS (Note 4)

Turn-On Delay Time	(V _{GS} = 10 Vdc, V _{DD} = 10 Vdc, I _D = 5 Adc, R _G = 3 Ω)	t _{d(on)}	–	3.8	–	ns
Rise Time		t _r	–	27	–	
Turn-Off Delay Time		t _{d(off)}	–	9.6	–	
Fall Time		t _f	–	2.0	–	
Gate Charge	(V _{GS} = 5 Vdc, I _D = 5 Adc, V _{DS} = 10 Vdc) (Note 3)	Q _T	–	1.8	–	nC
	Q ₁	–	0.8	–		
	Q ₂	–	0.7	–		

SOURCE-DRAIN DIODE CHARACTERISTICS

Forward On-Voltage	(I _S = 5 Adc, V _{GS} = 0 Vdc) (Note 3) (I _S = 5 Adc, V _{GS} = 0 Vdc, T _J = 125°C)	V _{SD}	– –	0.93 0.82	1.2 –	Vdc
Reverse Recovery Time	(I _S = 5 Adc, V _{GS} = 0 Vdc, di _S /dt = 100 A/μs) (Note 3)	t _{rr}	–	6.6	–	ns
		t _a	–	4.75	–	
		t _b	–	1.88	–	
Reverse Recovery Stored Charge		Q _{RR}	–	0.002	–	μC

Product parametric performance is indicated in the Electrical Characteristics for the listed test conditions, unless otherwise noted. Product performance may not be indicated by the Electrical Characteristics if operated under different conditions.

3. Pulse Test: Pulse Width ≤ 300 μs, Duty Cycle ≤ 2%.

4. Switching characteristics are independent of operating junction temperatures.

NTD14N03R, NVD14N03R

TYPICAL CHARACTERISTICS

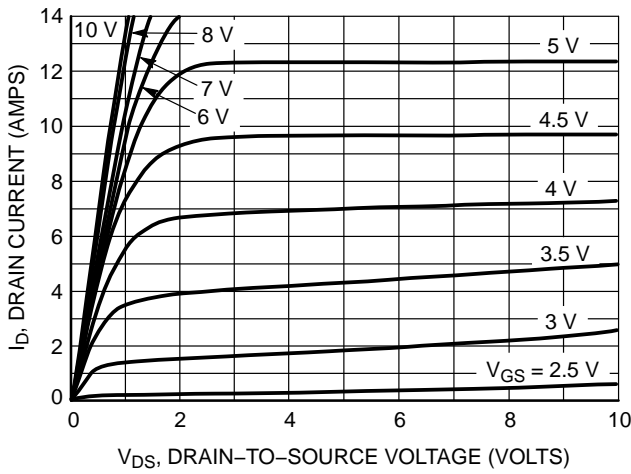

Figure 1. On-Region Characteristics

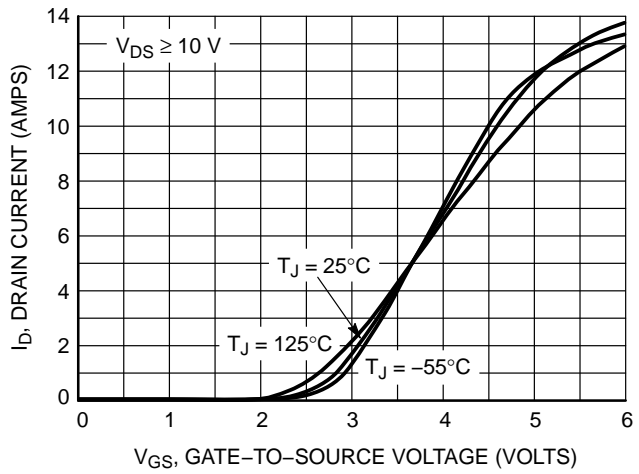

Figure 2. Transfer Characteristics

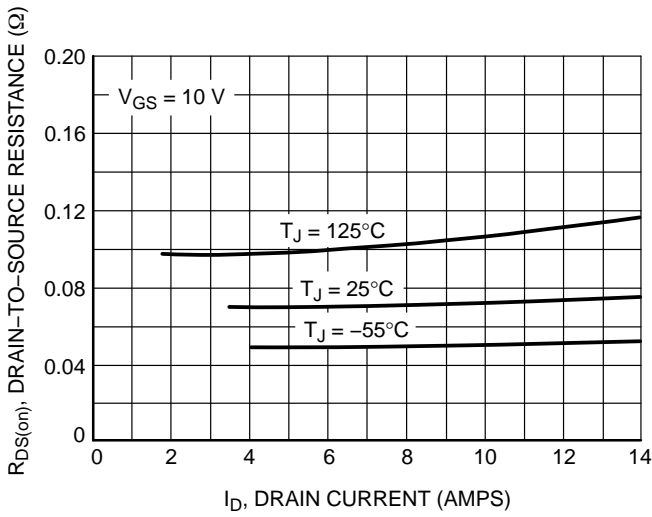

Figure 3. On-Resistance versus Drain Current and Temperature

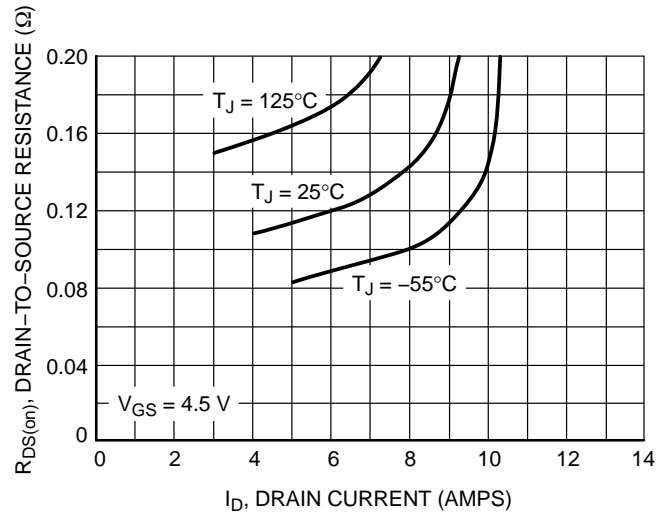

Figure 4. On-Resistance versus Drain Current and Temperature

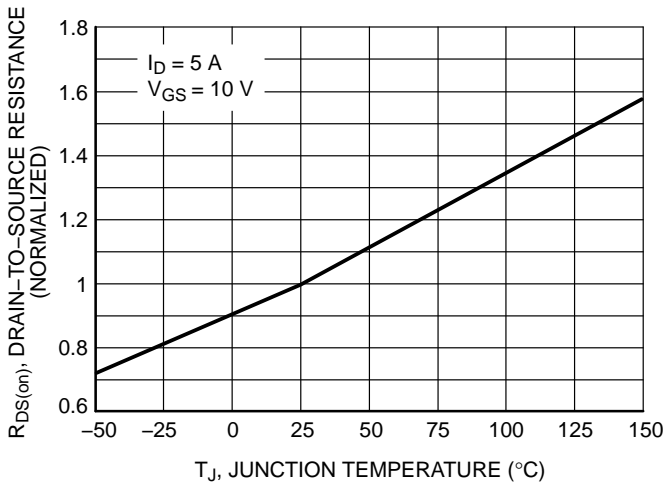

Figure 5. On-Resistance Variation with Temperature

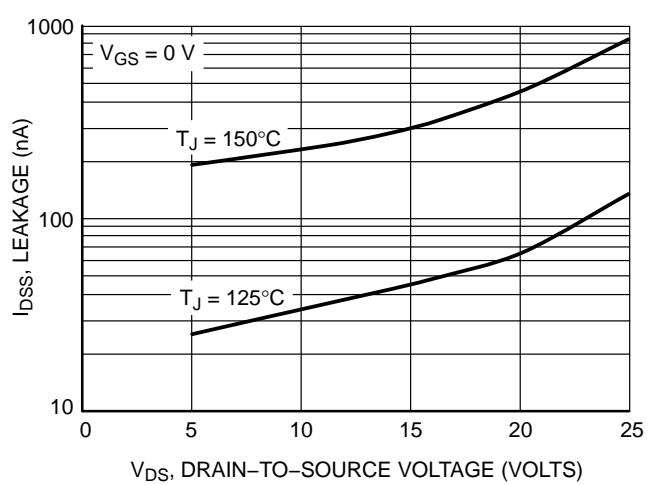

Figure 6. Drain-to-Source Leakage Current versus Voltage

NTD14N03R, NVD14N03R

TYPICAL CHARACTERISTICS

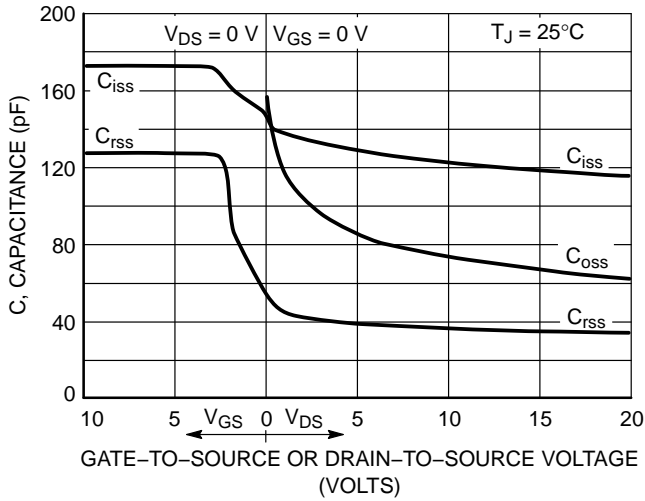

Figure 7. Capacitance Variation

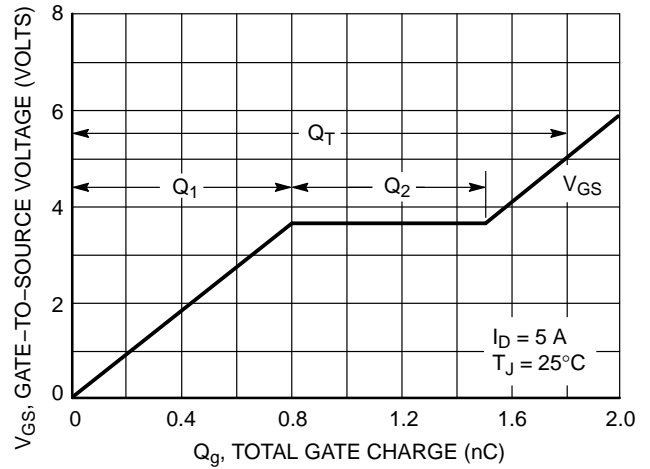

Figure 8. Gate-to-Source and Drain-to-Source Voltage versus Total Charge

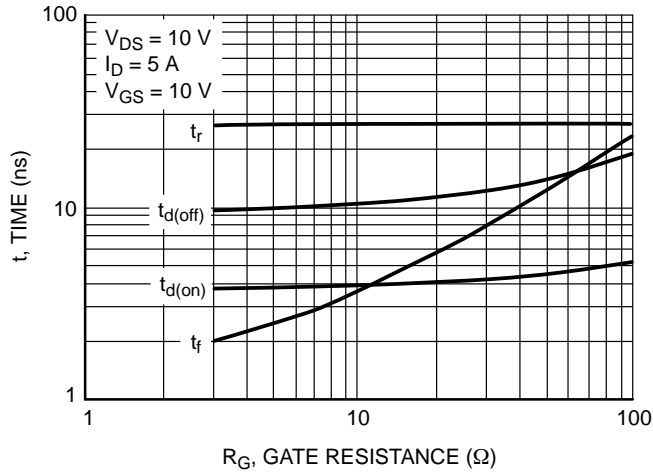

Figure 9. Resistive Switching Time Variation versus Gate Resistance

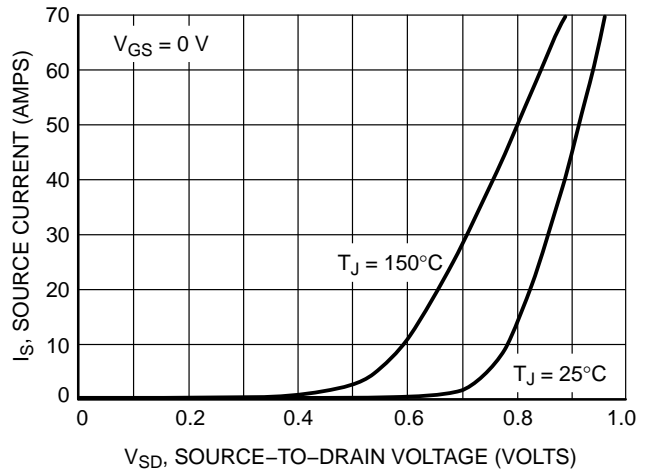

Figure 10. Diode Forward Voltage versus Current

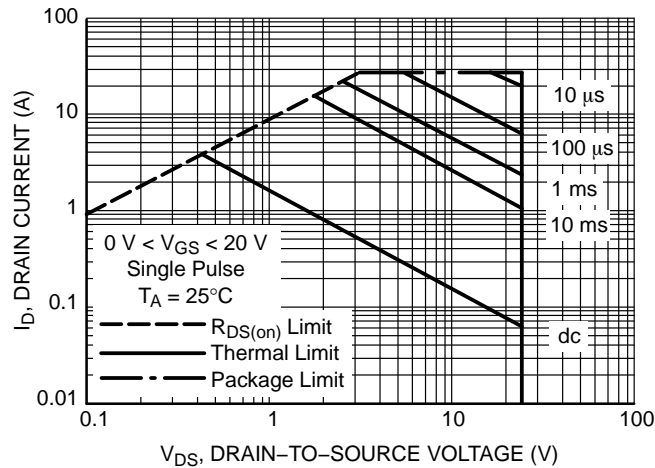

Figure 11. Maximum Rated Forward Biased Safe Operating Area

NTD14N03R, NVD14N03R

TYPICAL CHARACTERISTICS

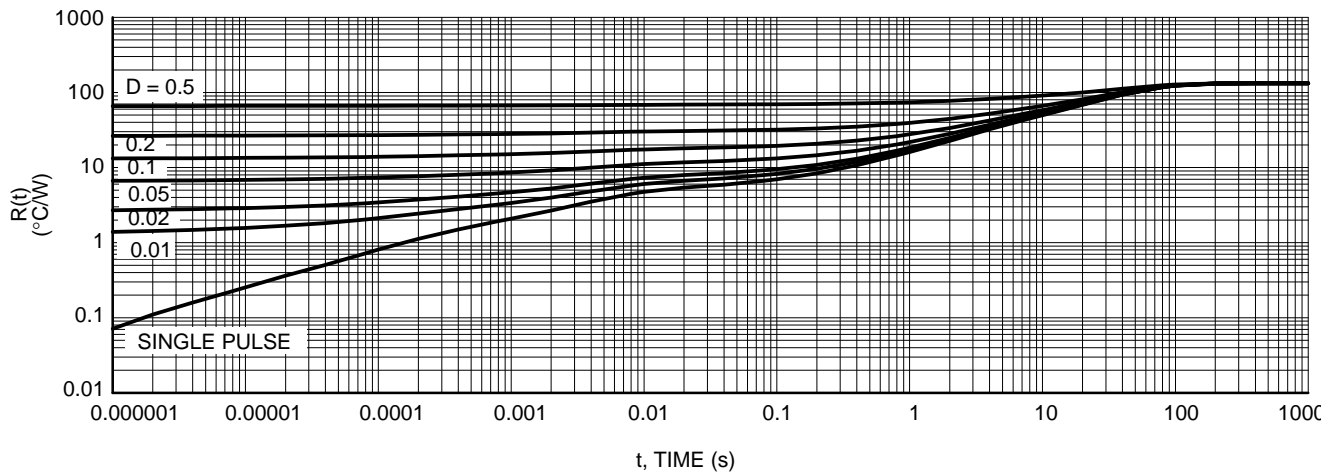

Figure 12. Thermal Response

ORDERING INFORMATION

Device	Package	Shipping [†]
NTD14N03RT4G	DPAK (Pb-Free)	2500 / Tape & Reel
NVD14N03RT4G*	DPAK (Pb-Free)	2500 / Tape & Reel
SVD14N03RT4G*	DPAK (Pb-Free)	2500 / Tape & Reel

[†]For information on tape and reel specifications, including part orientation and tape sizes, please refer to our Tape and Reel Packaging Specifications Brochure, BRD8011/D.

*NVD and SVD Prefix for Automotive and Other Applications Requiring Unique Site and Control Change Requirements; AEC-Q101 Qualified and PPAP Capable.

NTD14N03R, NVD14N03R

PACKAGE DIMENSIONS

DPAK (SINGLE GAUGE) CASE 369C ISSUE F

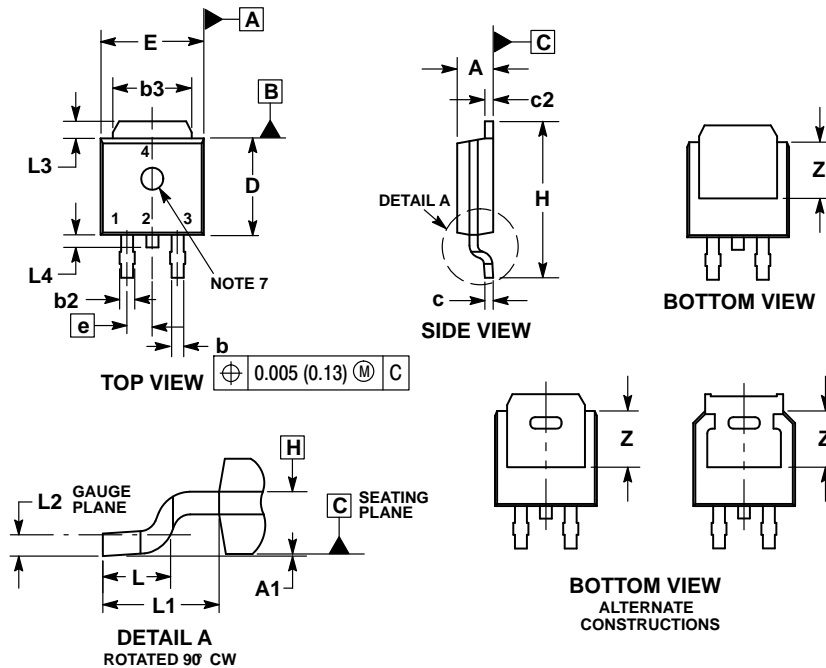

NOTES:

1. DIMENSIONING AND TOLERANCING PER ASME Y14.5M, 1994.
2. CONTROLLING DIMENSION: INCHES.
3. THERMAL PAD CONTOUR OPTIONAL WITHIN DIMENSIONS b3, L3 and Z.
4. DIMENSIONS D AND E DO NOT INCLUDE MOLD FLASH, PROTRUSIONS, OR BURRS. MOLD FLASH, PROTRUSIONS, OR GATE BURRS SHALL NOT EXCEED 0.006 INCHES PER SIDE.
5. DIMENSIONS D AND E ARE DETERMINED AT THE OUTERMOST EXTREMES OF THE PLASTIC BODY.
6. DATUMS A AND B ARE DETERMINED AT DATUM PLANE H.
7. OPTIONAL MOLD FEATURE.

DIM	INCHES		MILLIMETERS	
	MIN	MAX	MIN	MAX
A	0.086	0.094	2.18	2.38
A1	0.000	0.005	0.00	0.13
b	0.025	0.035	0.63	0.89
b2	0.028	0.045	0.72	1.14
b3	0.180	0.215	4.57	5.46
c	0.018	0.024	0.46	0.61
c2	0.018	0.024	0.46	0.61
D	0.235	0.245	5.97	6.22
E	0.250	0.265	6.35	6.73
e	0.090	BSC	2.29	BSC
H	0.370	0.410	9.40	10.41
L	0.055	0.070	1.40	1.78
L1	0.114	REF	2.90	REF
L2	0.020	BSC	0.51	BSC
L3	0.035	0.050	0.89	1.27
L4	---	0.040	---	1.01
Z	0.155	---	3.93	---

STYLE 2:

1. GATE
2. DRAIN
3. SOURCE
4. DRAIN

SOLDERING FOOTPRINT*

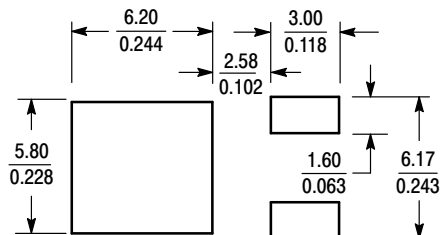

SCALE 3:1 (mm / inches)

*For additional information on our Pb-Free strategy and soldering details, please download the ON Semiconductor Soldering and Mounting Techniques Reference Manual, SOLDERRM/D.

ON Semiconductor and are trademarks of Semiconductor Components Industries, LLC dba ON Semiconductor or its subsidiaries in the United States and/or other countries. ON Semiconductor owns the rights to a number of patents, trademarks, copyrights, trade secrets, and other intellectual property. A listing of ON Semiconductor's product/patent coverage may be accessed at www.onsemi.com/site/pdf/Patent-Marking.pdf. ON Semiconductor reserves the right to make changes without further notice to any products herein. ON Semiconductor makes no warranty, representation or guarantee regarding the suitability of its products for any particular purpose, nor does ON Semiconductor assume any liability arising out of the application or use of any product or circuit, and specifically disclaims any and all liability, including without limitation special, consequential or incidental damages. Buyer is responsible for its products and applications using ON Semiconductor products, including compliance with all laws, regulations and safety requirements or standards, regardless of any support or applications information provided by ON Semiconductor. "Typical" parameters which may be provided in ON Semiconductor data sheets and/or specifications can and do vary in different applications and actual performance may vary over time. All operating parameters, including "Typicals" must be validated for each customer application by customer's technical experts. ON Semiconductor does not convey any license under its patent rights nor the rights of others. ON Semiconductor products are not designed, intended, or authorized for use as a critical component in life support systems or any FDA Class 3 medical devices or medical devices with a same or similar classification in a foreign jurisdiction or any devices intended for implantation in the human body. Should Buyer purchase or use ON Semiconductor products for any such unintended or unauthorized application, Buyer shall indemnify and hold ON Semiconductor and its officers, employees, subsidiaries, affiliates, and distributors harmless against all claims, costs, damages, and expenses, and reasonable attorney fees arising out of, directly or indirectly, any claim of personal injury or death associated with such unintended or unauthorized use, even if such claim alleges that ON Semiconductor was negligent regarding the design or manufacture of the part. ON Semiconductor is an Equal Opportunity/Affirmative Action Employer. This literature is subject to all applicable copyright laws and is not for resale in any manner.

PUBLICATION ORDERING INFORMATION

LITERATURE FULFILLMENT:

Literature Distribution Center for ON Semiconductor
19521 E. 32nd Pkwy, Aurora, Colorado 80011 USA
Phone: 303-675-2175 or 800-344-3860 Toll Free USA/Canada
Fax: 303-675-2176 or 800-344-3867 Toll Free USA/Canada
Email: orderlit@onsemi.com

N. American Technical Support: 800-282-9855 Toll Free
USA/Canada
Europe, Middle East and Africa Technical Support:
Phone: 421 33 790 2910
Japan Customer Focus Center
Phone: 81-3-5817-1050

ON Semiconductor Website: www.onsemi.com

Order Literature: <http://www.onsemi.com/orderlit>

For additional information, please contact your local Sales Representative