

### 描述 / Descriptions

TO-220F 塑封封装 NPN 半导体三极管。Silicon NPN transistor in a TO-220F Plastic Package.

### 特征 / Features

击穿电压高,反向漏电流小,饱和压降低。

High  $V_{CEO}$ , small  $I_{CBO}$  and  $V_{CE(sat)}$ .

### 用途 / Applications

用于彩色电视机扫描调速电路及一般高频放大电路。

Color TV deflection speed modulating and high-frequency general purpose amplifiers.

### 内部等效电路 / Equivalent Circuit

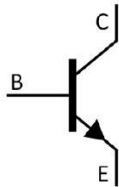

### 引脚排列 / Pinning

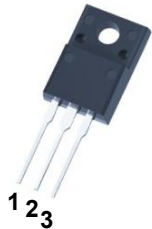

PIN1 : Base      PIN 2 : Collector      PIN 3 : Emitter

### 放大及印章代码 / $h_{FE}$ Classifications & Marking

|                                    |        |         |
|------------------------------------|--------|---------|
| $h_{FE}$ Classifications<br>Symbol | R      | O       |
| $h_{FE}$ Range                     | 60~140 | 100~240 |

**极限参数 / Absolute Maximum Ratings(Ta=25°C)**

| 参数<br>Parameter                | 符号<br>Symbol                | 数值<br>Rating | 单位<br>Unit |
|--------------------------------|-----------------------------|--------------|------------|
| Collector to Base Voltage      | $V_{CBO}$                   | 180          | V          |
| Collector to Emitter Voltage   | $V_{CEO}$                   | 160          | V          |
| Emitter to Base Voltage        | $V_{EBO}$                   | 6.0          | V          |
| Collector Current - Continuous | $I_C$                       | 1.5          | A          |
| Collector Power Dissipation    | $P_C$                       | 1.5          | W          |
| Collector Power Dissipation    | $P_C(T_c=25^\circ\text{C})$ | 25           | W          |
| Junction Temperature           | $T_j$                       | 150          | °C         |
| Storage Temperature Range      | $T_{stg}$                   | -55~150      | °C         |

**电性能参数 / Electrical Characteristics(Ta=25°C)**

| 参数<br>Parameter                         | 符号<br>Symbol  | 测试条件<br>Test Conditions              | 最小值<br>Min | 典型值<br>Typ | 最大值<br>Max | 单位<br>Unit    |
|---|---------------|--------------------------------------|------------|------------|------------|---------------|
| Collector Cut-Off Current               | $I_{CBO}$     | $V_{CB}=180V$ $I_E=0$                |            |            | 10         | $\mu\text{A}$ |
| Emitter Cut-Off Current                 | $I_{EBO}$     | $V_{EB}=6.0V$ $I_C=0$                |            |            | 10         | $\mu\text{A}$ |
| DC Current Gain                         | $h_{FE}$      | $V_{CE}=5.0V$ $I_C=200\text{mA}$     | 60         |            | 240        |               |
| Collector to Emitter Saturation Voltage | $V_{CE(sat)}$ | $I_C=500\text{mA}$ $I_B=50\text{mA}$ |            |            | 1.0        | V             |
| Transition Frequency                    | $f_T$         | $V_{CE}=10V$ $I_C=50\text{mA}$       | 50         |            |            | MHz           |

**电参数曲线图 / Electrical Characteristic Curve**

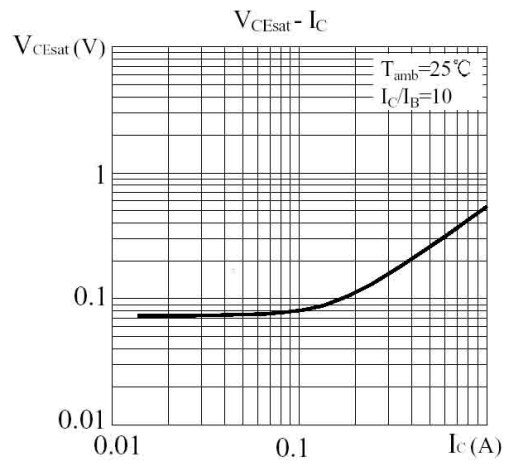
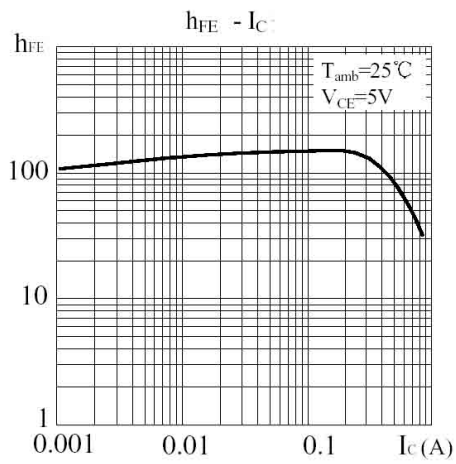
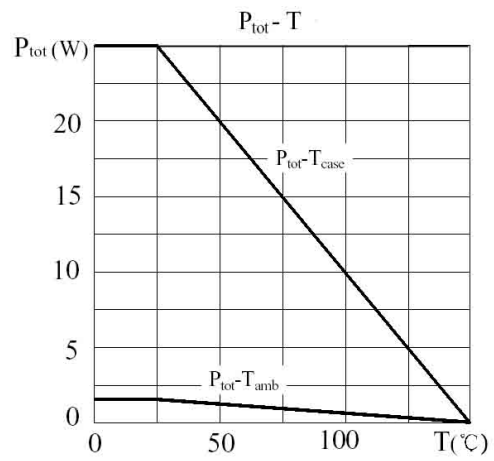
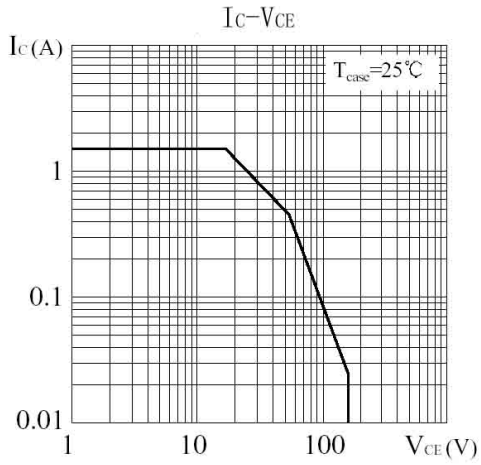

外形尺寸图 / Package Dimensions

T0-220F

单位: mm

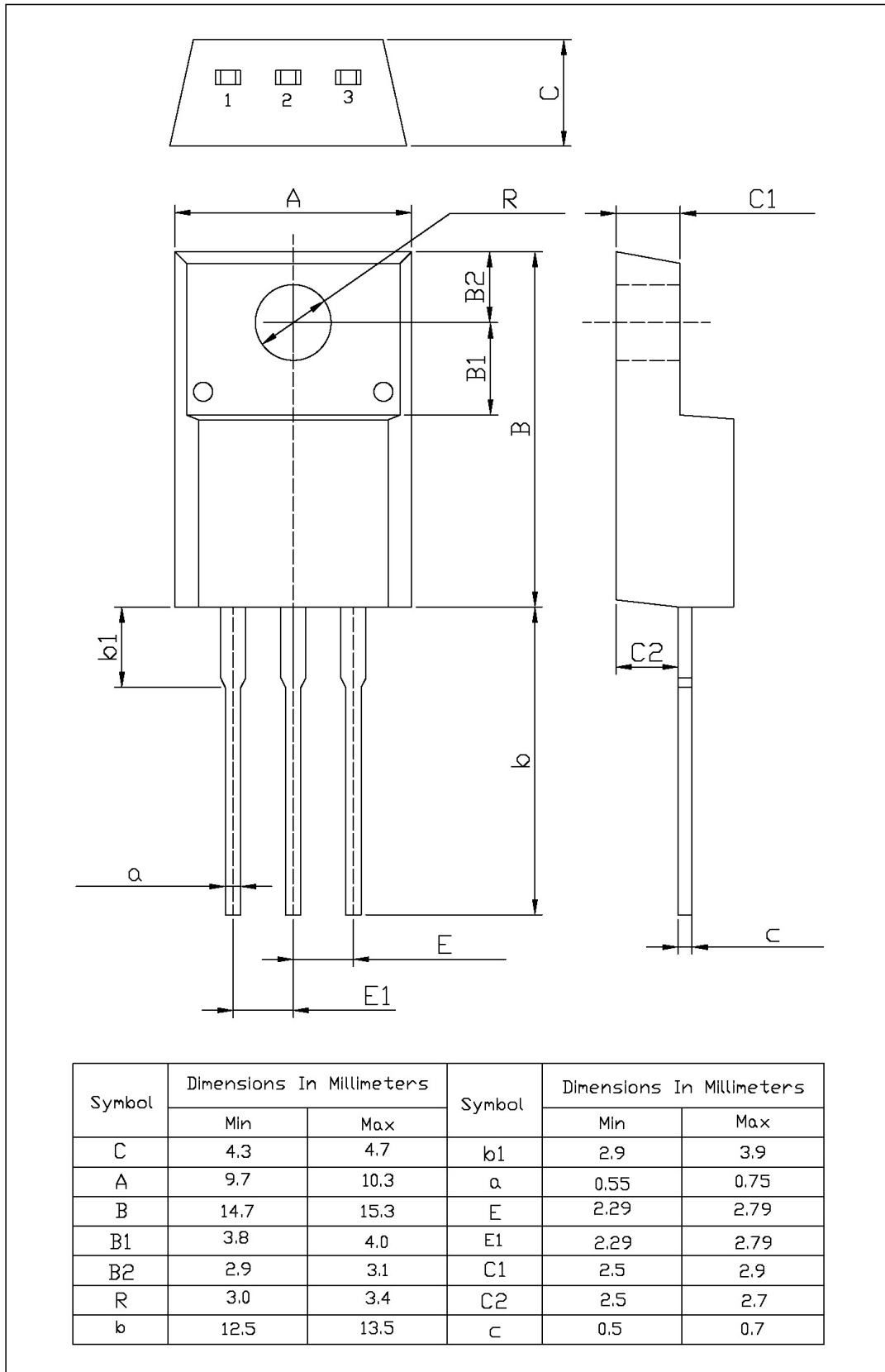

印章说明 / Marking Instructions

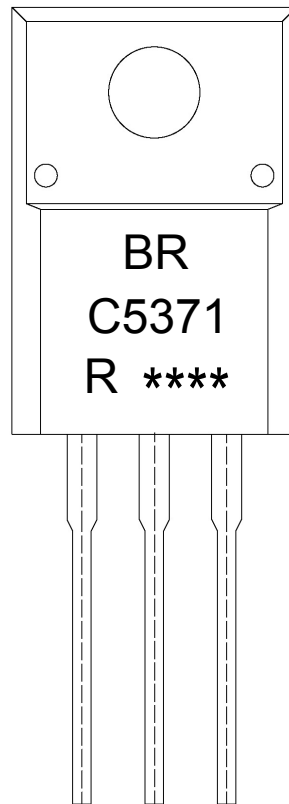

说明：

BR： 为公司代码

C5371： 为型号代码

R： 为  $h_{FE}$  分档代码

\*\*\*\*： 为生产批号代码，随生产批号变化。

Note:

BR: Company Code.

C5371: Product Type.

R:  $h_{FE}$  Classifications Symbol.

\*\*\*\*: Lot No. Code, code change with Lot No.

**波峰焊温度曲线图(无铅) / Temperature Profile for Dip Soldering(Pb-Free)**



说明：

- 1、预热温度 25 ~ 150°C，时间 60 ~ 90sec;
- 2、峰值温度 255±5°C，时间持续为 5±0.5sec;
- 3、焊接制程冷却速度为 2 ~ 10°C/sec.

Note:

- 1.Preheating:25~150°C, Time:60~90sec.
- 2.Peak Temp.:255±5°C, Duration:5±0.5sec.
3. Cooling Speed: 2~10°C/sec.

**耐焊接热试验条件 / Resistance to Soldering Heat Test Conditions**

温度：270±5°C      时间：10±1 sec.      Temp.:270±5°C      Time:10±1 sec

**包装规格 / Packaging SPEC.**

散件包装 / BULK

| Package Type<br>封装形式 | Units 包装数量       |                       |                        |                              |                        | Dimension 包装尺寸 (unit: mm <sup>3</sup> ) |             |             |
|----------------------|------------------|-----------------------|------------------------|------------------------------|------------------------|---|-------------|-------------|
|                      | Units/Bag<br>只/袋 | Bags/Inner Box<br>袋/盒 | Units/Inner Box<br>只/盒 | Inner Boxes/Outer Box<br>盒/箱 | Units/Outer Box<br>只/箱 | Bag 袋                                   | Inner Box 盒 | Outer Box 箱 |
| TO-220/F             | 200              | 10                    | 2,000                  | 5                            | 10,000                 | 135×190                                 | 237×172×102 | 560×245×195 |

套管包装 / TUBE

| Package Type<br>封装形式 | Units 包装数量         |                         |                        |                              |                        | Dimension 包装尺寸 (unit: mm <sup>3</sup> ) |             |             |
|----------------------|--------------------|-------------------------|------------------------|------------------------------|------------------------|---|-------------|-------------|
|                      | Units/Tube<br>只/套管 | Tubes/Inner Box<br>套管/盒 | Units/Inner Box<br>只/盒 | Inner Boxes/Outer Box<br>盒/箱 | Units/Outer Box<br>只/箱 | Tube 套管                                 | Inner Box 盒 | Outer Box 箱 |
| TO-220/F             | 50                 | 20                      | 1,000                  | 5                            | 5,000                  | 532×31.4×5.5                            | 555×164×50  | 575×290×180 |

**使用说明 / Notices**