

MAX17542G 5V Output Evaluation Kit

Evaluates: MAX17542G in 5V Output-Voltage Application

General Description

The MAX17542G 5V Output EV kit provides a proven design to evaluate the MAX17542G 5V high-efficiency, high-voltage, synchronous step-down DC-DC converter in a TDFN package. The EV kit generates 5V at load currents up to 1A from a 6V to 42V input supply. The EV kit features a 600kHz fixed switching frequency for optimum efficiency and component size. The EV kit features a forced-PWM control scheme that provides constant switching-frequency operation at all load and line conditions.

Features

- Operates from a 6V to 42V Input Supply
- 5V Output Voltage
- 1A Output Current
- 600kHz Switching Frequency
- Enable/UVLO Input
- Resistor-Programmable UVLO Threshold
- Open-Drain $\overline{\text{RESET}}$ Output
- Overcurrent and Overtemperature Protection
- Proven PCB Layout
- Fully Assembled and Tested

Ordering Information appears at end of data sheet.

Quick Start

Recommended Equipment

- MAX17542G 5V Output EV kit
- 6V to 42V, 2A DC input power supply
- Load capable of sinking 1A
- Digital voltmeter (DVM)
- Function generator

Procedure

The EV kit is fully assembled and tested. Follow the steps below to verify the board operation. **Caution: Do not turn on power supply until all connections are completed.**

- 1) Set the power supply at a voltage between 6V and 42V. Disable the power supply.
- 2) Connect the positive terminal of the power supply to the VIN PCB pad and the negative terminal to the nearest PGND PCB pad. Connect the positive terminal of the 1A load to the VOUT PCB pad and the negative terminal to the nearest PGND PCB pad.
- 3) Connect the DVM across the VOUT PCB pad and the nearest PGND PCB pad.
- 4) Turn on the DC power supply.
- 5) Enable the load.
- 6) Verify that the DVM displays 5V.

To turn-on/off the part from EN/UVLO, follow the steps below:

- 1) Connect the power supply to the EV kit and turn on the power supply. Set the power supply at a voltage between 6V and 42V.
- 2) Connect the function generator output to the EN/UVLO test loop.
- 3) EN/UVLO rising threshold is 1.24V and falling threshold is 1.11V. Make sure that the voltage-high and voltage-low levels of the function generator output are greater than 1.24V and less than 1.11V, respectively.
- 4) While powering down the EV kit, first disconnect the function generator output from the EN/UVLO test loop and then turn off the DC power supply.

MAX17542G 5V Output Evaluation Kit

Evaluates: MAX17542G in 5V Output-Voltage Application

Detailed Description of Hardware

The MAX17542G 5V Output EV kit provides a proven design to evaluate the MAX17542G 5V high-efficiency, high-voltage, synchronous step-down DC-DC converter in a TDFN package. The EV kit generates 5V at load currents up to 1A from a 6V to 42V input supply. The EV kit features a 600kHz fixed switching frequency for optimum efficiency and component size. The EV kit features a forced-PWM control scheme that provides constant switching-frequency operation at all load and line conditions.

The EV kit includes an EN/UVLO PCB pad to enable control of the converter output. An additional RESET PCB pad is available for monitoring the open-drain logic output. The VCC PCB pad helps measure the internal LDO voltage.

Soft-Start Input (SS)

The device utilizes an adjustable soft-start function to limit inrush current during startup. The soft-start time is adjusted by the value of C3, the external capacitor from SS to GND. To adjust the soft-start time, determine C3 using the following formula:

$$C3 = 5.55 \times t_{SS}$$

where t_{SS} is the required soft-start time in milliseconds and C3 is in nanofarads.

Regulator Enable/Undervoltage-Lockout Level (EN/UVLO)

The device features an EN/UVLO input. For normal operation, no shunts should be installed across pins 1-2 or 2-3 on jumper JU1. To disable the output, install a shunt across pins 2-3 on JU1 and the EN/UVLO pin is pulled to GND. See [Table 1](#) for JU1 settings.

Setting the Undervoltage-Lockout Level

The device offers an adjustable input undervoltage-lockout level. Set the voltage at which the device turns on with a resistive voltage-divider connected from VIN to GND (see [Figure 1](#)). Connect the center node of the divider to EN/UVLO.

Choose R1 to be 3.3MΩ and then calculate R2 as follows:

$$R2 = \frac{R1 \times 1.218}{(V_{INU} - 1.218)}$$

where V_{INU} is the voltage at which the device is required to turn on. Ensure that V_{INU} is higher than $0.8 \times V_{OUT}$.

Adjusting the Output Voltage

The device offers an adjustable output voltage. Set the output voltage with a resistive voltage-divider connected from the positive terminal of the output capacitor (V_{OUT}) to GND (see schematic attached to this PDF). Connect the center node of the voltage-divider to FB.

To choose the values of R4 and R5, select the parallel combination of R4 and R5, with R_P less than 15kΩ. Once R_P is selected, calculate R4 as follows:

$$R4 = \frac{R_P \times V_{OUT}}{0.9}$$

Calculate R5 as follows:

$$R5 = \frac{R4 \times 0.9}{(V_{OUT} - 0.9)}$$

Table 1. Regulator Enable (EN/UVLO) Jumper JU1 Settings

SHUNT POSITION	EV/UVLO PIN	MAX17542G 5V OUTPUT
Not installed*	Connected to the center node of resistor-divider R1 and R2	Enabled, UVLO level set through the R1 and R2 resistor-divider
2-3	Connected to GND	Disabled

*Default position.

MAX17542G 5V Output Evaluation Kit

Evaluates: MAX17542G in 5V Output-Voltage Application

EV Kit Performance Report

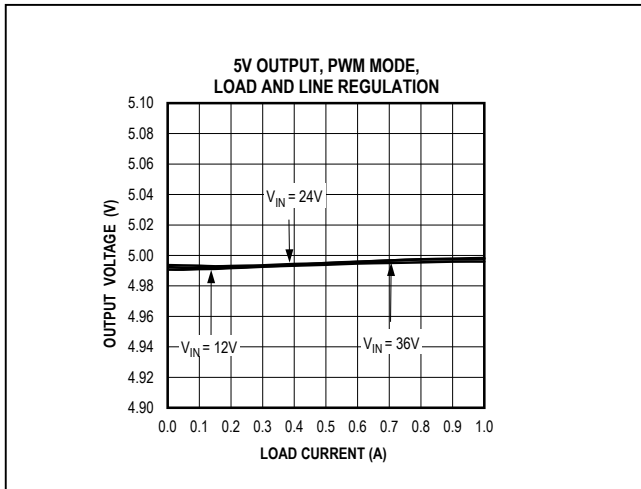

Figure 1. MAX17542G 5V Output Load and Line Regulation

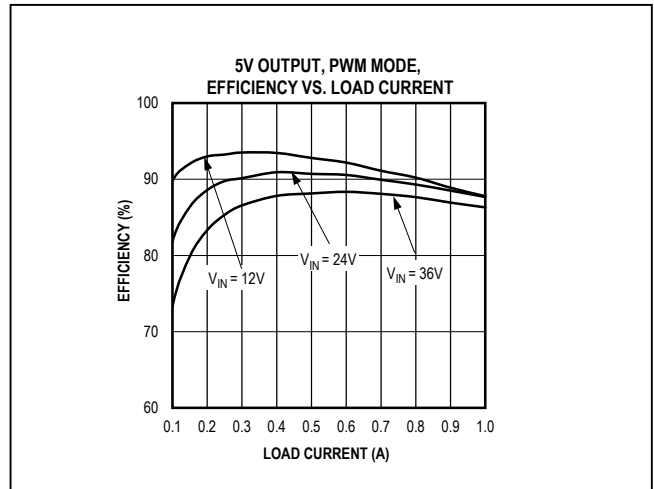

Figure 2. MAX17542G 5V Output Efficiency

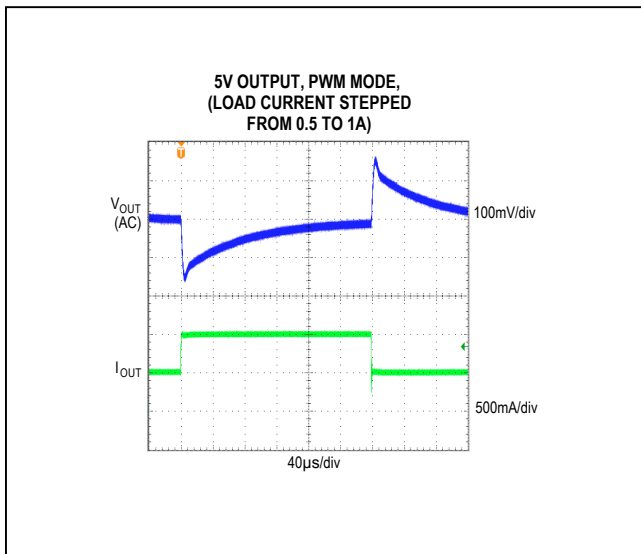

Figure 3. MAX17542G 5V Output 500mA to 1A Load Transient

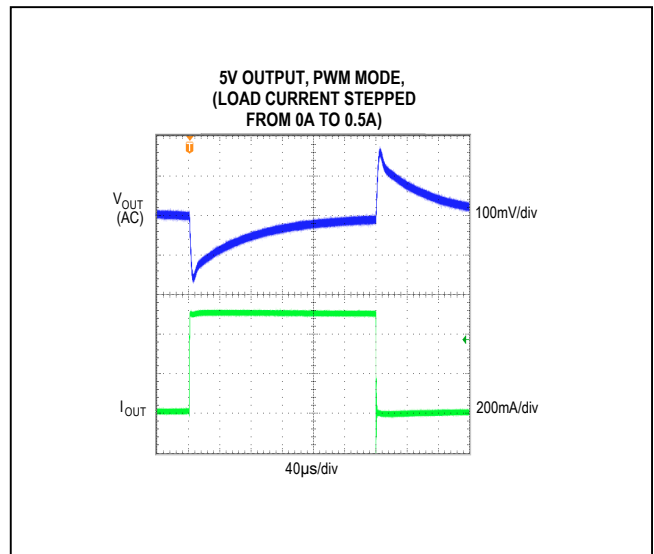

Figure 4. MAX17542G 5V Output No-Load to 500mA Load Transient

EV Kit Performance Report (continued)

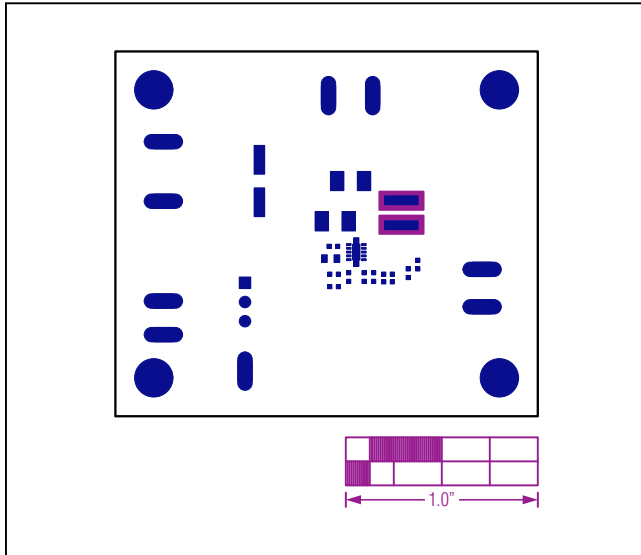

Figure 9. MAX17542G 5V Output EV Kit Component Placement Guide—Top Solder Mask

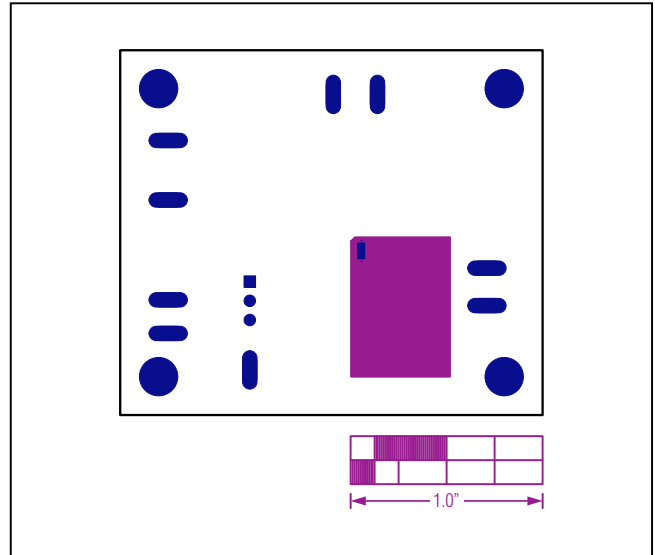

Figure 10. MAX17542G 5V Output EV Kit Component Placement Guide—Bottom Solder Mask

Component Suppliers

SUPPLIER	WEBSITE
Coilcraft, Inc.	www.coilcraft.com
Murata Americas	www.murata.com
Panasonic Corp.	www.panasonic.com
TDK Corp.	ww.tdk.com

Note: Indicate that you are using the MAX17542G when contacting these component suppliers.

Component Information and Schematic

See the following links for component information and schematic:

- [MAX17542G 5V EV BOM](#)
- [MAX17542G 5V EV Schematic](#)

Ordering Information

PART	TYPE
MAX17542GTBEVKIT#	EV Kit

#Denotes RoHS compliant.

MAX17542G 5V Output
Evaluation Kit

Evaluates: MAX17542G in 5V
Output-Voltage Application

Revision History

REVISION NUMBER	REVISION DATE	DESCRIPTION	PAGES CHANGED
0	6/15	Initial release	—

For pricing, delivery, and ordering information, please contact Maxim Direct at 1-888-629-4642, or visit Maxim Integrated's website at www.maximintegrated.com.

Maxim Integrated cannot assume responsibility for use of any circuitry other than circuitry entirely embodied in a Maxim Integrated product. No circuit patent licenses are implied. Maxim Integrated reserves the right to change the circuitry and specifications without notice at any time.

5

4

3

2

1

D

C

B

A



TITLE: MAX17542GTB EVKIT	REV: A
-----------------------------	-----------

DRAWN:	DATED:
--------	--------

PCB PART NUMBER:	SHEET: 1 OF 1
------------------	---------------

APPROVAL	DATED:
----------	--------

REVISION:	DATED:
-----------	--------

REVISION:	DATED:
-----------	--------

REVISION:	DATED:
-----------	--------

REVISION:	DATED:
-----------	--------

REVISION:	DATED:
-----------	--------

REVISION:	DATED:
-----------	--------

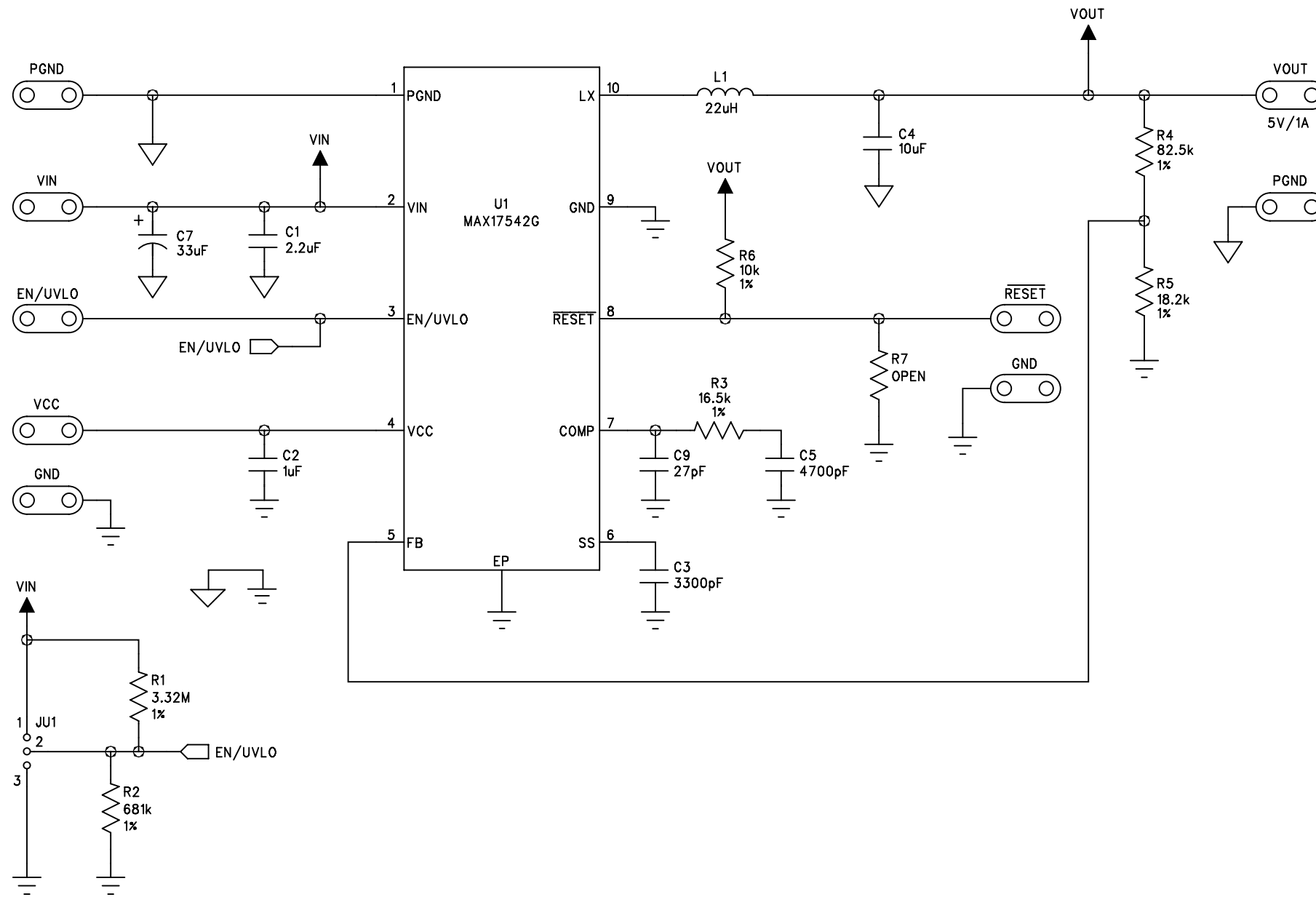

BILL OF MATERIALS (BOM) 6/15 Revision

Reference	Description	Quantity	Designator	Part Number
1	2.2µF ±10%, 50V X7R ceramic capacitor (1210)	1	C1	TDK C3225X7R1H225K
2	1µF ±10%, 6.3V X7R ceramic capacitor (0603)	1	C2	Murata GRM188R70J105K
3	3300pF ±10%, 50V X7R ceramic capacitor (0402)	1	C3	Murata GRM155R71H332K
4	10µF ±10%, 10V X7R ceramic capacitor (1210)	1	C4	Murata GRM32DR71A106K
5	4700pF ±10%, 25V X7R ceramic capacitor (0402)	1	C5	Murata GRM155R71E472K
6	33µF 50V aluminum electrolytic (D=6.3mm)	1	C7	Panasonic EEE-FK1H330XP
7	27pF ±5%, 50V C0G ceramic capacitor (0402)	1	C9	Murata GRM1555C1H270J
8	3-pin header (36-pin header 0.1" centers)	1	JU1	Sullins: PTC36SAAN
9	22µH Inductor (5.3mm x 5.5mm x 5.1mm)	1	L1	Coilcraft XAL5050-223
10	3.32M ohm ±1%, resistor (0402)	1	R1	
11	681k ohm ±1%, resistor (0402)	1	R2	
12	16.5k ohm ±1%, resistor (0402)	1	R3	
13	82.5k ohm ±1%, resistor (0402)	1	R4	
14	18.2k ohm ±1%, resistor (0402)	1	R5	
15	10k ohm ±1%, resistor (0402)	1	R6	
16	Not installed, OPEN (0402)	0	R7	
17	Buck Converter (10TDFN 3mmx2mm) MAX17542GATB+	1	U1	MAX17542GATB+
18	Shunt	1	See Jumper Table	SULLINS STC02SYAN

Jumper Table

JUMPER	SHUNT POSITION
JU1	1-2