

# Keysight U7238C and U7238D

## MIPI D-PHY Conformance Test Software

### For Infiniium Oscilloscopes

Data Sheet

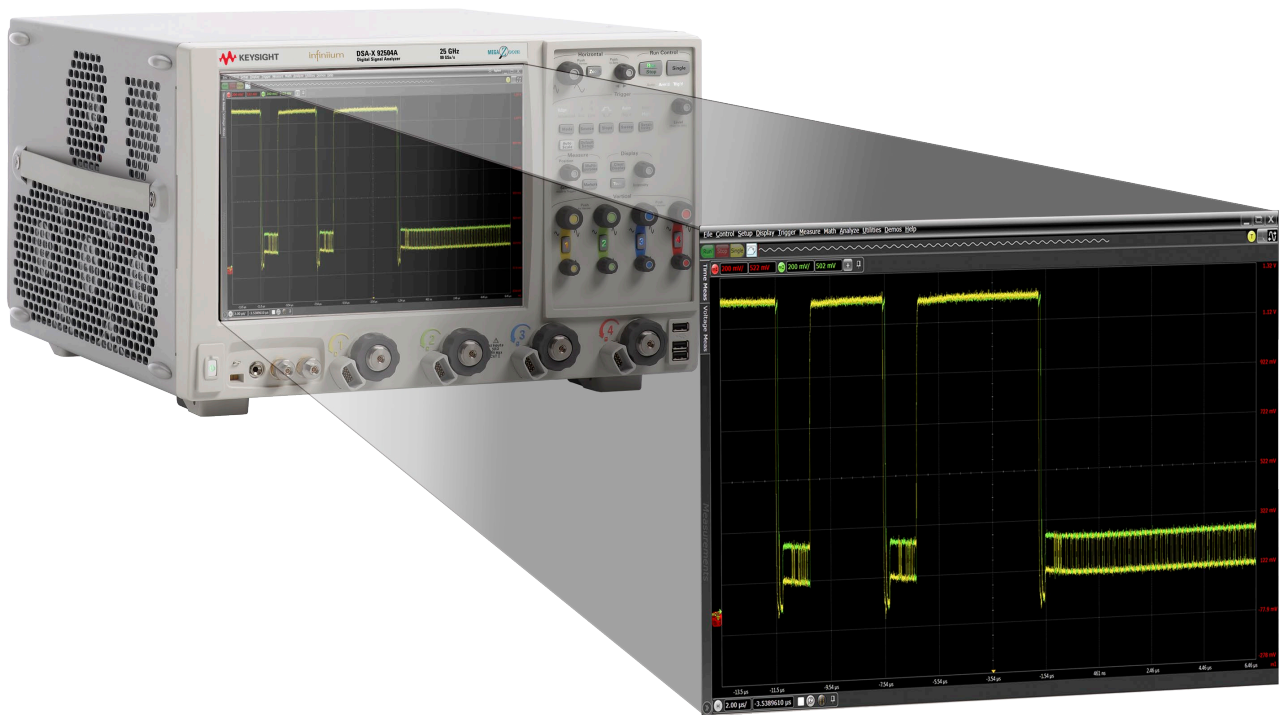

Unlocking Measurement Insights

## Validate and Debug Your Embedded D-PHY Data Links Quickly and Easily

Keysight Technologies, Inc. MIPI® D-PHY<sup>SM</sup> conformance test software for Infiniium oscilloscopes gives you a fast, easy way to validate and debug your embedded D-PHY data links. The D-PHY electrical test software allows you to automatically execute D-PHY electrical checklist tests for CSI-2 and DSI architectures, and displays the results in a flexible report format. In addition to the measurement data, the report provides margin analysis that shows how closely your product passed or failed each test.

The D-PHY conformance test software performs a wide range of tests required to meet the physical layer requirements per Section 9 of the MIPI Alliance Specification for D-PHY v1.2 and Section 1 of the D-PHY Conformance Test Suite (CTS) v1.2. The D-PHY conformance test software helps you execute the most difficult physical layer tests for transmitters (TX tests only) that can be measured with a 4-GHz or higher-bandwidth real-time oscilloscope. Although there are not currently any requirements for physical layer compliance verification, it is highly recommended that every MIPI D-PHY link be tested against the limits of the physical layer specification to ensure that it is compliant to the specification and to minimize concerns with protocol level interoperability.

### Features

The D-PHY conformance test software offers several features to simplify design validation:

- Complete MIPI Alliance Specification for D-PHY v1.2, section 9 and D-PHY CTS v1.2, section 1
- User selection of tests and configuration of data rate
- Automated scope measurement setup and programming for increased accuracy, time-savings and repeatability
- Advanced debug modes for troubleshooting
- Automated margin analysis and pass/fail conformance reporting

With the D-PHY conformance test software, you can use the same oscilloscope you use for everyday debugging to perform automated testing and margin analysis based on the MIPI Alliance Specification for D-PHY v1.2, section 9 requirements and D-PHY CTS v1.2, section 1.

## D-PHY App Saves You Time

The D-PHY conformance test software saves you time by setting the stage for automatic execution of required electrical tests. The primary difficulty of performing electrical tests for D-PHY is connecting the oscilloscope to the target device, correctly configuring the scope's measurement system for ultimate accuracy, issuing the proper commands to perform the tests and then analyzing the measured results by comparing them to limits published in the specification. The D-PHY conformance test software automates this work to provide rapid, accurate and repeatable test execution. In addition, if you discover a problem with your product, debug tools in the scope are available to aid in root-cause analysis.

See Table 1 for a complete list of the measurements you can make with the D-PHY conformance test software.

## Easy Test Definition

The D-PHY conformance test software extends the ease-of-use advantages of Keysight's Infiniium oscilloscopes to testing D-PHY designs. The Keysight automated test engine walks you quickly through the steps required to define and configure the tests, execute the tests, and view the test results. You can select a category of tests all at once or specify individual tests. The user interface is oriented to minimize unnecessary reconnections, which saves time and ensures accuracy and repeatability of tests. You can save tests and configurations as project files and recall them later for quick re-testing or review of previous test. Straightforward menus let you perform tests with a minimum of mouse clicks.

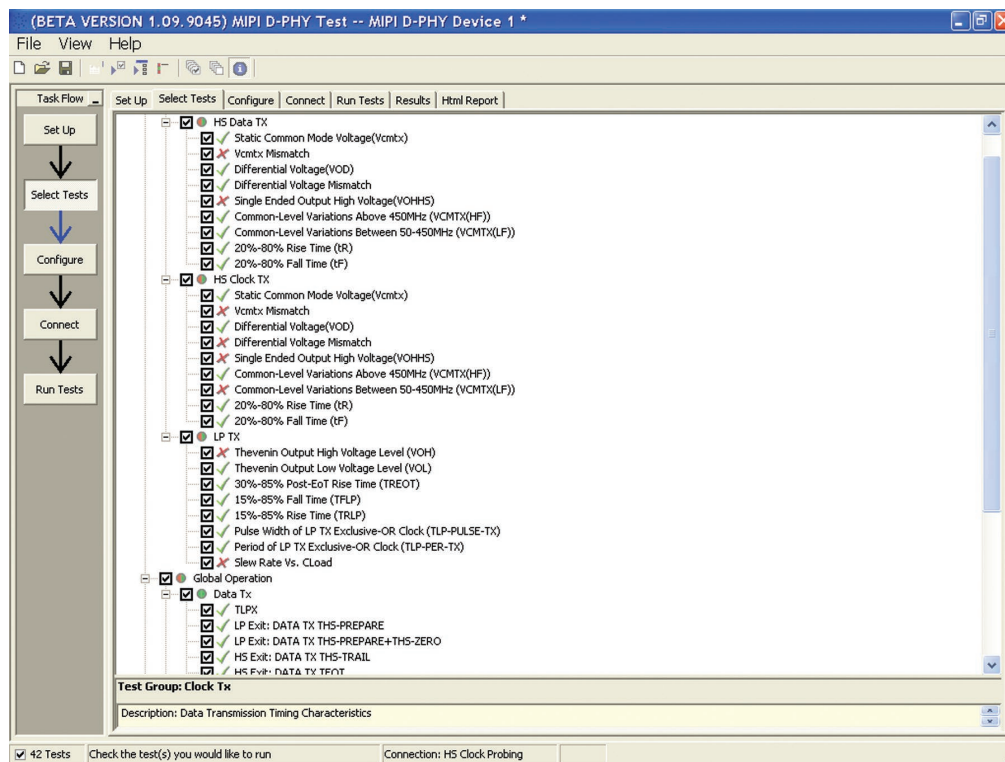

Figure 1. You can easily select individual tests or groups of test with a mouse-click and customize your output report based on the test results you want to see.

## Configurability and Guided Connections

The D-PHY conformance test software provides flexibility in your test setup. The D-PHY conformance test software provides you with user-defined controls for critical test parameters such as channel probe configurations, number of measurement observations for tests and the low-power trigger threshold. After you configure the tests to meet your needs, the D-PHY user interface will present you the connection screen that is specific to the configuration data you have selected. This includes the oscilloscope channels used for the test and the routing of any necessary probing needed to perform the tests. In some cases, a configuration change may be necessary to properly make a new set of measurements. Guided configuration diagrams will be presented when each change is needed to ensure proper configuration for the tests. The software is designed to minimize connection changes to increase the efficiency of test operation and save you time.

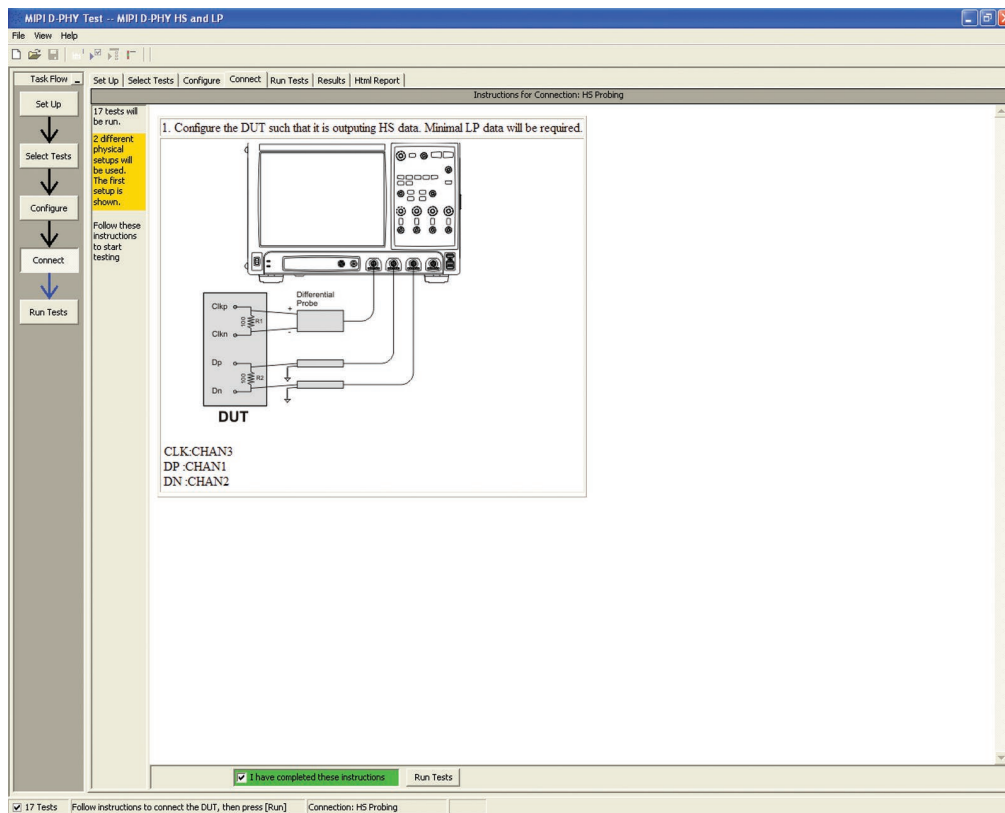

Figure 2. Guided configuration diagrams provide you with channel and probe configurations needed to properly connect to your product and accurately perform tests.

## Results Reports with Margin Analysis

In addition to providing you with measurement results, the D-PHY test software provides a report format that shows you not only where your product passes or fails, but also reports how close you are to the limits specified for a particular test assertion. You select the margin test report parameter, which means you can specify the level at which warnings are issued to alert you to the electrical tests where your product is operating close to the official test limit defined by the specification for a given test assertion.

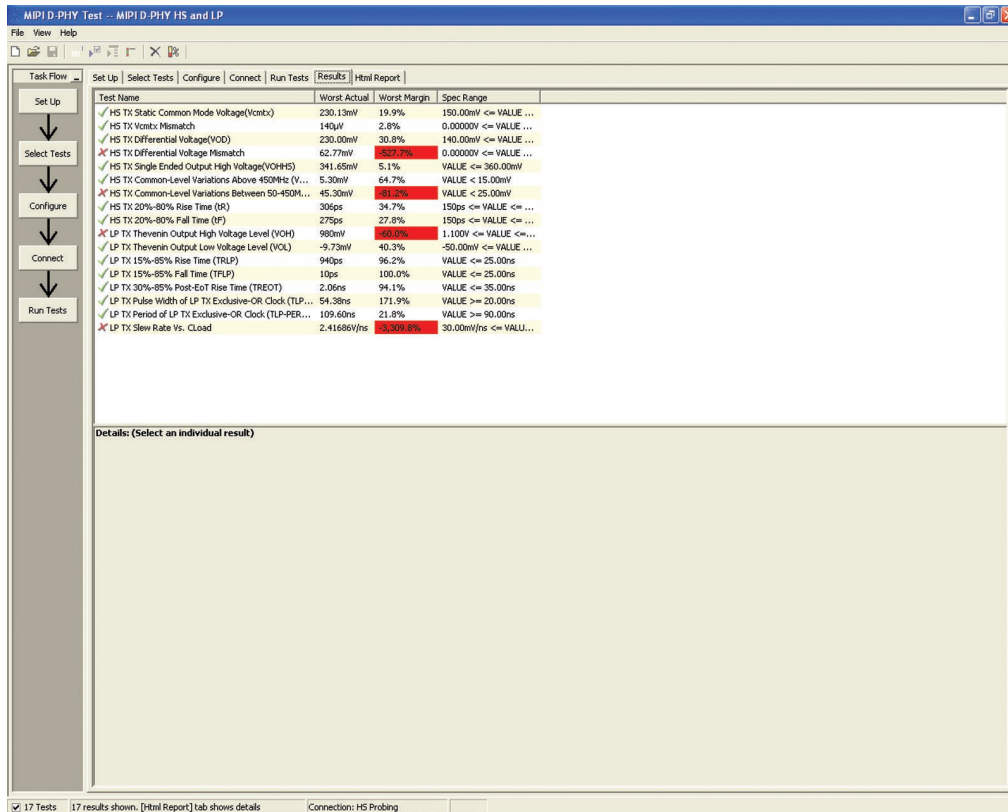

Figure 3. Results reports quickly highlight test margins versus specified limits and a summary of measurements that pass/fail or violate the margin warnings you have set.

## Configurability and Guided Connections

The D-PHY conformance software generates thorough reports that not only capture the performance and status of the device under test, but capture the screen shots of your most significant measurements for your documentation and evaluation.

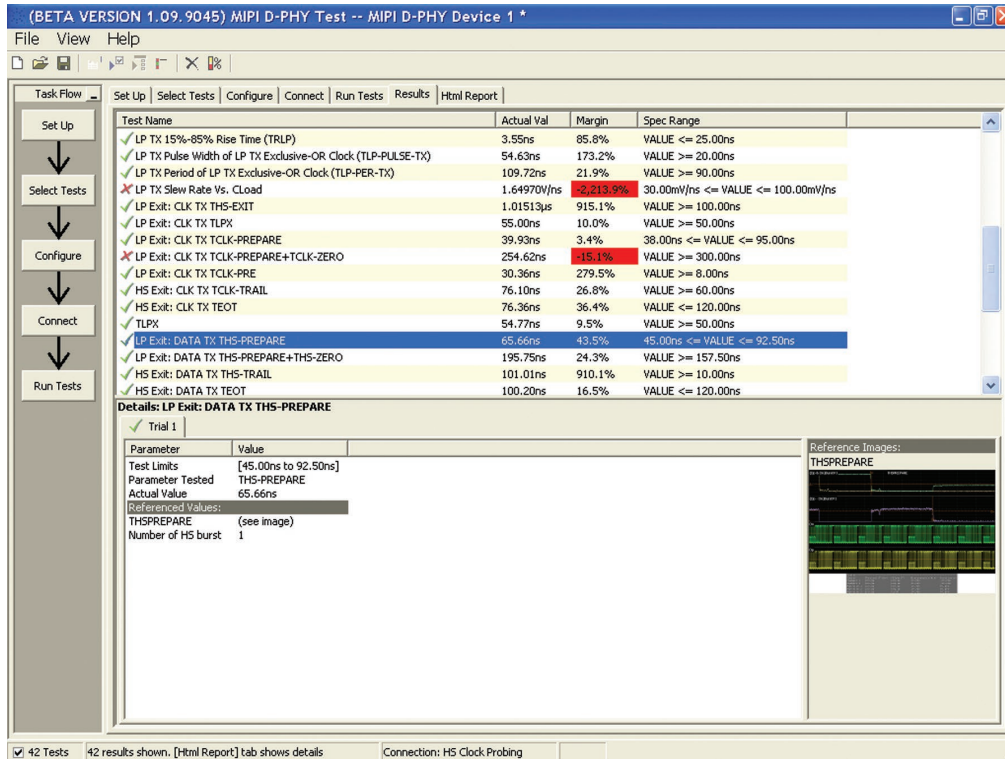

Figure 4. A complete HTML-formatted report provides a results summary for documentation and archiving with full detail on measurement definitions referenced to the specification and screen images from the oscilloscope during test.

## Extensibility

You may add additional custom tests or steps to your application using the N5467B/N5467C User Defined Application (UDA) development tool ([www.keysight.com/find/uda](http://www.keysight.com/find/uda)). Use UDA to develop functional “Add-Ins” that you can plug into your application.

Add-ins may be designed as:

- Complete custom tests (with configuration variables and connection prompts)
- Any custom steps such as pre or post processing scripts, external instrument control and your own device control

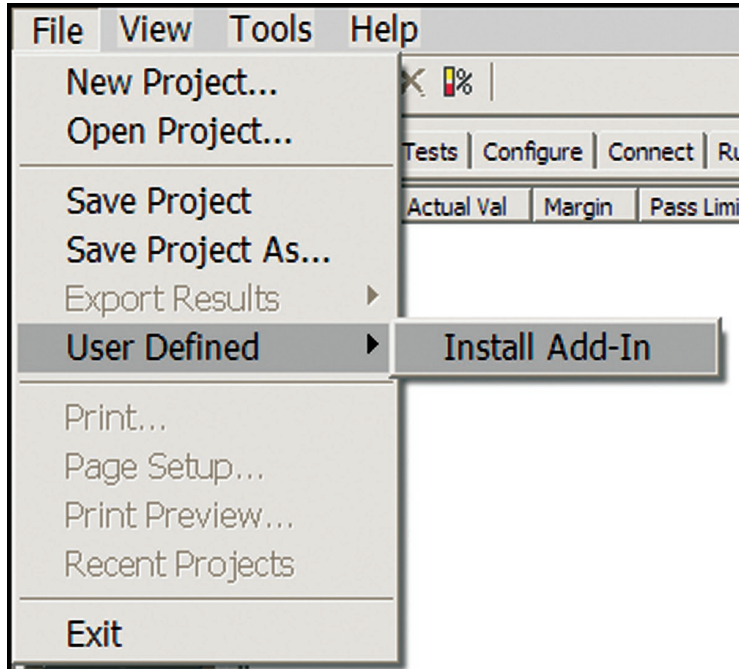

Figure 5. Importing a UDA Add-In into your test application.

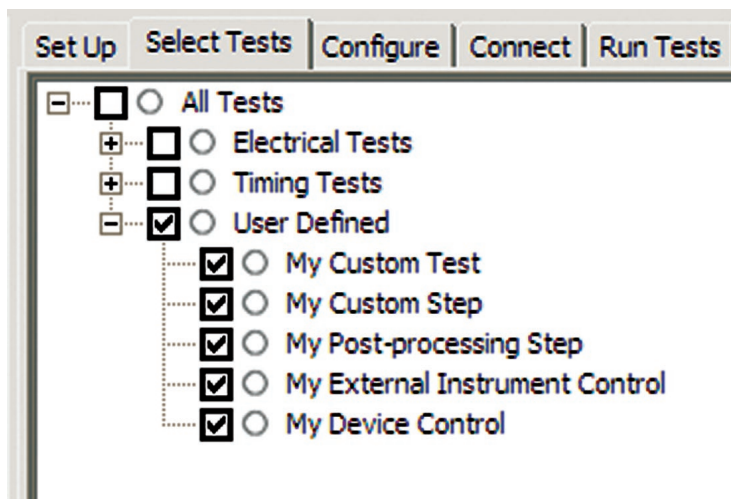

Figure 6. UDA Add-In tests and utilities in your test application.

## Automation

You can completely automate execution of your application's tests and Add-Ins from a separate PC using the included N5452A Remote Interface feature (download free toolkit from [www.keysight.com/find/scope-apps-sw](http://www.keysight.com/find/scope-apps-sw)). You can even create and execute automation scripts right inside the application using a convenient built-in client.

The commands required for each task may be created using a command wizard or from "remote hints" accessible throughout the user interface.

Using automation, you can accelerate complex testing scenarios and even automate manual tasks such as:

- Opening projects, executing tests and saving results
- Executing tests repeatedly while changing configurations
- Sending commands to external instruments
- Executing tests out of order

Combine the power of built-in automation and extensibility to transform your application into a complete test suite executive:

- Interact with your device controller to place it into desired states or test modes before test execution
- Configure additional instruments used in your test suite such as a pattern generator and probe switch matrix
- Export data generated by your tests and post-process it using your favorite environment, such as MATLAB, Python, LabVIEW, C, C++, Visual Basic etc.
- Sequence or repeat the tests and "Add-In" custom steps execution in any order for complete test coverage of the test plan

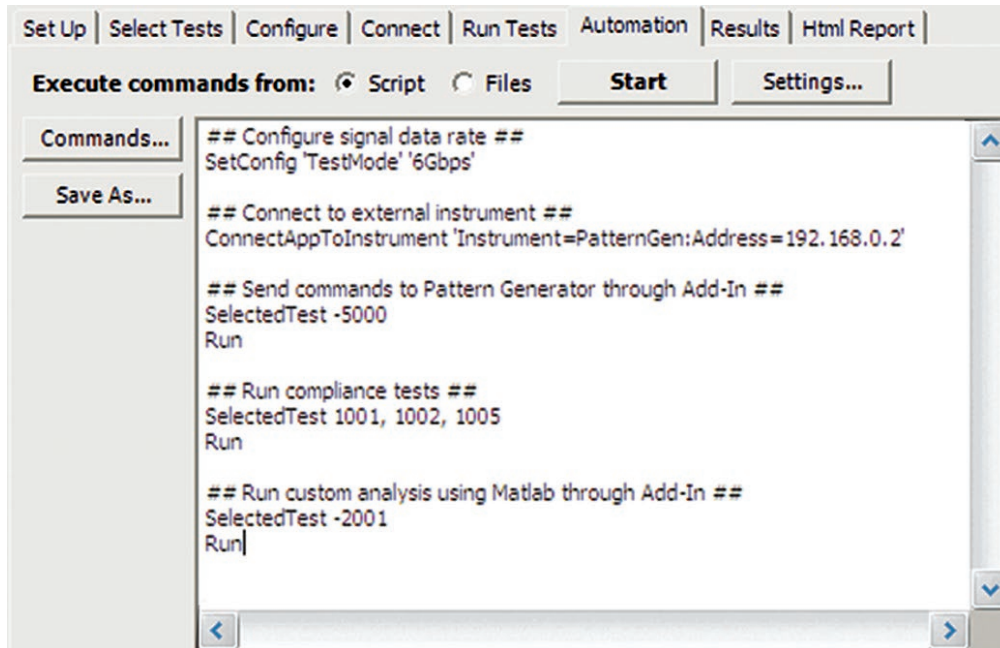

Figure 7. Remote Programming script in the Automation tab.



## Automation (Continued)

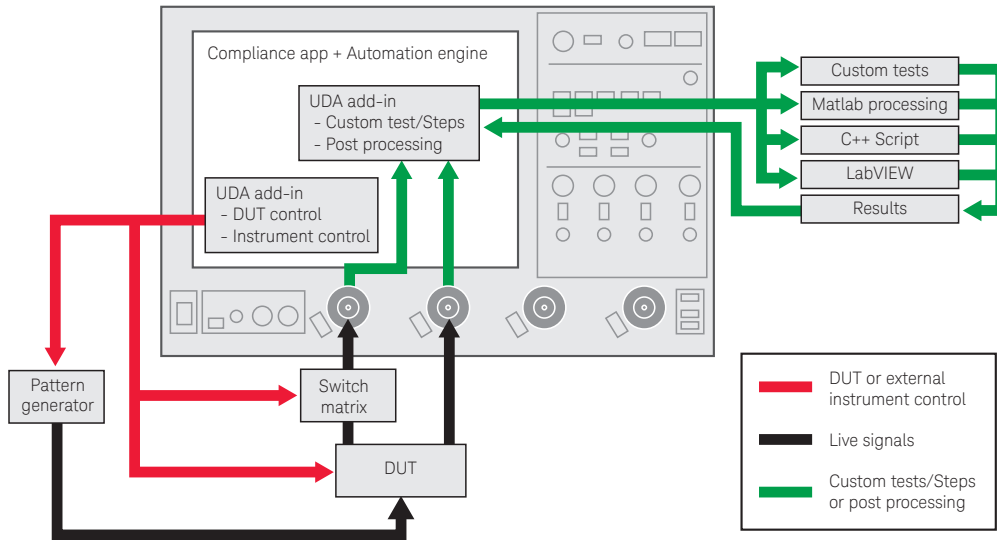

Figure 8. Combine the power of built-in automation and extensibility to transform your application into a complete test suite executive.

## Switch Matrix

The Keysight switch matrix software option for the conformance application, used together with switch matrix hardware, enables fully automated testing for multi-lane digital bus interfaces. The benefits of this automated switching solution include:

- *Eliminate reconnections*, which saves time and reduces errors through automating test setup for each lane of a multi-lane bus
- *Maintain accuracy* with the use of unique PrecisionProbe or InfiniiSim features to compensate for switch path losses and skew
- *Customize testing* by using remote programming interface and the UDA tool for device control, instrument control and test customization

More information of the switching solution and configuration, visit [www.keysight.com/find/switching](http://www.keysight.com/find/switching) and the Keysight application note with the publication number 5991-2375EN.



Figure 9. Automated testing for multi-lane digital bus interface through switching solution.

## Measurement Requirements

To use the D-PHY conformance software you will need a Keysight Infiniium Series oscilloscope with at least 4 GHz of analog, real-time bandwidth. In order to use the D-PHY conformance test software, your product will need to be able to source the necessary low-power (LP) to high-speed (HS) data transitions needed to perform the testing.

## Tests Performed

The D-PHY conformance software performs the following tests as per MIPI Alliance Specification for D-PHY v1.2, section 9 and D-PHY CTS v1.2, section 1.

### MIPI D-PHY CTS section 1, TX timers and signaling

#### High-speed data and clock measurements

- HS data and clock TX static common-mode voltage (VCMTX)
- HS data and clock TX VCMTX mismatch ( $\Delta$ VCMTX(1,0))
- HS data and clock TX differential voltage (VOD)
- HS data and clock TX differential voltage mismatch ( $\Delta$ VOD)
- HS data and clock TX single-ended output high voltage (VOHHS)
- HS data and clock TX common-level variations above 450 MHz (VCMTX(HF))
- HS data and clock TX common-level variations between 50-450 MHz (VCMTX(LF))
- HS data and clock TX 20%-80% rise time (tR)
- HS data and clock TX 20%-80% fall time (tF)
- HS clock instantaneous (UI INST)

#### Low-power data measurements

- LP TX Thevenin output high voltage level (VOH)
- LP TX Thevenin output low voltage (VOL)
- LP TX 15 to 85% rise time (tRLP)
- LP TX 15 to 85% fall time (tFLP)
- LP TX 30 to 85% post-EoT rise time (tREOT)
- LP TX pulse width of LP TX exclusive-OR clock (TLP-PULSE-TX)
- LP TX period of LP TX exclusive-OR clock (TLP-PER-TX)
- LP TX slew rate vs. CLOAD

#### Global operation data and clock TX measurements

- TLPX
- LP exit: Data TX THS-prepare
- LP exit: Data TX THS-prepare+THS-zero
- HS exit: Data TX THS-trail
- HS exit: Data TX TEOT
- HS exit: Data TX THS-exit
- LP exit: Clock TX THS-exit
- LP exit: Clock TX TLPX
- LP exit: Clock TX TCLK-prepare
- LP exit: Clock TX TCLK-prepare+TCLK-zero
- LP exit: Clock TX TCLK-PRE
- LP exit: Clock TX TCLK-trail
- LP exit: Clock TC TX TEOT

#### HS data-clock timing

- HS clock instantaneous
- HS clock rising edge alignment to first payload bit
- Data-to-clock skew (TSKEW(TX))

Table 1. MIPI D-PHY electrical conformance tests performed by the software.

## Recommended Oscilloscopes

The D-PHY compliance software is compatible with Keysight Infiniium Series oscilloscopes with operating software revision 5.50 or higher. For oscilloscopes with earlier revisions, free upgrade software is available here: [www.keysight.com/find/scope-apps-sw](http://www.keysight.com/find/scope-apps-sw).

| Data rate      | Minimum bandwidth | Minimum channels | Compatible oscilloscopes                               |
|----------------|-------------------|------------------|--|
| Up to 1 Gbps   | 4 GHz             | 3                | Infiniium 9000, S-Series, 90000, V-Series and Z-Series |
| Up to 1.5 Gbps | 6 GHz             | 3                | Infiniium 90000, V-Series and Z-Series                 |
| Up to 2.5 Gbps | 12 GHz            | 3                | Infiniium 90000, V-Series and Z-Series                 |

## Ordering Information

To purchase the D-PHY software with a new or existing Infiniium Series oscilloscope, order the following options.

### Software options

| Application   | License type |                   | Infiniium V-Series and Z-Series | Infiniium S-Series | Infiniium 90000 Series    | Infiniium 9000 Series     |
|---|--------------|-------------------|---------------------------------|--------------------|---------------------------|---------------------------|
| D-PHY conformance software                          | Fixed        | Factory-installed | U7238C-1FP                      | U7238D-1FP         | Option 035                | Option 035                |
|   |              | User-installed    | U7238C-1FP                      | U7238D-1FP         | U7238C-1NL                | U7238D-1NL                |
|   | Floating     | Transportable     | U7238C-1TP                      | U7238D-1TP         | U7238C-1TP <sup>1,2</sup> | U7238D-1TP <sup>1,2</sup> |
|   |              | Server-based      | N5435A-022                      | N5435A-022         | N5435A-022                | N5435A-022                |
| D-PHY switch matrix support (optional) <sup>3</sup> | Fixed        | Factory-installed | U7238C-7FP                      | U7238D-7FP         | Option 703                | -                         |
|   |              | User-installed    | U7238C-7FP                      | U7238D-7FP         | U7238C-7NL                | U7238D-7NL                |
|   | Floating     | Transportable     | U7238C-7TP                      | U7238D-7TP         | U7238C-7TP <sup>1,2</sup> | U7238D-7TP <sup>1,2</sup> |
|   |              | Server-based      | N5435A-703                      | N5435A-703         | N5435A-703                | N5435A-703                |
| PrecisionProbe (optional)                           | Fixed        | Factory-installed | N2809A-1FP                      | N2808A-1FP         | Option 001                | -                         |
|   |              | User-installed    | N2809A-1FP                      | N2808A-1FP         | N2809A-1NL                | N2808A-1NL                |
|   | Floating     | Transportable     | N2809A-1TP                      | N2808A-1TP         | N2809A-1TP <sup>1,2</sup> | N2808A-1TP <sup>1,2</sup> |
|   |              | Server-based      | N5435A-003                      | N5435A-003         | N5435A-003                | N5435A-003                |

- Requires software 5.50 and above.
- Software 4.30 or above requires Windows 7. N2753A Infiniium Windows XP to 7 OS upgrade kit (oscilloscope already has M890 motherboard). N2754A Infiniium Windows XP to 7 OS and M890 motherboard upgrade kit (oscilloscope without M890 motherboard). Verify the M890 motherboard using the procedure found in the Windows 7 upgrade kit data sheet with the publication number 5990-8569EN.
- For full switch configuration, refer to [www.keysight.com/find/switching](http://www.keysight.com/find/switching) or the brochure Automated Switching Solution for Oscilloscopes with the publication number 5991-2413EN.

### Other hardware, probes and accessories

| Model number       | Description  | Quantity |
|--------------------|--|----------|
| 1169A <sup>4</sup> | InfiniiMax II 12 GHz differential probe amplifier  | 4        |
| E2669A             | Differential probe connectivity kit (contains needed probe heads)  | 1        |
| RTB                | MIPI D-PHY Reference Termination Board from UNH-IOL<br><a href="https://www.iol.unh.edu/services/testing/mipi/fixtures.php">https://www.iol.unh.edu/services/testing/mipi/fixtures.php</a> | 1        |

- InfiniiMax I and II probes are suitable for D-PHY probing but not InfiniiMax III probes.

## Related Literature

| Publication title   | Publication number |
|---|--------------------|
| <i>N5990A Test Automation Software Platform - Data Sheet</i>    | 5989-5483EN        |
| <i>MIPI D-PHY Protocol Test Solutions - Data Sheet</i>          | 5989-7921EN        |
| <i>PrecisionProbe for Bandwidths up to 33 GHz - Data Sheet</i>  | 5990-7940EN        |
| <i>30 Things Only Infiniium Oscilloscopes Can Do - Brochure</i> | 5991-3958EN        |
| <i>Next-Generation Infiniium User Interface - Brochure</i>      | 5991-3864EN        |

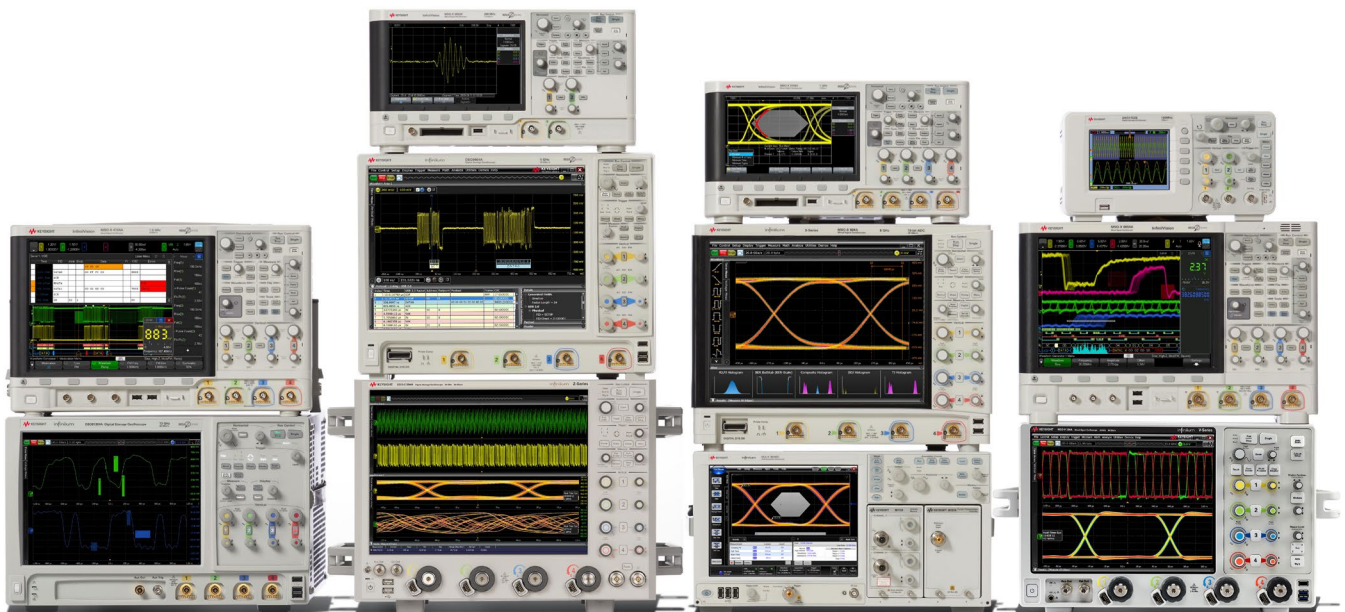

## Keysight Oscilloscopes

Multiple form factors from 20 MHz to > 90 GHz | Industry leading specs | Powerful applications



[www.axiestandard.org](http://www.axiestandard.org)

AdvancedTCA® Extensions for Instrumentation and Test (AXIe) is an open standard that extends the AdvancedTCA for general purpose and semiconductor test. Keysight is a founding member of the AXIe consortium. ATCA®, AdvancedTCA®, and the ATCA logo are registered US trademarks of the PCI Industrial Computer Manufacturers Group.



[www.lxistandard.org](http://www.lxistandard.org)

LAN eXtensions for Instruments puts the power of Ethernet and the Web inside your test systems. Keysight is a founding member of the LXI consortium.



[www.pxisa.org](http://www.pxisa.org)

PCI eXtensions for Instrumentation (PXI) modular instrumentation delivers a rugged, PC-based high-performance measurement and automation system.

## From Hewlett-Packard through Agilent to Keysight

For more than 75 years, we've been helping you unlock measurement insights. Our unique combination of hardware, software and people can help you reach your next breakthrough. **Unlocking measurement insights since 1939.**



1939

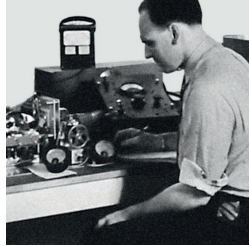

THE FUTURE

For more information on Keysight Technologies' products, applications or services, please contact your local Keysight office. The complete list is available at: [www.keysight.com/find/contactus](http://www.keysight.com/find/contactus)

### Americas

|               |                  |
|---------------|------------------|
| Canada        | (877) 894 4414   |
| Brazil        | 55 11 3351 7010  |
| Mexico        | 001 800 254 2440 |
| United States | (800) 829 4444   |

### Asia Pacific

|                    |                |
|--------------------|----------------|
| Australia          | 1 800 629 485  |
| China              | 800 810 0189   |
| Hong Kong          | 800 938 693    |
| India              | 1 800 11 2626  |
| Japan              | 0120 (421) 345 |
| Korea              | 080 769 0800   |
| Malaysia           | 1 800 888 848  |
| Singapore          | 1 800 375 8100 |
| Taiwan             | 0800 047 866   |
| Other AP Countries | (65) 6375 8100 |

### Europe & Middle East

|                |               |
|----------------|---------------|
| Austria        | 0800 001122   |
| Belgium        | 0800 58580    |
| Finland        | 0800 523252   |
| France         | 0805 980333   |
| Germany        | 0800 6270999  |
| Ireland        | 1800 832700   |
| Israel         | 1 809 343051  |
| Italy          | 800 599100    |
| Luxembourg     | +32 800 58580 |
| Netherlands    | 0800 0233200  |
| Russia         | 8800 5009286  |
| Spain          | 800 000154    |
| Sweden         | 0200 882255   |
| Switzerland    | 0800 805353   |
|                | Opt. 1 (DE)   |
|                | Opt. 2 (FR)   |
|                | Opt. 3 (IT)   |
| United Kingdom | 0800 0260637  |

For other unlisted countries:  
[www.keysight.com/find/contactus](http://www.keysight.com/find/contactus)  
(BP-02-10-16)



[www.keysight.com/go/quality](http://www.keysight.com/go/quality)  
Keysight Technologies, Inc.  
DEKRA Certified ISO 9001:2015  
Quality Management System

This information is subject to change without notice.  
© Keysight Technologies, 2013 - 2016  
Published in USA, March 25, 2016  
5991-2400EN  
[www.keysight.com](http://www.keysight.com)

### myKeysight

myKeysight

[www.keysight.com/find/mykeysight](http://www.keysight.com/find/mykeysight)

A personalized view into the information most relevant to you.

### Three-Year Warranty

[www.keysight.com/find/ThreeYearWarranty](http://www.keysight.com/find/ThreeYearWarranty)

Keysight's committed to superior product quality and lower total cost of ownership. Keysight is the only test and measurement company with three-year warranty standard on all instruments, worldwide. And, we provide a one-year warranty on many accessories, calibration devices, systems and custom products.



### Keysight Assurance Plans

[www.keysight.com/find/AssurancePlans](http://www.keysight.com/find/AssurancePlans)

Up to ten years of protection and no budgetary surprises to ensure your instruments are operating to specification, so you can rely on accurate measurements.



### Keysight Infoline

[www.keysight.com/find/service](http://www.keysight.com/find/service)

Keysight Infoline

Keysight's insight to best in class information management. Free access to your Keysight equipment company reports and e-library.

### Keysight Channel Partners

[www.keysight.com/find/channelpartners](http://www.keysight.com/find/channelpartners)

Get the best of both worlds: Keysight's measurement expertise and product breadth, combined with channel partner convenience.

MIPI® service marks and logo marks are owned by MIPI Alliance, Inc. and any use of such marks by Keysight Technologies is under license. Other service marks and trade names are those of their respective owners.



Unlocking Measurement Insights