

HCA65R042E

650V N-Channel Super Junction MOSFET

Features

- Very Low FOM ($R_{DS(on)} \times Q_g$)
- Extremely low switching loss
- Excellent stability and uniformity
- 100% Avalanche Tested
- Higher dv/dt ruggedness

Application

- Telecom Power equipment / Server station
- Uninterruptible Power Supply (UPS)
- Micro Solar Inverter & EV Charger
- Suitable for Hard switching (Full bridge & Half Bridge) and PFC boost demanding high efficiency

Key Parameters

Parameter	Value	Unit
$BV_{DSS} @ T_{j,max}$	700	V
I_D	78	A
$R_{DS(on), max}$	42	m Ω
Q_g, Typ	100	nC

Package & Internal Circuit

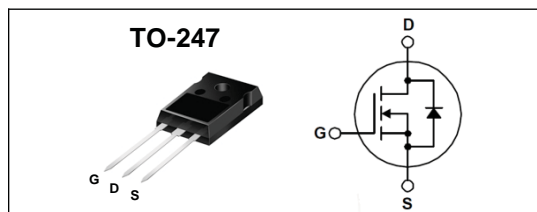

Absolute Maximum Ratings $T_C=25^\circ\text{C}$ unless otherwise specified

Symbol	Parameter	Value	Units
V_{DSS}	Drain-Source Voltage	650	V
V_{GS}	Gate-Source Voltage	± 30	V
I_D	Drain Current – Continuous ($T_C = 25^\circ\text{C}$)	78	A
	Drain Current – Continuous ($T_C = 100^\circ\text{C}$)	49	A
I_{DM}	Drain Current – Pulsed (Note 1)	234	A
E_{AS}	Single Pulsed Avalanche Energy (Note 2)	2800	mJ
dv/dt	MOSFET dv/dt ruggedness, $V_{DS}=0\dots 480\text{V}$	50	V/ns
dv/dt	Reverse diode dv/dt, $V_{DS}=0\dots 480\text{V}$, $I_{DS} \leq I_D$	15	V/ns
P_D	Power Dissipation	480	W
T_J, T_{STG}	Operating and Storage Temperature Range	-55 to +150	$^\circ\text{C}$
T_L	Maximum lead temperature for soldering purposes, 1/8" from case for 5 seconds	300	$^\circ\text{C}$

Thermal Resistance Characteristics

Symbol	Parameter	Typ.	Max.	Units
$R_{\theta JC}$	Junction-to-Case	--	0.26	$^\circ\text{C}/\text{W}$
$R_{\theta JA}$	Junction-to-Ambient	--	40	

Electrical Characteristics $T_J=25\text{ }^\circ\text{C}$ unless otherwise specified

Symbol	Parameter	Test Conditions	Min	Typ	Max	Units
On Characteristics						
V_{GS}	Gate Threshold Voltage	$V_{DS} = V_{GS}, I_D = 2\text{ mA}$	2.5	--	4.5	V
$R_{DS(ON)}$	Static Drain-Source On-Resistance	$V_{GS} = 10\text{ V}, I_D = 39\text{ A}$	--	38	42	m Ω
Off Characteristics						
BV_{DSS}	Drain-Source Breakdown Voltage	$V_{GS} = 0\text{ V}, I_D = 1\text{ mA}$	650	--	--	V
I_{DSS}	Zero Gate Voltage Drain Current	$V_{DS} = 650\text{ V}, V_{GS} = 0\text{ V}$	--	--	1	μA
		$V_{DS} = 520\text{ V}, T_J = 125\text{ }^\circ\text{C}$	--	--	100	μA
I_{GSS}	Gate-Body Leakage Current	$V_{GS} = \pm 30\text{ V}, V_{DS} = 0\text{ V}$	--	--	± 100	nA
Dynamic Characteristics						
C_{iss}	Input Capacitance	$V_{DS} = 50\text{ V}, V_{GS} = 0\text{ V},$ $f = 1.0\text{ MHz}$	--	7200	--	pF
C_{oss}	Output Capacitance		--	410	--	pF
C_{rss}	Reverse Transfer Capacitance		--	12	--	pF
Switching Characteristics						
$t_{d(on)}$	Turn-On Time	$V_{DS} = 325\text{ V}, I_D = 39\text{ A},$ $R_G = 25\text{ }\Omega$	--	130	--	ns
t_r	Turn-On Rise Time		--	35	--	ns
$t_{d(off)}$	Turn-Off Delay Time		--	250	--	ns
t_f	Turn-Off Fall Time		--	20	--	ns
Q_g	Total Gate Charge	$V_{DS} = 520\text{ V}, I_D = 39\text{ A}$ $V_{GS} = 10\text{ V}$	--	100	130	nC
Q_{gs}	Gate-Source Charge		--	36	--	nC
Q_{gd}	Gate-Drain Charge		--	18	--	nC
Source-Drain Diode Maximum Ratings and Characteristics						
I_S	Continuous Source-Drain Diode Forward Current		--	--	78	A
I_{SM}	Pulsed Source-Drain Diode Forward Current		--	--	234	
V_{SD}	Source-Drain Diode Forward Voltage	$I_S = 39\text{ A}, V_{GS} = 0\text{ V}$	--	--	1.4	V
t_{rr}	Reverse Recovery Time	$I_S = 39\text{ A}, V_{GS} = 0\text{ V}$ $di_F/dt = 100\text{ A}/\mu\text{s}$	--	556	--	ns
Q_{rr}	Reverse Recovery Charge		--	10.8	--	μC

Notes ;

1. Repetitive Rating : Pulse width limited by maximum junction temperature
2. $L=50\text{mH}, V_{DD}=50\text{V}, R_G=25\Omega,$ Starting $T_J=25^\circ\text{C}$
3. Pulse Test : Pulse Width $\leq 300\mu\text{s},$ Duty Cycle $\leq 2\%$

Typical Characteristics

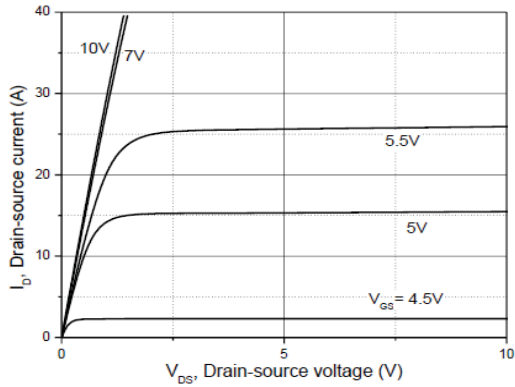

Figure 1. On Region Characteristics

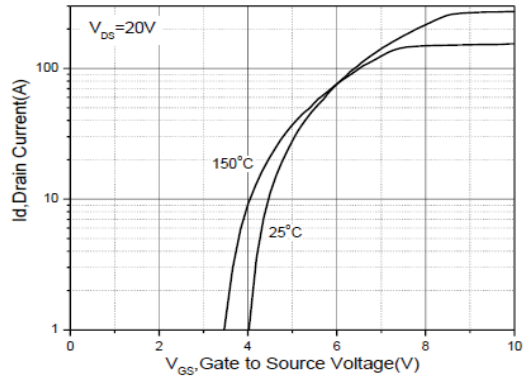

Figure 2. Transfer Characteristics

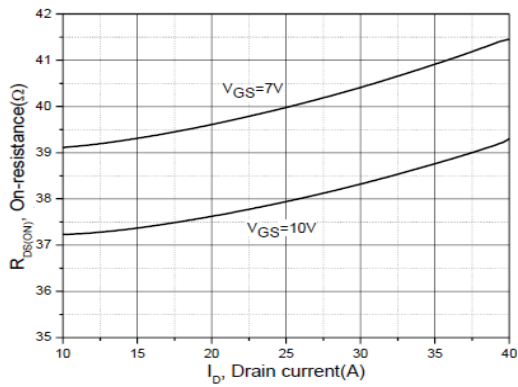

Figure 3. On Resistance Variation vs Drain Current and Gate Voltage

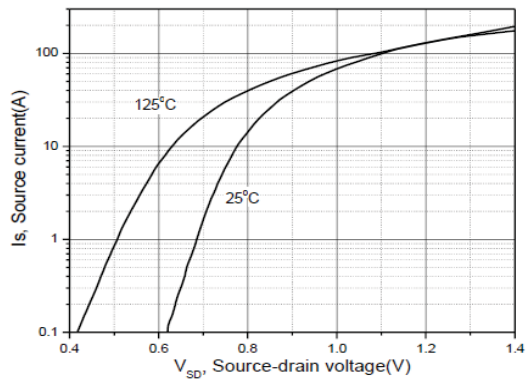

Figure 4. Body Diode Forward Voltage Variation with Source Current and Temperature

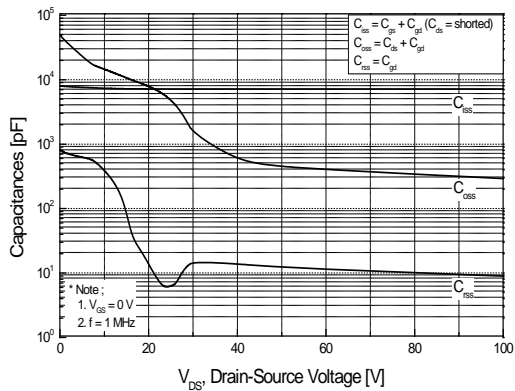

Figure 5. Capacitance Characteristics

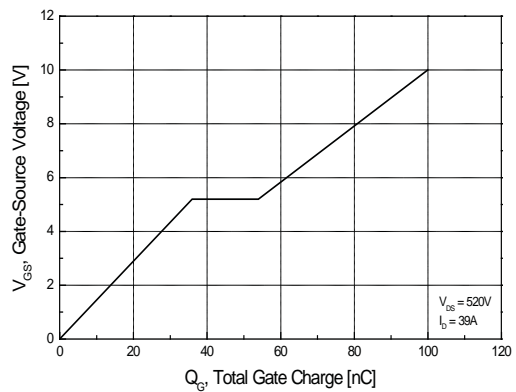

Figure 6. Gate Charge Characteristics

Typical Characteristics (continued)

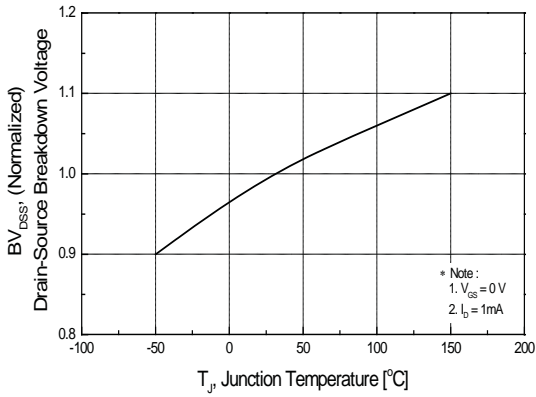

Figure 7. Breakdown Voltage Variation vs Temperature

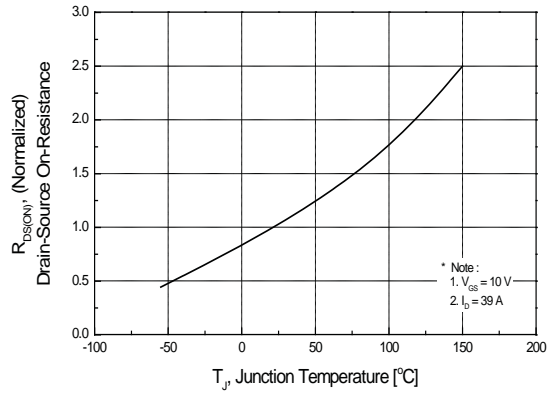

Figure 8. On-Resistance Variation vs Temperature

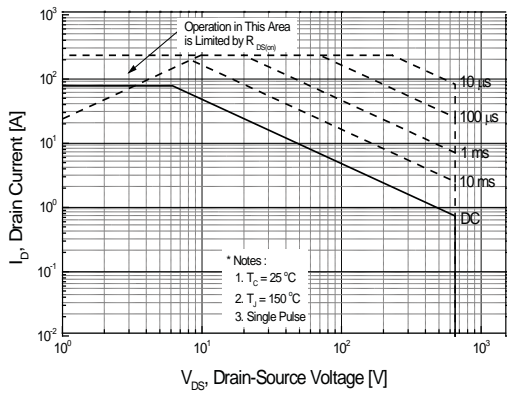

Figure 9. Maximum Safe Operating Area

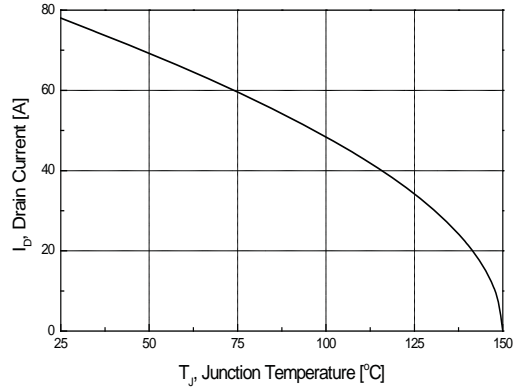

Figure 10. Maximum Drain Current vs Case Temperature

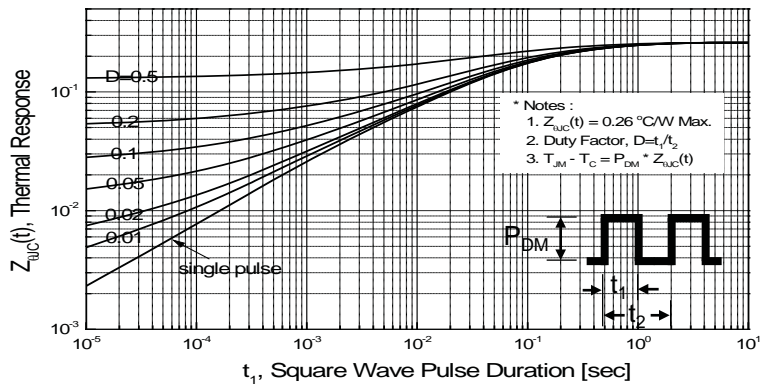

Figure 11. Transient Thermal Response Curve

Fig 12. Gate Charge Test Circuit & Waveform

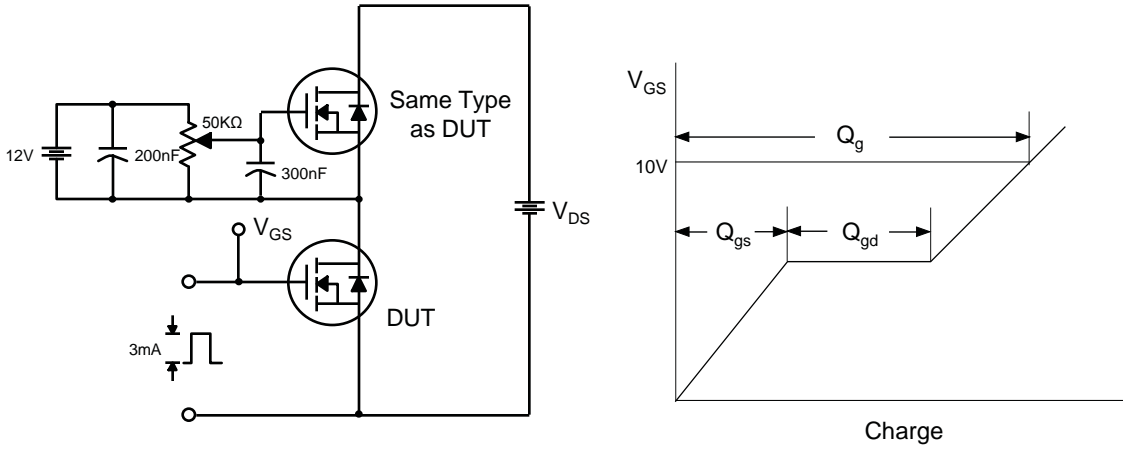

Fig 13. Resistive Switching Test Circuit & Waveforms

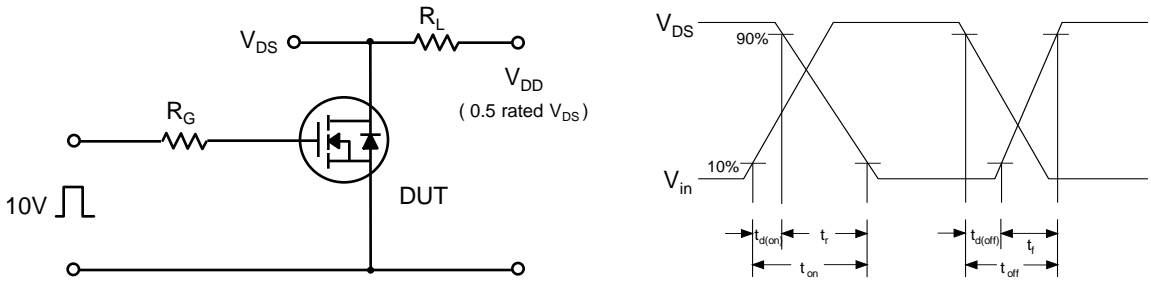

Fig 14. Unclamped Inductive Switching Test Circuit & Waveforms

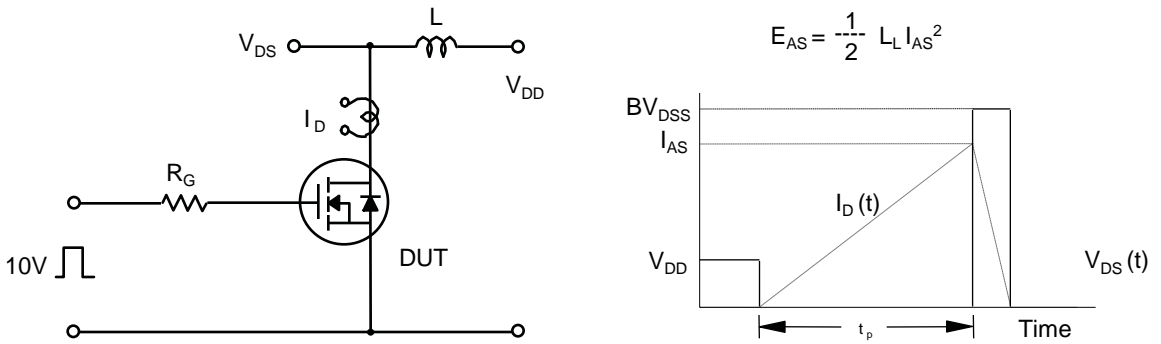
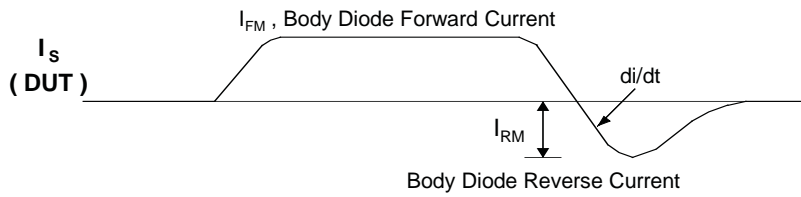
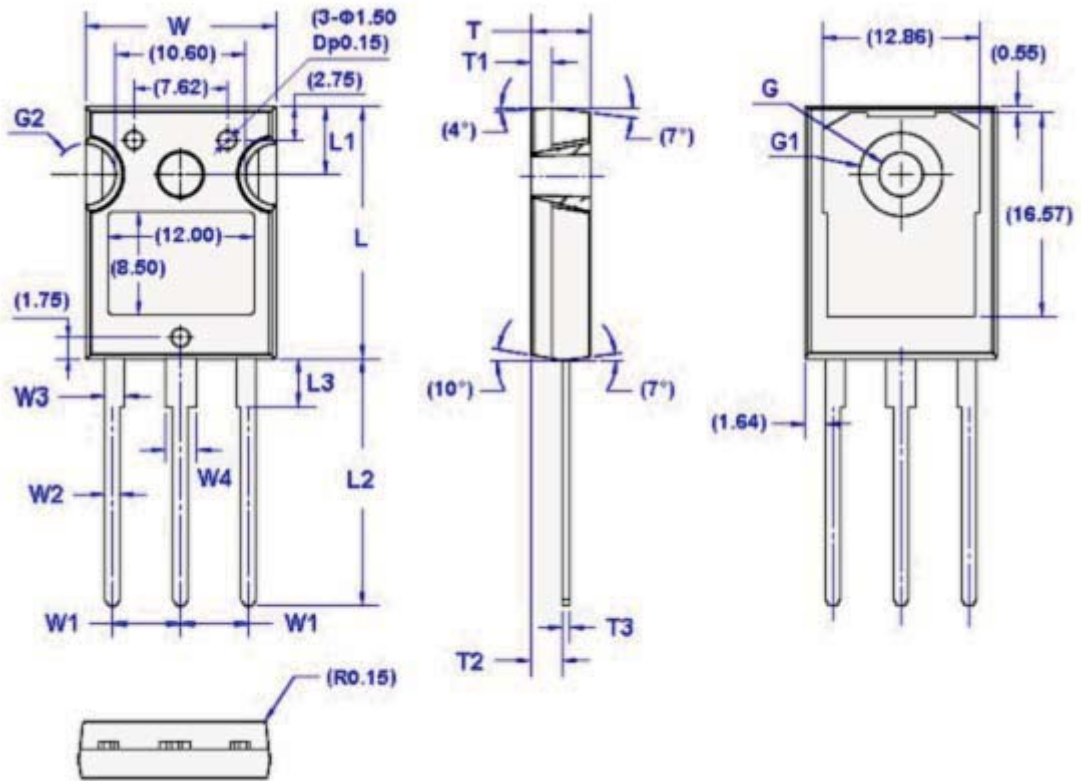

Fig 15. Peak Diode Recovery dv/dt Test Circuit & Waveforms



Package Dimension

TO-247



(Unit : mm)

Symbol	Size		Symbol	Size	
	Min	Max		Min	Max
W	15.4	15.8	W4	2.44	2.64
W1	5.56 (TYP)		L	20.4	20.8
W2	1.17	1.35	L1	5.36	5.56
W3	1.55	1.75	L2	19.8	20.2
L3	3.69	3.93	T3	0.51	0.69
T	4.6	4.8	G(Φ)	3.51	3.65
T1	1.4	1.6	G1(Φ)	6.61	6.85
T2	2.3	2.5	G2(Φ)	4.96	5.2