

COMPLEMENTARY PAIR ENHANCEMENT MODE MOSFET

NEW PRODUCT

Product Summary

Device	V _{(BR)DSS}	R _{DS(ON)} max	I _D max T _A = +25°C
Q1	30V	1.5Ω @ V _{GS} = 4.5V	0.22A
		2.0Ω @ V _{GS} = 2.5V	
		3.0Ω @ V _{GS} = 1.8V	
		4.5Ω @ V _{GS} = 1.5V	
Q2	-30V	5Ω @ V _{GS} = -4.5V	-0.2A
		6Ω @ V _{GS} = -2.5V	
		7Ω @ V _{GS} = -1.8V	
		10Ω @ V _{GS} = -1.5V	

Features and Benefits

- Low On-Resistance
- Very low Gate Threshold Voltage, 1.0V max
- Low Input Capacitance
- Fast Switching Speed
- Ultra-Small Surface Mount Package 1mm x 1mm
- ESD Protected Gate
- **Totally Lead-Free & Fully RoHS Compliant (Notes 1 & 2)**
- **Halogen and Antimony Free. "Green" Device (Note 3)**
- **Qualified to AEC-Q101 standards for High Reliability**

Mechanical Data

- Case: SOT963
- Case Material: Molded Plastic, "Green" Molding Compound. UL Flammability Classification Rating 94V-0
- Moisture Sensitivity: Level 1 per J-STD-020
- Terminal Connections Indicator: See Diagram
- Terminals: Finish — Matte Tin Annealed over Copper Leadframe Solderable per MIL-STD-202, Method 208
- Weight: 0.027 grams (approximate)

Description

This MOSFET has been designed to minimize the on-state resistance (R_{DS(ON)}) and yet maintain superior switching performance, making it ideal for high efficiency power management applications.

Applications

- General Purpose Interfacing Switch
- Power Management Functions
- Analog Switch



SOT963

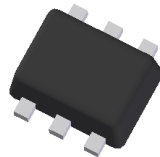

Top View

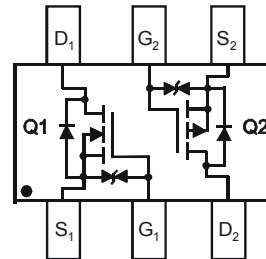

Top View Schematic and Transistor Diagram

Ordering Information (Note 4)

Part Number	Case	Packaging
DMC31D5UDJ-7	SOT963	10K/Tape & Reel
DMC31D5UDJ-7B	SOT963	10K/Tape & Reel

- Notes:
1. No purposely added lead. Fully EU Directive 2002/95/EC (RoHS) & 2011/65/EU (RoHS 2) compliant.
 2. See http://www.diodes.com/quality/lead_free.html for more information about Diodes Incorporated's definitions of Halogen- and Antimony-free, "Green" and Lead-free.
 3. Halogen- and Antimony-free "Green" products are defined as those which contain <900ppm bromine, <900ppm chlorine (<1500ppm total Br + Cl) and <1000ppm antimony compounds.
 4. For packaging details, go to our website at <http://www.diodes.com/products/packages.html>. The options -7 and -7B stand for different taping orientations.

Marking Information

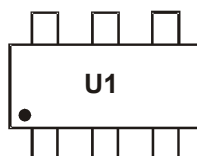

U1 = Product Type Marking Code

Maximum Ratings Q1 N-CHANNEL (@ $T_A = +25^\circ\text{C}$, unless otherwise specified.)

Characteristic	Symbol	Value	Units	
Drain-Source Voltage	V_{DS}	30	V	
Gate-Source Voltage	V_{GS}	± 12	V	
Continuous Drain Current (Note 5) $V_{GS} = 4.5\text{V}$	I_D	Steady State $T_A = +25^\circ\text{C}$ $T_A = +70^\circ\text{C}$	220 160	mA
Maximum Continuous Body Diode Forward Current (Note 6)		I_S	200	mA
Pulsed Drain Current (Note 6)	I_{DM}	600	mA	

Maximum Ratings Q2 P-CHANNEL (@ $T_A = +25^\circ\text{C}$, unless otherwise specified.)

Characteristic	Symbol	Value	Units	
Drain-Source Voltage	V_{DS}	-30	V	
Gate-Source Voltage	V_{GS}	± 12	V	
Continuous Drain Current (Note 5) $V_{GS} = -4.5\text{V}$	I_D	Steady State $T_A = +25^\circ\text{C}$ $T_A = +70^\circ\text{C}$	-200 -140	mA
Maximum Continuous Body Diode Forward Current (Note 6)		I_S	-200	mA
Pulsed Drain Current (Note 6)	I_{DM}	-600	mA	

Thermal Characteristics (@ $T_A = +25^\circ\text{C}$, unless otherwise specified.)

Characteristic	Symbol	Value	Units
Total Power Dissipation (Note 5)	P_D	350	mW
Thermal Resistance, Junction to Ambient (Note 5)	Steady State $R_{\theta JA}$	361	$^\circ\text{C/W}$
Operating and Storage Temperature Range	T_J, T_{STG}	-55 to +150	$^\circ\text{C}$

Electrical Characteristics Q1 N-CHANNEL (@ $T_A = +25^\circ\text{C}$, unless otherwise specified.)

Characteristic	Symbol	Min	Typ	Max	Unit	Test Condition
OFF CHARACTERISTICS (Note 7)						
Drain-Source Breakdown Voltage	BV_{DS}	30	—	—	V	$V_{GS} = 0\text{V}, I_D = 250\mu\text{A}$
Zero Gate Voltage Drain Current	I_{DSS}	—	—	100	nA	@ $T_C = +25^\circ\text{C}$ $V_{DS} = 24\text{V}, V_{GS} = 0\text{V}$
Gate-Source Leakage	I_{GSS}	—	—	± 10	μA	$V_{GS} = \pm 10\text{V}, V_{DS} = 0\text{V}$
ON CHARACTERISTICS (Note 7)						
Gate Threshold Voltage	$V_{GS(th)}$	0.4	—	1.0	V	$V_{DS} = V_{GS}, I_D = 250\mu\text{A}$
Static Drain-Source On-Resistance	$R_{DS(on)}$	—	0.9	1.5	Ω	$V_{GS} = 4.5\text{V}, I_D = 100\text{mA}$
		—	1.0	2.0		$V_{GS} = 2.5\text{V}, I_D = 50\text{mA}$
		—	1.2	3.0		$V_{GS} = 1.8\text{V}, I_D = 20\text{mA}$
		—	1.4	4.5		$V_{GS} = 1.5\text{V}, I_D = 10\text{mA}$
		—	2.3	—		$V_{GS} = 1.2\text{V}, I_D = 1\text{mA}$
Diode Forward Voltage	V_{SD}	—	0.6	1.0	V	$V_{GS} = 0\text{V}, I_S = 10\text{mA}$
DYNAMIC CHARACTERISTICS (Note 8)						
Input Capacitance	C_{iss}	—	22.6	—	pF	$V_{DS} = 15\text{V}, V_{GS} = 0\text{V},$ $f = 1.0\text{MHz}$
Output Capacitance	C_{oss}	—	2.68	—	pF	
Reverse Transfer Capacitance	C_{rss}	—	1.8	—	pF	
Total Gate Charge	Q_g	—	0.38	—	nC	$V_{GS} = 4.5\text{V}, V_{DS} = 15\text{V},$ $I_D = 200\text{mA}$
Gate-Source Charge	Q_{gs}	—	0.05	—	nC	
Gate-Drain Charge	Q_{gd}	—	0.07	—	nC	
Turn-On Delay Time	$t_{D(on)}$	—	3.2	—	ns	$V_{DD} = 15\text{V}, V_{GS} = 4.5\text{V},$ $R_G = 2\Omega, I_D = 200\text{mA}$
Turn-On Rise Time	t_r	—	2.2	—	ns	
Turn-Off Delay Time	$t_{D(off)}$	—	21	—	ns	
Turn-Off Fall Time	t_f	—	7.5	—	ns	

Electrical Characteristics Q2 P-CHANNEL (@T_A = +25°C, unless otherwise specified.)

Characteristic	Symbol	Min	Typ	Max	Unit	Test Condition
OFF CHARACTERISTICS (Note 7)						
Drain-Source Breakdown Voltage	BV _{DSS}	-30	—	—	V	V _{GS} = 0V, I _D = -250μA
Zero Gate Voltage Drain Current	I _{DSS}	—	—	100	nA	@T _C = +25°C V _{DS} = -24V, V _{GS} = 0V
Gate-Source Leakage	I _{GSS}	—	—	±10	μA	V _{GS} = ±10V, V _{DS} = 0V
ON CHARACTERISTICS (Note 7)						
Gate Threshold Voltage	V _{GS(th)}	-0.4	—	-1.0	V	V _{DS} = V _{GS} , I _D = -250μA
Static Drain-Source On-Resistance	R _{DS(on)}	—	2.0	5	Ω	V _{GS} = -4.5V, I _D = -100mA
		—	2.5	6		V _{GS} = -2.5V, I _D = -50mA
		—	3.0	7		V _{GS} = -1.8V, I _D = -20mA
		—	3.4	10		V _{GS} = -1.5V, I _D = -10mA
		—	5.1	—		V _{GS} = -1.2V, I _D = -1mA
Diode Forward Voltage	V _{SD}	—	-0.6	-1.0	V	V _{GS} = 0V, I _S = -10mA
DYNAMIC CHARACTERISTICS (Note 8)						
Input Capacitance	C _{iss}	—	21.8	—	pF	V _{DS} = -15V, V _{GS} = 0V, f = 1.0MHz
Output Capacitance	C _{oss}	—	2.82	—	pF	
Reverse Transfer Capacitance	C _{rss}	—	1.66	—	pF	
Total Gate Charge	Q _g	—	0.35	—	nC	V _{GS} = -4.5V, V _{DS} = -15V, I _D = -200mA
Gate-Source Charge	Q _{gs}	—	0.05	—	nC	
Gate-Drain Charge	Q _{gd}	—	0.10	—	nC	
Turn-On Delay Time	t _{D(on)}	—	3.5	—	ns	V _{DD} = -15V, V _{GS} = -4.5V, R _G = 2Ω, I _D = -200mA
Turn-On Rise Time	t _r	—	5.2	—	ns	
Turn-Off Delay Time	t _{D(off)}	—	18.8	—	ns	
Turn-Off Fall Time	t _f	—	8.7	—	ns	

- Notes:
5. Device mounted on FR-4 PCB, with minimum recommended pad layout.
 6. Device mounted on minimum recommended pad layout test board, 10μs pulse duty cycle = 1%.
 7. Short duration pulse test used to minimize self-heating effect.
 8. Guaranteed by design. Not subject to product testing.

N-CHANNEL

NEW PRODUCT

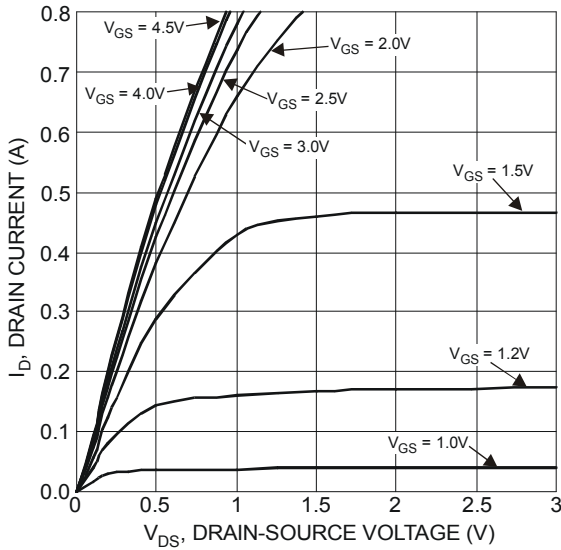

Figure 1 Typical Output Characteristics

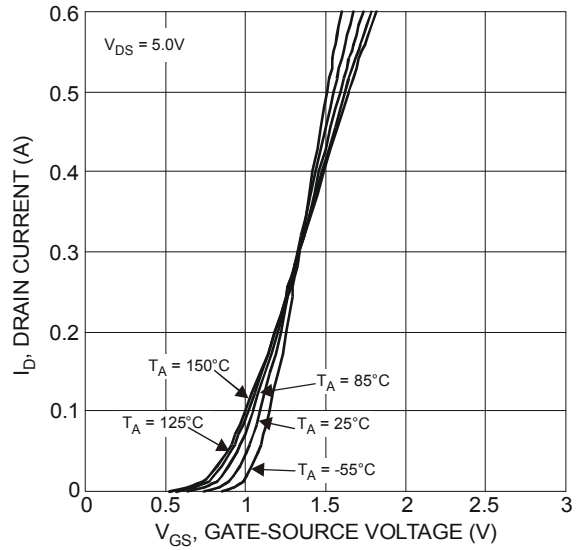

Figure 2 Typical Transfer Characteristics

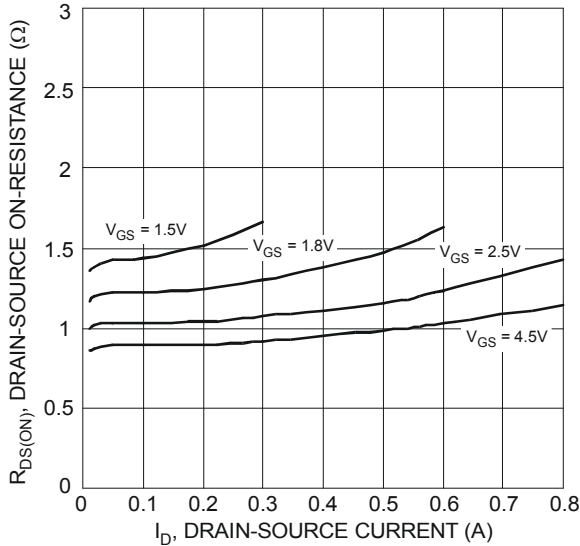

Figure 3 Typical On-Resistance vs. Drain Current and Gate Voltage

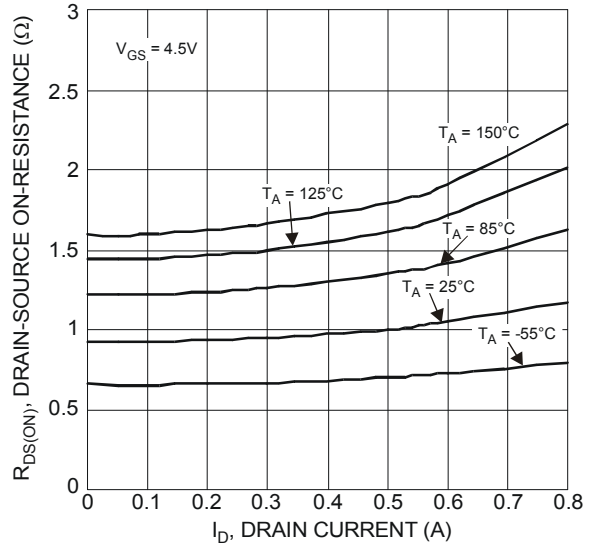

Figure 4 Typical On-Resistance vs. Drain Current and Temperature

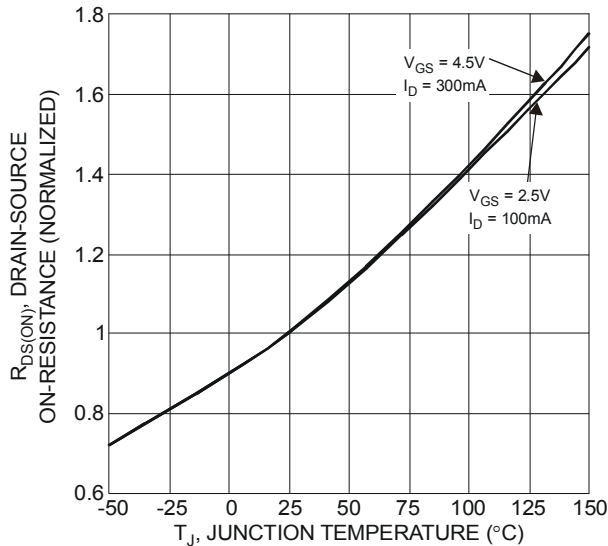

Figure 5 On-Resistance Variation with Temperature

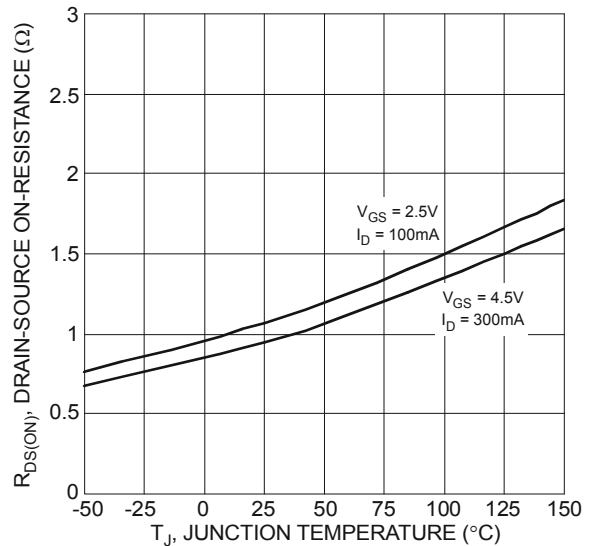

Figure 6 On-Resistance Variation with Temperature

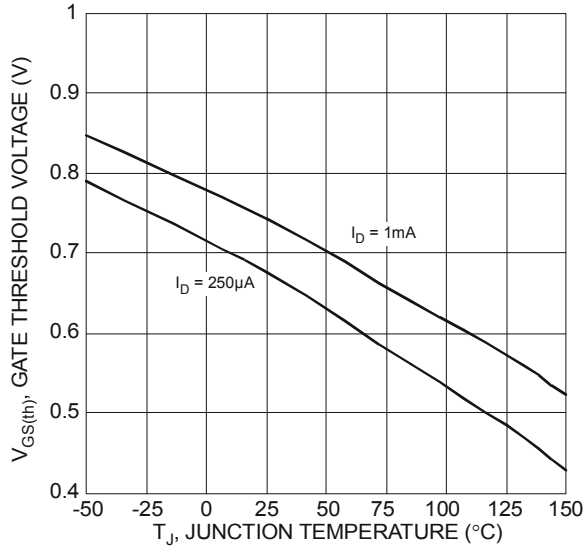

Figure 7 Gate Threshold Variation vs. Ambient Temperature

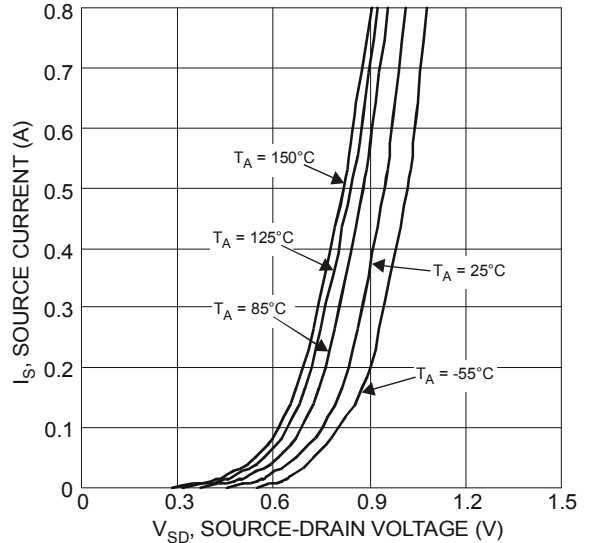

Figure 8 Diode Forward Voltage vs. Current

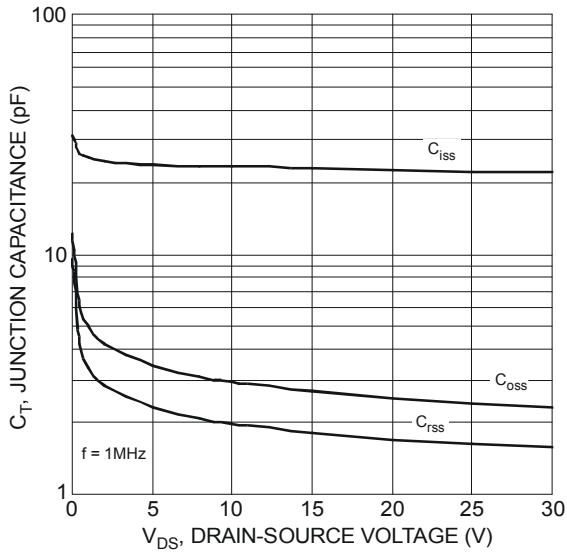

Figure 9 Typical Junction Capacitance

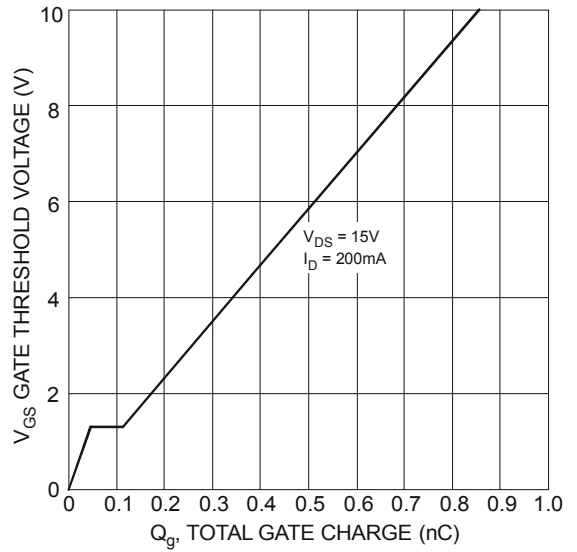

Figure 10 Gate Charge

P-CHANNEL

NEW PRODUCT

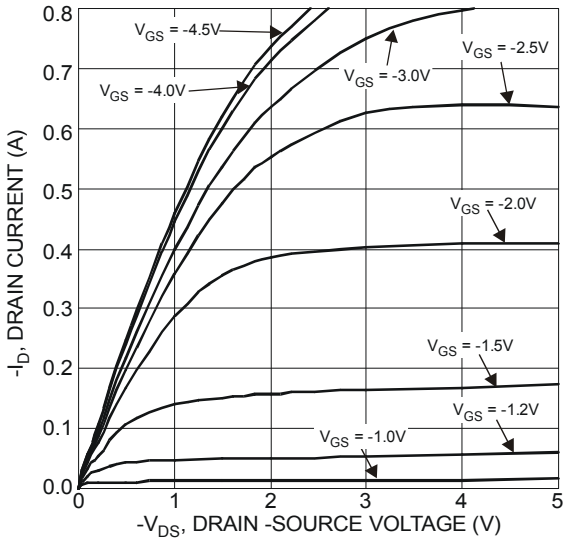

Figure 1 Typical Output Characteristics

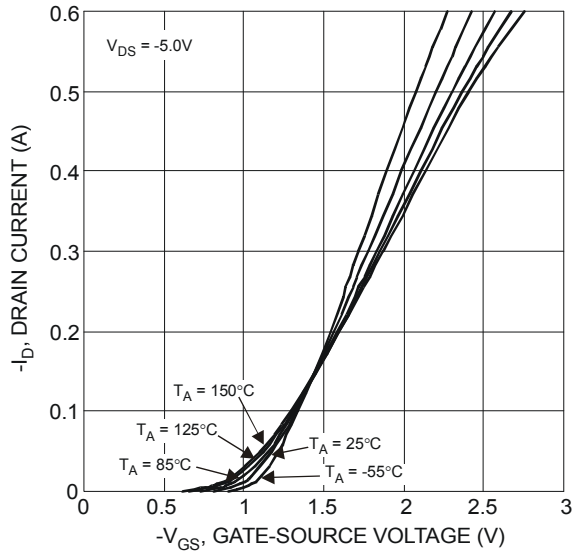

Figure 2 Typical Transfer Characteristics

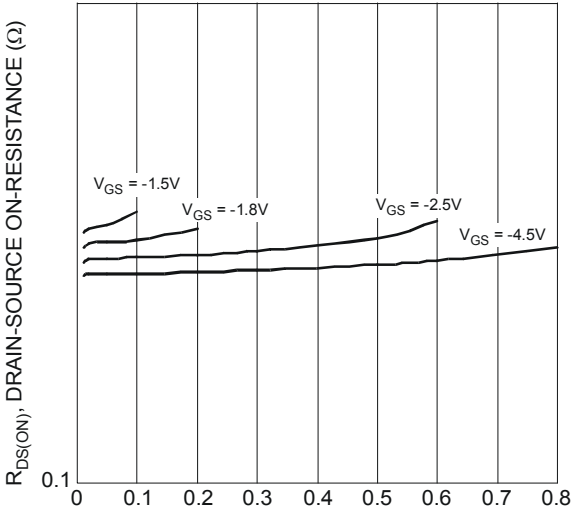

Figure 3 Typical On-Resistance vs. Drain Current and Gate Voltage

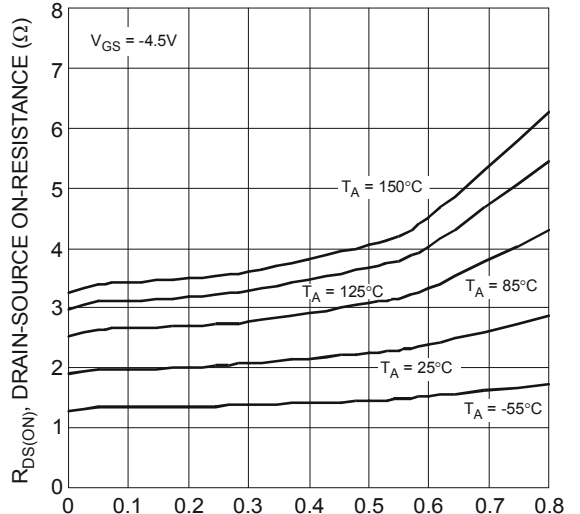

Figure 4 Typical On-Resistance vs. Drain Current and Temperature

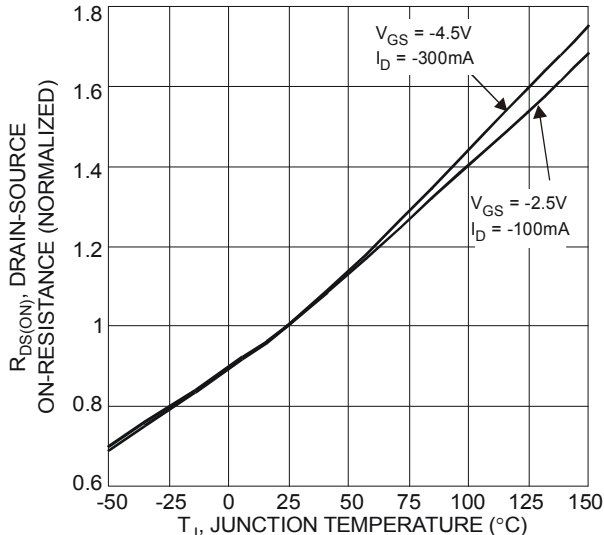

Figure 5 On-Resistance Variation with Temperature

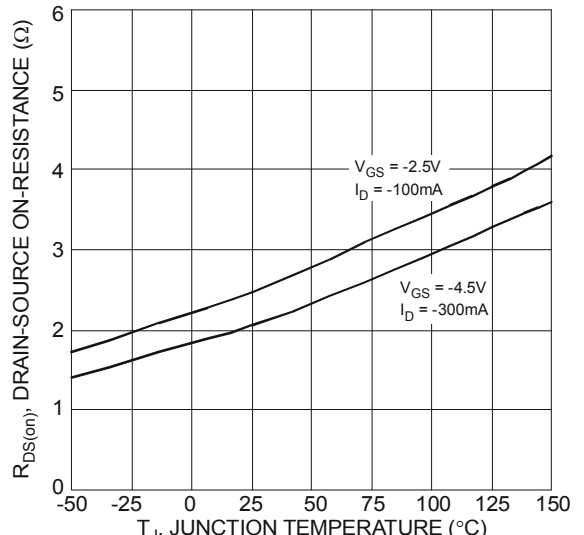

Figure 6 On-Resistance Variation with Temperature

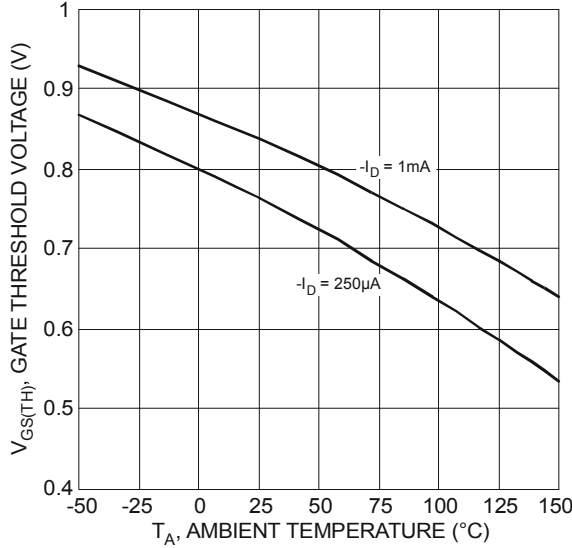

Figure 7 Gate Threshold Variation vs. Ambient Temperature

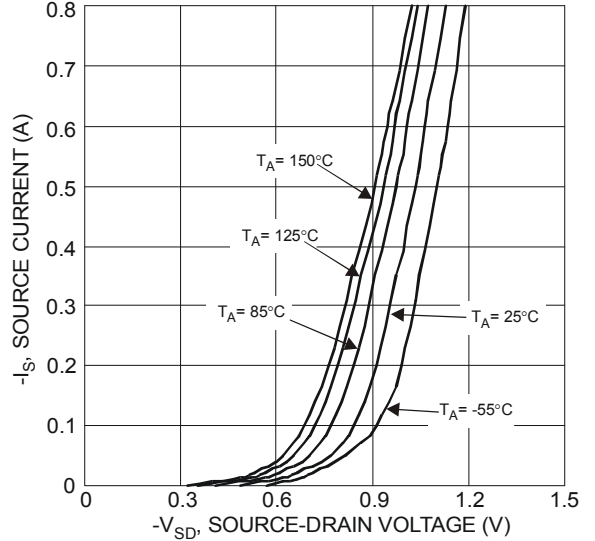

Figure 8 Diode Forward Voltage vs. Current

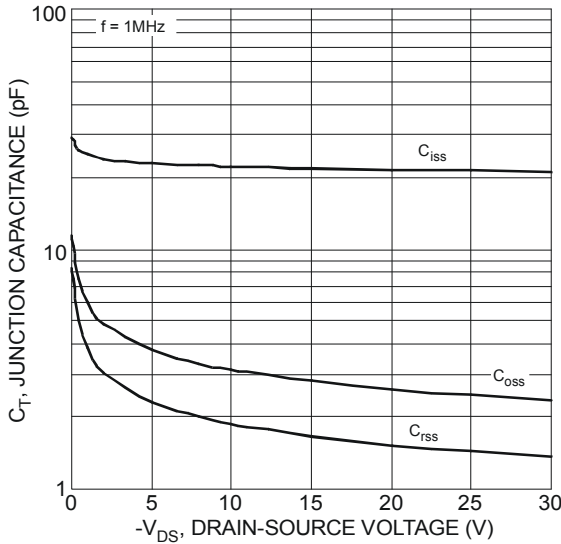

Figure 9 Typical Junction Capacitance

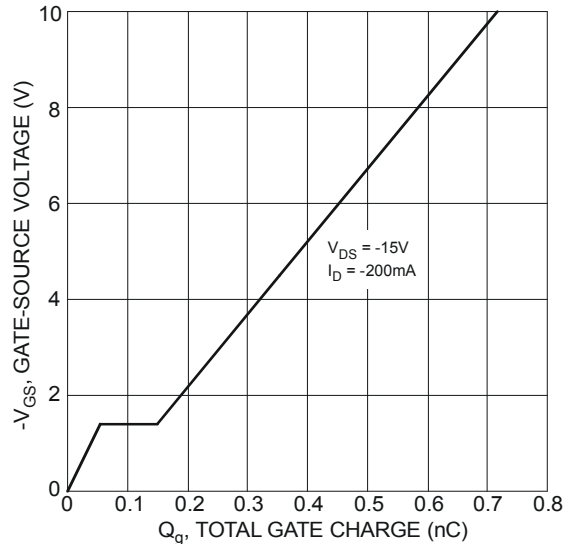

Figure 10 Gate-Charge Characteristics

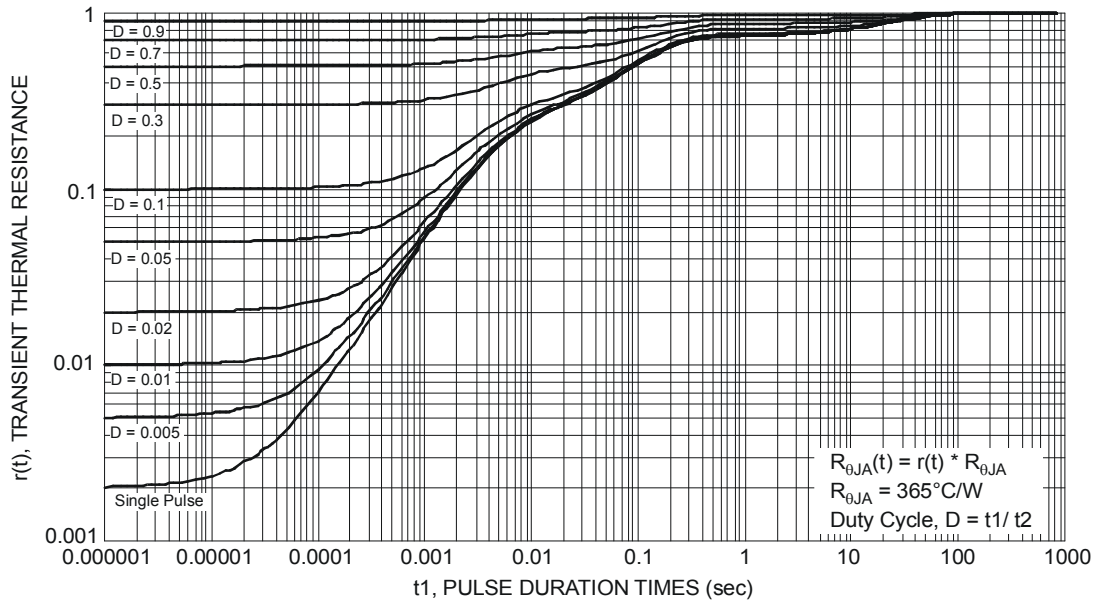
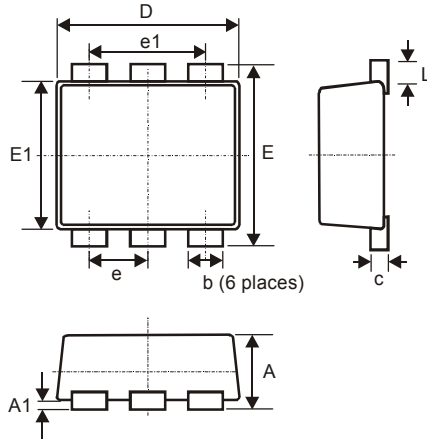

Figure 11 Transient Thermal Resistance

Package Outline Dimensions

Please see AP02002 at <http://www.diodes.com/datasheets/ap02002.pdf> for the latest version.



SOT963			
Dim	Min	Max	Typ
A	0.40	0.50	0.45
A1	0	0.05	-
c	0.120	0.180	0.150
D	0.95	1.05	1.00
E	0.95	1.05	1.00
E1	0.75	0.85	0.80
L	0.05	0.15	0.10
b	0.10	0.20	0.15
e	0.35 Typ		
e1	0.70 Typ		
All Dimensions in mm			

Suggested Pad Layout

Please see AP02001 at <http://www.diodes.com/datasheets/ap02001.pdf> for the latest version.

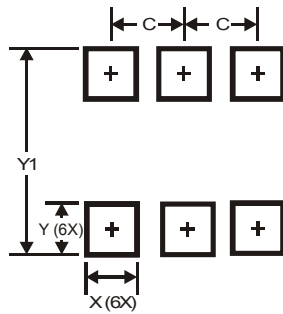

Dimensions	Value (in mm)
C	0.350
X	0.200
Y	0.200
Y1	1.100

NEW PRODUCT

IMPORTANT NOTICE

DIODES INCORPORATED MAKES NO WARRANTY OF ANY KIND, EXPRESS OR IMPLIED, WITH REGARDS TO THIS DOCUMENT, INCLUDING, BUT NOT LIMITED TO, THE IMPLIED WARRANTIES OF MERCHANTABILITY AND FITNESS FOR A PARTICULAR PURPOSE (AND THEIR EQUIVALENTS UNDER THE LAWS OF ANY JURISDICTION).

Diodes Incorporated and its subsidiaries reserve the right to make modifications, enhancements, improvements, corrections or other changes without further notice to this document and any product described herein. Diodes Incorporated does not assume any liability arising out of the application or use of this document or any product described herein; neither does Diodes Incorporated convey any license under its patent or trademark rights, nor the rights of others. Any Customer or user of this document or products described herein in such applications shall assume all risks of such use and will agree to hold Diodes Incorporated and all the companies whose products are represented on Diodes Incorporated website, harmless against all damages.

Diodes Incorporated does not warrant or accept any liability whatsoever in respect of any products purchased through unauthorized sales channel. Should Customers purchase or use Diodes Incorporated products for any unintended or unauthorized application, Customers shall indemnify and hold Diodes Incorporated and its representatives harmless against all claims, damages, expenses, and attorney fees arising out of, directly or indirectly, any claim of personal injury or death associated with such unintended or unauthorized application.

Products described herein may be covered by one or more United States, international or foreign patents pending. Product names and markings noted herein may also be covered by one or more United States, international or foreign trademarks.

This document is written in English but may be translated into multiple languages for reference. Only the English version of this document is the final and determinative format released by Diodes Incorporated.

LIFE SUPPORT

Diodes Incorporated products are specifically not authorized for use as critical components in life support devices or systems without the express written approval of the Chief Executive Officer of Diodes Incorporated. As used herein:

A. Life support devices or systems are devices or systems which:

1. are intended to implant into the body, or
2. support or sustain life and whose failure to perform when properly used in accordance with instructions for use provided in the labeling can be reasonably expected to result in significant injury to the user.

B. A critical component is any component in a life support device or system whose failure to perform can be reasonably expected to cause the failure of the life support device or to affect its safety or effectiveness.

Customers represent that they have all necessary expertise in the safety and regulatory ramifications of their life support devices or systems, and acknowledge and agree that they are solely responsible for all legal, regulatory and safety-related requirements concerning their products and any use of Diodes Incorporated products in such safety-critical, life support devices or systems, notwithstanding any devices- or systems-related information or support that may be provided by Diodes Incorporated. Further, Customers must fully indemnify Diodes Incorporated and its representatives against any damages arising out of the use of Diodes Incorporated products in such safety-critical, life support devices or systems.

Copyright © 2014, Diodes Incorporated

www.diodes.com