

NOTES:

1. MATERIALS AND FINISHES:

- BODY - BRASS, GOLD PLATING
- CONTACT - BeCu, GOLD PLATING
- INSULATOR - PTFE

2. ELECTRICAL:

- A. IMPEDANCE: 50 OHM
- B. FREQUENCY RANGE: 0-26.5 GHz
- C. VSWR: 1.05+0.02 f (GHz) MAX. @ 0-18 GHz
1.5 MAX. @ 18-26.5 GHz
- C. D.W.V: 500 VRMS.
- D. INSULATION RESISTANCE: 1000 MΩ MIN.
- E. CONTACT RESISTANCE:
 - CENTER CONATCT - INITIAL 3.0 MΩ MAX.
AFTER ENVIRONMENTAL 4.0 MΩ MAX.
 - OUTER CONATCT - INITIAL 2.0 MΩ MAX.
AFTER ENVIRONMENTAL NOT APPLICABLE

3. MECHANICAL:

- A. DURABILITY: 500 CYCLES MIN.
- B. TEMPERATURE RANGE: -65°C TO +165°C
- C. ENGAGE/DISENGAGE TORQUE: 2 INCH-LBS MIN.
- D. MATING TORQUE: 7-10 IN-LBS WHEN BODY SUPPORTED WITH WRENCH
8 IN-LBS MAX. UNSUPPORTED
- E. CONTACT RETENTION: 4 LBS MIN. AXIAL FORCE ON PCB END
4 IN-OZ MIN. RADIAL TORQUE

4. PACKAGING:

- A. QUANTITY: SINGLE PACK
- B. MARKING: BAG TO BE MARKED
"AMPHENOLRF, 901-10511-1, AND DATE CODE"

THIRD ANGLE PROJ.

REVISIONS

REV	DESCRIPTION	DATE	ECO	APPR
A	RELEASE TO MFG.	11-Jul-16	01361	KCE

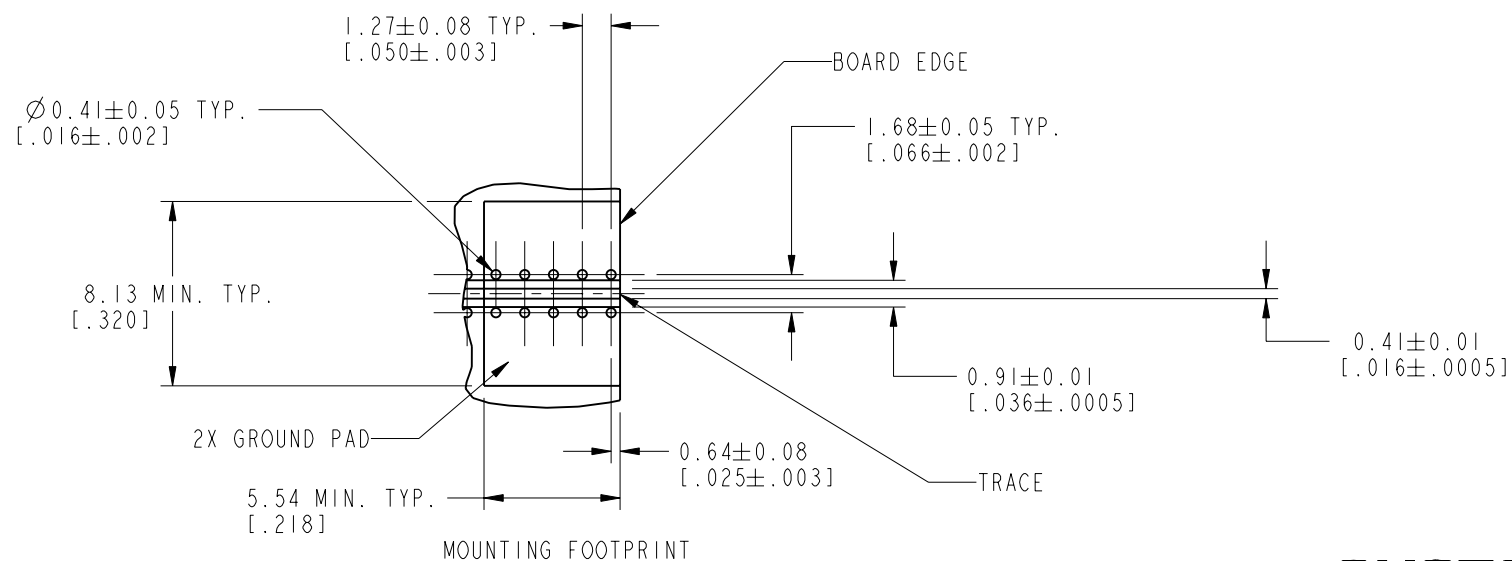
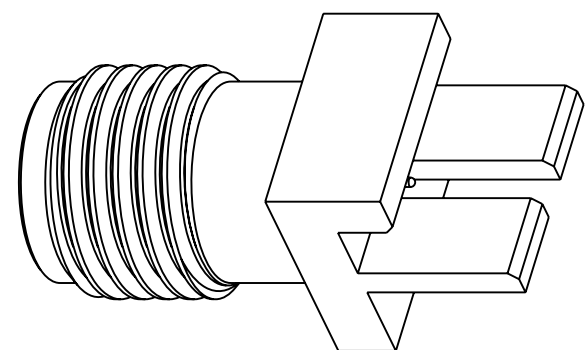
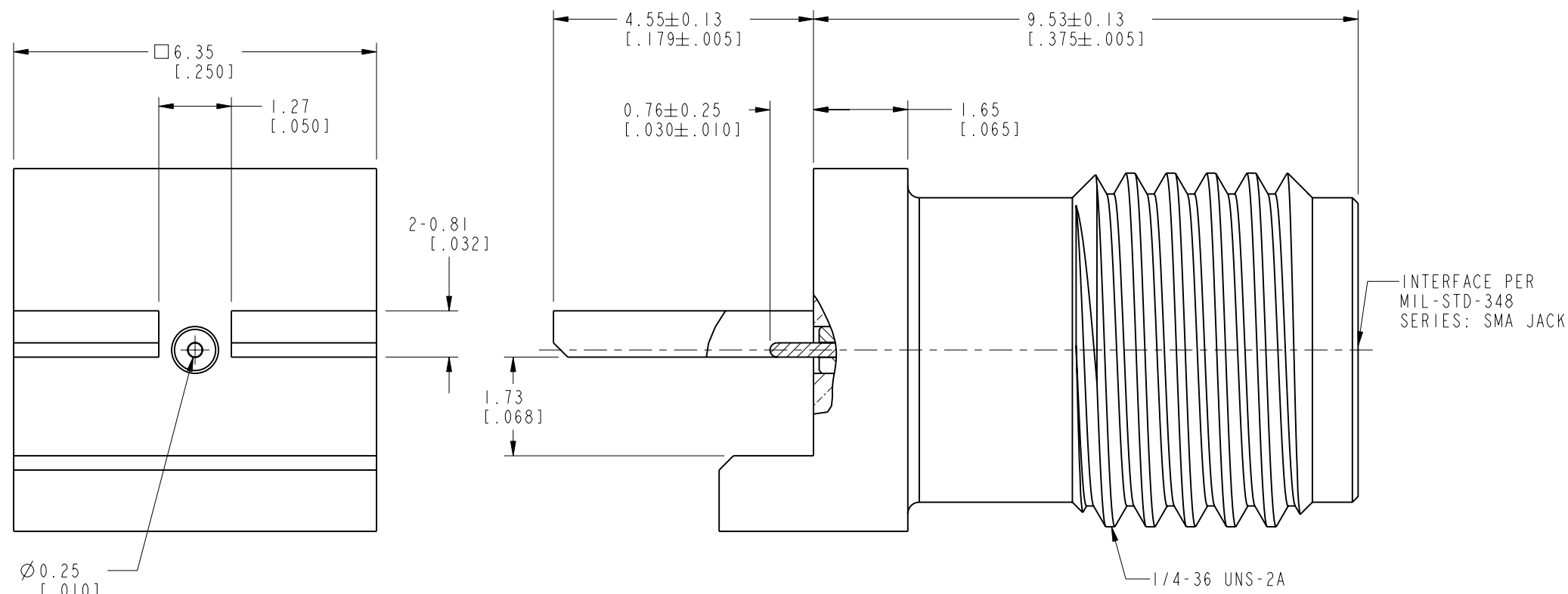

CUSTOMER OUTLINE DRAWING
ALL OTHER SHEETS ARE FOR INTERNAL USE ONLY

UNLESS OTHERWISE SPECIFIED, DIMENSIONS ARE IN METRIC AND TOLERANCES ARE:
 <0.5mm ±0.05mm 0.5 - 6mm ±0.1mm 6 - 30mm ±0.2mm 30 - 120mm ±0.3mm ANGLES ±1°

NOTICE - These drawings, specifications, or other data (1) are, and remain the property of Amphenol corp. (2) must be returned upon request; and (3) are confidential and not to be disclosed to any person other than those to whom they are given by Amphenol Corp. the furnishing of these drawings, specifications, or other data by Amphenol Corp., or to any other person to anyone for any purpose is not to be regarded by implication or otherwise in any manner licensing, granting rights to permitting such holder or any other person to manufacture, use or sell any product, process or design, patented or otherwise, that may in any way be related to or disclosed by said drawings, specifications, or other data.

MATERIAL SEE NOTES
REFERENCE EAR# 6471
CONFIGURATION LEVEL: In Work
FINISH

DRAWN M. ZHANG	DATE 11-Jul-16
ENGINEER K. ELMES	DATE 2/10/16
APPROVED S. HSIEH	DATE 11-Jul-16
CAD FILE	

TITLE HIGH FREQ END LAUNCH SMA JACK ASSEMBLY, PC MOUNT, 10 MIL PIN	
SCALE: 8.0:1.0	SHEET 2 OF 2
DWG SIZE B	REV A

Amphenol RF www.amphenolrf.com	
DRAWING NO. 901-10511-1	
ITEM NO. 901-10511-1	
PART NO. 901-10511-1	