



TXE-315-KH
TXE-418-KH
TXE-433-KH



KH SERIES TRANSMITTER / ENCODER DATA GUIDE

DESCRIPTION

The KH Series is ideally suited for volume use in OEM applications such as remote control and command, and keyless entry. Housed in a compact SMD package, it combines a highly-optimized RF transmitter with an on-board encoder. When paired with a matching KH Series receiver / decoder module, a reliable wireless link is formed, capable of transferring the status of 8 parallel inputs over distances in excess of 300 feet. Ten tri-state address lines provide 59,049 (3^{10}) addresses for security and uniqueness. No external RF components are required (except an antenna), making integration straightforward.

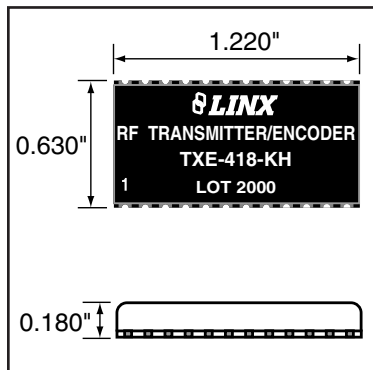

Figure 1: Package Dimensions

FEATURES

- Low cost
- On-board encoder
- 8 parallel binary inputs
- 3^{10} addresses for security and uniqueness
- No external RF components required
- Ultra-low power consumption
- Compact SMD package
- Stable SAW-based architecture
- Adjustable output power
- Transmit enable line
- No production tuning

APPLICATIONS INCLUDE

- Remote Control / Command
- Keyless Entry
- Garage / Gate Openers
- Lighting Control
- Call Systems
- Home / Industrial Automation
- Fire / Security Alarms
- Remote Status Monitoring
- Wire Elimination

ORDERING INFORMATION

PART #	DESCRIPTION
TXE-315-KH	Transmitter 315MHz
TXE-418-KH	Transmitter 418MHz
TXE-433-KH	Transmitter 433MHz
RXD-315-KH	Receiver 315MHz
RXD-418-KH	Receiver 418MHz
RXD-433-KH	Receiver 433MHz
EVAL-***-KH	Basic Evaluation Kit
*** = 315, 418 (Standard), 433.92MHz.	
Transmitters are supplied in tubes of 20 pcs.	

ELECTRICAL SPECIFICATIONS

Parameter	Designation	Min.	Typical	Max.	Units	Notes
POWER SUPPLY						
Operating Voltage	V_{CC}	2.7	–	5.2	VDC	–
Supply Current	I_{CC}	–	1.5	–	mA	1,4
Power-Down Current	I_{PDN}	–	1.0	–	μ A	–
TRANSMITTER SECTION						
Transmit Frequency Range:	F_C					
TXE-315-KH		–	315	–	MHz	–
TXE-418-KH		–	418	–	MHz	–
TXE-433-KH		–	433.92	–	MHz	–
Center Frequency Accuracy	–	-75	–	+75	kHz	–
Output Power	P_O	-4	+2	+4	dBm	2,3
Harmonic Emissions:	P_H					
TXE-315-KH		-40	–	–	dBc	–
TXE-418-KH		-40	–	–	dBc	–
TXE-433-KH		-45	–	–	dBc	–
ANTENNA PORT						
RF Output Impedance	R_{OUT}	–	50	–	Ω	4
ENCODER SECTION						
Data Length	–	–	26 bits 3x	–	–	–
Average Data Duty Cycle	–	–	50%	–	–	4
Encoder Oscillator	F_{ENC}	–	70	–	kHz	4
Data Input:						
Logic Low	–	0.0	–	$0.2 \times V_{CC}$	VDC	4
Logic High	–	$V_{CC} \times 0.8$	–	V_{CC}	VDC	4
Input Sink Current	–	0.6	1.0	1.2	mA	4
ENVIRONMENTAL						
Operating Temperature Range	–	-30	–	+70	$^{\circ}$ C	4

Table 1: KH Series Transmitter Electrical Specifications

Notes

1. Current draw with 50% mark / space ratio.
2. Into a 50 Ω load.
3. With 430 Ω resistor on LADJ.
4. Characterized, but not tested.

CAUTION

This product incorporates numerous static-sensitive components. Always wear an ESD wrist strap and observe proper ESD handling procedures when working with this device. Failure to observe this precaution may result in module damage or failure.

ABSOLUTE MAXIMUM RATINGS

Supply Voltage V_{CC}	-0.3	to	+6.0	VDC
Any Input or Output Pin	-0.3	to	V_{CC}	VDC
Operating Temperature	-30	to	+70	$^{\circ}$ C
Storage Temperature	-45	to	+85	$^{\circ}$ C
Soldering Temperature	+225 $^{\circ}$ C for 10 seconds			

NOTE Exceeding any of the limits of this section may lead to permanent damage to the device. Furthermore, extended operation at these maximum ratings may reduce the life of this device.

PERFORMANCE DATA

These performance parameters are based on module operation at 25 $^{\circ}$ C from a 3.0VDC supply unless otherwise noted. Figure 2 illustrates the connections necessary for testing and operation. It is recommended all ground pins be connected to the ground plane.

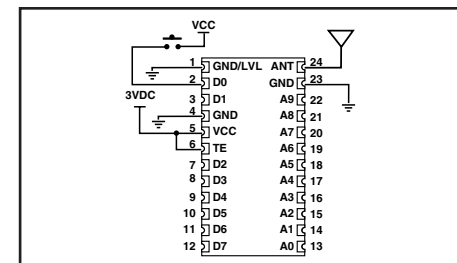

Figure 2: Test / Basic Application Circuit

TYPICAL PERFORMANCE GRAPHS

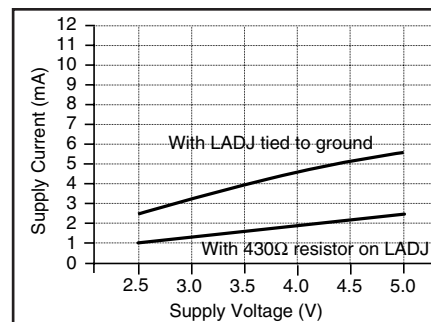

Figure 3: Supply Current vs. Supply Voltage

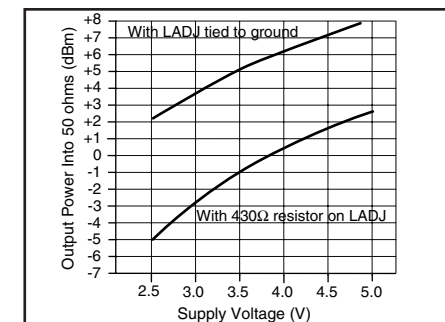

Figure 4: Output Power vs. Supply Voltage

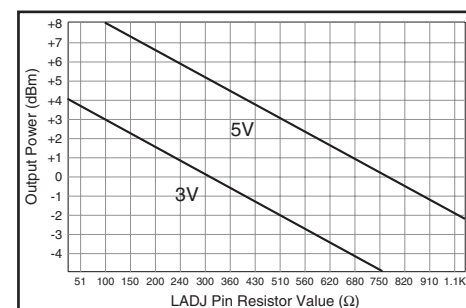

Figure 5: Output Power vs. LADJ Resistor

PIN ASSIGNMENTS

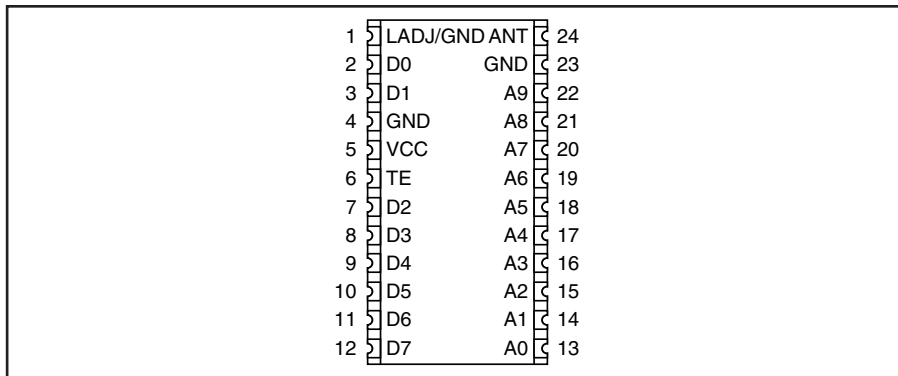

Figure 6: KH Series Transmitter Pinout (Top View)

PIN DESCRIPTIONS

Pin #	Name	Description
1	GND / LADJ	Level Adjust. This line can be used to adjust the output power level of the transmitter. Connecting to GND will give the highest output, while placing a resistor to GND will lower the output level.
2, 3, 7-12	D0 - D1	Data Input Lines. When TE goes high, the module will encode the state of these lines for transmission. Upon receipt of a valid transmission, the receiver / decoder will replicate these lines on its output lines.
4	GND	Analog Ground
5	V _{CC}	Supply Voltage
6	TE	Transmit Enable Line. When this line goes high, the module will encode the states of the address and data lines into a packet and transmit the packet three times.
13-22	A0-A9	Address Lines. The state of these lines must match the state of the receiver's address lines in order for a transmission to be accepted.
23	GND	Analog Ground
24	ANT	50-ohm RF Output

MODULE DESCRIPTION

The KH Series transmitter / encoder module combines a high-performance Surface Acoustic Wave (SAW) based transmitter with an on-board encoder. When combined with a Linx KH Series receiver / decoder, a highly reliable RF link capable of transferring control or command data over line-of-sight distances in excess of 300 feet is formed. The module accepts up to 8 parallel inputs, such as switches or contact closures, and provides ten tri-state address lines for security and creation of 59,049 (310) unique transmitter / receiver relationships. The KH's compact surface-mount package integrates easily into existing designs and is friendly to hand production or automated assembly.

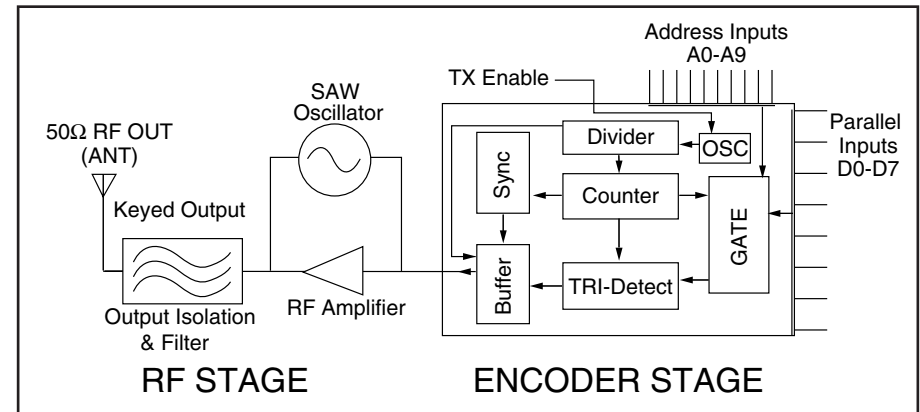

Figure 7: KH Series Transmitter Block Diagram

THEORY OF OPERATION

The KH Series transmitter operation is straightforward. When the Transmit Enable (TE) line is taken high, the on-board encoder IC is activated. The encoder detects the logic states of the data and address lines. These states are formatted into a 3-word transmission, which continues until the TE line is taken low. The encoder creates a serial data packet that is used to modulate the transmitter.

The transmitter section is based on a simple, but highly-optimized, architecture that achieves a high fundamental output power with low harmonic content. This ensures that most approval standards can be met without external filter components. The KH Series transmitter is exceptionally stable over variations in time, temperature, and physical shock as a result of the precision SAW device that is incorporated as the frequency reference.

The transmitted signal may be received by any Linx KH Series receiver / decoder module or Linx LC or LR Series receiver combined with the appropriate decoder IC. Once data is received, it is decoded using a decoder IC or custom microcontroller. The transmitted address bits are checked against the address settings of the receiving device. If a match is confirmed, the decoder's outputs are set to replicate the transmitter's inputs.

ENCODER OPERATION

The KH Series transmitter internally utilizes the HT640 encoder from Holtek. The encoder begins a three-word transmission cycle when the Transmission Enable line (TE) is pulled high. This cycle will repeat itself for as long as the TE line is held high. Once TE falls low, the encoder output completes its final cycle and then stops as shown in the Encoder / Decoder Timing diagram. When a transmission enable signal is applied, the encoder scans and transmits the status of the 10 bits of the address code and the 8 bits of the data serially in the order A0 to A9, D0 to D7.

The status of each address / data pin can be individually preset to logic high, low, or floating. The floating state on the data input is interpreted as logic low by the decoders since the decoder output only has two states. The address pins are usually set to transmit particular security codes by DIP switches or PCB wiring, while the data is selected using push buttons or electronic switches. The floating state allows the KH transmitter to be used without pull-up or pull-down resistors on the data and address input lines.

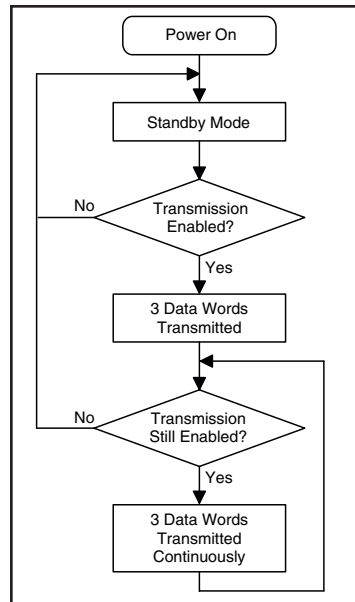

Figure 8: Encoder Flowchart

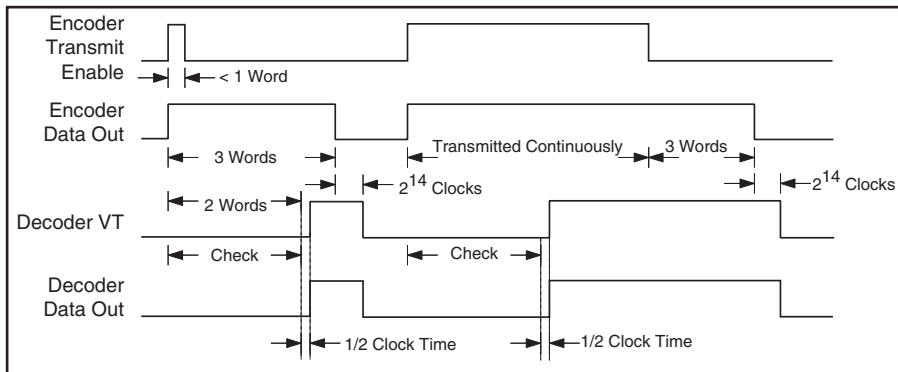

Figure 9: Encoder / Decoder Timing Diagram

SETTING THE TRANSMITTER ADDRESS

The module provides ten tri-state address lines. This allows for the formation of up to 59,049 (3^{10}) unique transmitter-receiver relationships. Tri-state means that the address lines have three distinct states: high, low, or floating. These pins may be hardwired or configured via a microprocessor, DIP switch, or jumpers. The receiver's address line states must match the transmitter's exactly for a transmission to be recognized. If the transmitted address does not match the receiver's local address, then the receiver will take no action.

POWER SUPPLY REQUIREMENTS

The module does not have an internal voltage regulator; therefore it requires a clean, well-regulated power source. While it is preferable to power the unit from a battery, it can also be operated from a power supply as long as noise is less than 20mV. Power supply noise can affect the transmitter modulation; therefore, providing a clean power supply for the module should be a high priority during design.

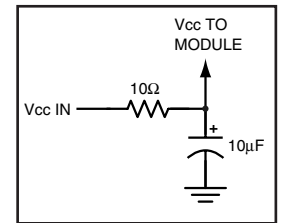

Figure 10: Supply Filter

A 10 Ω resistor in series with the supply followed by a 10 μ F tantalum capacitor from V_{CC} to ground will help in cases where the quality of supply power is poor. These values may need to be adjusted depending on the noise present on the supply line.

DATA INPUTS

When the Transmit Enable (TE) line goes high, the states of the eight data input lines are recorded and encoded for transmission. The data lines are tri-state, which means that they can be high, low, or floating, though the decoder will interpret the floating state as a low. This feature means that the data lines do not require pull-up or pull-down resistors. The states of the data lines can be set by switches, jumpers, microcontrollers, or hardwired on the PCB.

The encoder will send the states of the address and data lines three times. If the TE line is still high, it will begin the cycle again. This means that the states of the data lines are refreshed with each cycle, so the data lines can be changed without having to pull TE low. There can be up to a 150mS lag in response as the transmitter finishes one cycle then refreshes and starts over.

ENABLING TRANSMISSION

The module's Transmit Enable (TE) line controls transmission status. When taken high, the module initiates transmission, which continues until the line is pulled low or power to the module is removed. In some cases this line will be wired permanently to V_{CC} and transmission controlled by switching V_{CC} to the module. This is particularly useful in applications where the module powers up and sends a transmission only when a button is pressed on the remote.

USING LADJ

The LADJ line allows the transmitter's output power to be easily adjusted for range control, lower power consumption, or to meet legal requirements. This is done by placing a resistor between GND and LADJ. When LADJ is connected directly to GND, the output power will be at its maximum. Placing a resistor will lower the output power by up to 7dB, as shown on Page 3 of this data guide.

This is very useful during FCC testing to compensate for antenna gain or other product-specific issues that may cause the output power to exceed legal limits. A variable resistor can be used so that the test lab can precisely adjust the output power to the maximum level allowed by law. The resistor's value can be noted and a fixed resistor substituted for final testing. Even in designs where attenuation is not anticipated, it is a good idea to place a resistor pad connected to LADJ and GND so that it can be used if needed.

PROTOCOL GUIDELINES

While many RF solutions impose data formatting and balancing requirements, Linx RF modules do not encode or packetize the signal content in any manner. The received signal will be affected by such factors as noise, edge jitter, and interference, but it is not purposefully manipulated or altered by the modules. This gives the designer tremendous flexibility for protocol design and interface.

Despite this transparency and ease of use, it must be recognized that there are distinct differences between a wired and a wireless environment. Issues such as interference and contention must be understood and allowed for in the design process. To learn more about protocol considerations, we suggest you read Linx Application Note AN-00160.

Errors from interference or changing signal conditions can cause corruption of the data packet, so it is generally wise to structure the data being sent into small packets. This allows errors to be managed without affecting large amounts of data. A simple checksum or CRC could be used for basic error detection. Once an error is detected, the protocol designer may wish to simply discard the corrupt data or implement a more sophisticated scheme to correct it.

INTERFERENCE CONSIDERATIONS

The RF spectrum is crowded and the potential for conflict with other unwanted sources of RF is very real. While all RF products are at risk from interference, its effects can be minimized by better understanding its characteristics.

Interference may come from internal or external sources. The first step is to eliminate interference from noise sources on the board. This means paying careful attention to layout, grounding, filtering, and bypassing in order to eliminate all radiated and conducted interference paths. For many products, this is straightforward; however, products containing components such as switching power supplies, motors, crystals, and other potential sources of noise must be approached with care. Comparing your own design with a Linx evaluation board can help to determine if and at what level design-specific interference is present.

External interference can manifest itself in a variety of ways. Low-level interference will produce noise and hashing on the output and reduce the link's overall range.

High-level interference is caused by nearby products sharing the same frequency or from near-band high-power devices. It can even come from your own products if more than one transmitter is active in the same area. It is important to remember that only one transmitter at a time can occupy a frequency, regardless of the coding of the transmitted signal. This type of interference is less common than those mentioned previously, but in severe cases it can prevent all useful function of the affected device.

Although technically it is not interference, multipath is also a factor to be understood. Multipath is a term used to refer to the signal cancellation effects that occur when RF waves arrive at the receiver in different phase relationships. This effect is a particularly significant factor in interior environments where objects provide many different signal reflection paths. Multipath cancellation results in lowered signal levels at the receiver and, thus, shorter useful distances for the link.

TYPICAL APPLICATIONS

Below is an example of a basic remote control transmitter utilizing the KH Series transmitter. When a key is pressed on the transmitter, a corresponding line on the receiver goes high. A schematic for the receiver / decoder circuit may be found in the KH Series Receiver Data Guide. These circuits are implemented in the KH Series Basic Evaluation kit. They can be easily modified for custom applications and clearly demonstrate the ease of using the KH Series modules for remote control applications.

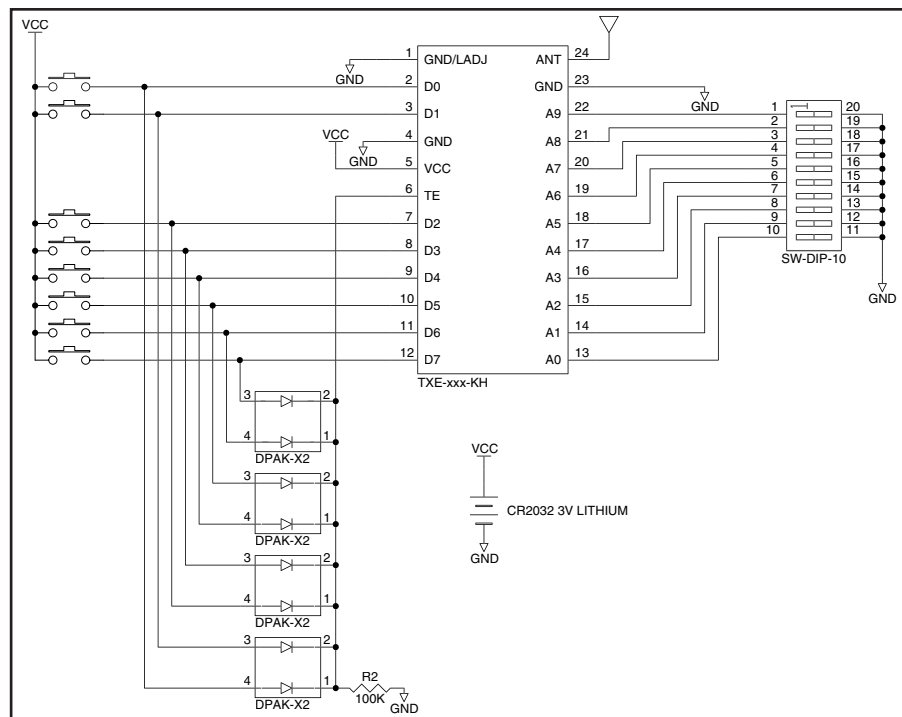

Figure 11: Basic Remote Control Transmitter

The ten-position DIP switch is used to set the address to either ground or floating. Since the floating state is a valid state, no pull-up resistors are needed.

The data lines are pulled high by momentary pushbuttons. Since the floating state is interpreted as a low by the decoder, no pull-down resistors are needed.

Diodes are used to pull the TE line high when any data line goes high, while isolating the data lines from each other. This will make the transmitter send data when any button is pressed without affecting any of the other data lines.

The KH Series transmitter / encoder module is also suitable for use with the Linx OEM function receivers. These receivers are FCC certified, making product introduction extremely quick. Information on these products can be found on the Linx website at www.linxtechnologies.com.

BOARD LAYOUT GUIDELINES

If you are at all familiar with RF devices, you may be concerned about specialized board layout requirements. Fortunately, because of the care taken by Linx in designing the modules, integrating them is very straightforward. Despite this ease of application, it is still necessary to maintain respect for the RF stage and exercise appropriate care in layout and application in order to maximize performance and ensure reliable operation. The antenna can also be influenced by layout choices. Please review this data guide in its entirety prior to beginning your design. By adhering to good layout principles and observing some basic design rules, you will be on the path to RF success.

The adjacent figure shows the suggested PCB footprint for the module. The actual pad dimensions are shown in the Pad Layout section of this manual. A ground plane (as large as possible) should be placed on a lower layer of your PC board opposite the module. This ground plane can also be critical to the performance of your antenna, which will be discussed later. There should not be any ground or traces under the module on the same layer as the module, just bare PCB.

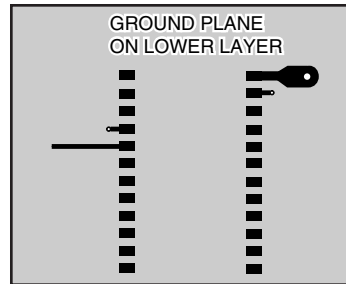

Figure 12: Suggested PCB Layout

During prototyping, the module should be soldered to a properly laid-out circuit board. The use of prototyping or “perf” boards will result in horrible performance and is strongly discouraged.

No conductive items should be placed within 0.15in of the module’s top or sides.

Do not route PCB traces directly under the module. The underside of the module has numerous signal-bearing traces and vias that could short or couple to traces on the product’s circuit board.

The module’s ground lines should each have their own via to the ground plane and be as short as possible.

AM / OOK receivers are particularly subject to noise. The module should, as much as reasonably possible, be isolated from other components on your PCB, especially high-frequency circuitry such as crystal oscillators, switching power supplies, and high-speed bus lines. Make sure internal wiring is routed away from the module and antenna, and is secured to prevent displacement.

The power supply filter should be placed close to the module’s V_{CC} line.

In some instances, a designer may wish to encapsulate or “pot” the product. Many Linx customers have done this successfully; however, there are a wide variety of potting compounds with varying dielectric properties. Since such compounds can considerably impact RF performance, it is the responsibility of the designer to carefully evaluate and qualify the impact and suitability of such materials.

The trace from the module to the antenna should be kept as short as possible. A simple trace is suitable for runs up to 1/8-inch for antennas with wide bandwidth characteristics. For longer runs or to avoid detuning narrow bandwidth antennas, such as a helical, use a 50-ohm coax or 50-ohm microstrip transmission line as described in the following section.

MICROSTRIP DETAILS

A transmission line is a medium whereby RF energy is transferred from one place to another with minimal loss. This is a critical factor, especially in high-frequency products like Linx RF modules, because the trace leading to the module’s antenna can effectively contribute to the length of the antenna, changing its resonant bandwidth. In order to minimize loss and detuning, some form of transmission line between the antenna and the module should be used, unless the antenna can be placed very close (<1/8in.) to the module. One common form of transmission line is a coax cable, another is the microstrip. This term refers to a PCB trace running over a ground plane that is designed to serve as a transmission line between the module and the antenna. The width is based on the desired characteristic impedance of the line, the thickness of the PCB, and the dielectric constant of the board material. For standard 0.062in thick FR-4 board material, the trace width would be 111 mils. The correct trace width can be calculated for other widths and materials using the information below. Handy software for calculating microstrip lines is also available on the Linx website, www.linxtechnologies.com.

$$E_e = \frac{E_r + 1}{2} + \frac{E_r - 1}{2} \cdot \frac{1}{\sqrt{1 + 12d/W}}$$

$$Z_0 = \begin{cases} \frac{60}{\sqrt{E_e}} \cdot \ln\left(\frac{8d}{W} + \frac{W}{4d}\right) & \text{For } \frac{W}{d} \leq 1 \\ \frac{120\pi}{\sqrt{E_e} \cdot \left(\frac{W}{d} + 1.393 + 0.667 \cdot \ln\left(\frac{W}{d} + 1.444\right)\right)} & \text{For } \frac{W}{d} \geq 1 \end{cases}$$

E_r = Dielectric constant of PCB material

Figure 13: Microstrip Formulas

Dielectric Constant	Width/Height (W/d)	Effective Dielectric Constant	Characteristic Impedance
4.80	1.8	3.59	50.0
4.00	2.0	3.07	51.0
2.55	3.0	2.12	48.0

PAD LAYOUT

The following pad layout diagram is designed to facilitate both hand and automated assembly.

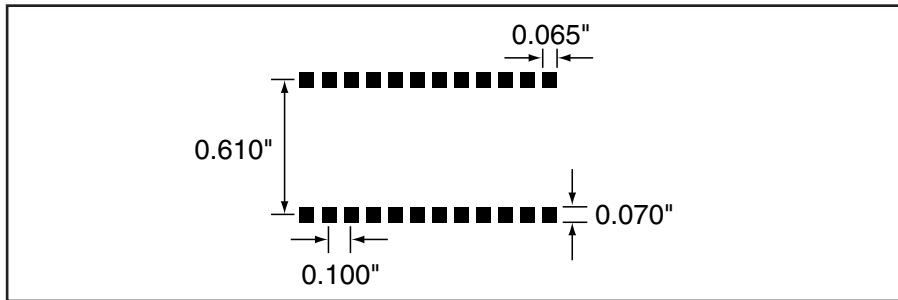

Figure 14: Recommended PCB Layout

PRODUCTION GUIDELINES

The modules are housed in a hybrid SMD package that supports hand or automated assembly techniques. Since the modules contain discrete components internally, the assembly procedures are critical to ensuring the reliable function of the modules. The following procedures should be reviewed with and practiced by all assembly personnel.

HAND ASSEMBLY

Pads located on the bottom of the module are the primary mounting surface. Since these pads are inaccessible during mounting, castellations that run up the side of the module have been provided to facilitate solder wicking to the module's underside. This allows for very quick hand soldering for prototyping and small volume production.

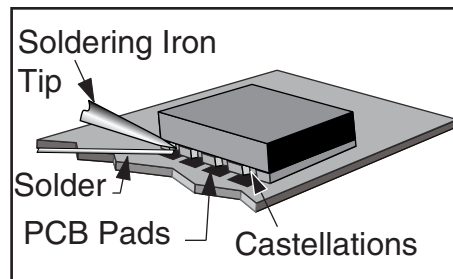

Figure 15: Soldering Technique

If the recommended pad guidelines have been followed, the pads will protrude slightly past the edge of the module. Use a fine soldering tip to heat the board pad and the castellation, then introduce solder to the pad at the module's edge. The solder will wick underneath the module, providing reliable attachment. Tack one module corner first and then work around the device, taking care not to exceed the times listed below.

Absolute Maximum Solder Times

Hand-Solder Temp. TX +225°C for 10 Seconds

Hand-Solder Temp. RX +225°C for 10 Seconds

Recommended Solder Melting Point +180°C

Reflow Oven: +220°C Max. (See adjoining diagram)

AUTOMATED ASSEMBLY

For high-volume assembly, most users will want to auto-place the modules. The modules have been designed to maintain compatibility with reflow processing techniques; however, due to their hybrid nature, certain aspects of the assembly process are far more critical than for other component types.

Following are brief discussions of the three primary areas where caution must be observed.

Reflow Temperature Profile

The single most critical stage in the automated assembly process is the reflow stage. The reflow profile below should not be exceeded, since excessive temperatures or transport times during reflow will irreparably damage the modules. Assembly personnel will need to pay careful attention to the oven's profile to ensure that it meets the requirements necessary to successfully reflow all components while still remaining within the limits mandated by the modules. The figure below shows the recommended reflow oven profile for the modules.

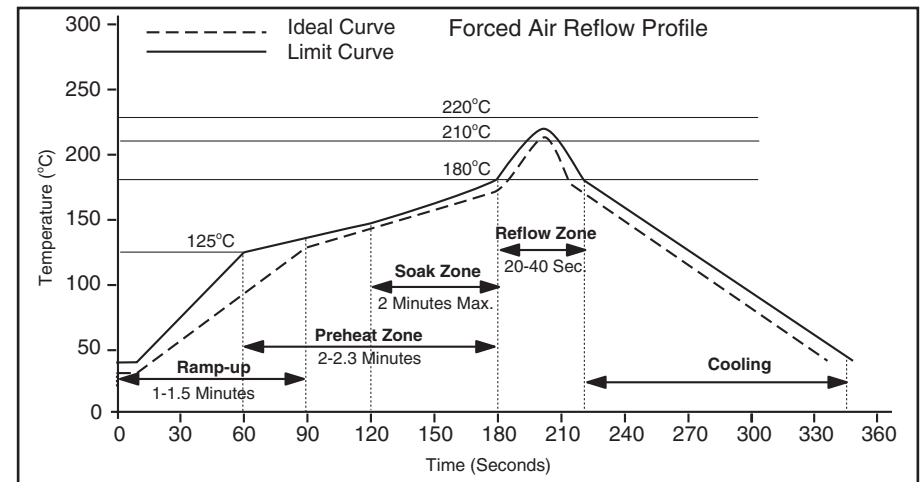

Figure 16: Maximum Reflow Profile

Shock During Reflow Transport

Since some internal module components may reflow along with the components placed on the board being assembled, it is imperative that the modules not be subjected to shock or vibration during the time solder is liquid. Should a shock be applied, some internal components could be lifted from their pads, causing the module to not function properly.

Washability

The modules are wash resistant, but are not hermetically sealed. Linx recommends wash-free manufacturing; however, the modules can be subjected to a wash cycle provided that a drying time is allowed prior to applying electrical power to the modules. The drying time should be sufficient to allow any moisture that may have migrated into the module to evaporate, thus eliminating the potential for shorting damage during power-up or testing. If the wash contains contaminants, the performance may be adversely affected, even after drying.

ANTENNA CONSIDERATIONS

The choice of antennas is a critical and often overlooked design consideration. The range, performance, and legality of an RF link are critically dependent upon the antenna. While adequate antenna performance can often be obtained by trial and error methods, antenna design and matching is a complex task. A professionally designed antenna, such as those from Linx, will help ensure maximum performance and FCC compliance.

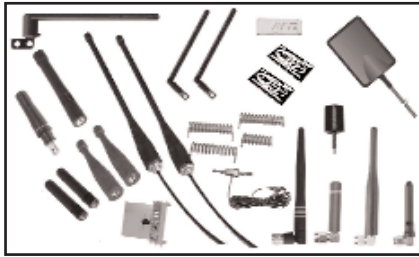

Figure 17: Linx Antennas

Linx transmitter modules typically have an output power that is slightly higher than the legal limits. This allows the designer to use an inefficient antenna, such as a loop trace or helical, to meet size, cost, or cosmetic requirements and still achieve full legal output power for maximum range. If an efficient antenna is used, then some attenuation of the output power will likely be needed. This can easily be accomplished by using the LADJ line or a T-pad attenuator. For more details on T-pad attenuator design, please see Application Note AN-00150.

A receiver antenna should be optimized for the frequency or band in which the receiver operates and to minimize the reception of off-frequency signals. The efficiency of the receiver's antenna is critical to maximizing range performance. Unlike the transmitter antenna, where legal operation may mandate attenuation or a reduction in antenna efficiency, the receiver's antenna should be optimized as much as is practical.

It is usually best to utilize a basic quarter-wave whip until your prototype product is operating satisfactorily. Other antennas can then be evaluated based on the cost, size, and cosmetic requirements of the product. You may wish to review Application Note AN-00500 "Antennas: Design, Application, Performance"

ANTENNA SHARING

In cases where a transmitter and receiver module are combined to form a transceiver, it is often advantageous to share a single antenna. To accomplish this, an antenna switch must be used to provide isolation between the modules so that the full transmitter output power is not put on the sensitive front end of the receiver. There are a wide variety of antenna switches that are cost-effective and easy to use. Among the most popular are switches from Macom and NEC. Look for an antenna switch that has high isolation and low loss at the desired frequency of operation. Generally, the Tx or Rx status of a switch will be controlled by a product's microprocessor, but the user may also make the selection manually. In some cases, where the characteristics of the Tx and Rx antennas need to be different or antenna switch losses are unacceptable, it may be more appropriate to utilize two discrete antennas.

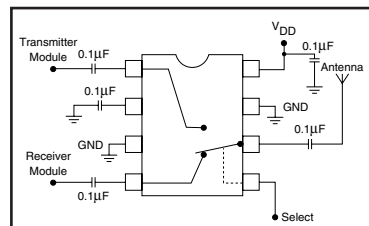

Figure 18: Typical Antenna Switch

GENERAL ANTENNA RULES

The following general rules should help in maximizing antenna performance.

1. Proximity to objects such as a user's hand, body, or metal objects will cause an antenna to detune. For this reason, the antenna shaft and tip should be positioned as far away from such objects as possible.

2. Optimum performance will be obtained from a 1/4- or 1/2-wave straight whip mounted at a right angle to the ground plane. In many cases, this isn't desirable for practical or ergonomic reasons, thus, an alternative antenna style such as a helical, loop, or patch may be utilized

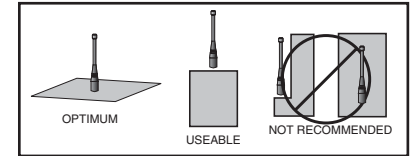

Figure 19: Ground Plane Orientation

3. If an internal antenna is to be used, keep it away from other metal components, particularly large items like transformers, batteries, PCB tracks, and ground planes. In many cases, the space around the antenna is as important as the antenna itself. Objects in close proximity to the antenna can cause direct detuning, while those farther away will alter the antenna's symmetry.

4. In many antenna designs, particularly 1/4-wave whips, the ground plane acts as a counterpoise, forming, in essence, a 1/2-wave dipole. For this reason, adequate ground plane area is essential. The ground plane can be a metal case or ground-fill areas on a circuit board. Ideally, it should have a surface area \geq the overall length of the 1/4-wave radiating element. This is often not practical due to size and configuration constraints. In these instances, a designer must make the best use of the area available to create as much ground plane as possible in proximity to the base of the antenna. In cases where the antenna is remotely located or the antenna is not in close proximity to a circuit board, ground plane, or grounded metal case, a metal plate may be used to maximize the antenna's performance.

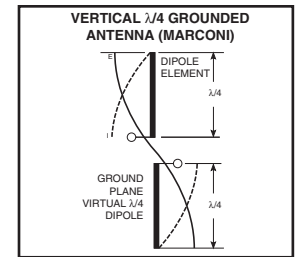

Figure 20: Dipole Antenna

5. Remove the antenna as far as possible from potential interference sources. Any frequency of sufficient amplitude to enter the receiver's front end will reduce system range and can even prevent reception entirely. Switching power supplies, oscillators, or even relays can also be significant sources of potential interference. The single best weapon against such problems is attention to placement and layout. Filter the module's power supply with a high-frequency bypass capacitor. Place adequate ground plane under potential sources of noise to shunt noise to ground and prevent it from coupling to the RF stage. Shield noisy board areas whenever practical.

6. In some applications, it is advantageous to place the module and antenna away from the main equipment. This can avoid interference problems and allows the antenna to be oriented for optimum performance. Always use 50Ω coax, like RG-174, for the remote feed.

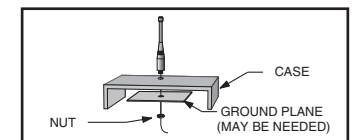

Figure 21: Remote Ground Plane

COMMON ANTENNA STYLES

There are literally hundreds of antenna styles and variations that can be employed with Linx RF modules. Following is a brief discussion of the styles most commonly utilized. Additional antenna information can be found in Linx Application Notes AN-00100, AN-00140, and AN-00500. Linx antennas and connectors offer outstanding performance at a low price.

Whip Style



$$L = \frac{234}{F} \text{ MHz}$$

Where:
L = length in feet of quarter-wave length
F = operating frequency in megahertz

A whip-style antenna provides outstanding overall performance and stability. A low-cost whip is can be easily fabricated from a wire or rod, but most designers opt for the consistent performance and cosmetic appeal of a professionally-made model. To meet this need, Linx offers a wide variety of straight and reduced-height whip-style antennas in permanent and connectorized mounting styles.

The wavelength of the operational frequency determines an antenna's overall length. Since a full wavelength is often quite long, a partial 1/2- or 1/4-wave antenna is normally employed. Its size and natural radiation resistance make it well matched to Linx modules. The proper length for a straight 1/4-wave can be easily determined using the adjacent formula. It is also possible to reduce the overall height of the antenna by using a helical winding. This reduces the antenna's bandwidth, but is a great way to minimize the antenna's physical size for compact applications. This also means that the physical appearance is not always an indicator of the antenna's frequency.

Specialty Styles



Linx offers a wide variety of specialized antenna styles. Many of these styles utilize helical elements to reduce the overall antenna size while maintaining reasonable performance. A helical antenna's bandwidth is often quite narrow and the antenna can detune in proximity to other objects, so care must be exercised in layout and placement.

Loop Style



A loop- or trace-style antenna is normally printed directly on a product's PCB. This makes it the most cost-effective of antenna styles. The element can be made self-resonant or externally resonated with discrete components, but its actual layout is usually product specific. Despite the cost advantages, loop-style antennas are generally inefficient and useful only for short-range applications. They are also very sensitive to changes in layout and PCB dielectric, which can cause consistency issues during production. In addition, printed styles are difficult to engineer, requiring the use of expensive equipment, including a network analyzer. An improperly designed loop will have a high SWR at the desired frequency, which can cause instability in the RF stage.



Linx offers low-cost planar and chip antennas that mount directly to a product's PCB. These tiny antennas do not require testing and provide excellent performance in light of their small size. They offer a preferable alternative to the often-problematic "printed" antenna.

ONLINE RESOURCES



www.linxtechnologies.com

- Latest News
- Data Guides
- Application Notes
- Knowledgebase
- Software Updates



If you have questions regarding any Linx product and have Internet access, make www.linxtechnologies.com your first stop. Our website is organized in an intuitive format to immediately give you the answers you need. Day or night, the Linx website gives you instant access to the latest information regarding the products and services of Linx. It's all here: manual and software updates, application notes, a comprehensive knowledgebase, FCC information, and much more. Be sure to visit often!



www.antennafactor.com

The Antenna Factor division of Linx offers a diverse array of antenna styles, many of which are optimized for use with our RF modules. From innovative embeddable antennas to low-cost whips, domes to Yagis, and even GPS, Antenna Factor likely has an antenna for you, or can design one to meet your requirements.



www.connectorcity.com

Through its Connector City division, Linx offers a wide selection of high-quality RF connectors, including FCC-compliant types such as RP-SMAs that are an ideal match for our modules and antennas. Connector City focuses on high-volume OEM requirements, which allows standard and custom RF connectors to be offered at a remarkably low cost.



LEGAL CONSIDERATIONS

NOTE: Linx RF modules are designed as component devices that require external components to function. The modules are intended to allow for full Part 15 compliance; however, they are not approved by the FCC or any other agency worldwide. The purchaser understands that approvals may be required prior to the sale or operation of the device, and agrees to utilize the component in keeping with all laws governing its use in the country of operation.

When working with RF, a clear distinction must be made between what is technically possible and what is legally acceptable in the country where operation is intended. Many manufacturers have avoided incorporating RF into their products as a result of uncertainty and even fear of the approval and certification process. Here at Linx, our desire is not only to expedite the design process, but also to assist you in achieving a clear idea of what is involved in obtaining the necessary approvals to legally market your completed product.

In the United States, the approval process is actually quite straightforward. The regulations governing RF devices and the enforcement of them are the responsibility of the Federal Communications Commission (FCC). The regulations are contained in Title 47 of the Code of Federal Regulations (CFR). Title 47 is made up of numerous volumes; however, all regulations applicable to this module are contained in Volume 0-19. It is strongly recommended that a copy be obtained from the Government Printing Office in Washington or from your local government bookstore. Excerpts of applicable sections are included with Linx evaluation kits or may be obtained from the Linx Technologies website, www.linxtechnologies.com. In brief, these rules require that any device that intentionally radiates RF energy be approved, that is, tested for compliance and issued a unique identification number. This is a relatively painless process. Linx offers full EMC pre-compliance testing in our HP / Emco-equipped test center. Final compliance testing is then performed by one of the many independent testing laboratories across the country. Many labs can also provide other certifications that the product may require at the same time, such as UL, CLASS A / B, etc. Once your completed product has passed, you will be issued an ID number that is to be clearly placed on each product manufactured.

Questions regarding interpretations of the Part 2 and Part 15 rules or measurement procedures used to test intentional radiators, such as Linx RF modules, for compliance with the technical standards of Part 15, should be addressed to:

Federal Communications Commission
Equipment Authorization Division
Customer Service Branch, MS 1300F2
7435 Oakland Mills Road
Columbia, MD 21046

Phone: (301) 725-1585 Fax: (301) 344-2050 E-Mail: labinfo@fcc.gov

International approvals are slightly more complex, although Linx modules are designed to allow all international standards to be met. If you are considering the export of your product abroad, you should contact Linx Technologies to determine the specific suitability of the module to your application.

All Linx modules are designed with the approval process in mind and thus much of the frustration that is typically experienced with a discrete design is eliminated. Approval is still dependent on many factors, such as the choice of antennas, correct use of the frequency selected, and physical packaging. While some extra cost and design effort are required to address these issues, the additional usefulness and profitability added to a product by RF makes the effort more than worthwhile.

ACHIEVING A SUCCESSFUL RF IMPLEMENTATION

Adding an RF stage brings an exciting new dimension to any product. It also means that additional effort and commitment will be needed to bring the product successfully to market. By utilizing premade RF modules, such as the LR Series, the design and approval process is greatly simplified. It is still important, however, to have an objective view of the steps necessary to ensure a successful RF integration. Since the capabilities of each customer vary widely, it is difficult to recommend one particular design path, but most projects follow steps similar to those shown at the right.

In reviewing this sample design path, you may notice that Linx offers a variety of services (such as antenna design and FCC prequalification) that are unusual for a high-volume component manufacturer. These services, along with an exceptional level of technical support, are offered because we recognize that RF is a complex science requiring the highest caliber of products and support. "Wireless Made Simple" is more than just a motto, it's our commitment. By choosing Linx as your RF partner and taking advantage of the resources we offer, you will not only survive implementing RF, you may even find the process enjoyable.

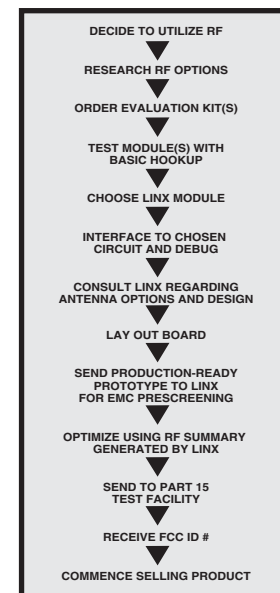

Typical Steps For Implementing RF

HELPFUL APPLICATION NOTES FROM LINX

It is not the intention of this manual to address in depth many of the issues that should be considered to ensure that the modules function correctly and deliver the maximum possible performance. As you proceed with your design, you may wish to obtain one or more of the following application notes, which address in depth key areas of RF design and application of Linx products. These applications notes are available online at www.linxtechnologies.com or by contacting the Linx literature department.

NOTE	APPLICATION NOTE TITLE
AN-00100	RF 101: Information for the RF Challenged
AN-00125	Considerations For Operation Within The 260-470MHz Band
AN-00130	Modulation Techniques For Low-Cost RF Data Links
AN-00140	The FCC Road: Part 15 From Concept To Approval
AN-00150	Use and Design of T-Attenuation Pads
AN-00160	Considerations For Sending Data Over a Wireless Link
AN-00300	Addressing Linx OEM Products
AN-00500	Antennas: Design, Application, Performance



U.S. CORPORATE HEADQUARTERS

LINX TECHNOLOGIES, INC.

**159 ORT LANE
MERLIN, OR 97532**

PHONE: (541) 471-6256

FAX: (541) 471-6251

www.linxtechnologies.com

Disclaimer

LinX Technologies is continually striving to improve the quality and function of its products. For this reason, we reserve the right to make changes without notice. The information contained in this Data Guide is believed to be accurate as of the time of publication. Specifications are based on representative lot samples. Values may vary from lot to lot and are not guaranteed. LinX Technologies makes no guarantee, warranty, or representation regarding the suitability or legality of any product for use in a specific application. None of these devices is intended for use in applications of a critical nature where the safety of life or property is at risk. The user assumes full liability for the use of product in such applications. Under no conditions will LinX Technologies be responsible for losses arising from the use or failure of the device in any application, other than the repair, replacement, or refund limited to the original product purchase price.
