

BGA3031

DOCSIS 3.0 plus upstream amplifier

Rev. 2 — 26 February 2014

Product data sheet

1. General description

The BGA3031 is an upstream amplifier meeting the Data Over Cable Service Interface Specifications (DOCSIS 3.0). It is designed for cable modem, CATV set top box and VoIP modem applications. The device operates from 5 MHz to 85 MHz. The BGA3031 provides 58 dB gain control range in 1 dB increments with high incremental accuracy. Its maximum gain setting delivers 34 dB voltage gain and a superior linear performance.

It supports high output power levels, exceeding the DOCSIS 3.0 power levels while minimizing distortion and output noise levels. The BGA3031 is capable of transmitting 1 to 8 64-QAM and 1 to 8 QPSK modulated carriers while meeting the DOCSIS 3.0 ACLR specification under DOCSIS 3.0 + 4 dB conditions.

The BGA3031 operates at 5 V supply. The gain is controlled via a 3-wire serial interface. The current consumption can be reduced in 4 steps via the serial interface. This enables the user to optimize between DC power efficiency and linearity. In addition the current is automatically reduced at lower gain settings while preserving the linearity performance. In disable mode the device draws typical 6 mA while it still can be programmed to new gain and current settings.

The BGA3031 is housed in 20 pins 5 mm × 5 mm leadless HVQFN package.

2. Features and benefits

- 58 dB gain control range in 1 dB steps using a 3-wire serial interface
- 5 MHz to 85 MHz frequency operating range
- ± 0.2 dB incremental gain step accuracy
- Maximum voltage gain 34 dB
- Excellent IMD3 of -70 dBc at 64 dBmV output power
- Excellent second harmonic level of -80 dBc at 64 dBmV output power
- Excellent third harmonic level of -67 dBc at 64 dBmV output power
- Excellent noise figure of 3.5 dB at maximum gain
- Capable of transmitting 1 to 8 64-QAM modulated carriers while meeting the DOCSIS 3.0 specification under DOCSIS 3.0 + 4 dB conditions (61 dBmV total output power)
- Capable of transmitting 1 to 8 QPSK modulated carriers while meeting the DOCSIS 3.0 specification under DOCSIS 3.0 + 4 dB conditions (65 dBmV total output power)
- 5 V single supply operation
- Excellent ESD protection at all pins
- Unconditionally stable



- Compliant to Directive 2002/95/EC, regarding Restriction of Hazardous Substances (RoHS)

3. Applications

- DOCSIS 3.0 and DOCSIS 3.0 + 4 dB cable modems
- VoIP modems
- Set-top boxes

4. Quick reference data

Table 1. Quick reference data

Typical values at $V_{CC} = 5\text{ V}$; current setting = 3; $T_{case} = 25\text{ °C}$; $Z_i = 200\ \Omega$; $Z_o = 75\ \Omega$, unless otherwise specified.

Symbol	Parameter	Conditions	Min	Typ	Max	Unit
I _{CC}	supply current	transmit-enable mode; TX_EN = HIGH	-	325	-	mA
		transmit-disable mode; TX_EN = LOW	-	6.0	-	mA
G _v	voltage gain	gain code = 111111 [1][2]	-	34	-	dB
NF	noise figure	transmit-enable mode; gain code = 111111	-	3.5	-	dB
α _{2H}	second harmonic level	P _i = 30 dBmV; P _L = 64 dBmV into 75 Ω differential impedance	-	-80	-	dBc
α _{3H}	third harmonic level	P _i = 30 dBmV; P _L = 64 dBmV into 75 Ω differential impedance	-	-67	-	dBc
IMD3	third-order intermodulation distortion	P _i = 27 dBmV per tone; P _L = 61 dBmV per tone into 75 Ω differential impedance	-	-70	-	dBc
P _{L(1dB)}	output power at 1 dB gain compression	signal	-	74	-	dBmV

[1] Voltage gain does not include loss due to input and output transformers.

[2] P_i = 30 dBmV.

Table 2. ACLR quick reference data

Typical values at $V_{CC} = 5\text{ V}$; current setting = 3; $T_{case} = 25\text{ °C}$; $Z_i = 200\ \Omega$; $Z_o = 75\ \Omega$; channel bandwidth = 1280 kHz; integration bandwidth = 1280 kHz; $f = 5\text{ MHz to }85\text{ MHz}$, unless otherwise specified.

Symbol	Parameter	Conditions	DOCSIS 3.0 spec.	Min	Typ	Max	Unit
DOCSIS 3.0 + 4 dB; 64-QAM							
ACLR	adjacent channel leakage ratio	P _i = 29 dBmV; P _L = 61 dBmV					
		1 input channel	-50	-	-68	-	dBc
		2 input channels	-47	-	-62	-	dBc
		4 input channels	-44	-	-58	-	dBc
		8 input channels	-	-	-56	-	dBc
DOCSIS 3.0 + 4 dB; QPSK							
ACLR	adjacent channel leakage ratio	P _i = 33 dBmV; P _L = 65 dBmV					
		1 input channel	-50	-	-66	-	dBc
		2 input channels	-47	-	-58	-	dBc
		4 input channels	-44	-	-50	-	dBc
		8 input channels	-	-	-42	-	dBc

5. Ordering information

Table 3. Ordering information

Type number	Package		Version
	Name	Description	
BGA3031	HVQFN20	plastic thermal enhanced very thin quad flat package; no leads; 20 terminals; body 5 × 5 × 0.85 mm	SOT662-1

6. Functional diagram

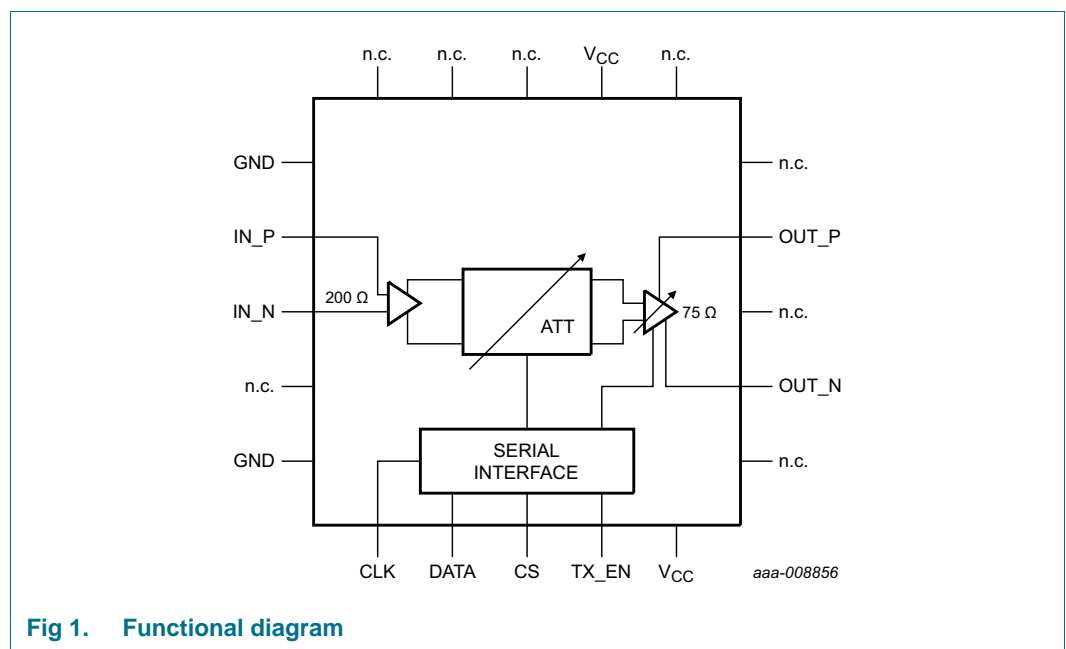

Fig 1. Functional diagram

7. Pinning information

7.1 Pinning

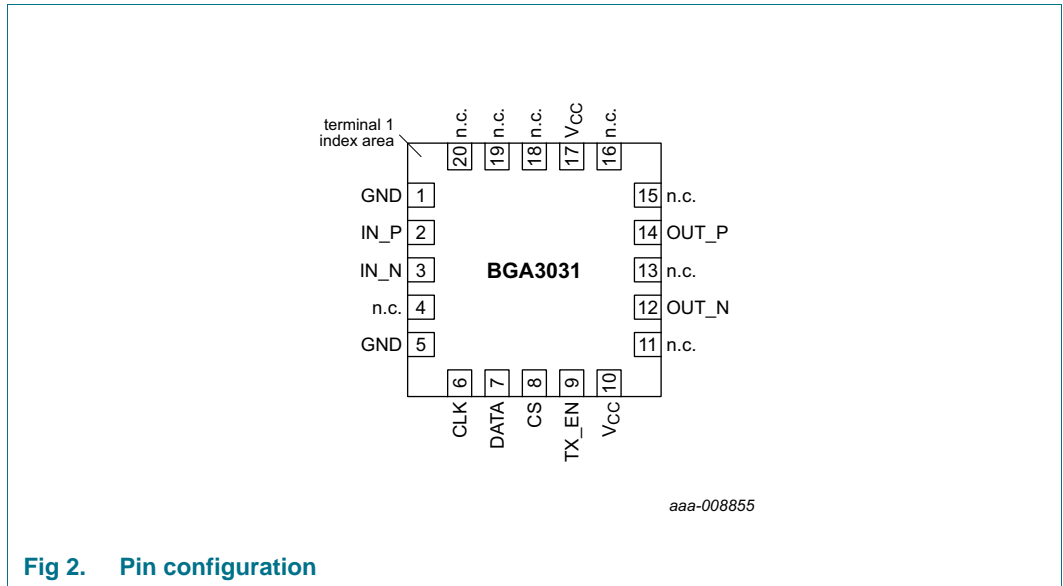

Fig 2. Pin configuration

7.2 Pin description

Table 4. Pin description

Symbol	Pin	Description
GND	1	ground
IN_P	2	amplifier input +
IN_N	3	amplifier input –
n.c.	4	not connected
GND	5	ground
CLK	6	clock
DATA	7	data
CS	8	chip select
TX_EN	9	transmit enable
V _{CC}	10	supply voltage for serial interface
n.c.	11	not connected
OUT_N	12	amplifier output –
n.c.	13	not connected
OUT_P	14	amplifier output +
n.c.	15	not connected
n.c.	16	not connected
V _{CC}	17	supply voltage for Variable Gain Amplifier (VGA)
n.c.	18	not connected

Table 4. Pin description ...continued

Symbol	Pin	Description
n.c.	19	not connected
n.c.	20	not connected
Paddle		ground

8. Functional description

8.1 Logic programming

The programming word is set through a shift register via the data, clock and chip select lines. The data is entered in order with the Most Significant Bit (MSB) first and the Least Significant Bit (LSB) last. The chip select line must be LOW for the duration of the data entry, then set HIGH to latch the shift register. The rising edge of the clock pulse shifts each data value into the register.

Table 5. Programming register

Data bit	11	10	9	8	7	6	5	4	3	2	1	0
Function	Register address				Current setting [1]		attenuation (gain) setting [2]					
Initialize	0	0	0	1	0	0	0	0	0	0	0	0
Set gain	0	0	0	0	C[1]	C[0]	G[5]	G[4]	G[3]	G[2]	G[1]	G[0]

[1] For current bit settings see [Table 7](#).

[2] For gain bit settings see [Table 6](#).

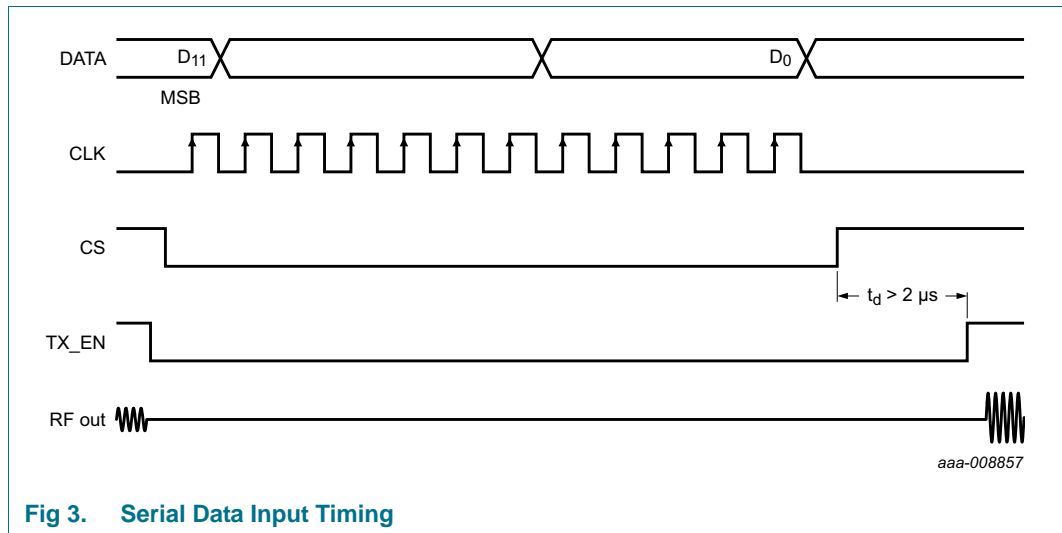

8.2 Register settings

8.2.1 Register address

Only addresses 0000 and 0001 are used. Using any other addresses will not affect the VGA.

8.2.2 Gain/attenuator setting

The gain shall be controlled via the 3-wire bus. Data bits D0 through D5 set the gain/attenuator level, with 111111 being the min attenuation setting, and 000101 being the max attenuation setting. A new gain/attenuator setting can be loaded while the VGA is on (transmit-enable), but shall not take effect until transmit-enable transitions from LOW to HIGH.

Table 6. Gain settings

Gain setting G[5:0]		Typical gain (dB)
binary notation	decimal notation	
000000 to 000101	0 to 5	-24
000110 [1]	6 [1]	-23
111110 [1]	62 [1]	33
111111 [1]	63 [1]	34

[1] With every increment of the gain setting between 000110 (6) and 111111 (63) the typical gain will increase accordingly.

8.2.3 Output stage current setting

The current (of the output stage) shall be controlled via the 3-wire bus. Data bits D6 and D7 set the current. Setting 11 will set the maximum current for maximum linearity. The current can be lowered for improved efficiency at lower output power levels, or lower linearity requirements. Setting 00 will set the minimum current. A new current setting can be loaded while the VGA is on (transmit-enable), but shall not take effect until transmit-enable transitions from LOW to HIGH.

Table 7. Supply current settings

At gain setting 63.

Current setting C[1:0]		Typical supply current (mA)
binary notation	decimal notation	
00	0	215
01	1	260
10	2	290
11	3	325

The current is automatically reduced at lower gain settings while preserving the linearity performance.

Table 8. Supply current versus gain setting

Gain setting G[5:0]		Typical current (mA)			
binary notation	decimal notation	Current setting C[1:0] 00 (decimal = 0)	Current setting C[1:0] 01 (decimal = 1)	Current setting C[1:0] 10 (decimal = 2)	Current setting C[1:0] 11 (decimal = 3)
111111	63	215	260	290	325
110111	55	215	260	290	325
110110	54	165	190	200	215
110001	49	165	190	200	215
110000	48	135	150	160	160
101000	40	135	150	160	160
100111	39	120	125	125	125
000101	5	120	125	125	125

8.3 Tx enable / Tx disable

The amplifier can be disabled or enabled by making TX_EN (pin 9) LOW or HIGH. A LOW to HIGH Tx enable transition will activate new programmed settings. If no new settings are programmed the last programmed setting will be re-activated.

9. Limiting values

Table 9. Limiting values

In accordance with the Absolute Maximum Rating System (IEC 60134).

Absolute Maximum Ratings are given as Limiting Values of stress conditions during operation, that must not be exceeded under the worst probable conditions.

Symbol	Parameter	Conditions	Min	Max	Unit
V _{CC}	supply voltage		-	6.0	V
V _I	input voltage	on pin IN_P	-0.5	+6.0	V
		on pin IN_N	-0.5	+6.0	V
		on pin CLK	[1] -0.5	+6.0	V
		on pin DATA	[1] -0.5	+6.0	V
		on pin CS	[1] -0.5	+6.0	V
		on pin TX_EN	[1] -0.5	+6.0	V
		on pin OUT_N	-0.5	+6.0	V
		on pin OUT_P	-0.5	+6.0	V
P _{i(max)}	maximum input power		-	40	dBmV
T _{stg}	storage temperature		-65	+150	°C
T _j	junction temperature		-	150	°C
V _{ESD}	electrostatic discharge voltage	Human Body Model (HBM); According JEDEC standard 22-A114E	-	4000	V
		Charged Device Model (CDM); According JEDEC standard 22-C101B	-	2000	V

[1] All digital pins may not exceed V_{CC} as the internal ESD circuit can be damaged. To prevent this it is recommended that control pins are limited to a maximum of 5 mA.

10. Thermal characteristics

Table 10. Thermal characteristics

Symbol	Parameter	Conditions	Typ	Unit
$R_{th(j-bop)}$	thermal resistance from junction to bottom of package	in free air	[1] 14	K/W
$R_{th(j-a)}$	thermal resistance from junction to ambient	in free air	[2] 35	K/W

[1] Simulated using final element method model resembling the device mounted on the application board. See [Section 13](#).

[2] Device mounted on application board.

11. Static characteristics

Table 11. Characteristics

Typical values at $V_{CC} = 5\text{ V}$; current setting = 3; $T_{case} = 25\text{ °C}$; $Z_i = 200\ \Omega$; $Z_o = 75\ \Omega$, unless otherwise specified.

Symbol	Parameter	Conditions	Min	Typ	Max	Unit
I_{CC}	supply current	transmit-enable mode; TX_EN = HIGH	-	325	-	mA
		transmit-disable mode; TX_EN = LOW	-	6.0	-	mA
V_{IH}	HIGH-level input voltage	[1] 2.0	-	$V_{CC} + 0.6$	V	
V_{IL}	LOW-level input voltage	[1] 0	-	0.8	V	
P	power dissipation	-	-	1.625	W	

[1] Voltage on the control pins.

12. Dynamic characteristics

Table 12. Characteristics

Typical values at $V_{CC} = 5\text{ V}$; current setting = 3; $Z_i = 200\ \Omega$; $Z_o = 75\ \Omega$; $T_{case} = 25\ ^\circ\text{C}$, unless otherwise specified.

Symbol	Parameter	Conditions	Min	Typ	Max	Unit	
G_v	voltage gain	gain code = 111111	[1][2]	-	34	-	dB
		gain code = 000000	[1][2]	-	-24	-	dB
G_{flat}	gain flatness	f = 5 MHz to 42 MHz	[2]	-	± 0.4	-	dB
		f = 5 MHz to 85 MHz	[2]	-	± 0.6	-	dB
G_{step}	gain step		[2]	-	1.0	-	dB
$E_{G(dif)}$	differential gain error		[2]	-	± 0.2	-	dB
$R_{i(dif)}$	differential input resistance		-	200	-	Ω	
$R_{o(dif)}$	differential output resistance		-	75	-	Ω	
f_{range}	frequency range		5	-	85	MHz	
P_n	noise power	transmit-disable mode; TX_EN = LOW; any bandwidth = 160 kHz from f = 5 MHz to 85 MHz	-	-69	-	dBmV	
α_{isol}	isolation	transmit-disable mode; TX_EN = LOW; f = 85 MHz	-	-90	-	dB	
NF	noise figure	transmit mode; gain code = 111111	-	3.5	-	dB	
		transmit mode; gain code = 101110	-	6.5	-	dB	
$t_{sw(G)}$	gain switch time	transmit-disable/transmit-enable transient duration	-	1.8	-	μs	
V_{os}	overshoot voltage	transmit-disable/transmit-enable transient step size					
		55 dBmV output power	-	80	-	mV(p-p)	
		49 dBmV output power	-	50	-	mV(p-p)	
		43 dBmV output power	-	25	-	mV(p-p)	
		37 dBmV output power	-	5	-	mV(p-p)	
α_{2H}	second harmonic level	$P_i = 30\text{ dBmV}$; $P_L = 64\text{ dBmV}$ into 75 Ω differential impedance	-	-80	-	dBc	
α_{3H}	third harmonic level	$P_i = 30\text{ dBmV}$; $P_L = 64\text{ dBmV}$ into 75 Ω differential impedance	-	-67	-	dBc	
IMD3	third-order intermodulation distortion	$P_i = 27\text{ dBmV}$ per tone; $P_L = 61\text{ dBmV}$ per tone into 75 Ω differential impedance	-	-70	-	dBc	
$P_{L(1dB)}$	output power at 1 dB gain compression	CW signal	-	74	-	dBmV	

[1] Voltage gain does not include loss due to input and output transformers.

[2] $P_i = 30\text{ dBmV}$.

Table 13. ACLR characteristics

Typical values at $V_{CC} = 5\text{ V}$; current setting = 3; $T_{case} = 25\text{ °C}$; $Z_i = 200\ \Omega$; $Z_o = 75\ \Omega$; channel bandwidth = 1280 kHz; integration bandwidth = 1280 kHz; $f = 5\text{ MHz to }85\text{ MHz}$, unless otherwise specified.

Symbol	Parameter	Conditions	DOCSIS 3.0 spec.	Min	Typ	Max	Unit
DOCSIS 3.0; 64-QAM							
ACLR	adjacent channel leakage ratio	$P_i = 29\text{ dBmV}$; $P_L = 57\text{ dBmV}$					
		1 input channel	-50	-	-68	-	dBc
		2 input channels	-47	-	-62	-	dBc
		4 input channels	-44	-	-58	-	dBc
		8 input channels	-	-	-56	-	dBc
DOCSIS 3.0; QPSK							
ACLR	adjacent channel leakage ratio	$P_i = 33\text{ dBmV}$; $P_L = 61\text{ dBmV}$					
		1 input channel	-50	-	-66	-	dBc
		2 input channels	-47	-	-58	-	dBc
		4 input channels	-44	-	-54	-	dBc
		8 input channels	-	-	-52	-	dBc
DOCSIS 3.0 + 3 dB; 64-QAM							
ACLR	adjacent channel leakage ratio	$P_i = 29\text{ dBmV}$; $P_L = 60\text{ dBmV}$					
		1 input channel	-50	-	-68	-	dBc
		2 input channels	-47	-	-62	-	dBc
		4 input channels	-44	-	-58	-	dBc
		8 input channels	-	-	-56	-	dBc
DOCSIS 3.0 + 3 dB; QPSK							
ACLR	adjacent channel leakage ratio	$P_i = 33\text{ dBmV}$; $P_L = 64\text{ dBmV}$					
		1 input channel	-50	-	-66	-	dBc
		2 input channels	-47	-	-58	-	dBc
		4 input channels	-44	-	-54	-	dBc
		8 input channels	-	-	-48	-	dBc
DOCSIS 3.0 + 4 dB; 64-QAM							
ACLR	adjacent channel leakage ratio	$P_i = 29\text{ dBmV}$; $P_L = 61\text{ dBmV}$					
		1 input channel	-50	-	-68	-	dBc
		2 input channels	-47	-	-62	-	dBc
		4 input channels	-44	-	-58	-	dBc
		8 input channels	-	-	-56	-	dBc
DOCSIS 3.0 + 4 dB; QPSK							
ACLR	adjacent channel leakage ratio	$P_i = 33\text{ dBmV}$; $P_L = 65\text{ dBmV}$					
		1 input channel	-50	-	-66	-	dBc
		2 input channels	-47	-	-58	-	dBc
		4 input channels	-44	-	-50	-	dBc
		8 input channels	-	-	-42	-	dBc

13. Application information

13.1 External components

Matching the balanced output of the chip to a single-ended 75 Ω load is accomplished using a 1 : 1 ratio transformer. For measurements in a 50 Ω system R7 and R8 are added for impedance transformation from 75 Ω to 50 Ω. R7 and R8 are not required in the final application.

The transformer also cancels even mode distortion products and common mode signals, such as the voltage transients that occur while enabling and disabling the amplifiers. External capacitors are needed for the functionality of the circuit, the pins are internal nodes in the output amplifier.

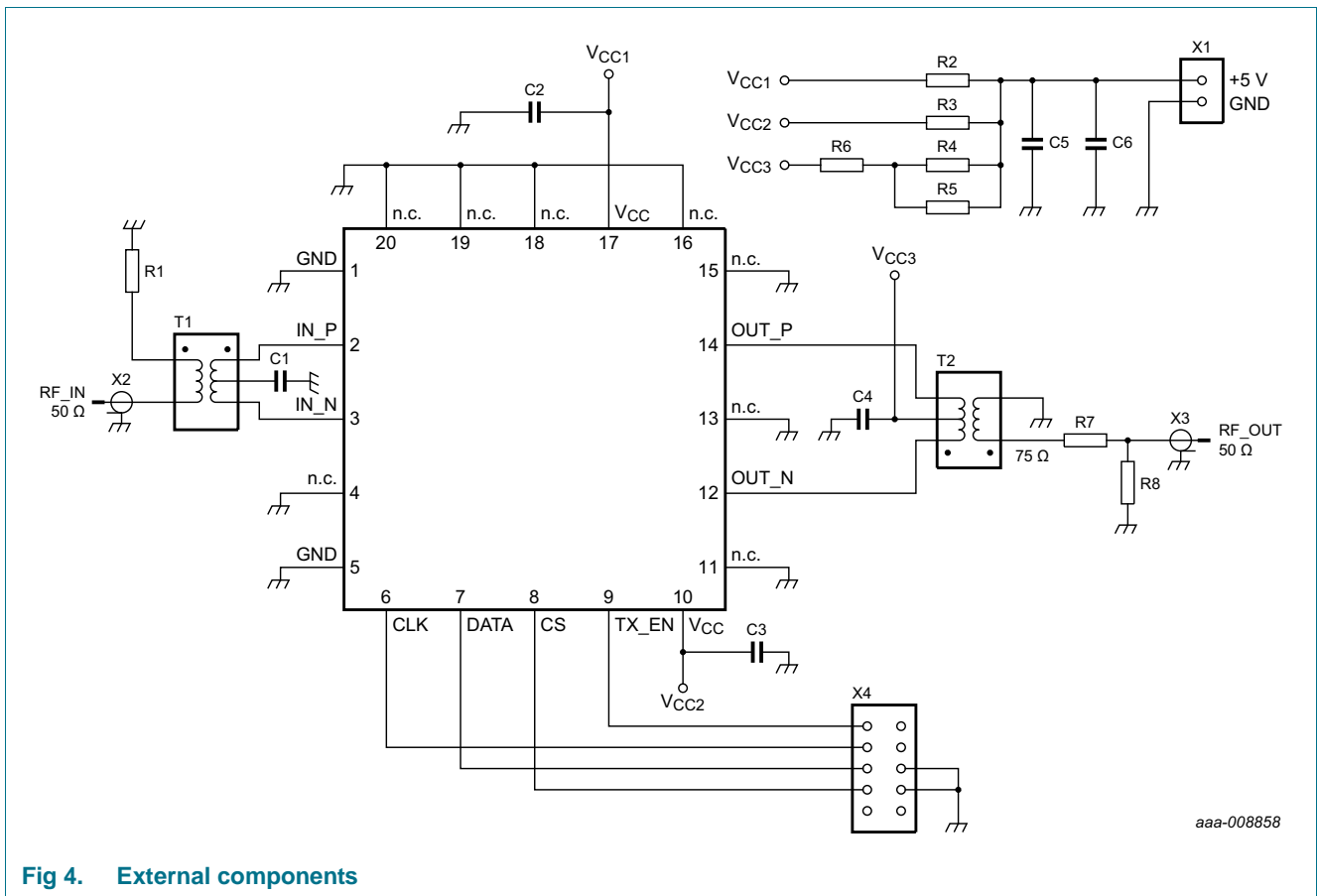

Fig 4. External components

Table 14. List of components
For application diagram, see Figure 4.

Component	Description	Value	Size	Supplier: Part No.
C1, C2, C3, C4	capacitor	10 nF	SMD 0603	
C5	capacitor	100 nF	SMD 0603	
C6	capacitor	10 μF	SMD 1206	
R1, R6	resistor	0 Ω	SMD 0603	
R2, R3	resistor	0 Ω	SMD 0805	
R4, R5	resistor	4.7 Ω	SMD 0603	

Table 14. List of components ...continued
 For application diagram, see [Figure 4](#).

Component	Description	Value	Size	Supplier: Part No.
R7	resistor	43.3 Ω	SMD 0603	
R8	resistor	86.6 Ω	SMD 0603	
T1	input balun	-	-	TOKO: #617DB-1714
T2	output balun	-	-	M/A-COM: MABA-009572-CF18A0
X1	2-pin header	-	-	
X2, X3	SMA connector	-	-	
X4	10-pin header	-	-	FCI: Minitek

13.2 Graphs

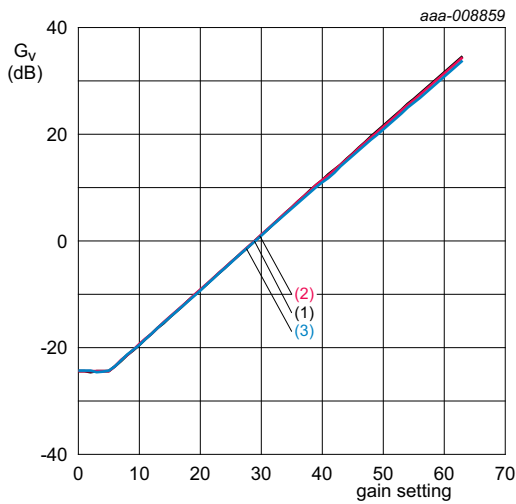

$V_{CC} = 5\text{ V}$; current setting = 3; $T_{case} = 25\text{ }^\circ\text{C}$;
 $P_i = 30\text{ dBmV}$.

- (1) $f = 5\text{ MHz}$
- (2) $f = 42\text{ MHz}$
- (3) $f = 85\text{ MHz}$

Fig 5. Voltage gain as a function of gain setting; typical values

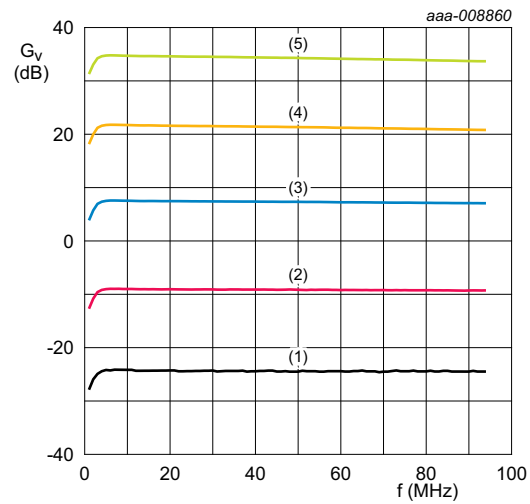

$V_{CC} = 5\text{ V}$; current setting = 3; $T_{case} = 25\text{ }^\circ\text{C}$;
 $P_i = 30\text{ dBmV}$.

- (1) gain setting = 5
- (2) gain setting = 20
- (3) gain setting = 36
- (4) gain setting = 50
- (5) gain setting = 63

Fig 6. Voltage gain as a function of frequency; typical values

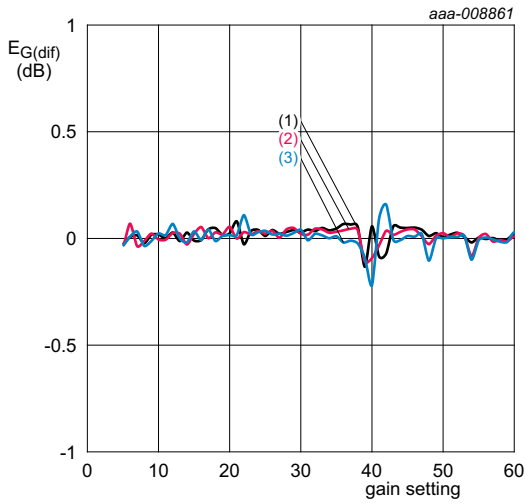

$V_{CC} = 5\text{ V}$; current setting = 3; $T_{case} = 25\text{ }^{\circ}\text{C}$;
 $P_i = 30\text{ dBmV}$.

- (1) $f = 5\text{ MHz}$
- (2) $f = 42\text{ MHz}$
- (3) $f = 85\text{ MHz}$

Fig 7. Differential gain error as a function of gain setting; typical values

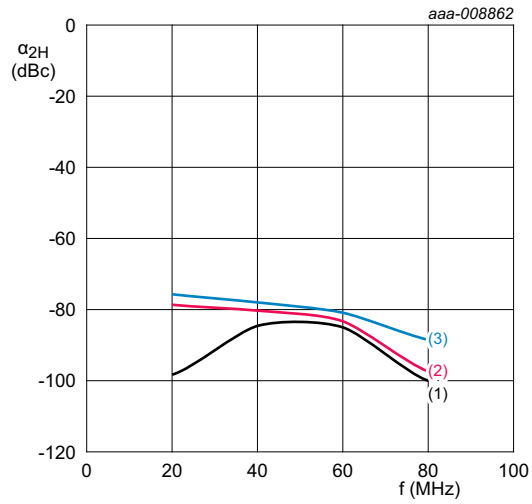

$V_{CC} = 5\text{ V}$; $P_i = 30\text{ dBmV}$; $P_L = 64\text{ dBmV}$;
 current setting = 3; gain setting = 63.

- (1) $T_{case} = -10\text{ }^{\circ}\text{C}$
- (2) $T_{case} = +25\text{ }^{\circ}\text{C}$
- (3) $T_{case} = +85\text{ }^{\circ}\text{C}$

Fig 8. Second harmonic level as a function of frequency; typical values

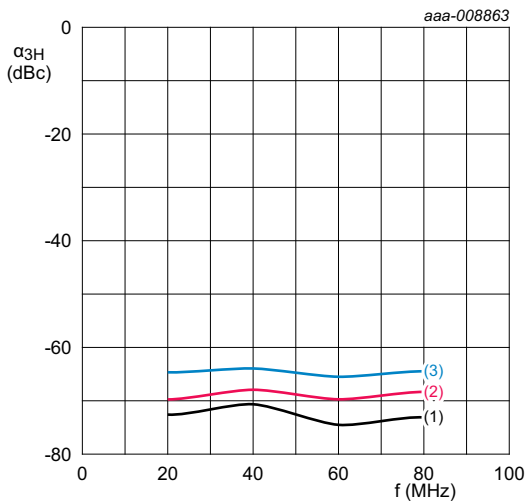

$V_{CC} = 5\text{ V}$; $P_i = 30\text{ dBmV}$; $P_L = 64\text{ dBmV}$;
 current setting = 3; gain setting = 63.

- (1) $T_{case} = -10\text{ }^{\circ}\text{C}$
- (2) $T_{case} = +25\text{ }^{\circ}\text{C}$
- (3) $T_{case} = +85\text{ }^{\circ}\text{C}$

Fig 9. Third harmonic level as a function of frequency; typical values

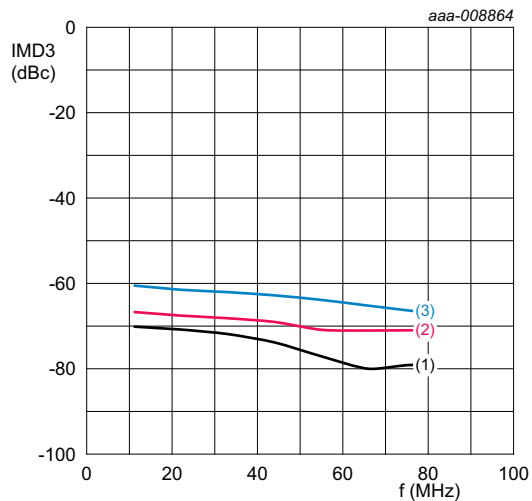

$V_{CC} = 5\text{ V}$; $P_i = 27\text{ dBmV}$ per tone; $P_L = 61\text{ dBmV}$ per tone;
 current setting = 3; gain setting = 63.

- (1) $T_{case} = -10\text{ }^{\circ}\text{C}$
- (2) $T_{case} = +25\text{ }^{\circ}\text{C}$
- (3) $T_{case} = +85\text{ }^{\circ}\text{C}$

Fig 10. Third order intermodulation distortion as a function of frequency; typical values

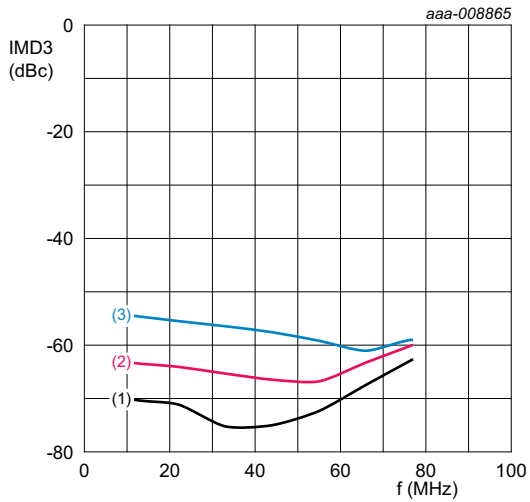

$V_{CC} = 5\text{ V}$; $P_i = 30\text{ dBmV}$ per tone; $P_L = 64\text{ dBmV}$ per tone; current setting = 3; gain setting = 63.

- (1) $T_{case} = -10\text{ °C}$
- (2) $T_{case} = +25\text{ °C}$
- (3) $T_{case} = +85\text{ °C}$

Fig 11. Third order intermodulation distortion as a function of frequency; typical values

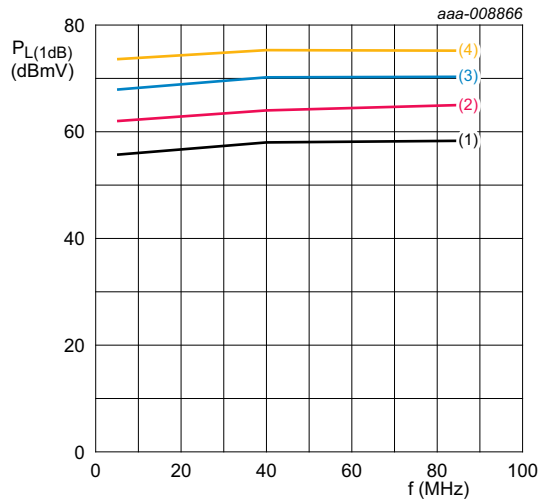

$V_{CC} = 5\text{ V}$; current setting = 3; $T_{case} = 25\text{ °C}$; $P_i = 30\text{ dBmV}$.

- (1) gain setting = 39
- (2) gain setting = 48
- (3) gain setting = 54
- (4) gain setting = 63

Fig 12. Output power at 1 dB gain compression as a function of frequency; typical values

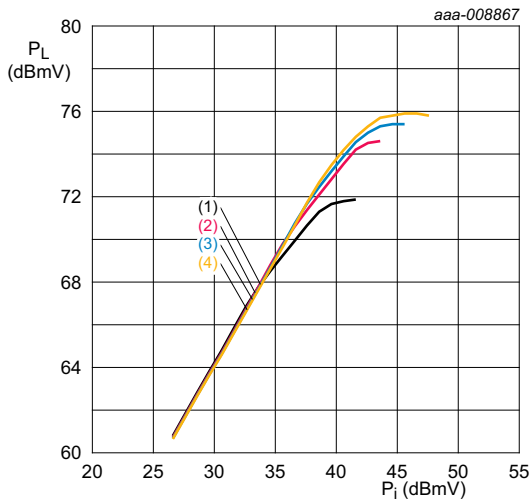

$T_{case} = 25\text{ °C}$; $V_{CC} = 5\text{ V}$; $f = 85\text{ MHz}$; gain setting = 63.

- (1) current setting = 0
- (2) current setting = 1
- (3) current setting = 2
- (4) current setting = 3

Fig 13. Output power as a function of input power; typical values

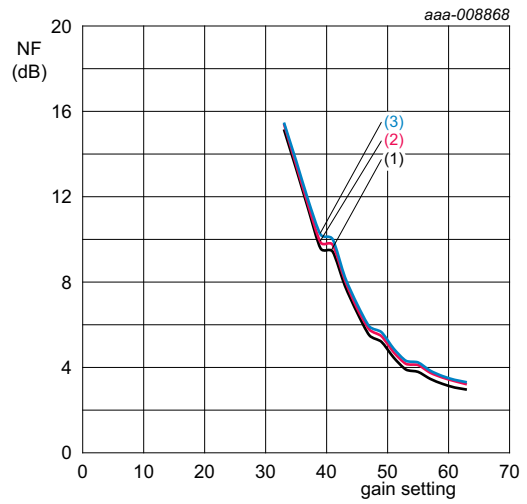

$T_{case} = 25\text{ °C}$; $V_{CC} = 5\text{ V}$; current setting = 3.

- (1) $f = 5\text{ MHz}$
- (2) $f = 42\text{ MHz}$
- (3) $f = 85\text{ MHz}$

Fig 14. Noise figure as a function of gain setting; typical values

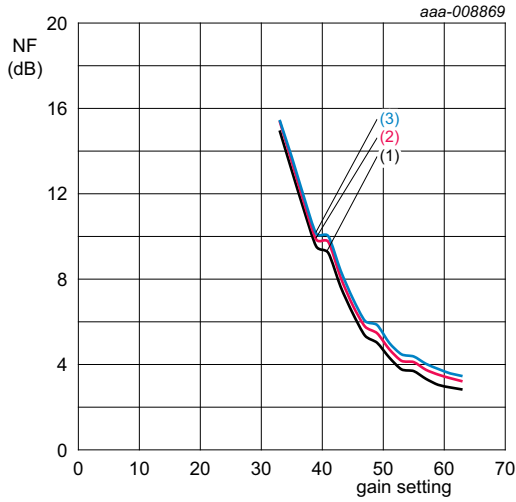

$f = 45 \text{ MHz}$; $V_{CC} = 5 \text{ V}$; current setting = 3.
 (1) $T_{case} = -10 \text{ }^\circ\text{C}$
 (2) $T_{case} = +25 \text{ }^\circ\text{C}$
 (3) $T_{case} = +85 \text{ }^\circ\text{C}$

Fig 15. Noise figure as a function of gain setting; typical values

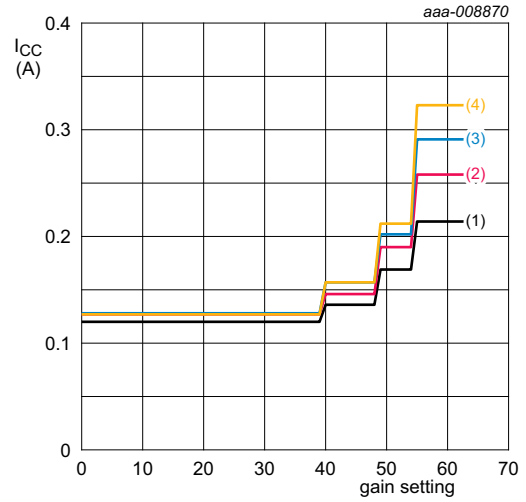

$T_{case} = 25 \text{ }^\circ\text{C}$; $V_{CC} = 5 \text{ V}$.
 (1) current setting = 0
 (2) current setting = 1
 (3) current setting = 2
 (4) current setting = 3

Fig 16. Supply current as a function of gain setting; typical values

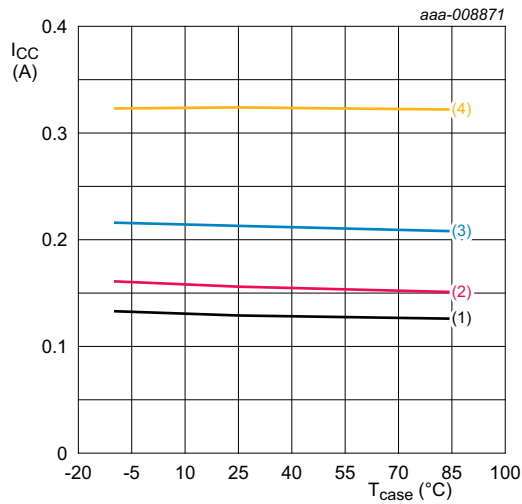

$T_{case} = 25 \text{ }^\circ\text{C}$; $V_{CC} = 5 \text{ V}$; current setting = 3.
 (1) gain setting = 20
 (2) gain setting = 44
 (3) gain setting = 52
 (4) gain setting = 60

Fig 17. Supply current as a function of case temperature; typical values

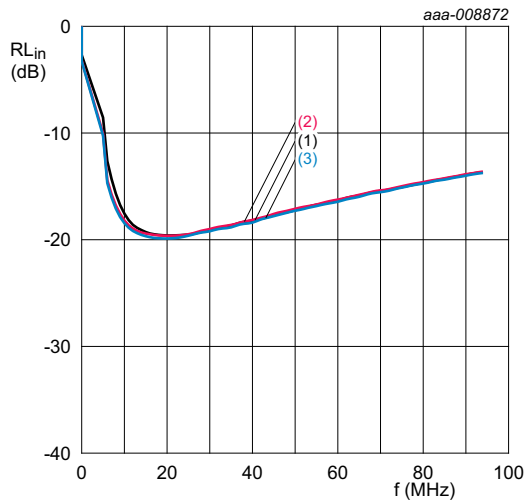

$T_{case} = 25 \text{ }^\circ\text{C}$; $V_{CC} = 5 \text{ V}$; current setting = 3.
 (1) gain setting = 5
 (2) gain setting = 36
 (3) gain setting = 63

Fig 18. Input return loss as a function of frequency; typical values

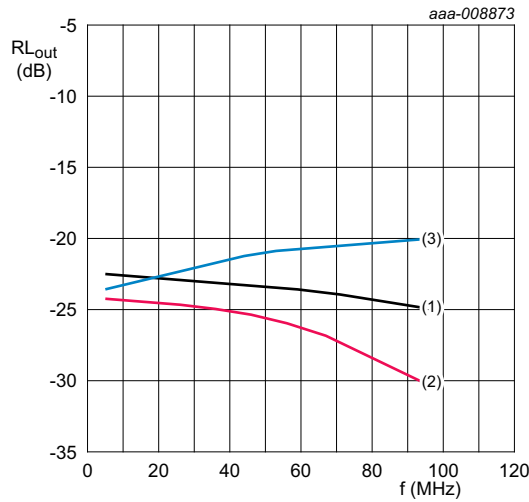

$T_{case} = 25\text{ }^{\circ}\text{C}$; $V_{CC} = 5\text{ V}$; current setting = 3.

- (1) gain setting = 5
- (2) gain setting = 63
- (3) amplifier disabled (TX_EN LOW)

Fig 19. Output return loss as a function of frequency; typical values

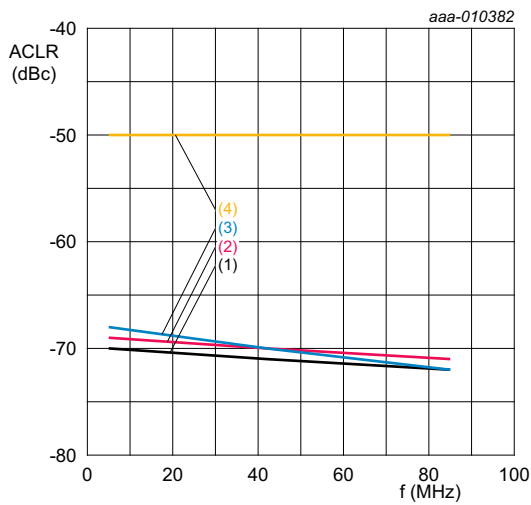

One carrier 64-QAM; $T_{case} = 25\text{ }^{\circ}\text{C}$; $V_{CC} = 5\text{ V}$; max. current; $P_i = 29\text{ dBmV}$.

- (1) $P_L = 57\text{ dBmV}$
- (2) $P_L = 60\text{ dBmV}$
- (3) $P_L = 61\text{ dBmV}$
- (4) DOCSIS 3.0 specification

Fig 20. Adjacent channel leakage ratio as a function of frequency; typical values

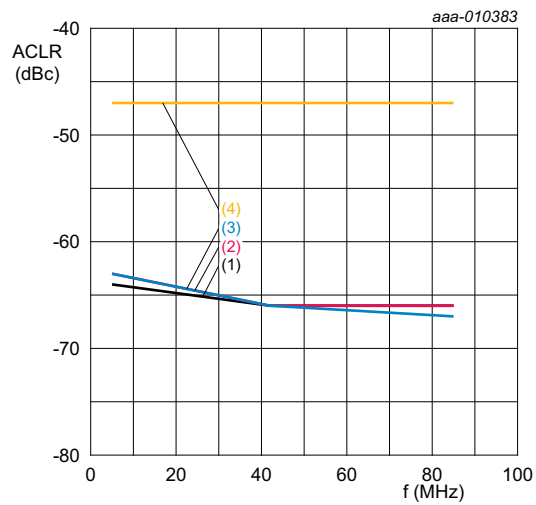

Two carrier 64-QAM; $T_{case} = 25\text{ }^{\circ}\text{C}$; $V_{CC} = 5\text{ V}$; max. current; $P_i = 29\text{ dBmV}$.

- (1) $P_L = 57\text{ dBmV}$
- (2) $P_L = 60\text{ dBmV}$
- (3) $P_L = 61\text{ dBmV}$
- (4) DOCSIS 3.0 specification

Fig 21. Adjacent channel leakage ratio as a function of frequency; typical values

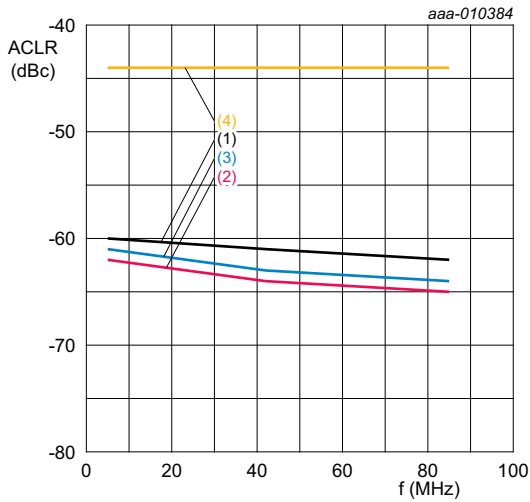

Four carrier 64-QAM; $T_{case} = 25\text{ }^{\circ}\text{C}$; $V_{CC} = 5\text{ V}$; max. current; $P_i = 29\text{ dBmV}$.

- (1) $P_L = 57\text{ dBmV}$
- (2) $P_L = 60\text{ dBmV}$
- (3) $P_L = 61\text{ dBmV}$
- (4) DOCSIS 3.0 specification

Fig 22. Adjacent channel leakage ratio as a function of frequency; typical values

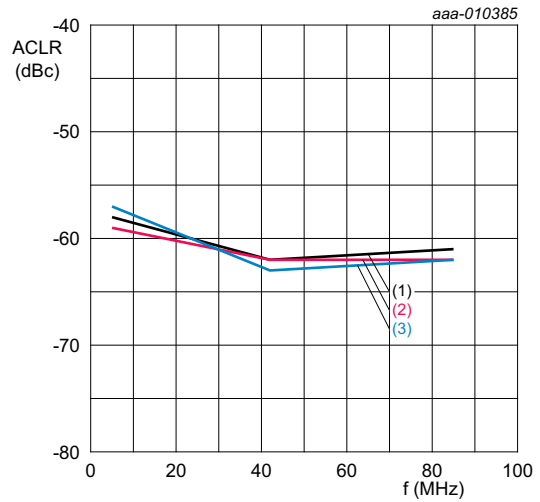

Eight carrier 64-QAM; $T_{case} = 25\text{ }^{\circ}\text{C}$; $V_{CC} = 5\text{ V}$; max. current; $P_i = 29\text{ dBmV}$.

- (1) $P_L = 57\text{ dBmV}$
- (2) $P_L = 60\text{ dBmV}$
- (3) $P_L = 61\text{ dBmV}$

Fig 23. Adjacent channel leakage ratio as a function of frequency; typical values

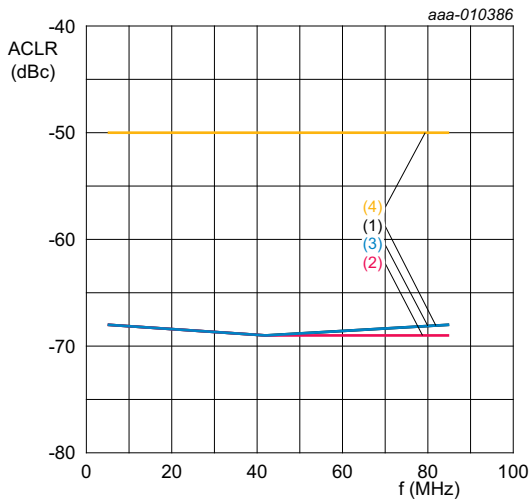

One carrier QPSK; $T_{case} = 25\text{ }^{\circ}\text{C}$; $V_{CC} = 5\text{ V}$; max. current; $P_i = 33\text{ dBmV}$.

- (1) $P_L = 61\text{ dBmV}$
- (2) $P_L = 64\text{ dBmV}$
- (3) $P_L = 65\text{ dBmV}$
- (4) DOCSIS 3.0 specification

Fig 24. Adjacent channel leakage ratio as a function of frequency; typical values

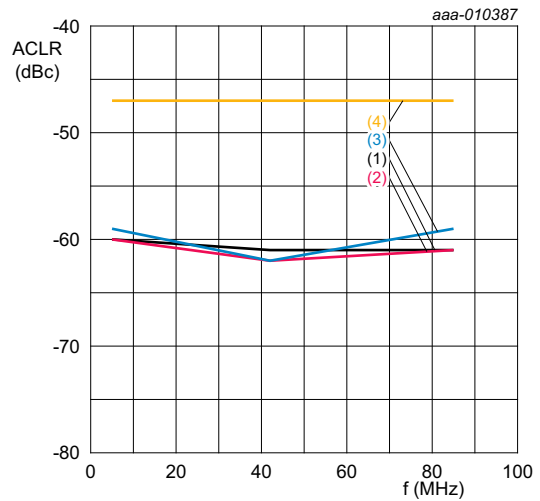

Two carrier QPSK; $T_{case} = 25\text{ }^{\circ}\text{C}$; $V_{CC} = 5\text{ V}$; max. current; $P_i = 33\text{ dBmV}$.

- (1) $P_L = 61\text{ dBmV}$
- (2) $P_L = 64\text{ dBmV}$
- (3) $P_L = 65\text{ dBmV}$
- (4) DOCSIS 3.0 specification

Fig 25. Adjacent channel leakage ratio as a function of frequency; typical values

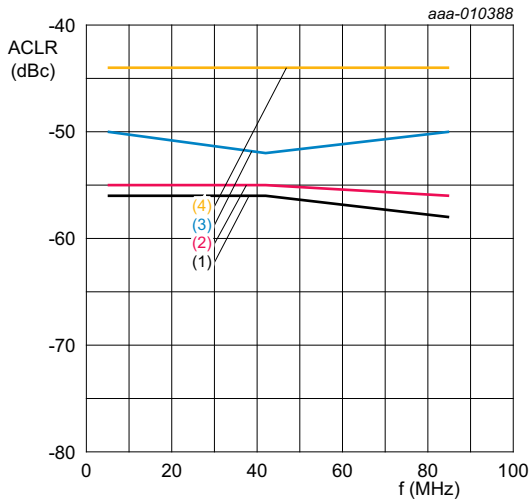

Four carrier QPSK; $T_{case} = 25\text{ }^{\circ}\text{C}$; $V_{CC} = 5\text{ V}$; max. current; $P_i = 33\text{ dBmV}$.

- (1) $P_L = 61\text{ dBmV}$
- (2) $P_L = 64\text{ dBmV}$
- (3) $P_L = 65\text{ dBmV}$
- (4) DOCSIS 3.0 specification

Fig 26. Adjacent channel leakage ratio as a function of frequency; typical values

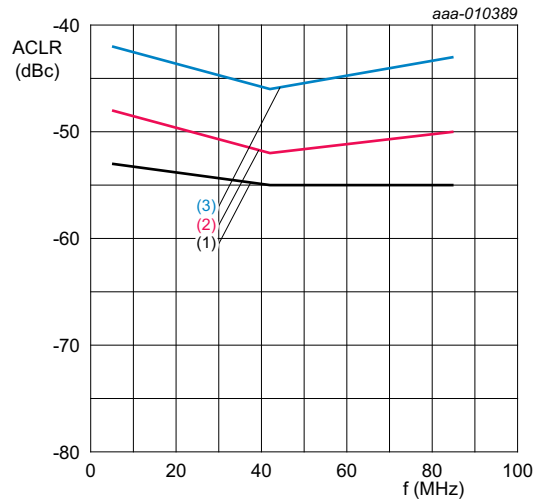

Eight carrier QPSK; $T_{case} = 25\text{ }^{\circ}\text{C}$; $V_{CC} = 5\text{ V}$; max. current; $P_i = 33\text{ dBmV}$.

- (1) $P_L = 61\text{ dBmV}$
- (2) $P_L = 64\text{ dBmV}$
- (3) $P_L = 65\text{ dBmV}$

Fig 27. Adjacent channel leakage ratio as a function of frequency; typical values

14. Package outline

HVQFN20: plastic thermal enhanced very thin quad flat package; no leads;
20 terminals; body 5 x 5 x 0.85 mm

SOT662-1

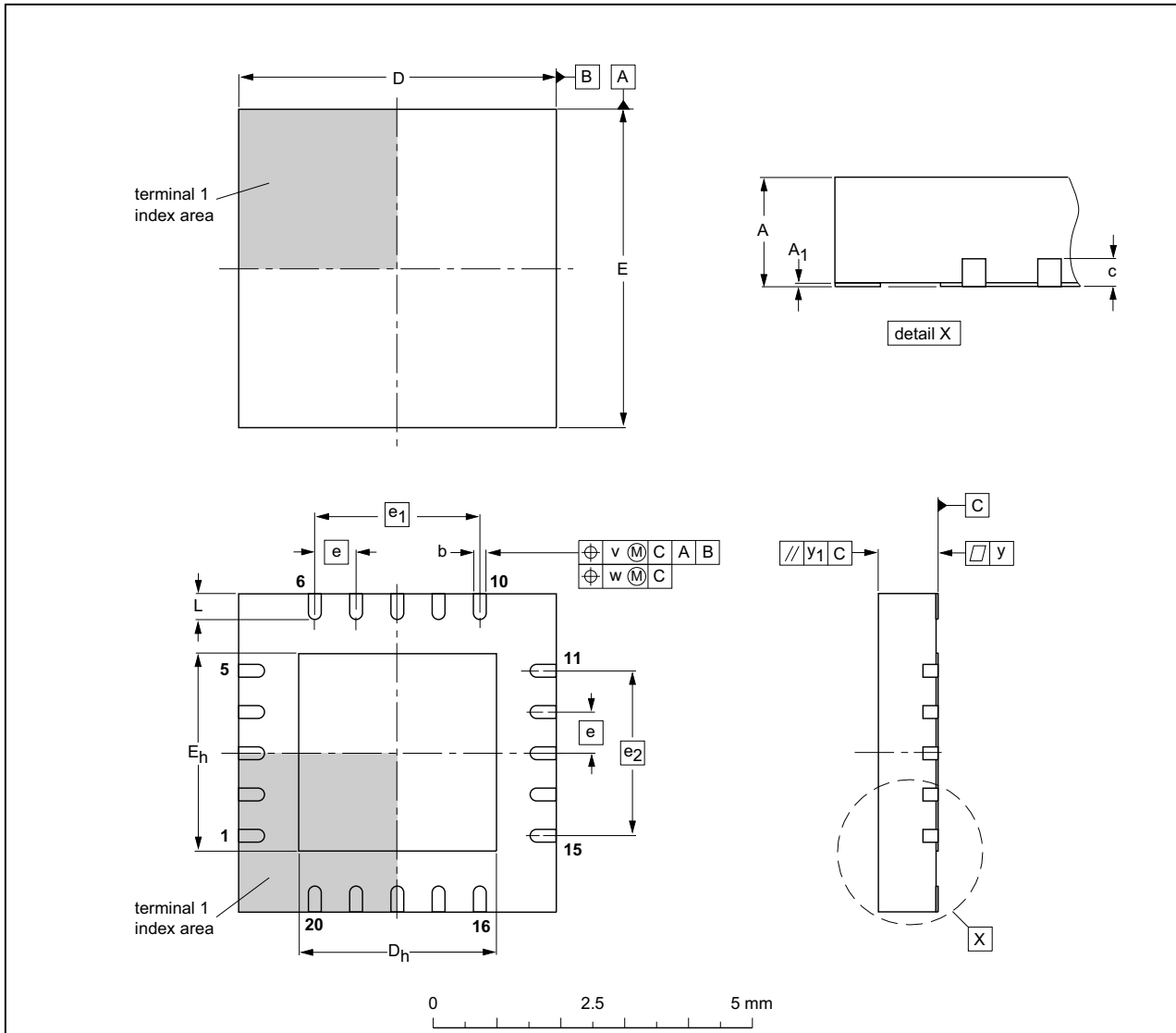

DIMENSIONS (mm are the original dimensions)

UNIT	A ⁽¹⁾ max.	A ₁	b	c	D ⁽¹⁾	D _h	E ⁽¹⁾	E _h	e	e ₁	e ₂	L	v	w	y	y ₁
mm	1	0.05 0.00	0.38 0.23	0.2	5.1 4.9	3.25 2.95	5.1 4.9	3.25 2.95	0.65	2.6	2.6	0.75 0.50	0.1	0.05	0.05	0.1

Note

1. Plastic or metal protrusions of 0.075 mm maximum per side are not included.

OUTLINE VERSION	REFERENCES				EUROPEAN PROJECTION	ISSUE DATE
	IEC	JEDEC	JEITA			
SOT662-1	---	MO-220	---			01-08-08 02-10-22

Fig 28. Package outline SOT662-1 (HVQFN20)

15. Handling information

15.1 Moisture sensitivity

Table 15. Moisture sensitivity level

Test methodology	Class
JESD-22-A113	1

16. Abbreviations

Table 16. Abbreviations

Acronym	Description
CATV	Community Antenna TeleVision
CW	Continuous Wave
ESD	ElectroStatic Discharge
HVQFN	Heatsink Very thin Quad Flat pack No leads
QAM	Quadrature Amplitude Modulation
QPSK	Quadrature Phase-Shift Keying
SMA	SubMiniature version A
SMD	Surface-Mounted Device
Tx	Transmission
VoIP	Voice over Internet Protocol

17. Revision history

Table 17. Revision history

Document ID	Release date	Data sheet status	Change notice	Supersedes
BGA3031 v.2	20140226	Product data sheet	-	BGA3031 v.1
Modifications	<ul style="list-style-type: none"> • Section 1 on page 1: section updated • Section 2 on page 1: section updated • Section 3 on page 2: application added • Table 2 on page 2: table added • Table 13 on page 10: table added • Section 13.2 on page 12: several figures added 			
BGA3031 v.1	20130815	Product data sheet	-	-

18. Legal information

18.1 Data sheet status

Document status ^{[1][2]}	Product status ^[3]	Definition
Objective [short] data sheet	Development	This document contains data from the objective specification for product development.
Preliminary [short] data sheet	Qualification	This document contains data from the preliminary specification.
Product [short] data sheet	Production	This document contains the product specification.

[1] Please consult the most recently issued document before initiating or completing a design.

[2] The term 'short data sheet' is explained in section "Definitions".

[3] The product status of device(s) described in this document may have changed since this document was published and may differ in case of multiple devices. The latest product status information is available on the Internet at URL <http://www.nxp.com>.

18.2 Definitions

Draft — The document is a draft version only. The content is still under internal review and subject to formal approval, which may result in modifications or additions. NXP Semiconductors does not give any representations or warranties as to the accuracy or completeness of information included herein and shall have no liability for the consequences of use of such information.

Short data sheet — A short data sheet is an extract from a full data sheet with the same product type number(s) and title. A short data sheet is intended for quick reference only and should not be relied upon to contain detailed and full information. For detailed and full information see the relevant full data sheet, which is available on request via the local NXP Semiconductors sales office. In case of any inconsistency or conflict with the short data sheet, the full data sheet shall prevail.

Product specification — The information and data provided in a Product data sheet shall define the specification of the product as agreed between NXP Semiconductors and its customer, unless NXP Semiconductors and customer have explicitly agreed otherwise in writing. In no event however, shall an agreement be valid in which the NXP Semiconductors product is deemed to offer functions and qualities beyond those described in the Product data sheet.

18.3 Disclaimers

Limited warranty and liability — Information in this document is believed to be accurate and reliable. However, NXP Semiconductors does not give any representations or warranties, expressed or implied, as to the accuracy or completeness of such information and shall have no liability for the consequences of use of such information. NXP Semiconductors takes no responsibility for the content in this document if provided by an information source outside of NXP Semiconductors.

In no event shall NXP Semiconductors be liable for any indirect, incidental, punitive, special or consequential damages (including - without limitation - lost profits, lost savings, business interruption, costs related to the removal or replacement of any products or rework charges) whether or not such damages are based on tort (including negligence), warranty, breach of contract or any other legal theory.

Notwithstanding any damages that customer might incur for any reason whatsoever, NXP Semiconductors' aggregate and cumulative liability towards customer for the products described herein shall be limited in accordance with the *Terms and conditions of commercial sale* of NXP Semiconductors.

Right to make changes — NXP Semiconductors reserves the right to make changes to information published in this document, including without limitation specifications and product descriptions, at any time and without notice. This document supersedes and replaces all information supplied prior to the publication hereof.

Suitability for use — NXP Semiconductors products are not designed, authorized or warranted to be suitable for use in life support, life-critical or safety-critical systems or equipment, nor in applications where failure or malfunction of an NXP Semiconductors product can reasonably be expected to result in personal injury, death or severe property or environmental damage. NXP Semiconductors and its suppliers accept no liability for inclusion and/or use of NXP Semiconductors products in such equipment or applications and therefore such inclusion and/or use is at the customer's own risk.

Applications — Applications that are described herein for any of these products are for illustrative purposes only. NXP Semiconductors makes no representation or warranty that such applications will be suitable for the specified use without further testing or modification.

Customers are responsible for the design and operation of their applications and products using NXP Semiconductors products, and NXP Semiconductors accepts no liability for any assistance with applications or customer product design. It is customer's sole responsibility to determine whether the NXP Semiconductors product is suitable and fit for the customer's applications and products planned, as well as for the planned application and use of customer's third party customer(s). Customers should provide appropriate design and operating safeguards to minimize the risks associated with their applications and products.

NXP Semiconductors does not accept any liability related to any default, damage, costs or problem which is based on any weakness or default in the customer's applications or products, or the application or use by customer's third party customer(s). Customer is responsible for doing all necessary testing for the customer's applications and products using NXP Semiconductors products in order to avoid a default of the applications and the products or of the application or use by customer's third party customer(s). NXP does not accept any liability in this respect.

Limiting values — Stress above one or more limiting values (as defined in the Absolute Maximum Ratings System of IEC 60134) will cause permanent damage to the device. Limiting values are stress ratings only and (proper) operation of the device at these or any other conditions above those given in the Recommended operating conditions section (if present) or the Characteristics sections of this document is not warranted. Constant or repeated exposure to limiting values will permanently and irreversibly affect the quality and reliability of the device.

Terms and conditions of commercial sale — NXP Semiconductors products are sold subject to the general terms and conditions of commercial sale, as published at <http://www.nxp.com/profile/terms>, unless otherwise agreed in a valid written individual agreement. In case an individual agreement is concluded only the terms and conditions of the respective agreement shall apply. NXP Semiconductors hereby expressly objects to applying the customer's general terms and conditions with regard to the purchase of NXP Semiconductors products by customer.

No offer to sell or license — Nothing in this document may be interpreted or construed as an offer to sell products that is open for acceptance or the grant, conveyance or implication of any license under any copyrights, patents or other industrial or intellectual property rights.

Export control — This document as well as the item(s) described herein may be subject to export control regulations. Export might require a prior authorization from competent authorities.

Quick reference data — The Quick reference data is an extract of the product data given in the Limiting values and Characteristics sections of this document, and as such is not complete, exhaustive or legally binding.

Non-automotive qualified products — Unless this data sheet expressly states that this specific NXP Semiconductors product is automotive qualified, the product is not suitable for automotive use. It is neither qualified nor tested in accordance with automotive testing or application requirements. NXP Semiconductors accepts no liability for inclusion and/or use of non-automotive qualified products in automotive equipment or applications.

In the event that customer uses the product for design-in and use in automotive applications to automotive specifications and standards, customer (a) shall use the product without NXP Semiconductors' warranty of the

product for such automotive applications, use and specifications, and (b) whenever customer uses the product for automotive applications beyond NXP Semiconductors' specifications such use shall be solely at customer's own risk, and (c) customer fully indemnifies NXP Semiconductors for any liability, damages or failed product claims resulting from customer design and use of the product for automotive applications beyond NXP Semiconductors' standard warranty and NXP Semiconductors' product specifications.

Translations — A non-English (translated) version of a document is for reference only. The English version shall prevail in case of any discrepancy between the translated and English versions.

18.4 Trademarks

Notice: All referenced brands, product names, service names and trademarks are the property of their respective owners.

19. Contact information

For more information, please visit: <http://www.nxp.com>

For sales office addresses, please send an email to: salesaddresses@nxp.com

20. Contents

1 General description 1

2 Features and benefits 1

3 Applications 2

4 Quick reference data 2

5 Ordering information 3

6 Functional diagram 3

7 Pinning information 4

7.1 Pinning 4

7.2 Pin description 4

8 Functional description 5

8.1 Logic programming 5

8.2 Register settings 6

8.2.1 Register address 6

8.2.2 Gain/attenuator setting 6

8.2.3 Output stage current setting 6

8.3 Tx enable / Tx disable 7

9 Limiting values 7

10 Thermal characteristics 8

11 Static characteristics 8

12 Dynamic characteristics 9

13 Application information 11

13.1 External components 11

13.2 Graphs 12

14 Package outline 19

15 Handling information 20

15.1 Moisture sensitivity 20

16 Abbreviations 20

17 Revision history 20

18 Legal information 21

18.1 Data sheet status 21

18.2 Definitions 21

18.3 Disclaimers 21

18.4 Trademarks 22

19 Contact information 22

20 Contents 23

Please be aware that important notices concerning this document and the product(s) described herein, have been included in section 'Legal information'.