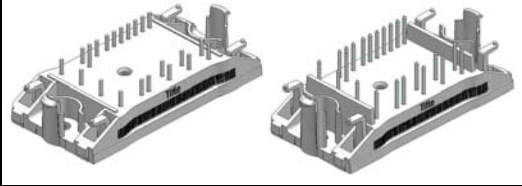
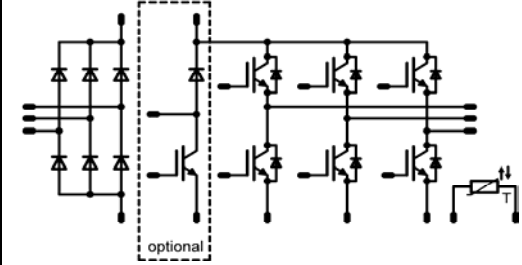

flowPIM0 3rd Gen	1200V/15A
<div style="border: 1px solid black; padding: 5px; margin-bottom: 5px;"> <p style="text-align: center; background-color: #000080; color: white; margin: 0;">Features</p> <ul style="list-style-type: none"> 2 Clips housing in 12 and 17mm height Trench Fieldstop Technology IGBT4 Optional w/o BRC </div> <div style="border: 1px solid black; padding: 5px; margin-bottom: 5px;"> <p style="text-align: center; background-color: #000080; color: white; margin: 0;">Target Applications</p> <ul style="list-style-type: none"> Industrial Drives Embedded Generation </div> <div style="border: 1px solid black; padding: 5px;"> <p style="text-align: center; background-color: #000080; color: white; margin: 0;">Types</p> <ul style="list-style-type: none"> V23990-P840-A48-PM 12mm height V23990-P840-A49-PM 17mm height V23990-P840-C48-PM 12mm height; w/o BRC V23990-P840-C49-PM 17mm height; w/o BRC </div>	<div style="border: 1px solid black; padding: 5px; margin-bottom: 5px;"> <p style="text-align: center; background-color: #000080; color: white; margin: 0;">flow0 Housing</p>  </div> <div style="border: 1px solid black; padding: 5px;"> <p style="text-align: center; background-color: #000080; color: white; margin: 0;">Schematics</p>  </div>

Maximum Ratings

$T_j=25^{\circ}\text{C}$, unless otherwise specified

Parameter	Symbol	Condition	Value	Unit
Input Rectifier Diode				
Repetitive peak reverse voltage	V_{RRM}		1600	V
Forward current per diode	I_{FAV}	DC current $T_h=80^{\circ}\text{C}$ $T_c=80^{\circ}\text{C}$	28	A
Surge forward current	I_{FSM}	$t_p=10\text{ms}$	220	A
I2t-value	I^2t		240	A2s
Power dissipation per Diode	P_{tot}	$T_j=T_{jmax}$ $T_h=80^{\circ}\text{C}$ $T_c=80^{\circ}\text{C}$	33	W
Maximum Junction Temperature	T_{jmax}		150	$^{\circ}\text{C}$
Transistor Inverter				
Collector-emitter voltage	V_{CE}		1200	V
DC collector current	I_C	$T_j=T_{jmax}$ $T_h=80^{\circ}\text{C}$ $T_c=80^{\circ}\text{C}$	19	A
Repetitive peak collector current	I_{Cpuls}	t_p limited by T_{jmax}	45	A
Power dissipation per IGBT	P_{tot}	$T_j=T_{jmax}$ $T_h=80^{\circ}\text{C}$ $T_c=80^{\circ}\text{C}$	52	W
Gate-emitter peak voltage	V_{GE}		± 20	V
Short circuit ratings	t_{SC}	$T_j \leq 150^{\circ}\text{C}$	10	μs
	V_{CC}	$V_{GE}=15\text{V}$	800	V
Maximum Junction Temperature	T_{jmax}		175	$^{\circ}\text{C}$

Maximum Ratings

 $T_j=25^{\circ}\text{C}$, unless otherwise specified

Parameter	Symbol	Condition	Value	Unit
Diode Inverter				
Peak Repetitive Reverse Voltage	V_{RRM}		1200	V
DC forward current	I_F	$T_j=T_{jmax}$ $T_n=80^{\circ}\text{C}$ $T_c=80^{\circ}\text{C}$	18	A
Repetitive peak forward current	I_{FRM}	tp limited by T_{jmax}	30	A
Power dissipation per Diode	P_{tot}	$T_j=T_{jmax}$ $T_n=80^{\circ}\text{C}$ $T_c=80^{\circ}\text{C}$	38	W
Maximum Junction Temperature	T_{jmax}		175	$^{\circ}\text{C}$

Transistor BRC

Collector-emitter voltage	V_{CE}		1200	V
DC collector current	I_C	$T_j=T_{jmax}$ $T_n=80^{\circ}\text{C}$ $T_c=80^{\circ}\text{C}$	12	A
Repetitive peak collector current	I_{cpuls}	tp limited by T_{jmax} $T_n=80^{\circ}\text{C}$	24	A
Power dissipation per IGBT	P_{tot}	$T_j=T_{jmax}$ $T_n=80^{\circ}\text{C}$ $T_c=80^{\circ}\text{C}$	40	W
Gate-emitter peak voltage	V_{GE}		± 20	V
Short circuit ratings	t_{SC}	$T_j \leq 150^{\circ}\text{C}$	10	μs
	V_{CC}	$V_{GE}=15\text{V}$	800	V
Maximum Junction Temperature	T_{jmax}		175	$^{\circ}\text{C}$

Diode BRC

Peak Repetitive Reverse Voltage	V_{RRM}		1200	V
DC forward current	I_F	$T_j=T_{jmax}$ $T_n=80^{\circ}\text{C}$ $T_c=80^{\circ}\text{C}$	10	A
Repetitive peak forward current	I_{FRM}	tp limited by T_{jmax} $T_n=80^{\circ}\text{C}$	15	A
Power dissipation per Diode	P_{tot}	$T_j=T_{jmax}$ $T_n=80^{\circ}\text{C}$ $T_c=80^{\circ}\text{C}$	22	W
Maximum Junction Temperature	T_{jmax}		150	$^{\circ}\text{C}$

Thermal properties

Storage temperature	T_{stg}		-40...+125	$^{\circ}\text{C}$
Operation temperature	T_{jop}		-40...+150	$^{\circ}\text{C}$

Insulation properties

Insulation voltage	V_{is}	$t=2\text{s}$	DC voltage	4000	V
Creepage distance				min 12,7	mm
Clearance				min 12,7	mm

Characteristic Values

Parameter	Symbol	Conditions					Value			Unit
		$V_{GE}(V)$ or $V_{GS}(V)$	$V_c(V)$ or $V_{CE}(V)$ or $V_{DS}(V)$	$I_c(A)$ or $I_e(A)$ or $I_b(A)$	$T(^{\circ}C)$	Min	Typ	Max		
Input Rectifier Diode										
Forward voltage	V_F				30	$T_J=25^{\circ}C$ $T_J=125^{\circ}C$	1	1,22 1,19	1,9	V
Threshold voltage (for power loss calc. only)	V_{td}				30	$T_J=25^{\circ}C$ $T_J=125^{\circ}C$		0,93 0,81		V
Slope resistance (for power loss calc. only)	r_t					$T_J=25^{\circ}C$ $T_J=125^{\circ}C$		0,010 0,013		Ω
Reverse current	I_r			1600		$T_J=25^{\circ}C$ $T_J=150^{\circ}C$			0,1	mA
Thermal resistance chip to heatsink per chip	$R_{th,JH}$	Thermal grease thickness \leq 50 μ m $\lambda = 1$ W/mK						2,16		K/W
Transistor Inverter										
Gate emitter threshold voltage	$V_{GE(th)}$	VCE=VGE			0,0005	$T_J=25^{\circ}C$ $T_J=125^{\circ}C$	5	5,8	6,5	V
Collector-emitter saturation voltage	$V_{CE(sat)}$				15	$T_J=25^{\circ}C$ $T_J=125^{\circ}C$		1,94 2,26		V
Collector-emitter cut-off current incl. Diode	I_{CES}		0	1200		$T_J=25^{\circ}C$ $T_J=125^{\circ}C$			0,01	mA
Gate-emitter leakage current	I_{GES}		20	0		$T_J=25^{\circ}C$ $T_J=125^{\circ}C$			200	nA
Integrated Gate resistor	R_{gint}							none		Ω
Turn-on delay time	$t_{d(on)}$	Rgon=16 Ohm Rgoff=16 Ohm	\pm 15	600	15	$T_J=25^{\circ}C$ $T_J=125^{\circ}C$		60		ns
Rise time	t_r					$T_J=25^{\circ}C$ $T_J=125^{\circ}C$		19		ns
Turn-off delay time	$t_{d(off)}$					$T_J=25^{\circ}C$ $T_J=125^{\circ}C$		239		ns
Fall time	t_f					$T_J=25^{\circ}C$ $T_J=125^{\circ}C$		106		ns
Turn-on energy loss per pulse	E_{on}					$T_J=25^{\circ}C$ $T_J=125^{\circ}C$		1,25		mWs
Turn-off energy loss per pulse	E_{off}					$T_J=25^{\circ}C$ $T_J=125^{\circ}C$		1,24		mWs
Input capacitance	C_{ies}	f=1MHz	0	25		$T_J=25^{\circ}C$		1000		pF
Output capacitance	C_{oss}							100		pF
Reverse transfer capacitance	C_{rss}							56		pF
Gate charge	Q_{Gate}	Vcc=960V	\pm 15		15	$T_J=25^{\circ}C$		93		nC
Thermal resistance chip to heatsink per chip	$R_{th,JH}$	Thermal grease thickness \leq 50 μ m $\lambda = 1$ W/mK						1,83		K/W
Diode Inverter										
Diode forward voltage	V_F				10	$T_J=25^{\circ}C$ $T_J=125^{\circ}C$	1,35	1,90 1,91	2,35	V
Reverse leakage current	I_{rm}			1200		$T_J=25^{\circ}C$ $T_J=125^{\circ}C$		2,7		mA
Peak reverse recovery current	I_{RRM}	Rgon=16 Ohm	\pm 15	600	15	$T_J=25^{\circ}C$ $T_J=125^{\circ}C$		16		A
Reverse recovery time	t_{rr}					$T_J=25^{\circ}C$ $T_J=125^{\circ}C$		433		ns
Reverse recovered charge	Q_{rr}					$T_J=25^{\circ}C$ $T_J=125^{\circ}C$		2,75		μ C
Peak rate of fall of recovery current	$di(rec)max/dt$					$T_J=25^{\circ}C$ $T_J=125^{\circ}C$		109		A/ms
Reverse recovered energy	E_{rec}					$T_J=25^{\circ}C$ $T_J=125^{\circ}C$		1,16		mWs
Thermal resistance chip to heatsink per chip	$R_{th,JH}$					Thermal grease thickness \leq 50 μ m $\lambda = 1$ W/mK				

Characteristic Values

Parameter	Symbol	Conditions					Value			Unit
		$V_{GE}(V)$ or $V_{GS}(V)$	$V_A(V)$ or $V_{CE}(V)$ or $V_{DS}(V)$	$I_C(A)$ or $I_F(A)$ or $I_B(A)$	$T(°C)$	Min	Typ	Max		
Transistor BRC										
Gate emitter threshold voltage	$V_{GE(th)}$	VCE=VGE			0,0003	T _J =25°C T _J =125°C	5	5,8	6,5	V
Collector-emitter saturation voltage	$V_{CE(sat)}$				8	T _J =25°C T _J =125°C	1,6	1,87 2,22	2,1	V
Collector-emitter cut-off	I_{CES}		0	1200		T _J =25°C T _J =125°C			0,05	mA
Gate-emitter leakage current	I_{GES}		20	0		T _J =25°C T _J =125°C			200	nA
Integrated Gate resistor	R_{gint}							none		Ω
Turn-on delay time	$t_{d(on)}$	R _{gon} =32Ohm R _{goff} =32Ohm	15	600	8	T _J =25°C T _J =125°C		72		ns
Rise time	t_r					T _J =25°C T _J =125°C		24		ns
Turn-off delay time	$t_{d(off)}$					T _J =25°C T _J =125°C		228		ns
Fall time	t_f					T _J =25°C T _J =125°C		104		ns
Turn-on energy loss per pulse	E_{on}					T _J =25°C T _J =125°C		0,71		mWs
Turn-off energy loss per pulse	E_{off}					T _J =25°C T _J =125°C		0,62		mWs
Input capacitance	C_{iES}									
Output capacitance	C_{oSS}	f=1MHz	0	25		T _J =25°C		50		pF
Reverse transfer capacitance	C_{rSS}							30		pF
Gate charge	Q_{Gate}	V _{CC} =960V	±15		8	T _J =25°C		50		nC
Thermal resistance chip to heatsink per chip	R_{thJH}	Thermal grease thickness≤50um λ = 1 W/mK						2,36		K/W
Diode BRC										
Diode forward voltage	V_F				7,5	T _J =25°C T _J =125°C	0,8	1,67 1,61	2,2	V
Reverse leakage current	I_r			1200		T _J =25°C T _J =125°C			250	mA
Peak reverse recovery current	I_{RRM}	R _{gon} =32Ohm	15	600	8	T _J =25°C T _J =125°C		10		A
Reverse recovery time	t_{rr}					T _J =25°C T _J =125°C		427		ns
Reverse recovered charge	Q_{rr}					T _J =25°C T _J =125°C		1,64		mC
Peak rate of fall of recovery current	$di(rec)max/dt$					T _J =25°C T _J =125°C		73		A/ms
Reverse recovery energy	E_{rec}					T _J =25°C T _J =125°C		0,69		mWs
Thermal resistance chip to heatsink per chip	R_{thJH}					Thermal grease thickness≤50um λ = 1 W/mK				
Thermistor										
Rated resistance	R_{25}	Tol. ±13%				T _J =25°C	19,1	22	24,9	kΩ
	R_{100}	Tol. ±5%				T _J =100°C	1411	1486	1560	
Power dissipation given Epcos-Typ	P					T _J =25°C		210		mW
B-value	$B_{(25/100)}$	Tol. ±3%				T _J =25°C		4000		K

Output Inverter

Figure 1 Output inverter IGBT

Typical output characteristics

$I_C = f(V_{CE})$

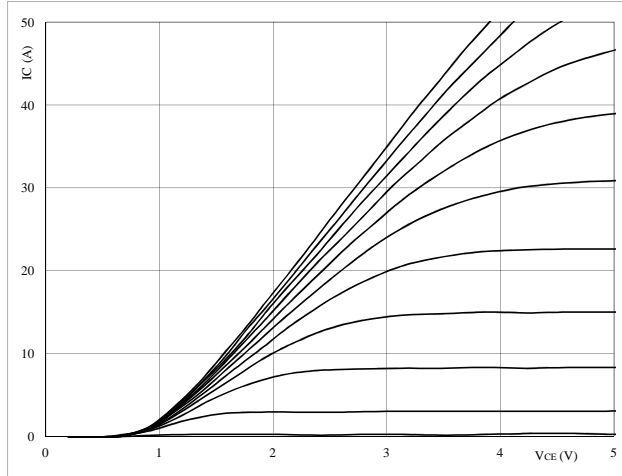

At
 $t_p = 250 \mu s$
 $T_J = 25 \text{ }^\circ C$
 V_{GE} from 7 V to 17 V in steps of 1 V

Figure 2 Output inverter IGBT

Typical output characteristics

$I_C = f(V_{CE})$

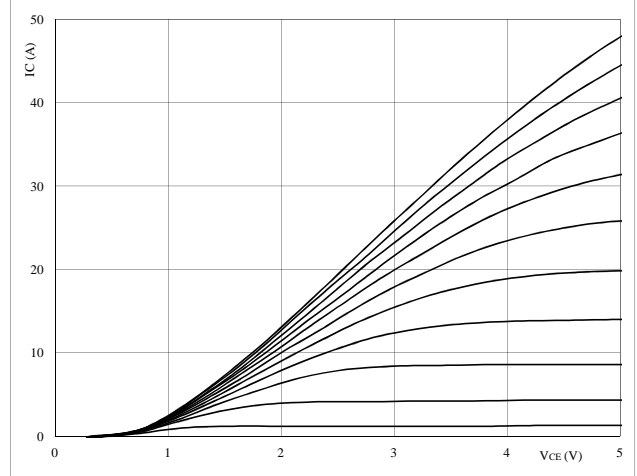

At
 $t_p = 250 \mu s$
 $T_J = 125 \text{ }^\circ C$
 V_{GE} from 7 V to 17 V in steps of 1 V

Figure 3 Output inverter IGBT

Typical transfer characteristics

$I_C = f(V_{GE})$

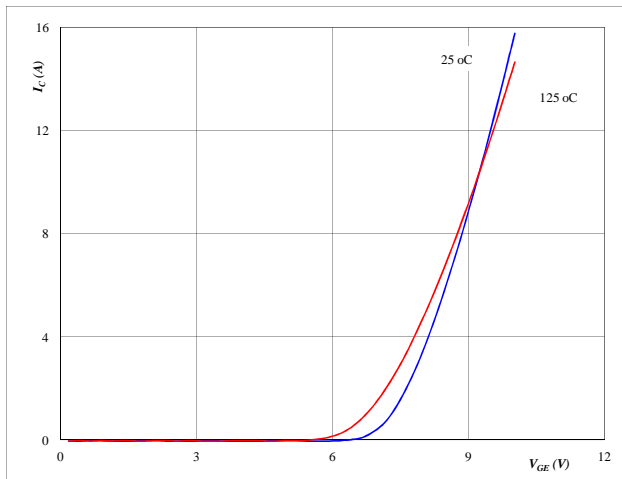

At
 $t_p = 250 \mu s$
 $V_{CE} = 10 V$

Figure 4 Output inverter FRED

Typical diode forward current as a function of forward voltage

$I_F = f(V_F)$

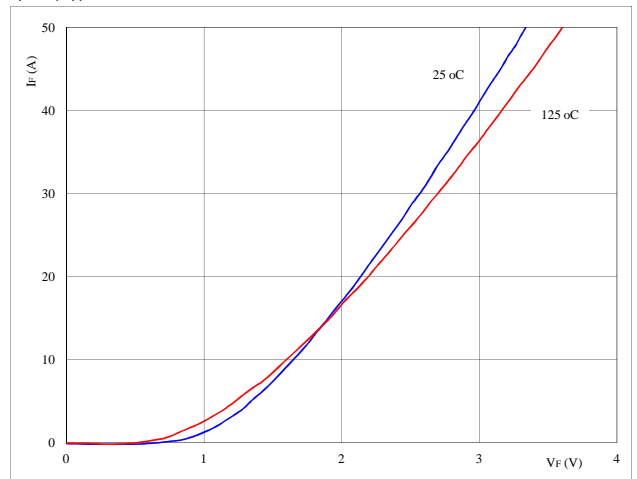

At
 $t_p = 250 \mu s$

Output Inverter

Figure 5 Output inverter IGBT

Typical switching energy losses
as a function of collector current
 $E = f(I_C)$

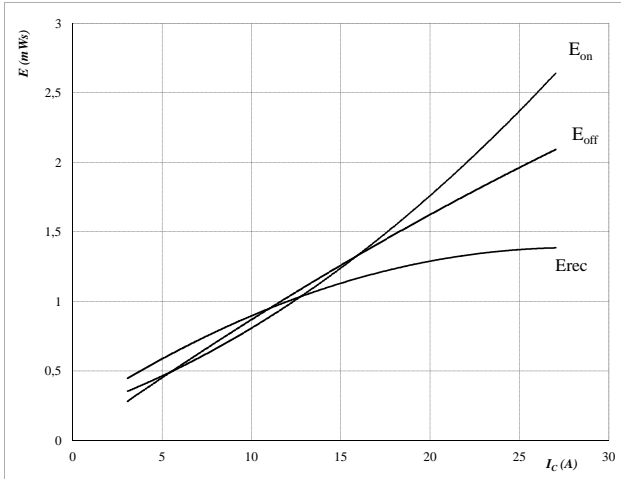

With an inductive load at

$T_J = 125 \text{ } ^\circ\text{C}$
 $V_{CE} = 600 \text{ V}$
 $V_{GE} = \pm 15 \text{ V}$
 $R_{gon} = 16 \text{ } \Omega$
 $R_{goff} = 16 \text{ } \Omega$

Figure 6 Output inverter IGBT

Typical switching energy losses
as a function of gate resistor
 $E = f(R_G)$

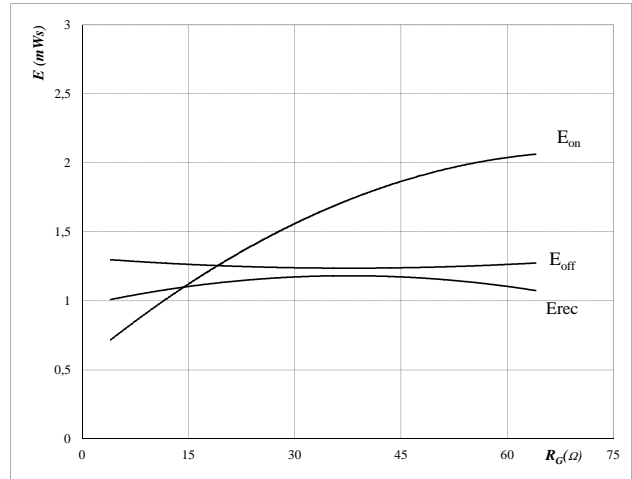

With an inductive load at

$T_J = 125 \text{ } ^\circ\text{C}$
 $V_{CE} = 600 \text{ V}$
 $V_{GE} = \pm 15 \text{ V}$
 $I_C = 15 \text{ A}$

Figure 7 Output inverter IGBT

Typical switching times as a
function of collector current
 $t = f(I_C)$

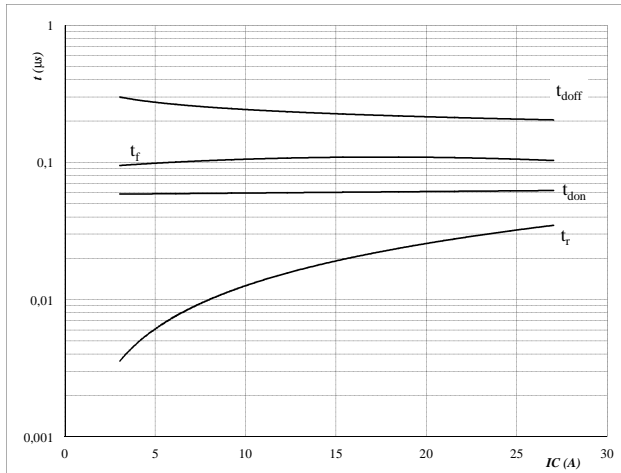

With an inductive load at

$T_J = 125 \text{ } ^\circ\text{C}$
 $V_{CE} = 600 \text{ V}$
 $V_{GE} = \pm 15 \text{ V}$
 $R_{gon} = 16 \text{ } \Omega$
 $R_{goff} = 16 \text{ } \Omega$

Figure 8 Output inverter IGBT

Typical switching times as a
function of gate resistor
 $t = f(R_G)$

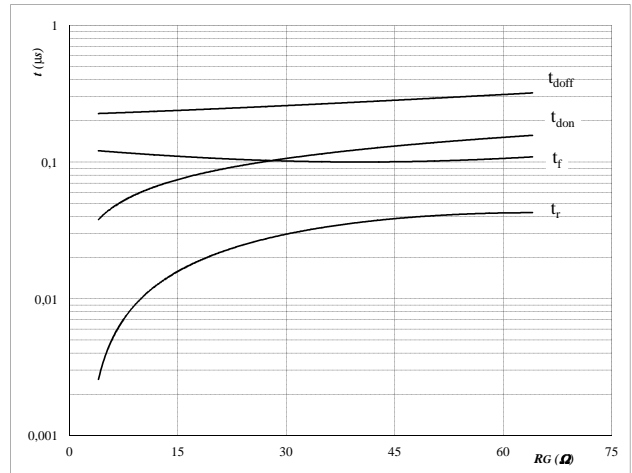

With an inductive load at

$T_J = 125 \text{ } ^\circ\text{C}$
 $V_{CE} = 600 \text{ V}$
 $V_{GE} = \pm 15 \text{ V}$
 $I_C = 15 \text{ A}$

Output Inverter

Figure 9 Output inverter FRED diode

Typical reverse recovery time as a function of IGBT turn on gate resistor

$$t_{rr} = f(R_{gon})$$

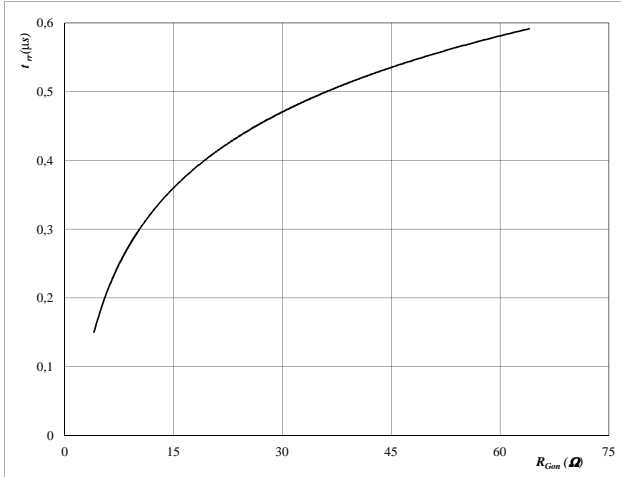

At
 $T_j = 125 \text{ } ^\circ\text{C}$
 $V_R = 600 \text{ V}$
 $I_F = 15 \text{ A}$
 $V_{GE} = \pm 15 \text{ V}$

Figure 10 Output inverter FRED diode

Typical reverse recovery current as a function of IGBT turn on gate resistor

$$I_{RRM} = f(R_{gon})$$

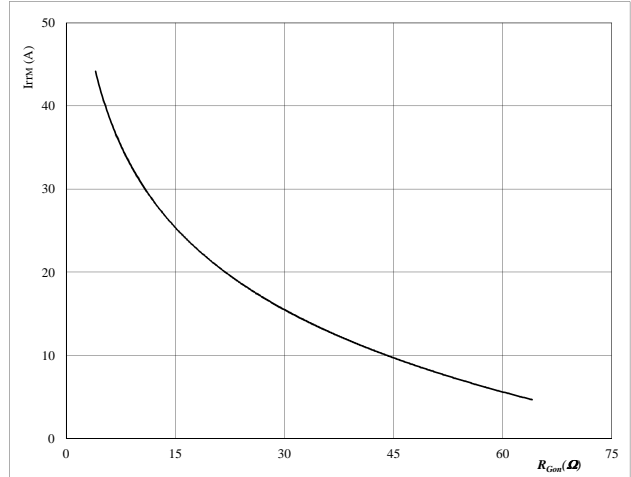

At
 $T_j = 125 \text{ } ^\circ\text{C}$
 $V_R = 600 \text{ V}$
 $I_F = 15 \text{ A}$
 $V_{GE} = \pm 15 \text{ V}$

Figure 11 Output inverter FRED diode

Typical reverse recovery charge as a function of IGBT turn on gate resistor

$$Q_{rr} = f(R_{gon})$$

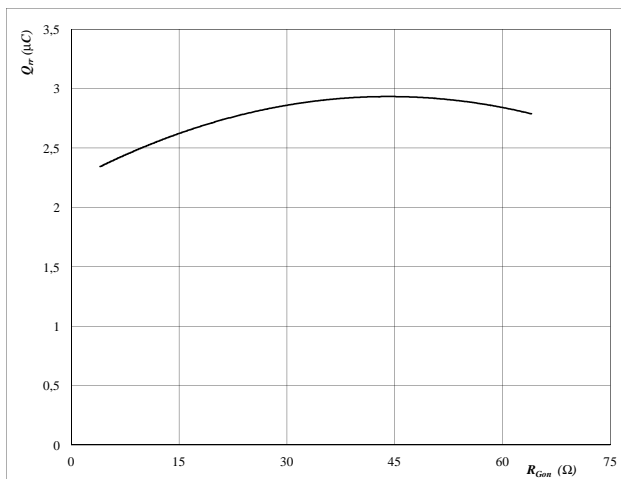

At
 $T_j = 125 \text{ } ^\circ\text{C}$
 $V_R = 600 \text{ V}$
 $I_F = 15 \text{ A}$
 $V_{GE} = \pm 15 \text{ V}$

Figure 12 Output inverter FRED diode

Typical rate of fall of forward and reverse recovery current as a function of IGBT turn on gate resistor

$$dI_0/dt, dI_{rec}/dt = f(R_{gon})$$

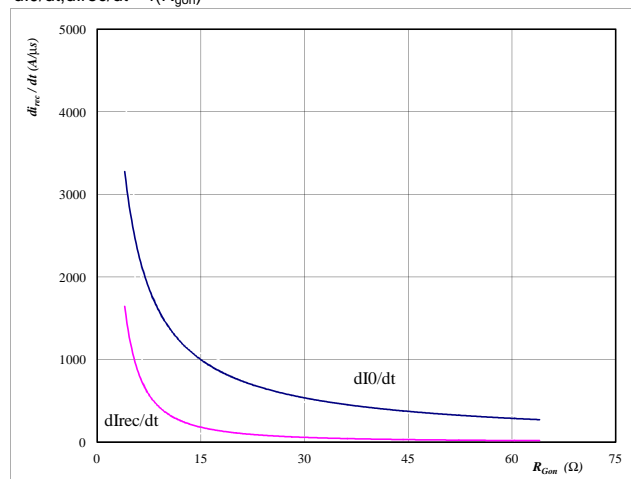

At
 $T_j = 125 \text{ } ^\circ\text{C}$
 $V_R = 600 \text{ V}$
 $I_F = 15 \text{ A}$
 $V_{GE} = \pm 15 \text{ V}$

Output Inverter

Figure 13
IGBT transient thermal impedance
as a function of pulse width

$$Z_{thJH} = f(tp)$$

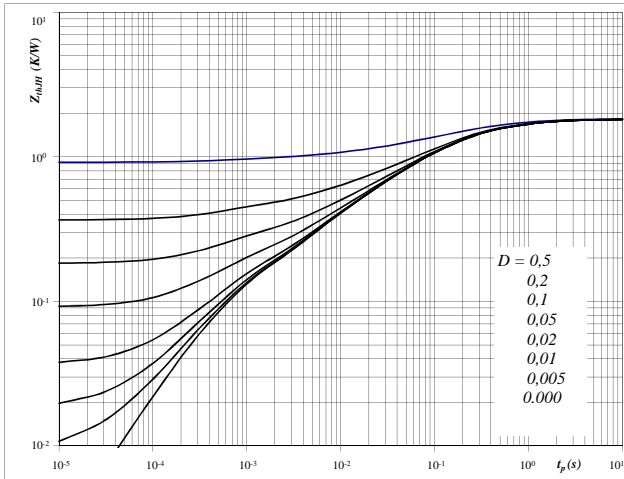

With

$$D = tp / T$$

$$R_{thJH} = 1,83 \quad \text{K/W}$$

IGBT thermal model values

R (C/W)	Tau (s)
0,06	5,6E+00
0,28	8,7E-01
0,77	1,7E-01
0,42	3,4E-02
0,19	6,2E-03
0,10	5,5E-04

Figure 14
FRED transient thermal impedance
as a function of pulse width

$$Z_{thJH} = f(tp)$$

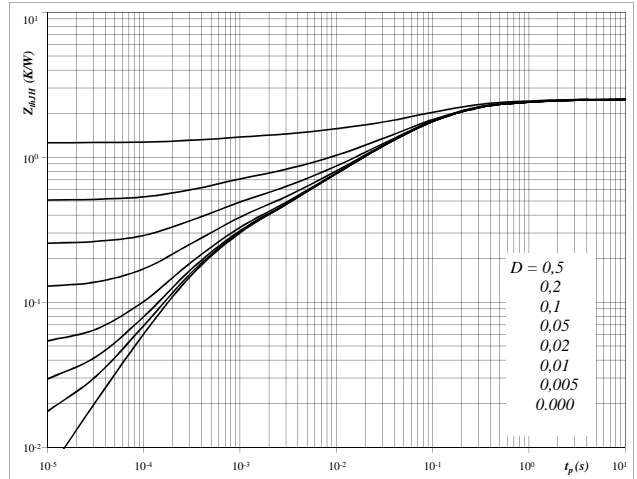

With

$$D = tp / T$$

$$R_{thJH} = 2,52 \quad \text{K/W}$$

FRED thermal model values

R (C/W)	Tau (s)
0,05	9,6E+00
0,26	8,2E-01
1,04	1,2E-01
0,69	2,6E-02
0,27	3,4E-03
0,21	3,8E-04

Output Inverter

Figure 15 Output inverter IGBT

Power dissipation as a function of heatsink temperature

$$P_{tot} = f(T_h)$$

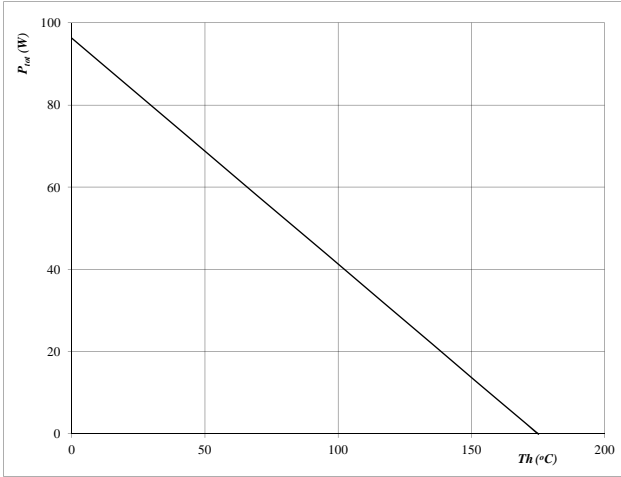

At $T_j = 175$ °C

Figure 16 Output inverter IGBT

Collector current as a function of heatsink temperature

$$I_C = f(T_h)$$

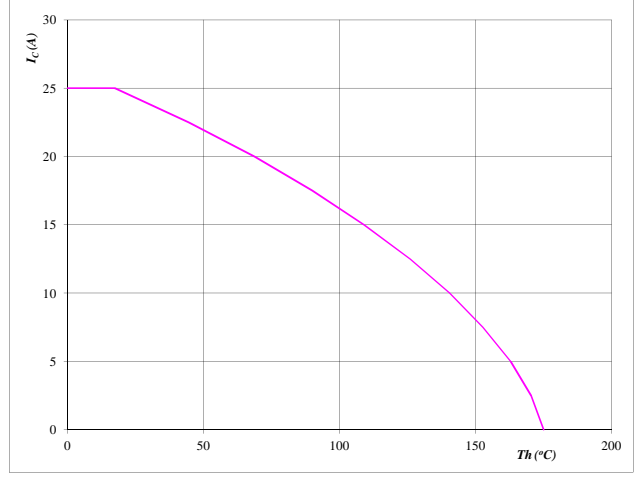

At $T_j = 175$ °C
 $V_{GE} = 15$ V

Figure 17 Output inverter FRED

Power dissipation as a function of heatsink temperature

$$P_{tot} = f(T_h)$$

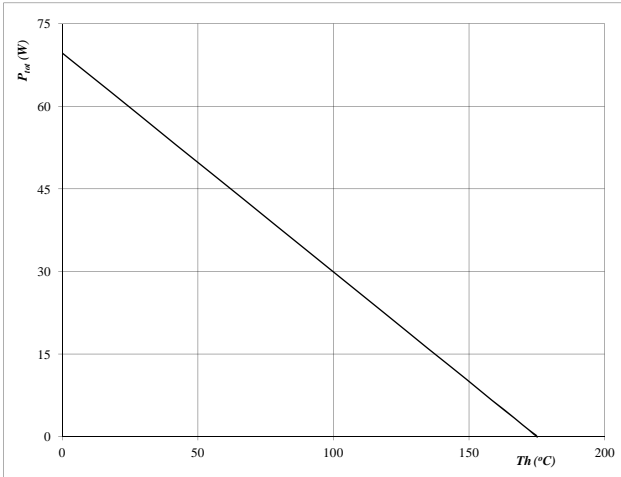

At $T_j = 175$ °C

Figure 18 Output inverter FRED

Forward current as a function of heatsink temperature

$$I_F = f(T_h)$$

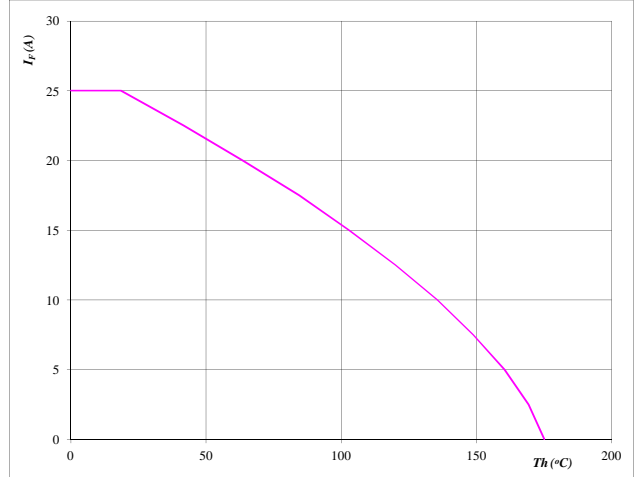

At $T_j = 175$ °C

Brake

Figure 1 Brake IGBT

Typical output characteristics

$$I_C = f(V_{CE})$$

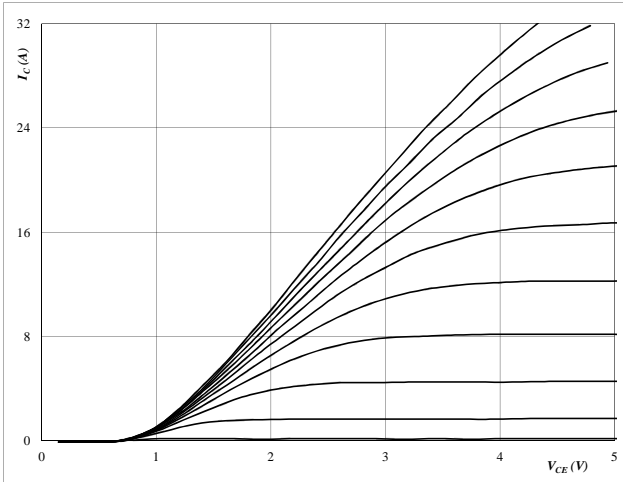

At

$$t_p = 250 \mu s$$

$$T_j = 25 \text{ } ^\circ C$$

VGE from 7 V to 17 V in steps of 1 V

Figure 2 Brake IGBT

Typical output characteristics

$$I_C = f(V_{CE})$$

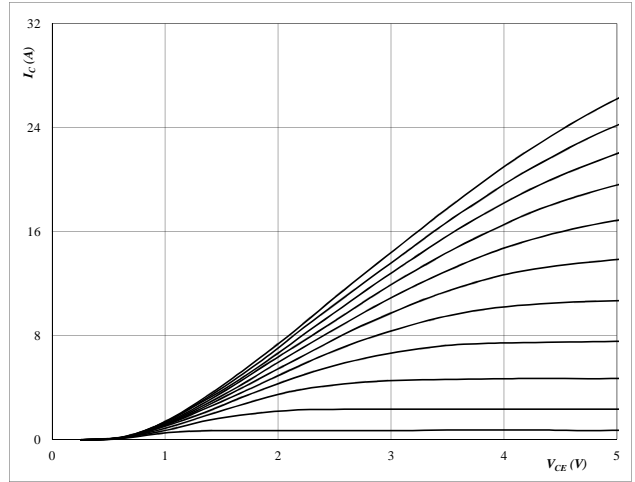

At

$$t_p = 250 \mu s$$

$$T_j = 125 \text{ } ^\circ C$$

VGE from 7 V to 17 V in steps of 1 V

Figure 3 Brake IGBT

Typical transfer characteristics

$$I_C = f(V_{GE})$$

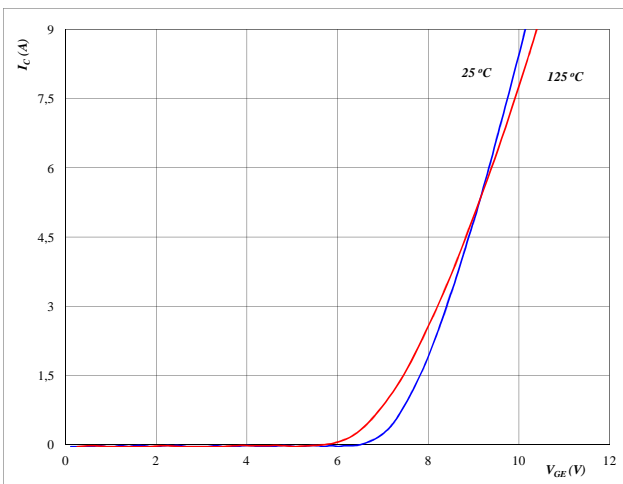

At

$$t_p = 250 \mu s$$

$$V_{CE} = 10 \text{ V}$$

Figure 4 Brake FRED

Typical diode forward current as a function of forward voltage

$$I_F = f(V_F)$$

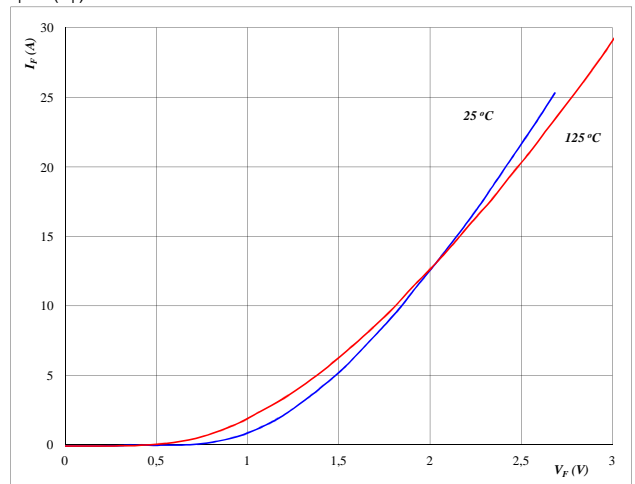

At

$$t_p = 250 \mu s$$

Brake

Figure 5 Brake IGBT

Typical switching energy losses
as a function of collector current

$$E = f(I_C)$$

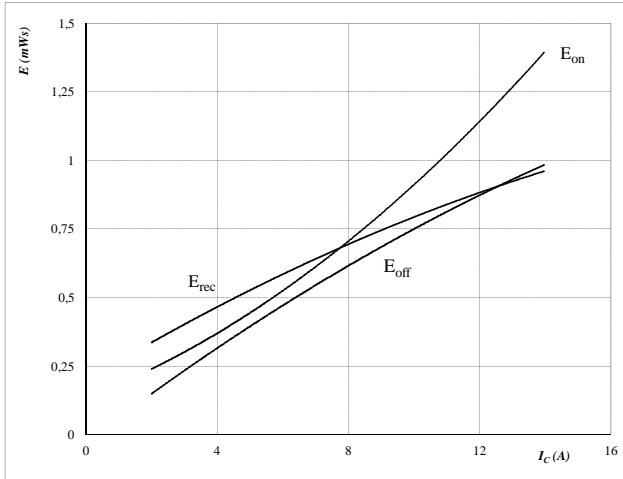

With an inductive load at

$T_j =$	125	°C
$V_{CE} =$	600	V
$V_{GE} =$	±15	V
$R_{gon} =$	32	Ω
$R_{goff} =$	32	Ω

Figure 6 Brake IGBT

Typical switching energy losses
as a function of gate resistor

$$E = f(R_G)$$

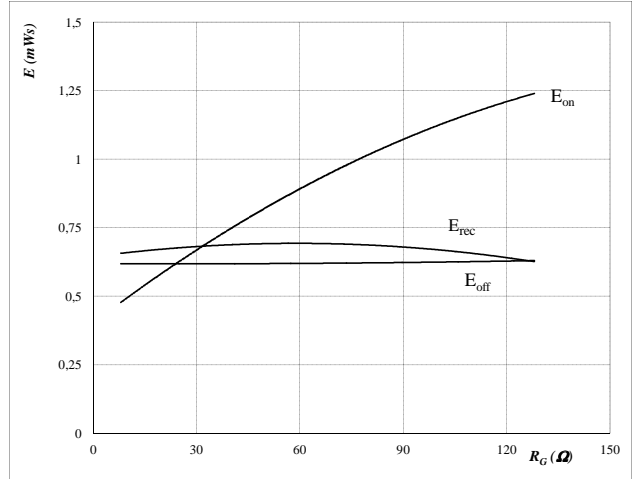

With an inductive load at

$T_j =$	125	°C
$V_{CE} =$	600	V
$V_{GE} =$	±15	V
$I_C =$	8	A

Figure 7 Brake IGBT

Typical switching times as a
function of collector current

$$t = f(I_C)$$

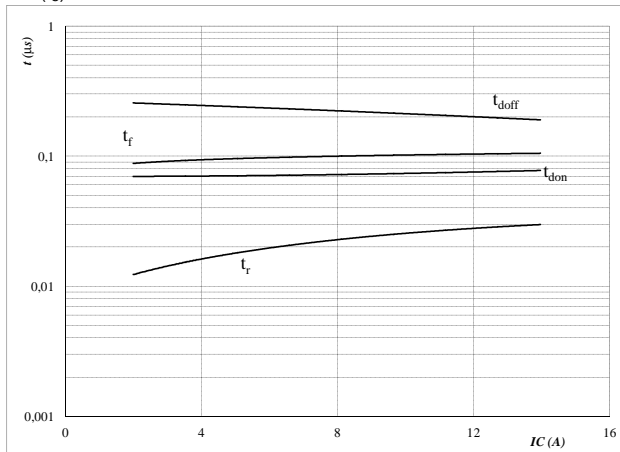

With an inductive load at

$T_j =$	125	°C
$V_{CE} =$	600	V
$V_{GE} =$	±15	V
$R_{gon} =$	32	Ω
$R_{goff} =$	32	Ω

Figure 8 Brake IGBT

Typical switching times as a
function of gate resistor

$$t = f(R_G)$$

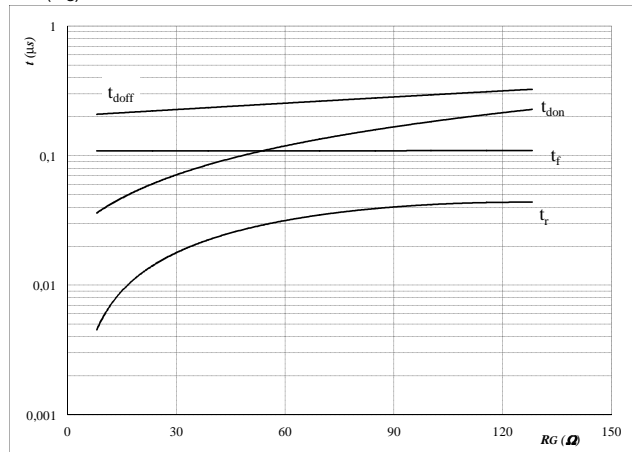

With an inductive load at

$T_j =$	125	°C
$V_{CE} =$	600	V
$V_{GE} =$	±15	V
$I_C =$	8	A

Brake

Figure 9
IGBT transient thermal impedance
as a function of pulse width

$$Z_{thJH} = f(t_p)$$

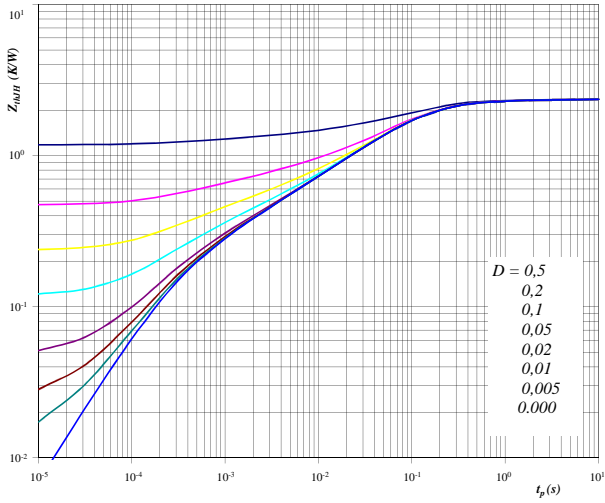

With
 $D = \frac{t_p}{T}$
 $R_{thJH} = 2,36 \text{ K/W}$

Figure 10
FRED transient thermal impedance
as a function of pulse width

$$Z_{thJH} = f(t_p)$$

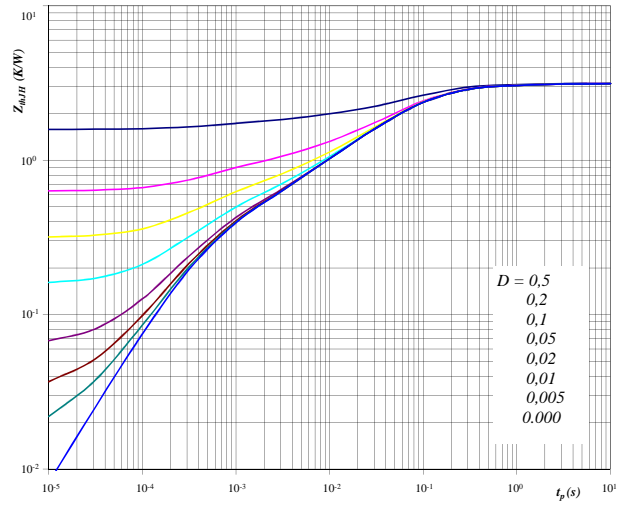

With
 $D = \frac{t_p}{T}$
 $R_{thJH} = 3,15 \text{ K/W}$

Brake

Figure 11 Brake IGBT

Power dissipation as a function of heatsink temperature

$$P_{tot} = f(T_h)$$

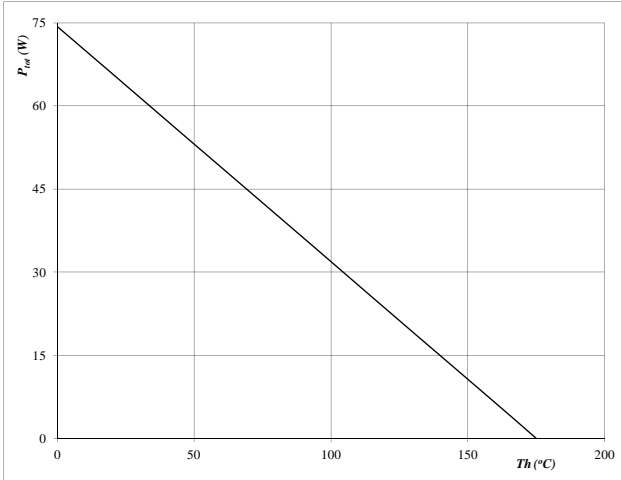

At
T_j = 175 °C

Figure 12 Brake IGBT

Collector current as a function of heatsink temperature

$$I_C = f(T_h)$$

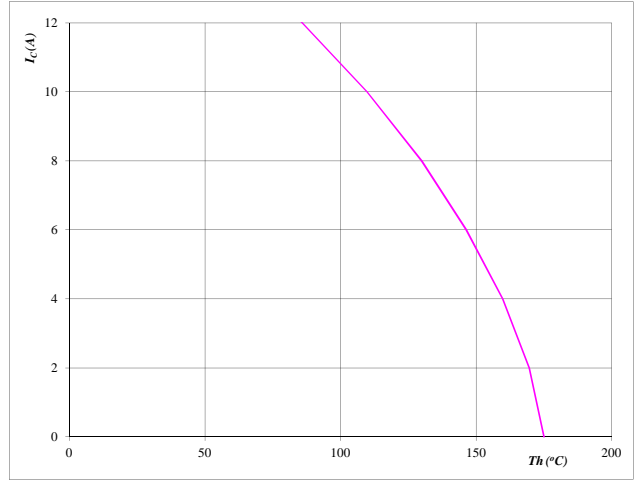

At
T_j = 175 °C
V_{GE} = 15 V

Figure 13 Brake FRED

Power dissipation as a function of heatsink temperature

$$P_{tot} = f(T_h)$$

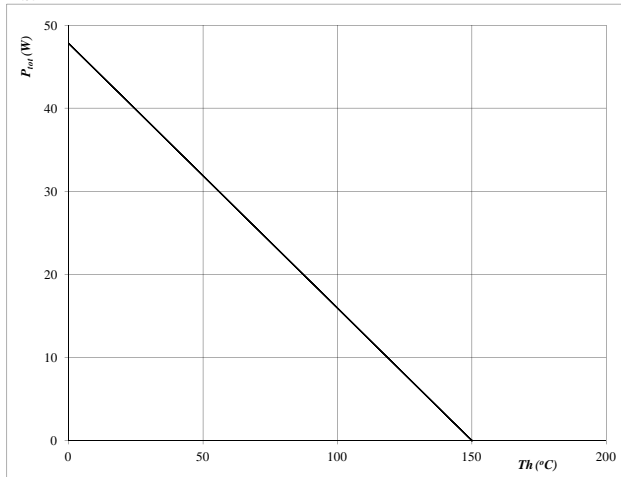

At
T_j = 150 °C

Figure 14 Brake FRED

Forward current as a function of heatsink temperature

$$I_F = f(T_h)$$

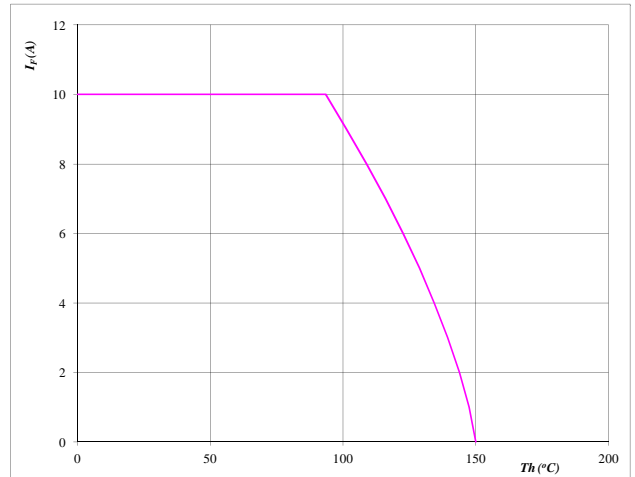

At
T_j = 150 °C

Input Rectifier Bridge

Figure 1 Rectifier diode

Typical diode forward current as a function of forward voltage

$I_F = f(V_F)$

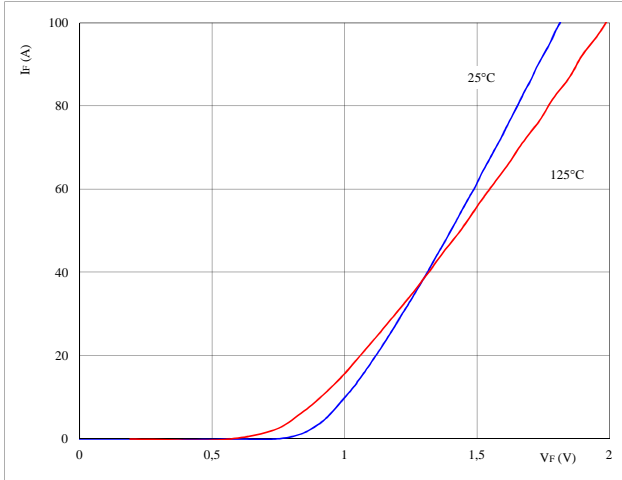

At $t_p = 250 \mu s$

Figure 2 Rectifier diode

Diode transient thermal impedance as a function of pulse width

$Z_{thJC} = f(t_p)$

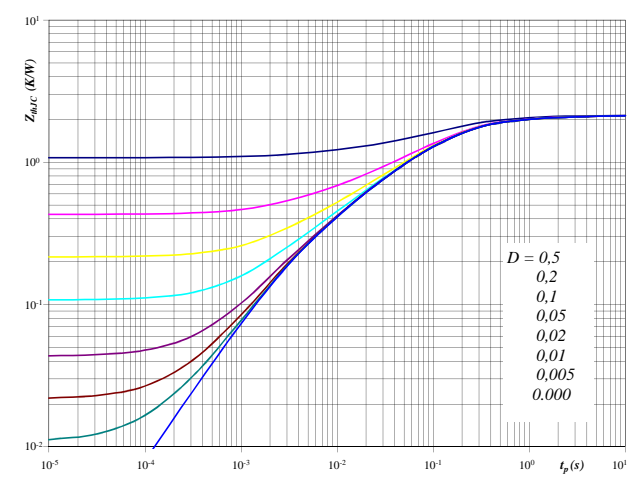

With $D = t_p / T$
 $R_{thJH} = 2,16 \text{ K/W}$

Figure 3 Rectifier diode

Power dissipation as a function of heatsink temperature

$P_{tot} = f(T_h)$

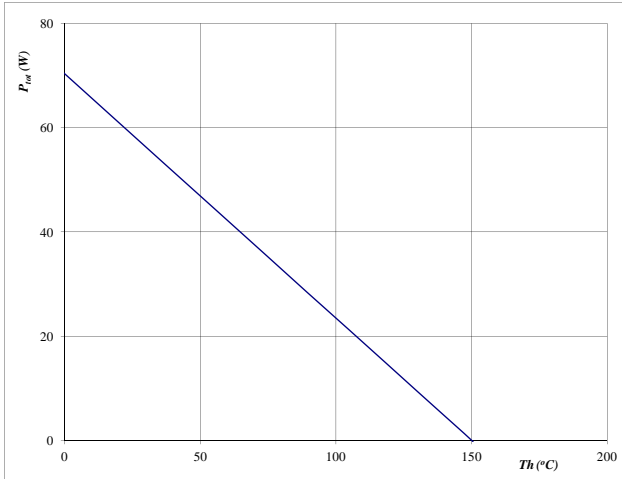

At $T_j = 150 \text{ }^\circ\text{C}$

Figure 4 Rectifier diode

Forward current as a function of heatsink temperature

$I_F = f(T_h)$

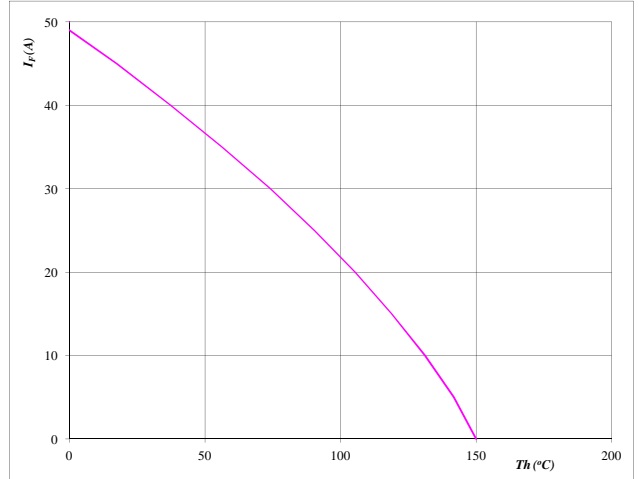

At $T_j = 150 \text{ }^\circ\text{C}$

Thermistor

Figure 1 Thermistor

Typical NTC characteristic
 as a function of temperature

$$R_T = f(T)$$

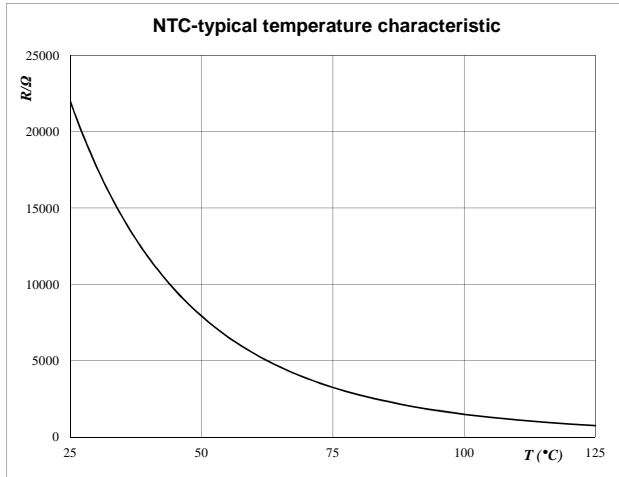

Switching Definitions Output Inverter

General conditions

T_j	=	125 °C
R_{gon}	=	16 Ω
R_{goff}	=	19 Ω

Figure 1 Output inverter IGBT

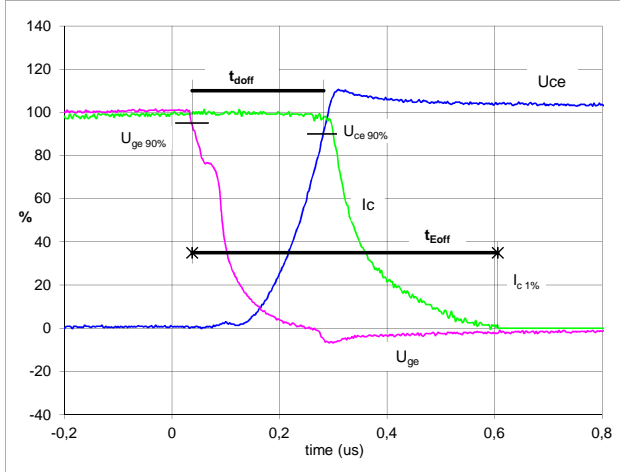
Turn-off Switching Waveforms & definition of t_{doff} , t_{Eoff}
 (t_{Eoff} = integrating time for E_{off})

$V_{GE}(0\%)$	=	-15	V
$V_{GE}(100\%)$	=	15	V
$V_C(100\%)$	=	600	V
$I_C(100\%)$	=	15	A
t_{doff}	=	0,24	μs
t_{Eoff}	=	0,57	μs

Figure 2 Output inverter IGBT

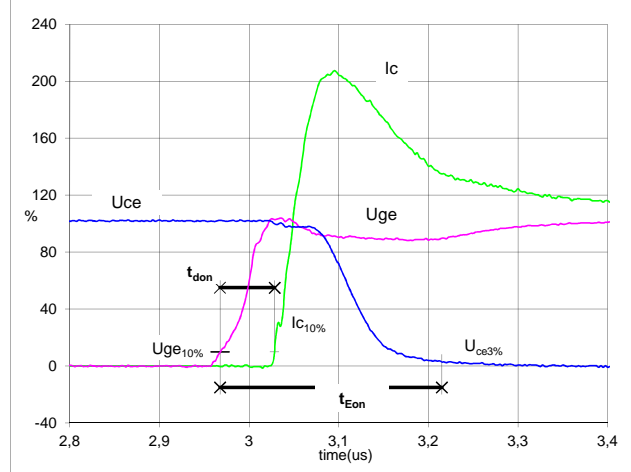
Turn-on Switching Waveforms & definition of t_{don} , t_{Eon}
 (t_{Eon} = integrating time for E_{on})

$V_{GE}(0\%)$	=	-15	V
$V_{GE}(100\%)$	=	15	V
$V_C(100\%)$	=	600	V
$I_C(100\%)$	=	15	A
t_{don}	=	0,06	μs
t_{Eon}	=	0,25	μs

Figure 3 Output inverter IGBT

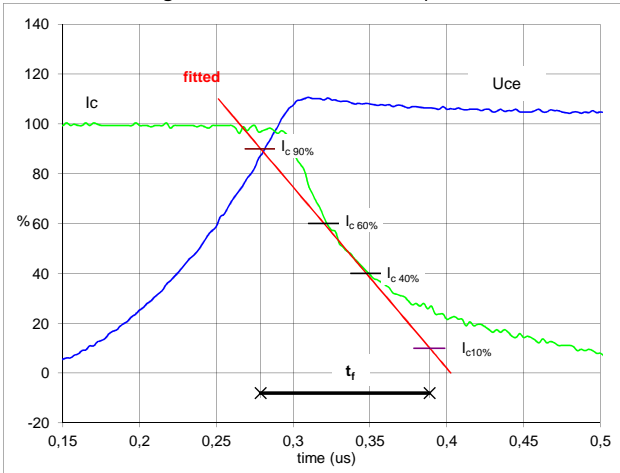
Turn-off Switching Waveforms & definition of t_f

$V_C(100\%)$	=	600	V
$I_C(100\%)$	=	15	A
t_f	=	0,106	μs

Figure 4 Output inverter IGBT

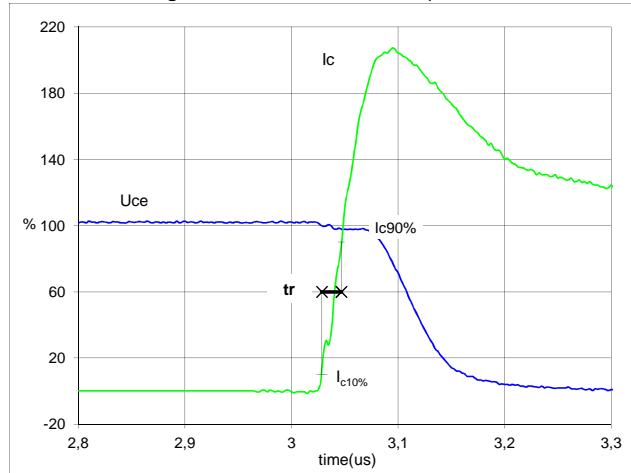
Turn-on Switching Waveforms & definition of t_r

$V_C(100\%)$	=	600	V
$I_C(100\%)$	=	15	A
t_r	=	0,019	μs

Switching Definitions Output Inverter

Figure 5 Output inverter IGBT

Turn-off Switching Waveforms & definition of t_{Eoff}

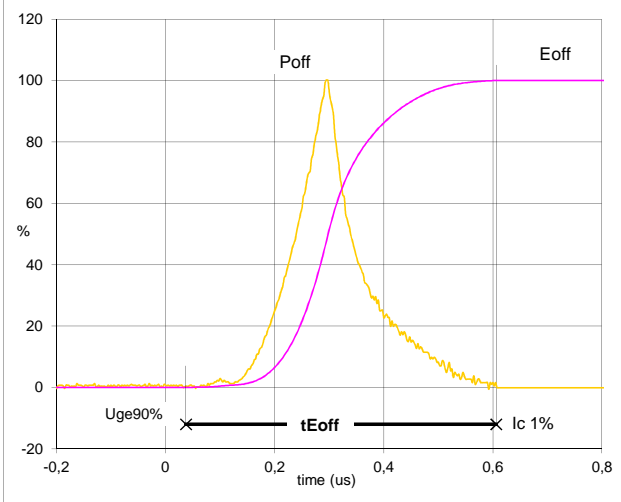

$P_{off}(100\%) = 9,00$ kW
 $E_{off}(100\%) = 1,24$ mJ
 $t_{Eoff} = 0,57$ μ s

Figure 6 Output inverter IGBT

Turn-on Switching Waveforms & definition of t_{Eon}

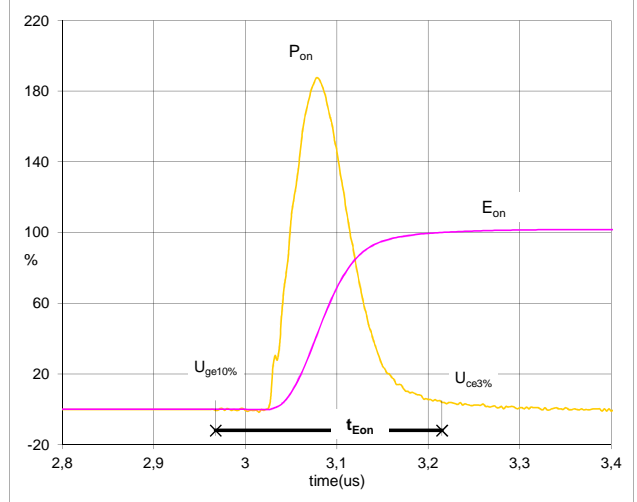

$P_{on}(100\%) = 9,00$ kW
 $E_{on}(100\%) = 1,25$ mJ
 $t_{Eon} = 0,25$ μ s

Figure 7 Output inverter IGBT

Gate voltage vs Gate charge

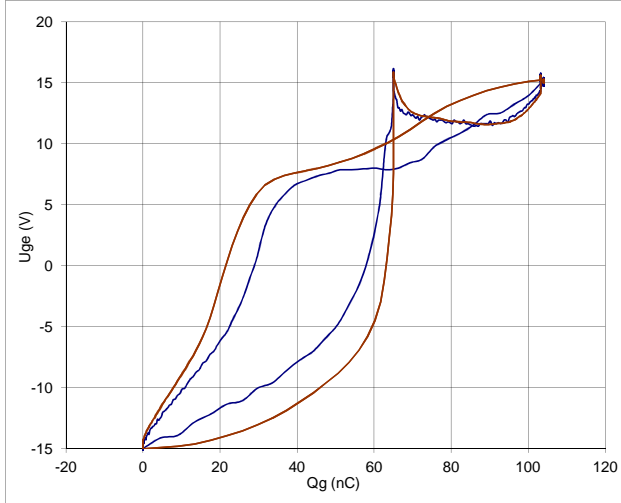

$V_{GEoff} = -15$ V
 $V_{GEon} = 15$ V
 $V_C(100\%) = 600$ V
 $I_C(100\%) = 15$ A
 $Q_g = 104,04$ nC

Figure 8 Output inverter FRED

Turn-off Switching Waveforms & definition of t_{rr}

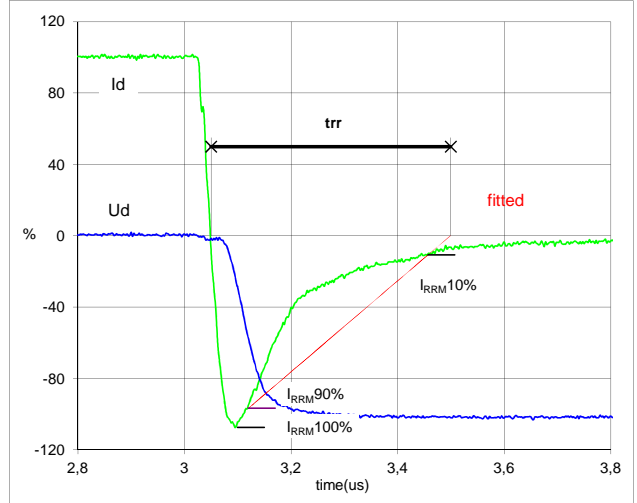

$V_d(100\%) = 600$ V
 $I_d(100\%) = 15$ A
 $I_{RRM}(100\%) = -16$ A
 $t_{rr} = 0,43$ μ s

Switching Definitions Output Inverter

Figure 9 Output inverter FRED

Turn-on Switching Waveforms & definition of t_{Qrr}
(t_{Qrr} = integrating time for Q_{rr})

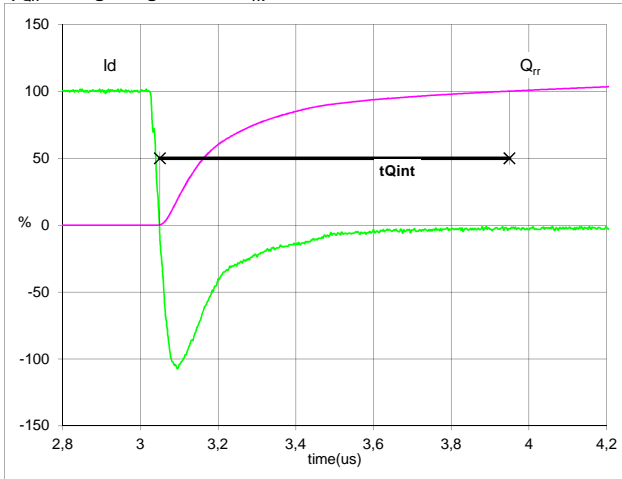

I_d (100%) = 15 A
 Q_{rr} (100%) = 2,75 μ C
 t_{Qint} = 0,90 μ s

Figure 10 Output inverter FRED

Turn-on Switching Waveforms & definition of t_{Erec}
(t_{Erec} = integrating time for E_{rec})

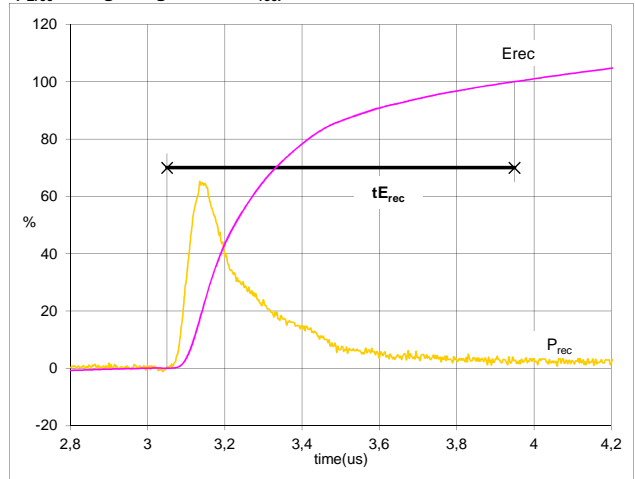

P_{rec} (100%) = 9,00 kW
 E_{rec} (100%) = 1,157 mJ
 t_{Erec} = 0,90 μ s

Package Outline and Pinout

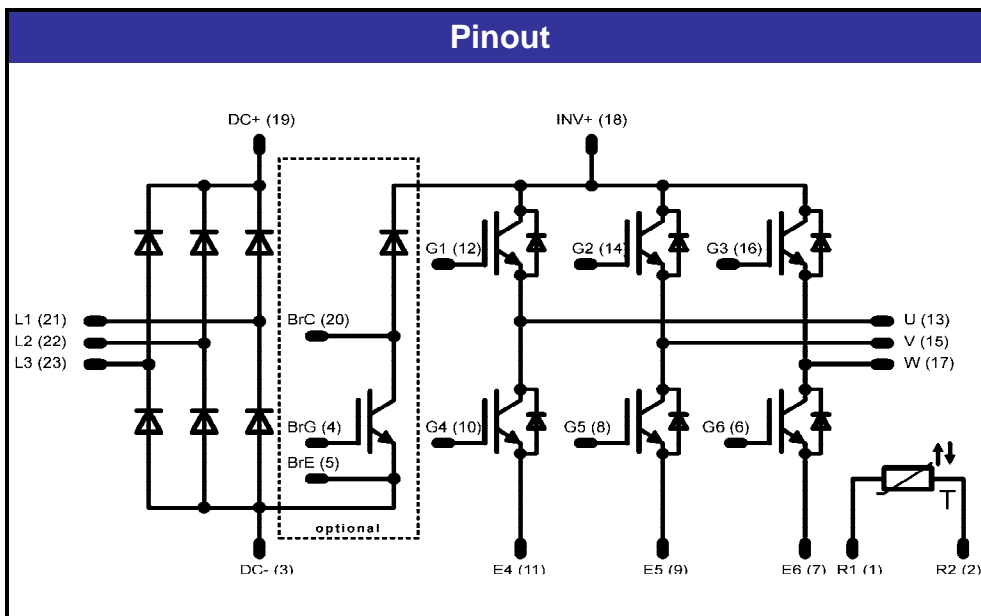
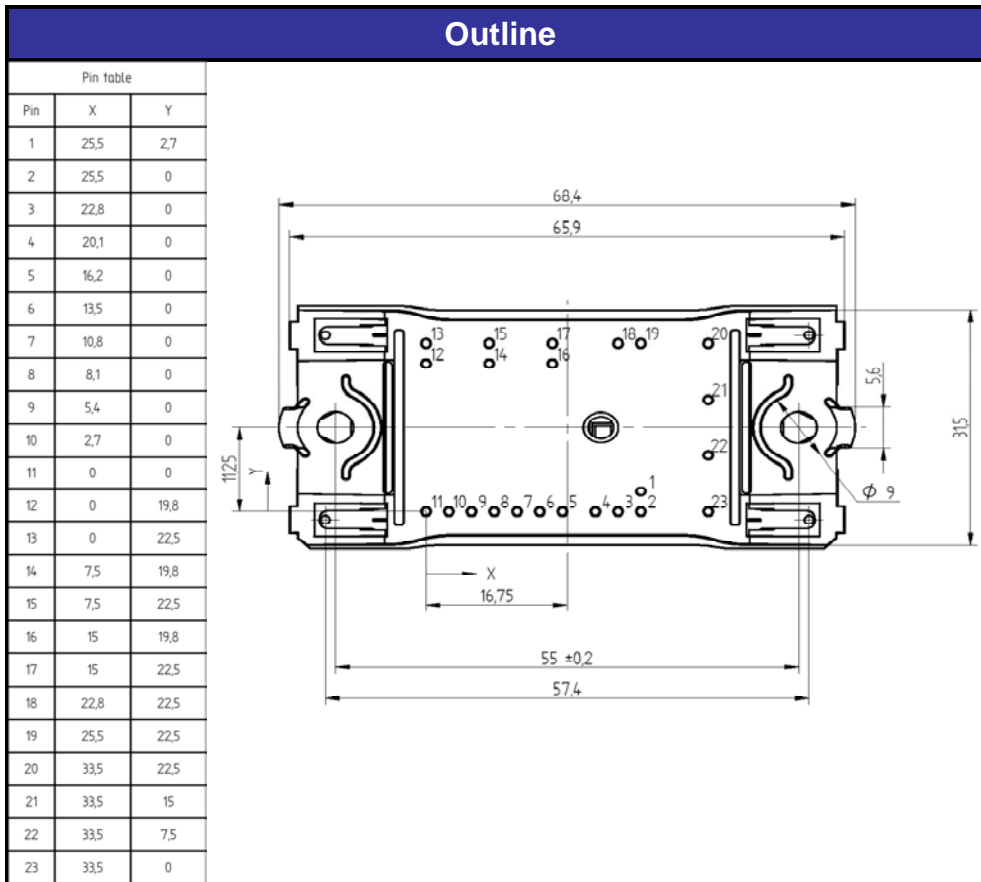

PRODUCT STATUS DEFINITIONS

Datasheet Status	Product Status	Definition
Target	Formative or In Design	This datasheet contains the design specifications for product development. Specifications may change in any manner without notice. The data contained is exclusively intended for technically trained staff.
Preliminary	First Production	This datasheet contains preliminary data, and supplementary data may be published at a later date. Vincotech reserves the right to make changes at any time without notice in order to improve design. The data contained is exclusively intended for technically trained staff.
Final	Full Production	This datasheet contains final specifications. Vincotech reserves the right to make changes at any time without notice in order to improve design. The data contained is exclusively intended for technically trained staff.

DISCLAIMER

Vincotech reserves the right to make changes without further notice to any products herein to improve reliability, function or design. Vincotech does not assume any liability arising out of the application or use of any product or circuit described herein; neither does it convey any license under its patent rights, nor the rights of others.

LIFE SUPPORT POLICY

Vincotech products are not authorised for use as critical components in life support devices or systems without the express written approval of Vincotech.

As used herein:

1. Life support devices or systems are devices or systems which, (a) are intended for surgical implant into the body, or (b) support or sustain life, or (c) whose failure to perform when properly used in accordance with instructions for use provided in labelling can be reasonably expected to result in significant injury to the user.
2. A critical component is any component of a life support device or system whose failure to perform can be reasonably expected to cause the failure of the life support device or system, or to affect its safety or effectiveness.