

CKCL22JB1H103M085AA

TDK Item Description : CKCL22JB1H103MT****



Application & Main Feature

Commercial Grade (2 in 1 Array)

Series

CKCL22(2012) [EIA CC0805]

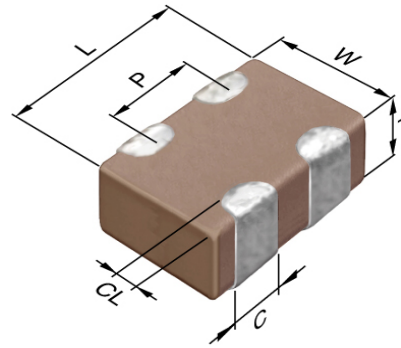

Dimensions

L 2.00mm +/-0.15mm
 W 1.25mm +/-0.15mm
 T 0.85mm +/-0.15mm
 C 0.45mm Nom.
 P 1.00mm Nom.

Temperature Characteristic

JB (-25 to 85 degC +/-10%)

Rated Voltage

1H (50Vdc)

Capacitance

10nF

Capacitance Tolerance

M (+/-20%)

Dissipation Factor

2.5% Max.

Insulation Resistance

10Gohm Min.

AEC-Q200

Not Applicable

DC Bias Characteristic

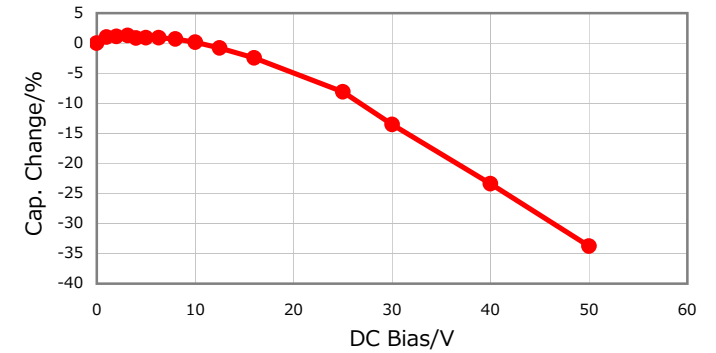

|Z|, ESR vs. Freq. Characteristics

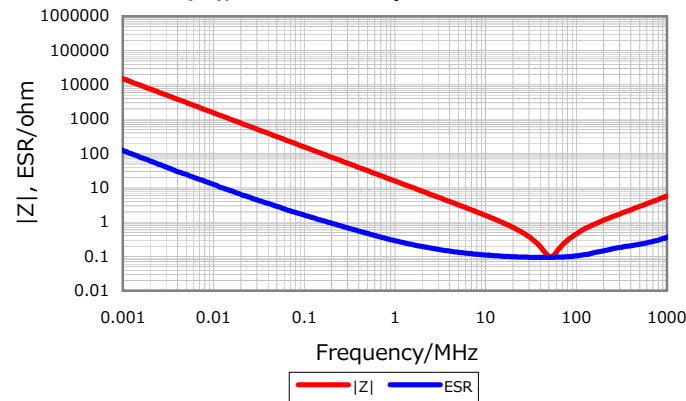

Temperature Characteristics

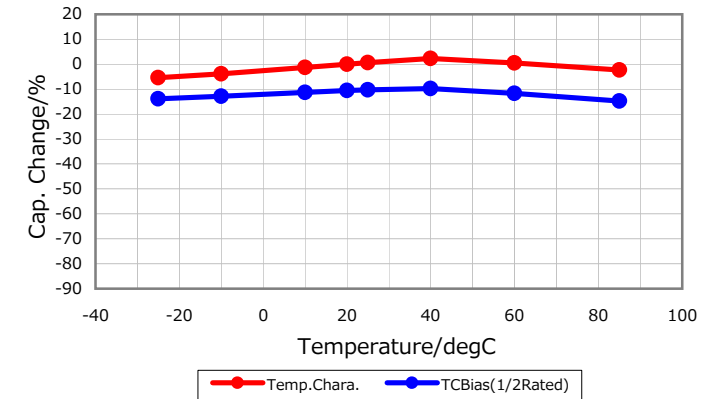

Cap. vs. Freq. Characteristic

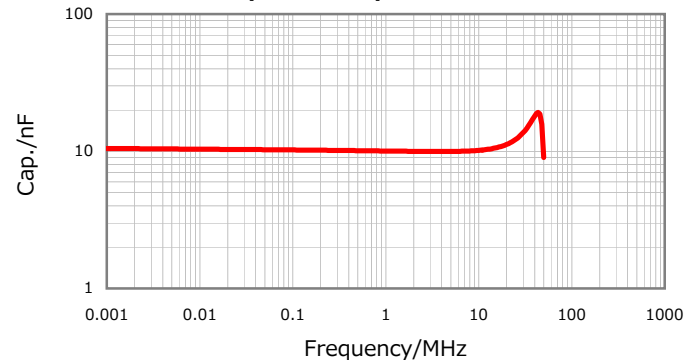

Ripple Temperature Rise Characteristics

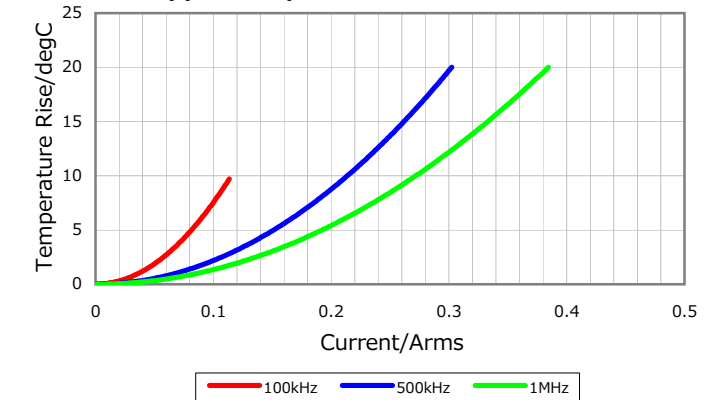

Characterization Sheet (Multilayer Ceramic Chip Capacitors)



All specifications are subject to change without notice.

January 4, 2016