

BNT01



1.5 -3.0 GHz Wideband High Linearity LNA Gain Block

Device Features

- Internally matched to 50 ohms
- This can be operated at Vd of 3.3V and 4.4V
- 37.0 dBm Output IP3 at 5dBm/tone at 1900MHz
- 15.5 dB Gain at 1900MHz
- 22.0 dBm P1dB at 1900 MHz
- 1.6 dB NF at 1900MHz
- Lead-free/Green/RoHS Compliant SOT89 SMT Package



Product Description

BeRex's BNT01 is a wideband high linearity LNA gain block, based on GaAs material with E-pHEMT process and packaged in a RoHS-compliant with SOT-89 Surface mount package. It is designed for use where low noise and high linearity are required and features low noise and high OIP3 at wideband frequency. It is internally matched to 50 Ohms without the need for external matching components. All devices are 100% RF/DC tested and classified as HBM ESD Class 1A.

Typical Performance¹

Parameter	Frequency			Unit
	1900	2140	2650	
Vd = 4.4V	1900	2140	2650	MHz
Gain	15.5	14.5	13.0	dB
S11	-16.5	-17.0	-19.5	dB
S22	-20.0	-18.5	-13.0	dB
OIP3 ²	37.0	37.0	36.0	dBm
P1dB	22.0	22.0	22.0	dBm
Noise Figure	1.6	1.7	1.8	dB

Applications

- Base station Infrastructure/RFID
- Commercial/Industrial/Military wireless system

Applications Circuit

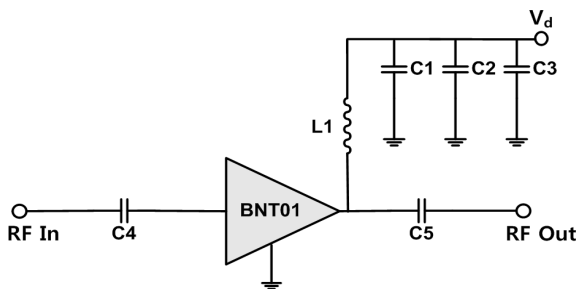

Parameter	Frequency			Unit
	1900	2140	2650	
Vd = 3.3V	1900	2140	2650	MHz
Gain	15.0	14.0	12.5	dB
S11	-16.5	-16.5	-18.0	dB
S22	-21.0	-19.5	-13.5	dB
OIP3 ³	35.5	36.0	35.0	dBm
P1dB	19.5	20.0	20.0	dBm
Noise Figure	1.6	1.6	1.7	dB

¹ Device performance _ measured on BeRex's evaluation board at 25°C, 50 Ω system.

² OIP3 _ measured on two tones with a output power 5 dBm/ tone , F2—F1 = 1 MHz.

³ OIP3 _ measured on two tones with a output power 3dBm/ tone , F2—F1 = 1 MHz.

BOM	Value	Size	Tolerance
C1	100pF	0603	5%
C2	1000pF	0603	5%
C3	10uF	1206	10%
C4	9pF	0603	±0.25pF
C5	43pF	0603	5%
L1	39nH	0603	5%

	Min.	Typical	Max.	Unit
Bandwidth	1500		3000	MHz
I _d @ (Vd = 4.4V)	56	68	80	mA
I _d @ (Vd = 3.3V)	37	47	57	
dG/dT		-0.003		dB/°C
R _{TH}		95		°C/W

BNT01

1.5—3.0 GHz Wideband High Linearity LNA Gain Block



Absolute Maximum Ratings

Parameter	Rating	Unit
Operating Case Temperature	-40 to +85	°C
Storage Temperature	-55 to +155	°C
Junction Temperature	+220	°C
Operating Voltage	+6	V
Supply Current	130	mA
Input RF Power	23	dBm

Operation of this device above any of these parameters may result in permanent damage.

V-I Characteristics

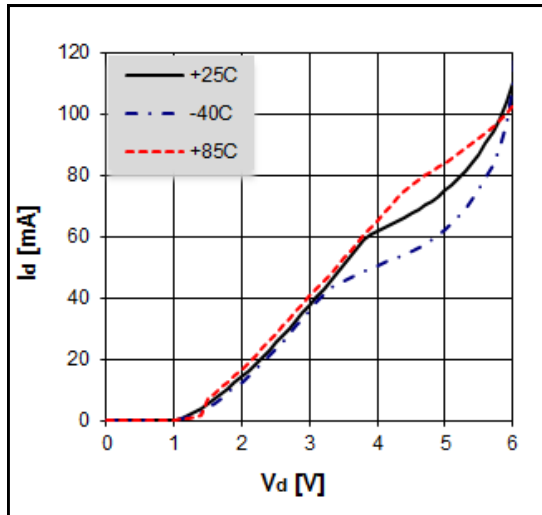

BeRex SOT89 Evaluation Board

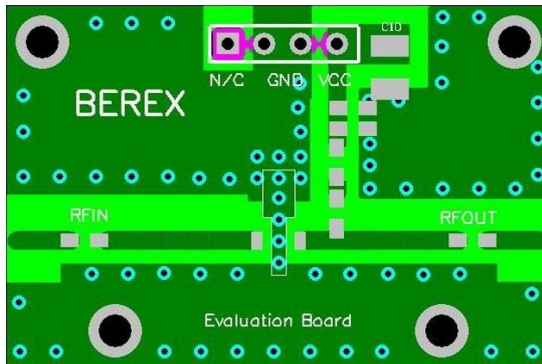

*Dielectric constant ϵ_r 4.2 *RF pattern width 52mil *31mil thick FR4 PCB

BNT01

1.5 - 3.0 GHz Wideband High Linearity LNA Gain Block



Preliminary Datasheet

Typical Device Data

S-parameters ($V_d=4.4V, I_d=68mA, T=25^\circ C$)

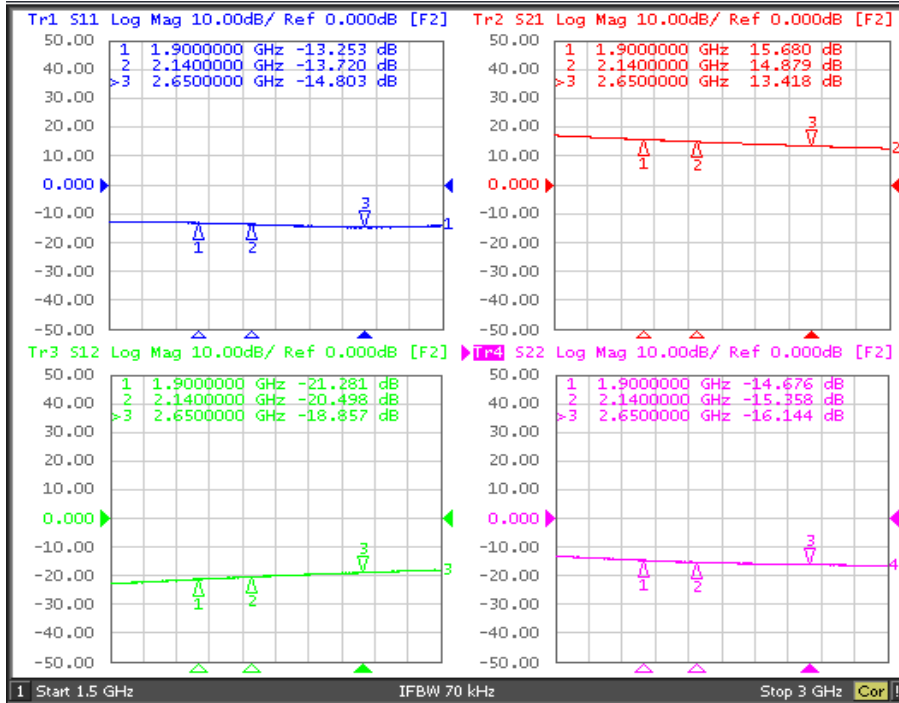

S-parameters ($V_d=3.3V, I_d=47mA, T=25^\circ C$)

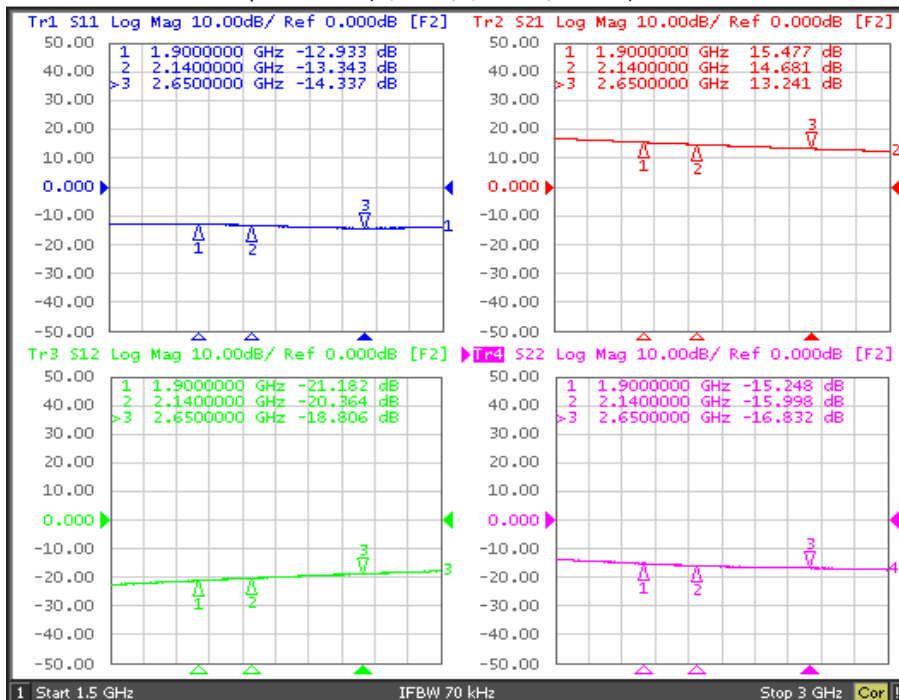

BNT01



1.5 - 3.0 GHz Wideband High Linearity LNA Gain Block

S-Parameter

(Vd=4.4V, Id = 68mA, T = 25 °C, calibrated to device leads)

Freq [MHz]	S11 Mag	S11 Ang	S21 Mag	S21 Ang	S12 Mag	S12 Ang	S22 Mag	S22 Ang
1500	0.21	155.96	7.19	90.39	0.07	28.60	0.22	73.75
2000	0.23	145.09	5.83	72.67	0.09	26.29	0.18	59.00
2500	0.23	133.56	4.90	57.27	0.11	20.75	0.14	40.48
3000	0.23	118.22	4.22	42.87	0.13	14.03	0.11	23.19
3500	0.26	102.19	3.71	29.21	0.15	6.66	0.11	16.14
4000	0.30	88.92	3.34	15.62	0.16	-1.45	0.11	23.35

(Vd=3.3V, Id = 47mA, T = 25 °C, calibrated to device leads)

Freq [MHz]	S11 Mag	S11 Ang	S21 Mag	S21 Ang	S12 Mag	S12 Ang	S22 Mag	S22 Ang
1500	0.21	162.00	7.01	91.01	0.07	27.71	0.20	76.38
2000	0.24	148.94	5.70	73.25	0.09	26.75	0.17	63.05
2500	0.24	136.58	4.79	57.65	0.11	21.42	0.13	45.92
3000	0.24	121.21	4.14	43.10	0.13	13.96	0.11	29.25
3500	0.27	104.45	3.65	29.40	0.15	6.26	0.10	23.24
4000	0.30	90.91	3.28	15.83	0.17	-1.81	0.11	31.06

BNT01



1.5 - 3.0 GHz Wideband High Linearity LNA Gain Block

S-Parameter

Typical Performance ($V_d=4.4V$, $I_d=68mA$, $T = 25^\circ C$)

Freq	MHz	1900	2140	2650
S21	dB	15.3	14.5	12.7
S11	dB	-16.5	-17.0	-19.5
S22	dB	-20.0	-18.5	-13.0
P1	dBm	22.0	22.0	22.0
OIP3	dBm	37.0	37.0	36.0
NF	dB	1.6	1.7	1.8

Typical Performance ($V_d=3.3V$, $I_d=47mA$, $T = 25^\circ C$)

Freq	MHz	1900	2140	2650
S21	dB	15.1	14.2	12.5
S11	dB	-16.5	-16.5	-18.0
S22	dB	-21.0	-19.5	-13.5
P1	dBm	19.5	20	20.0
OIP3	dBm	35.5	36.0	35.5
NF	dB	1.5	1.7	1.8

BNT01

1.5 - 3.0 GHz Wideband High Linearity LNA Gain Block



Preliminary Datasheet

WCDMA 4FA 2140MHz -50dBc (Vd=4.4V)

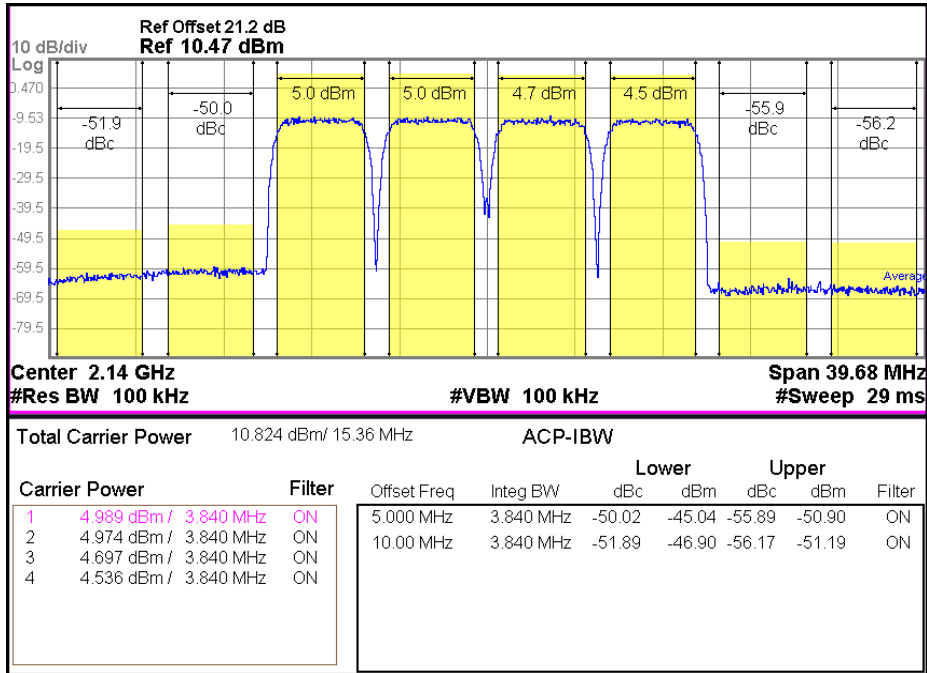

WCDMA 4FA 2140MHz -50dBc (Vd=3.3V)

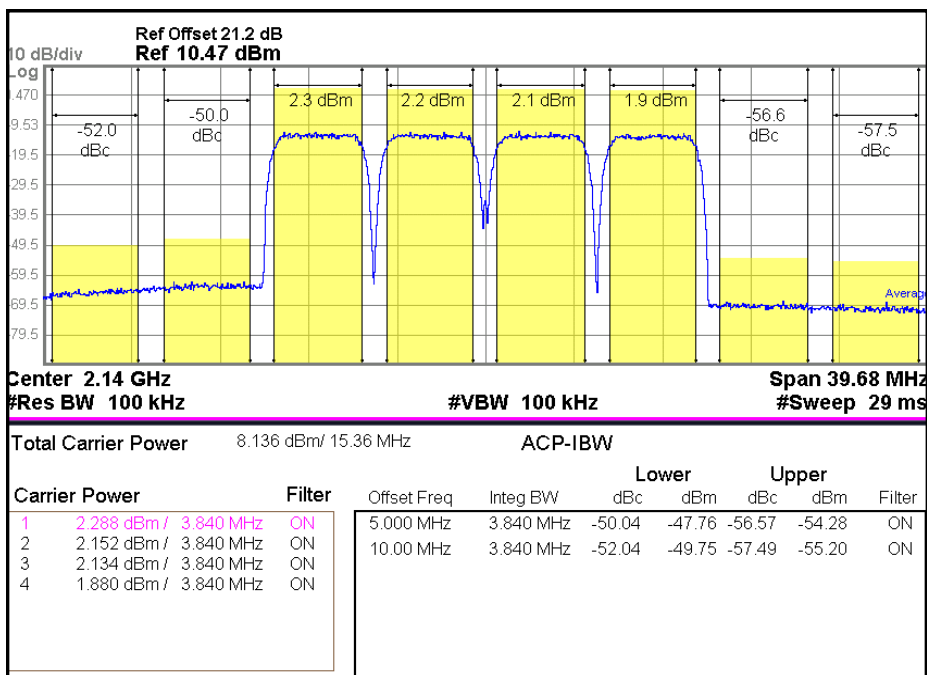

BNT01

1.5 - 3.0 GHz Wideband High Linearity LNA Gain Block



Preliminary Datasheet

WCDMA 6FA 2140MHz -50dBc (Vd=4.4V)

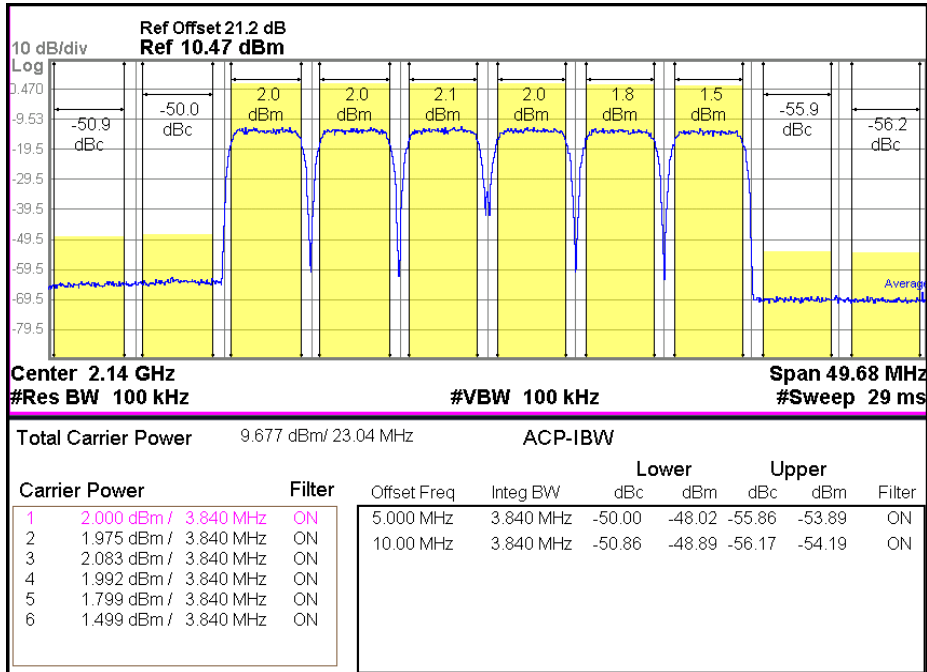

WCDMA 6FA 2140MHz -50dBc (Vd=3.3V)

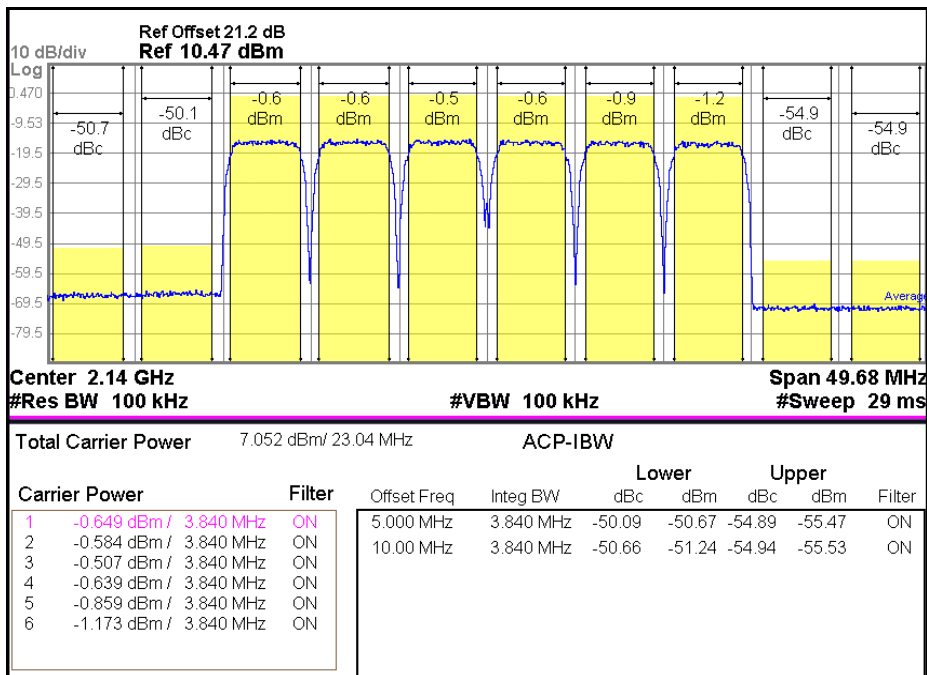

BNT01

1.5 - 3.0 GHz Wideband High Linearity LNA Gain Block



LTE TM3p1 100% 20MHz 1850MHz -50dBc (Vd=4.4V)

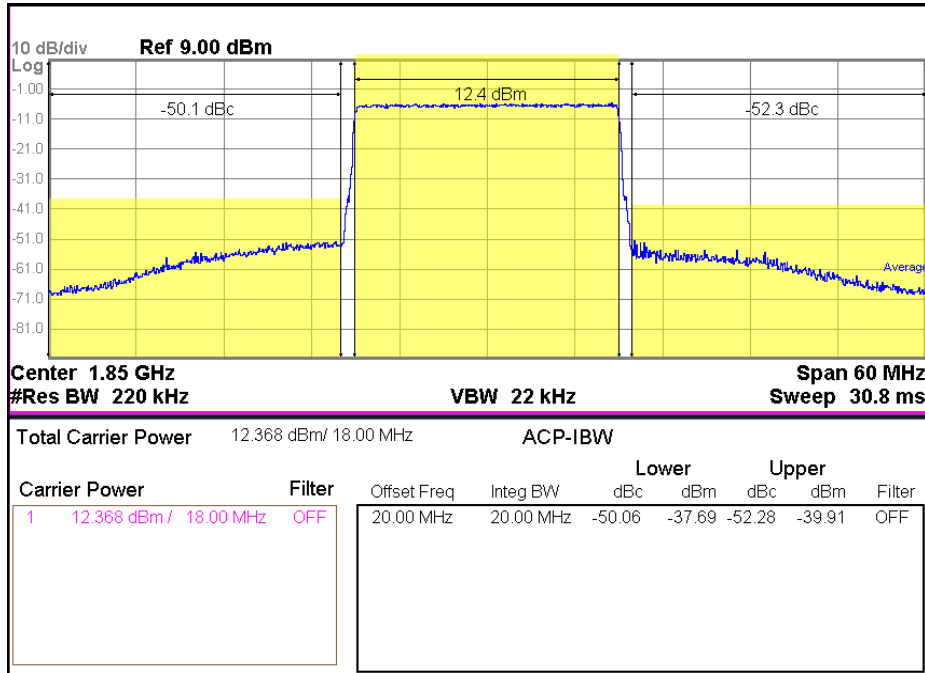

LTE TM3p1 100% 20MHz 1850MHz -50dBc (Vd=3.3V)

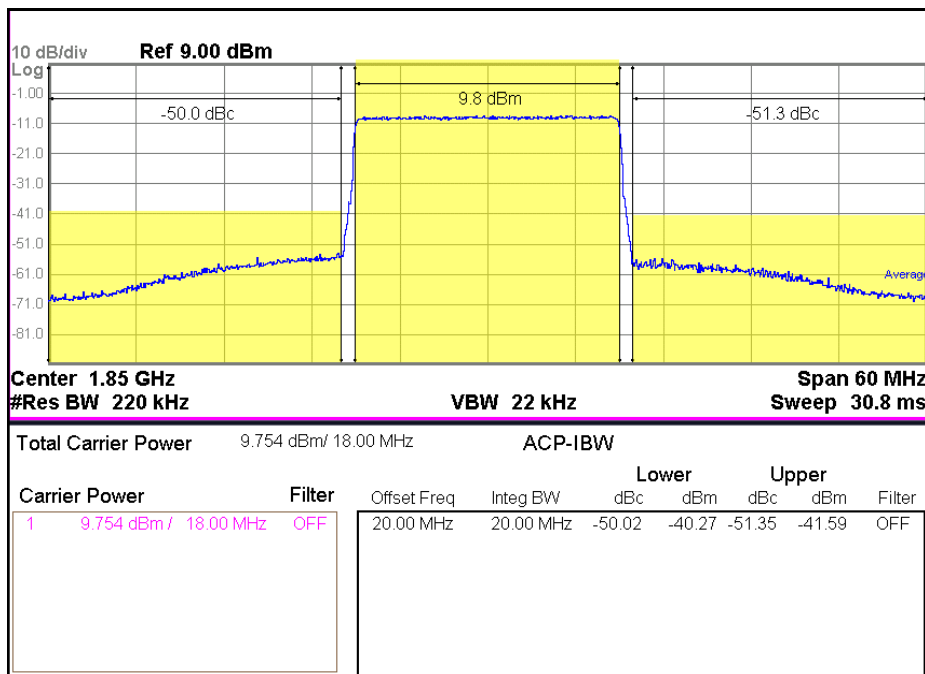

Preliminary Datasheet

BNT01

1.5 - 3.0 GHz Wideband High Linearity LNA Gain Block



LTE TM3p1 100% 20MHz 2650MHz -50dBc (Vd=4.4V)

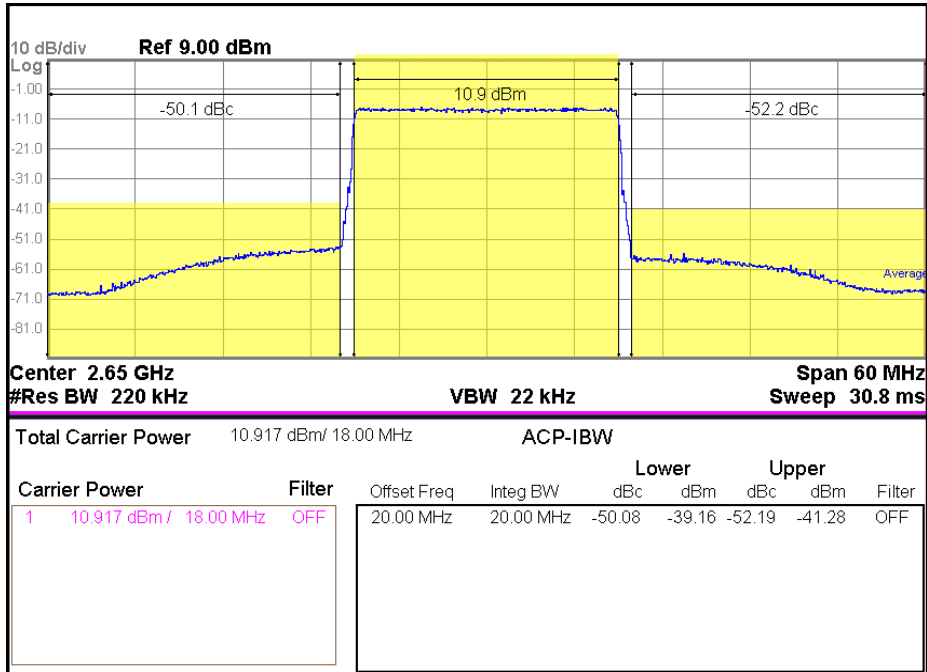

LTE TM3p1 100% 20MHz 2650MHz -50dBc (Vd=3.3V)

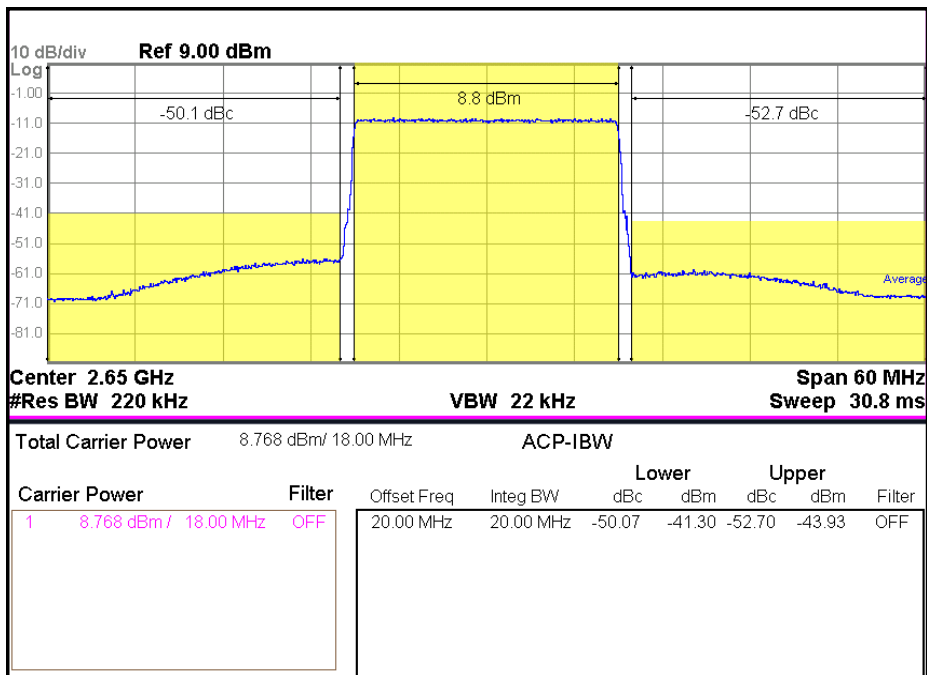

Preliminary Datasheet

BNT01

1.5 - 3.0 GHz Wideband High Linearity LNA Gain Block



Preliminary Datasheet

Device Performance

Pin-Pout-Gain

$V_d = 4.4V, I_d = 68mA$

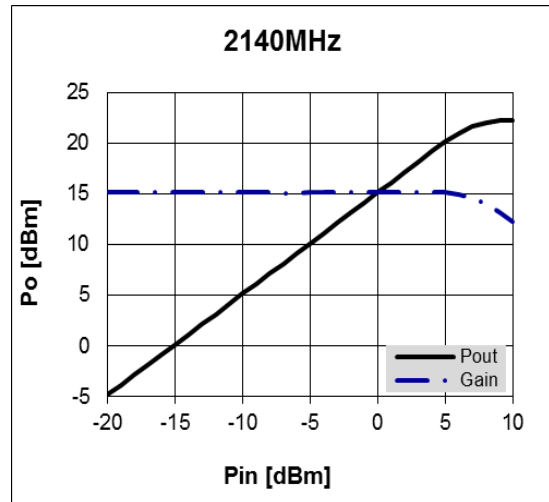
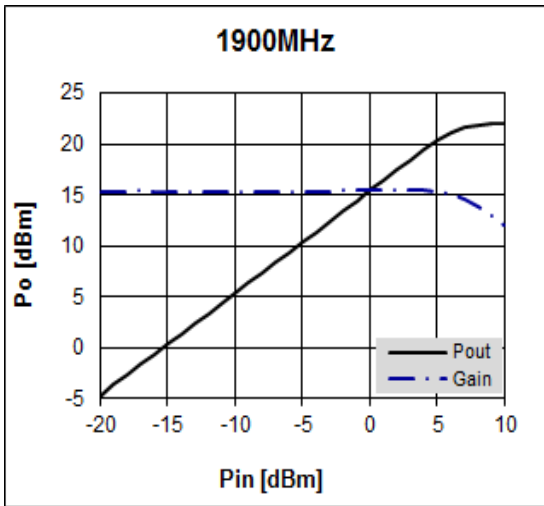

$V_d = 3.3V, I_d = 47mA$

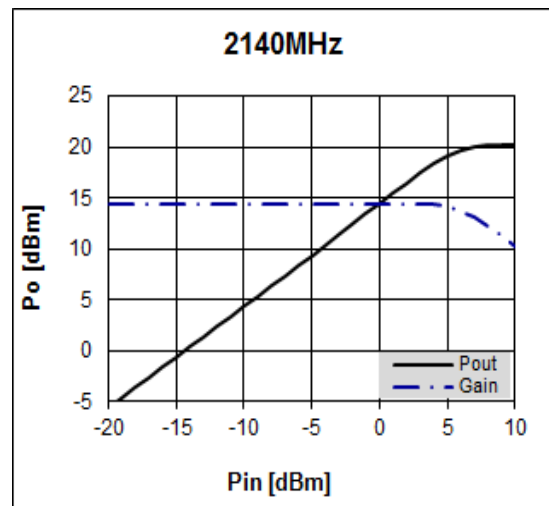
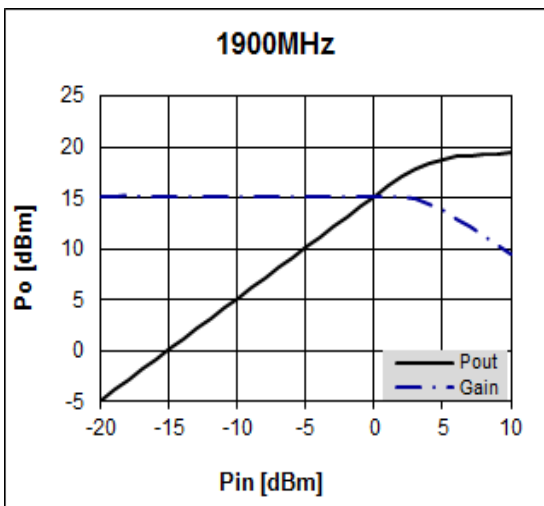

BNT01

1.5 - 3.0 GHz Wideband High Linearity LNA Gain Block



OIP3

$V_d = 4.4V, I_d = 68mA$

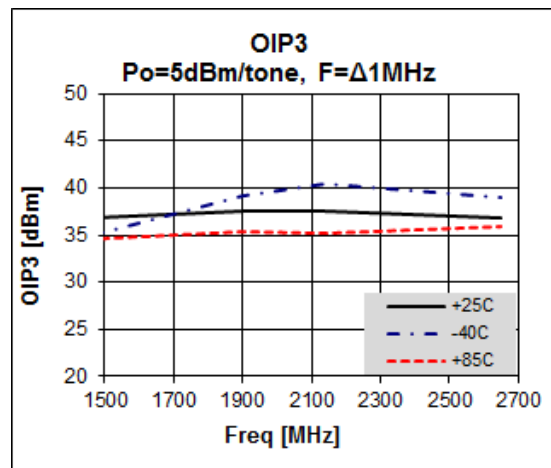
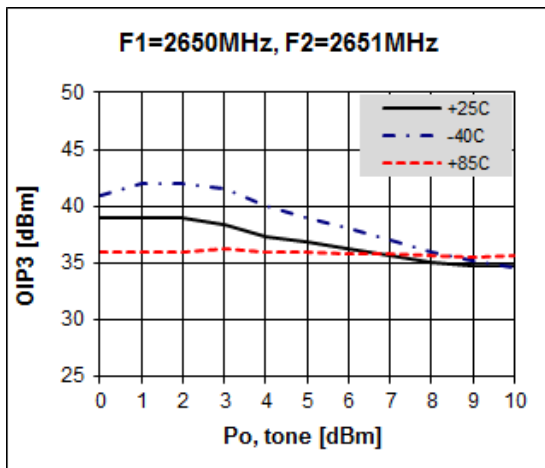
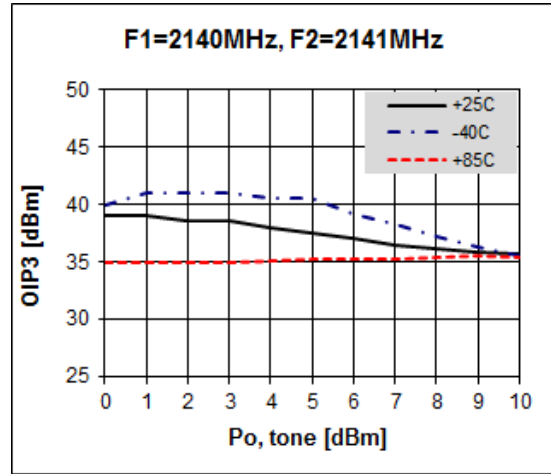
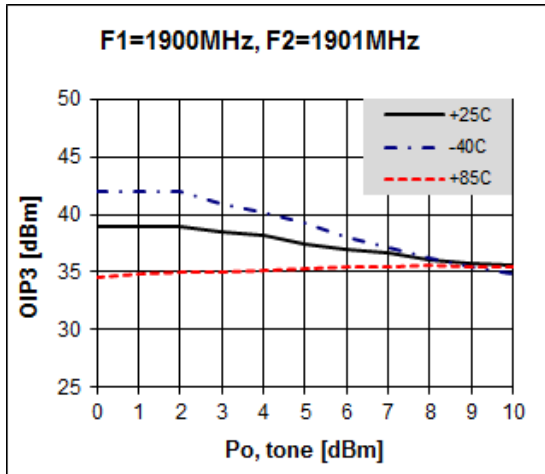

Preliminary Datasheet

BNT01

1.5 - 3.0 GHz Wideband High Linearity LNA Gain Block



OIP3

$V_d = 3.3V, I_d = 47mA$

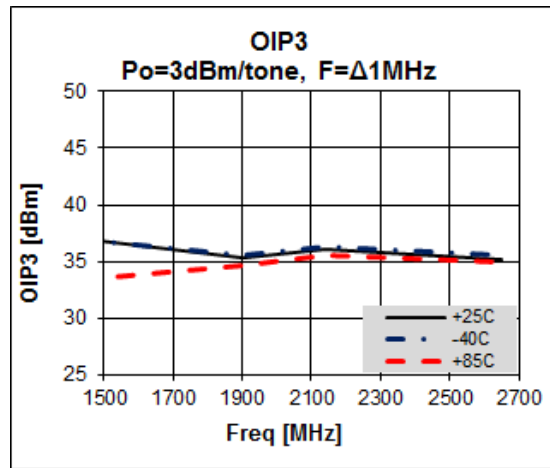
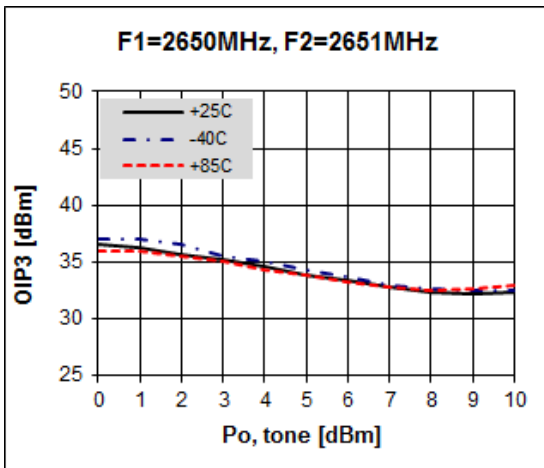
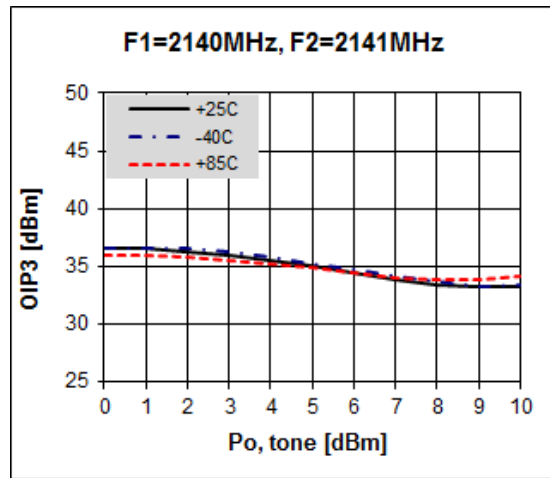
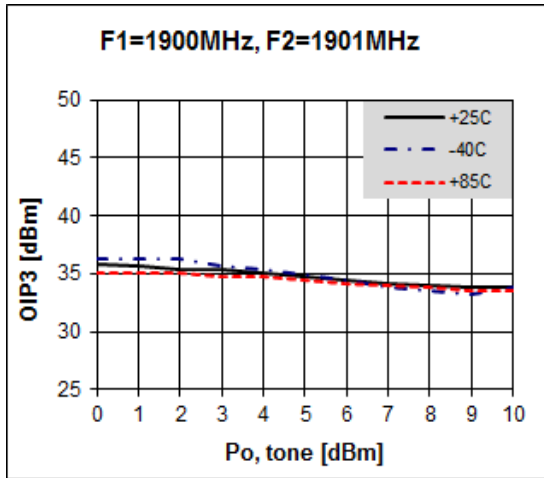

Preliminary Datasheet

BNT01

1.5 - 3.0 GHz Wideband High Linearity LNA Gain Block



ACLR

$V_d = 4.4V, I_d = 68mA$

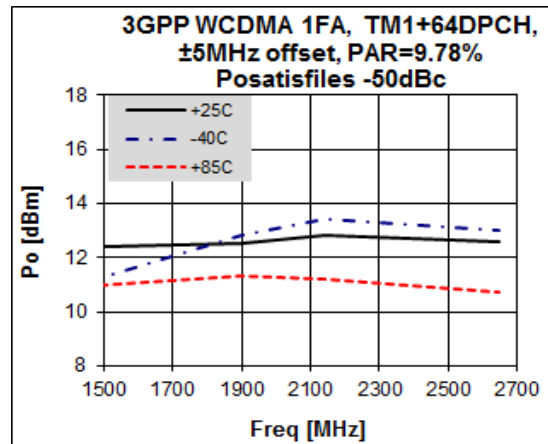
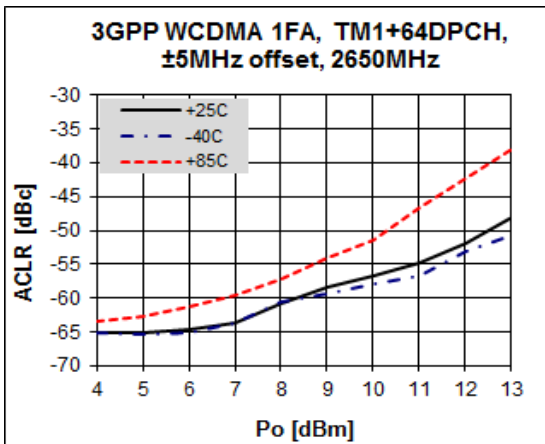
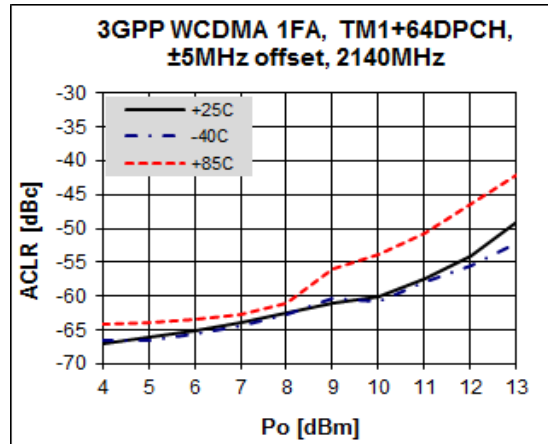
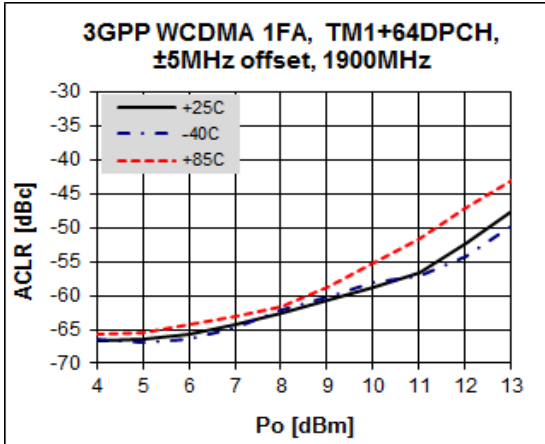

Preliminary Datasheet

BNT01

1.5 - 3.0 GHz Wideband High Linearity LNA Gain Block



ACLR

$V_d = 3.3V, I_d = 47mA$

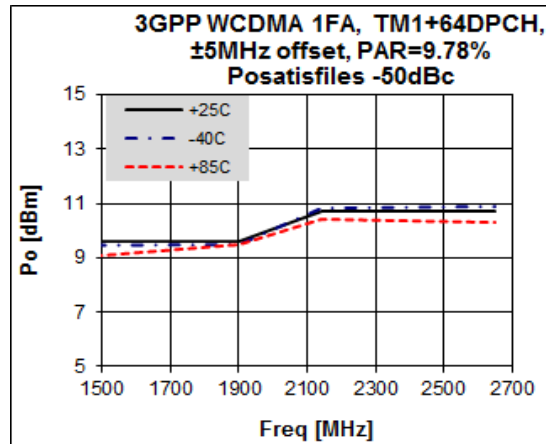
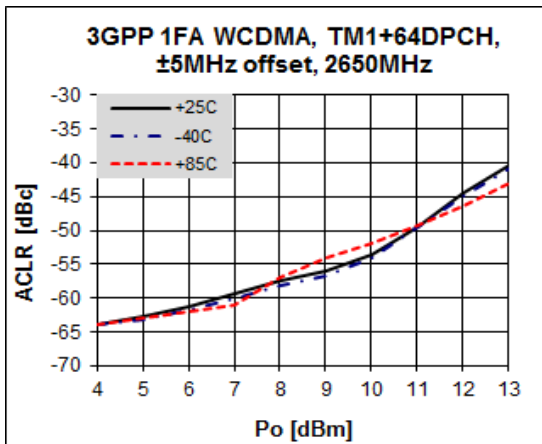
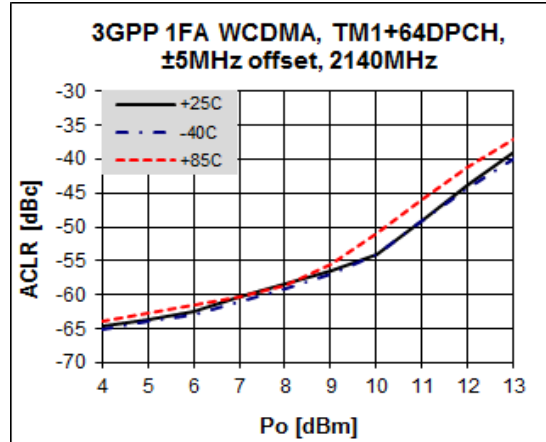
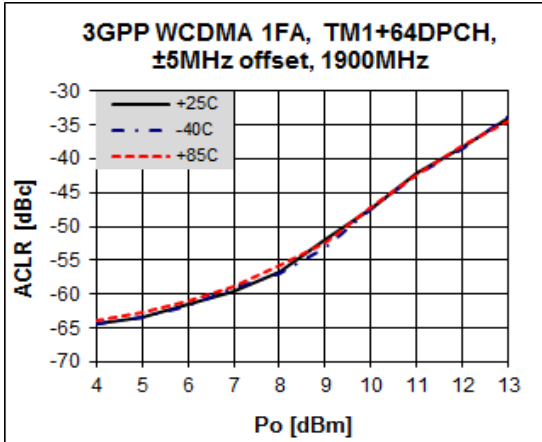

Preliminary Datasheet

BNT01

1.5 - 3.0 GHz Wideband High Linearity LNA Gain Block



Preliminary Datasheet

Gain Flatness

$V_d = 4.4V, I_d = 68mA$

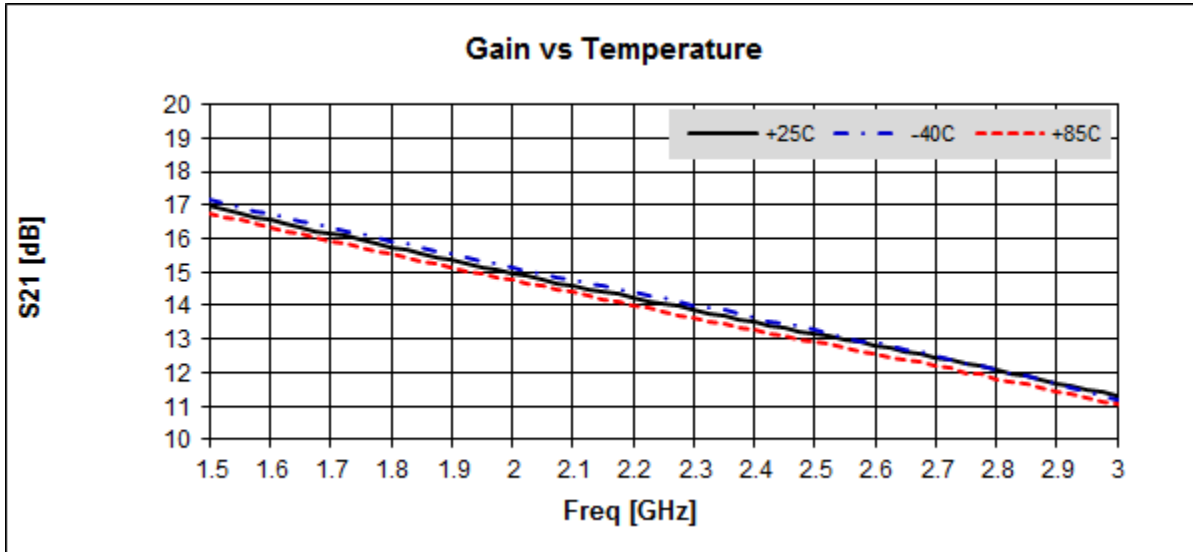

$V_d = 3.3V, I_d = 47mA$

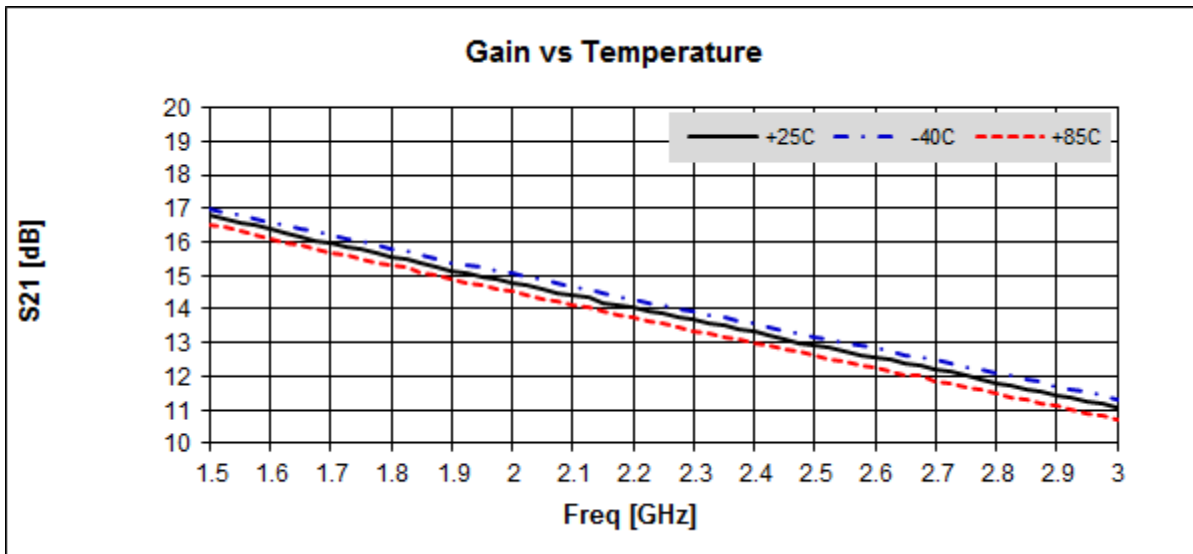

BNT01

1.5 - 3.0 GHz Wideband High Linearity LNA Gain Block



Package Outline Dimension

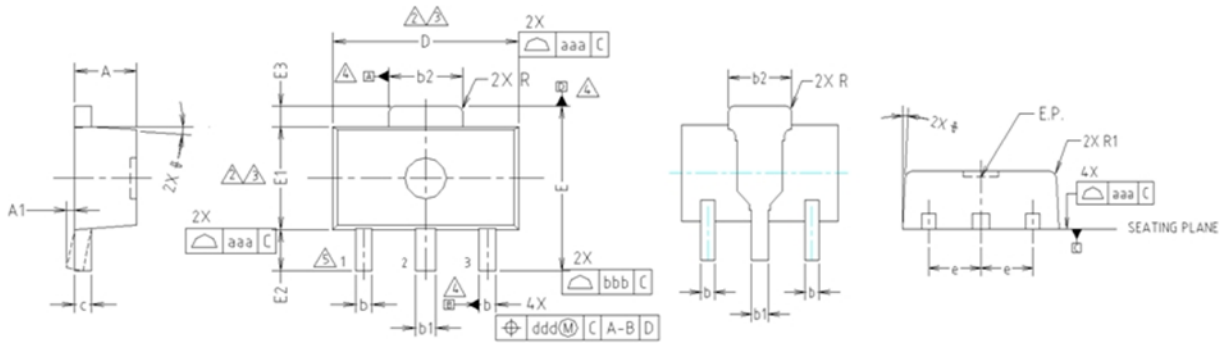

- NOTE:**
 1. DIMENSIONS IN MILLIMETERS.
- ⚠ DIMENSION D DOES NOT INCLUDE MOLD FLASH, PROTRUSIONS OR GATE BURRS. MOLD FLASH, PROTRUSIONS OR GATE BURRS SHALL NOT EXCEED 0.5mm PER END. DIMENSION E1 DOES NOT INCLUDE INTERLEAD FLASH OR PROTRUSION. INTERLEAD FLASH OR PROTRUSION SHALL NOT EXCEED 0.5mm PER SIDE.
 - ⚠ DIMENSIONS D AND E1 ARE DETERMINED AT THE OUTMOST EXTREMES OF THE PLASTIC BODY EXCLUSIVE OF MOLD FLASH, TIE BAR BURRS, GATE BURRS AND INTERLEAD FLASH, BUT INCLUDING ANY MISMATCH BETWEEN THE TOP AND BOTTOM OF THE PLASTIC BODY.
 - ⚠ DATUMS A, B AND D TO BE DETERMINED 0.18mm FROM THE LEAD TIP.
 - ⚠ TERMINAL NUMBERS ARE SHOWN FOR REFERENCE ONLY.

SYMBOL	MILLIMETERS			NOTE
	MINIMUM	NOMINAL	MAXIMUM	
A	1.40	1.50	1.60	
A1	0.00	—	0.10	
b	0.38	0.42	0.48	
b1	0.48	0.52	0.58	
b2	1.79	1.82	1.87	
c	0.40	0.42	0.46	
D	4.40	4.50	4.70	2,3
E	3.70	4.00	4.30	
E1	2.40	2.50	2.70	2,3
E2	0.80	1.00	1.20	
E3	0.40	0.50	0.60	
e	1.50 TYP.			
φ	4° TYP.			
R	0.15 TYP.			
R1	—	—	0.20	
SYMBOL	TOLERANCES OF FORM AND POSITION		NOTE	
aaa	0.15			
bbb	0.20			
ccc	0.10			
ddd	0.10			

Suggested PCB Land Pattern and PAD Layout

PCB Land Pattern

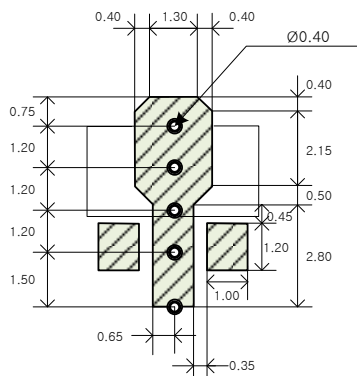

Note : All dimension _ millimeters

PCB lay out _ on BeRex website

PCB Mounting

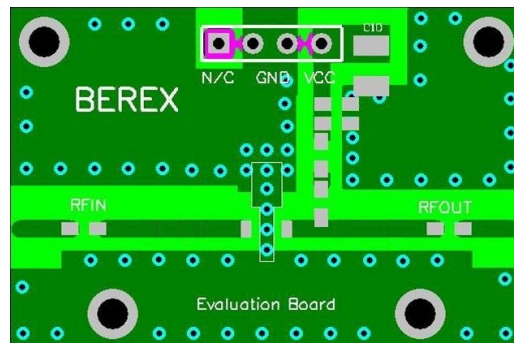

BNT01

1.5 - 3.0 GHz Wideband High Linearity LNA Gain Block



Package Marking

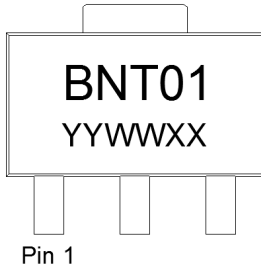

YY = Year, WW = Working Week,
XX = Wafer No.

Tape & Reel

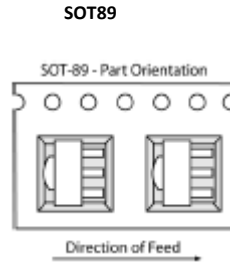

Packaging information:

- Tape Width (mm): 12
- Reel Size (inches): 7
- Device Cavity Pitch (mm): 8
- Devices Per Reel: 1000

Lead plating finish

100% Tin Matte finish

(All BeRex products undergoes a 1 hour, 150 degree C, Anneal bake to eliminate thin whisker growth concerns.)

MSL / ESD Rating

ESD Rating:	Class 1A
Value:	Passes <500V
Test:	Human Body Model (HBM)
Standard:	JEDEC Standard JESD22-A114B
MSL Rating:	Level 1 at +265°C convection reflow
Standard:	JEDEC Standard J-STD-020

NATO CAGE code:

2	N	9	6	F
---	---	---	---	---