

S-Band 6-bit Phase Shifter

GaAs Monolithic Microwave IC

Description

The CHP1102-98F is 6-bit phase shifter with an amplifier at its input and output. The circuit is driven by a TTL compatible parallel interface. It is designed for radar systems.

The circuit is manufactured with a power pHEMT process, 0.25µm gate length, via holes through the substrate and air bridges.

It is available in chip form.

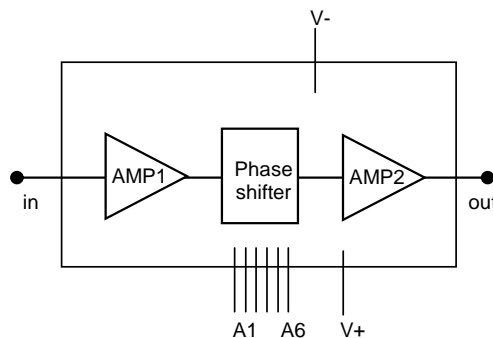

Main Features

- Operating frequency range: 2.7-3.4GHz
- 6-bit phase shifter
- 5.625° phase step
- 10dB gain
- 0/+3.3V phase shifter control voltage
- 13dBm output @ 1dB comp.

- Chip size: 3.14x3.29x0.1mm

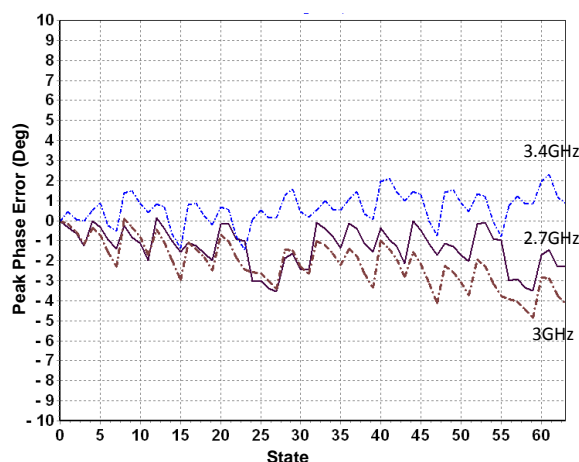

Peak Phase Error vs State @ 2.7, 3, 3.4GHz
(on wafer measurements)

Main Characteristics

Tamb= +25°C, V+= +5V, V-= -5V

Symbol	Parameter	Min	Typ	Max	Unit
Freq	Frequency range	2.7		3.4	GHz
Gain	Small signal gain (state 0)	9	10		dB
RMS_PPE	RMS Peak Phase Error		1		deg

ESD Protections: Electrostatic discharge sensitive device observe handling precautions!

Main Characteristics

Tamb.= +25°C

Symbol	Parameter	Min	Typ	Max	Unit
Fop	Operating frequency range	2.7		3.4	GHz
G	Small signal gain (state 0)	9	10		
Gvt	Small signal gain variation versus temperature		0.03		dB/°C
NF	Noise figure (state 0)		5.8		dB
S11	Input reflection coefficient		-15		dB
S22	Output reflection coefficient		-15		dB
PPEa	Peak phase error for states 1 to 2		+/- 1.5		°
PPEb	Peak phase error for states 3 to 14		+/- 3		°
PPEd	Peak phase error for states 15 to 63		+/- 5		°
RMS_PPE	RMS Peak phase error		1		°
Ava	Amplitude variation for states 1 to 4		+/- 0.3		dB
Avb	Amplitude variation for states 5 to 63		+/-0.7		dB
RMS_Av	RMS Amplitude variation		0.3		dB
StdDev_Av	Amplitude variation standard deviation		0.12		dB
P _{-1dB}	Output power at 1dB gain compression		13		dBm
V+	DC positive supply		+5		V
V-	DC negative supply		-5		V
Vctrl_L	Phase shifter control voltage (low state)	-	0	0.4	V
Vctrl_H	Phase shifter control voltage (high state)	2.4	3.3	7	V
I_V+	Courant I+ (state 0 and low level)		100		mA
I_V-	Courant I- (state 0 and low level)		23		mA

These values are representative of on wafer measurements.

Peak Phase Error (PPE) definition

$PPE(i) = \text{measured_Phase}(S21)@state(i) - \text{measured_Phase}(S21)@state(0) - \text{theoreticalPhaseValue}@State(i)$

Amplitude Variation (Av) definition

$Av(i) = \text{Measured_dB}(S21)@state(i) - \text{Measured_dB}(S21)@state(0)$

RMS Peak Phase Error (RMS_PPE) definition

$$RMS_PPE = \sqrt{\frac{\sum_{i=0}^{63} (PPE(i) - \overline{PPE})^2}{64}}$$

$$\text{Where } \overline{PPE} = \frac{\sum_{i=0}^{63} PPE(i)}{64}$$

RMS Amplitude variation (RMS_Av) definition

$$RMS_AV = \overline{Av} = \frac{\sum_{i=0}^{63} Av(i)}{64}$$

Amplitude variation standart deviation (StdDev_Av) definition

$$StdDev_Av = 20 \log \left(1 + \sqrt{\frac{1}{64} \cdot \sum_{i=0}^{63} (1 - Av(i)_{lin})^2} \right) \text{ (dB)}$$

The translation of $Av(i)$ from dB to linear is given by: $Av(i)_{lin} = 10^{\frac{Av(i)}{20}}$
(i) is in the range [0:63]

Absolute Maximum Ratings ⁽¹⁾

Tamb.= +25°C

Symbol	Parameter	Values	Unit
V+	Maximum DC positive supply	+6	V
V-	Maximum DC negative supply	-6	V
Vctrl	Phase shifter control voltage (Vlow Vhigh)	-0.5 +5.5	V
Pin	Maximum peak input power overdrive	+11	dBm
Top	Operating temperature range	-40 to +85	°C
Tstg	Storage temperature range	-55 to +150	°C

⁽¹⁾ Operation of this device above anyone of these parameters may cause permanent damage.

Phase Shifter Control Interface

The phase shifter is controlled by 6 bits (A1 to A6). Reference state is "0". State is "0" when 0V is applied, state is "1" when +3.3V is applied.

State	A1	A2	A3	A4	A5	A6	Phase (deg)
0	0	0	0	0	0	0	0
1	1	0	0	0	0	0	5,625
2	0	1	0	0	0	0	11,25
3	1	1	0	0	0	0	16,875
4	0	0	1	0	0	0	22,5
5	1	0	1	0	0	0	28,125
6	0	1	1	0	0	0	33,75
7	1	1	1	0	0	0	39,375
8	0	0	0	1	0	0	45
9	1	0	0	1	0	0	50,625
10	0	1	0	1	0	0	56,25
11	1	1	0	1	0	0	61,875
12	0	0	1	1	0	0	67,5
13	1	0	1	1	0	0	73,125
14	0	1	1	1	0	0	78,75
15	1	1	1	1	0	0	84,375
16	0	0	0	0	1	0	90
17	1	0	0	0	1	0	95,625
18	0	1	0	0	1	0	101,25
19	1	1	0	0	1	0	106,875
20	0	0	1	0	1	0	112,5
21	1	0	1	0	1	0	118,125
22	0	1	1	0	1	0	123,75
23	1	1	1	0	1	0	129,375
24	0	0	0	1	1	0	135
25	1	0	0	1	1	0	140,625
26	0	1	0	1	1	0	146,25
27	1	1	0	1	1	0	151,875
28	0	0	1	1	1	0	157,5
29	1	0	1	1	1	0	163,125
30	0	1	1	1	1	0	168,75
31	1	1	1	1	1	0	174,375
32	0	0	0	0	0	1	180
33	1	0	0	0	0	1	185,625
34	0	1	0	0	0	1	191,25
35	1	1	0	0	0	1	196,875
36	0	0	1	0	0	1	202,5
37	1	0	1	0	0	1	208,125
38	0	1	1	0	0	1	213,75
39	1	1	1	0	0	1	219,375
40	0	0	0	1	0	1	225
41	1	0	0	1	0	1	230,625
42	0	1	0	1	0	1	236,25
43	1	1	0	1	0	1	241,875
44	0	0	1	1	0	1	247,5
45	1	0	1	1	0	1	253,125
46	0	1	1	1	0	1	258,75
47	1	1	1	1	0	1	264,375
48	0	0	0	0	1	1	270
49	1	0	0	0	1	1	275,625
50	0	1	0	0	1	1	281,25
51	1	1	0	0	1	1	286,875
52	0	0	1	0	1	1	292,5
53	1	0	1	0	1	1	298,125
54	0	1	1	0	1	1	303,75
55	1	1	1	0	1	1	309,375
56	0	0	0	1	1	1	315
57	1	0	0	1	1	1	320,625
58	0	1	0	1	1	1	326,25
59	1	1	0	1	1	1	331,875
60	0	0	1	1	1	1	337,5
61	1	0	1	1	1	1	343,125
62	0	1	1	1	1	1	348,75
63	1	1	1	1	1	1	354,375

Typical S-parameter results (on wafer measurements)

Tamb.= +25°C, V+ = +5V, V- = -5V.

[S] parameters

Gain versus Frequency
All phase states

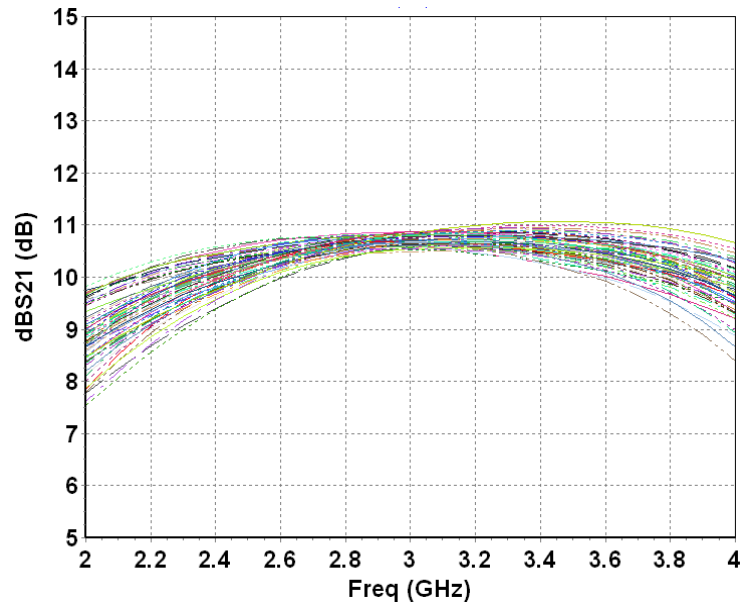

Input return loss versus. Frequency
All phase states

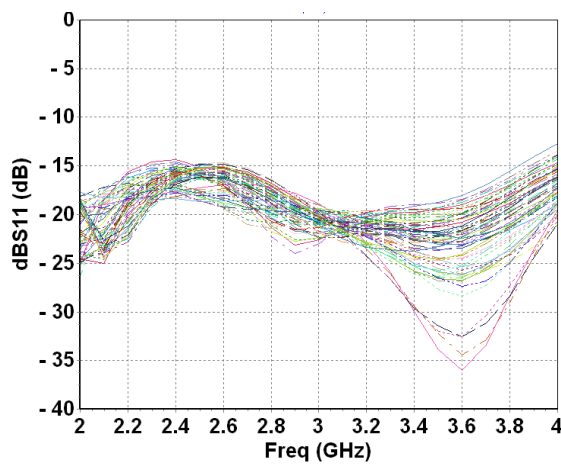

Output return loss versus. Frequency
All phase states

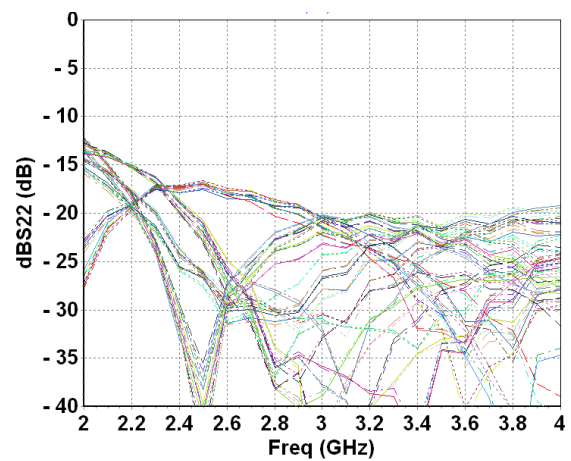

Typical S-parameter results (on wafer measurements)

Tamb.= +25°C, V+ = +5V, V- = -5V

Phase shifter performances: Phase error

Peak phase error versus frequency
(all phase states)

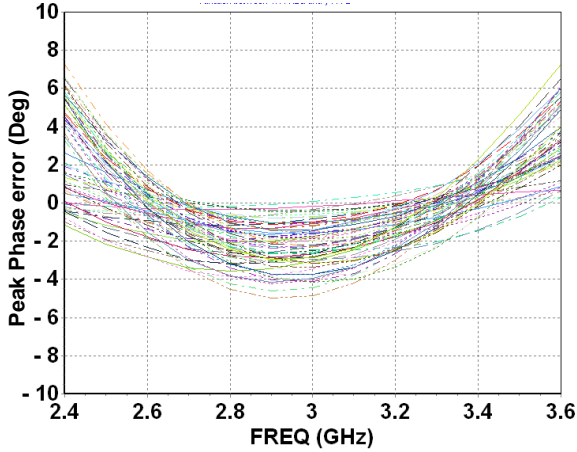

Peak phase error versus state
2.7GHz < frequency < 3.4GHz

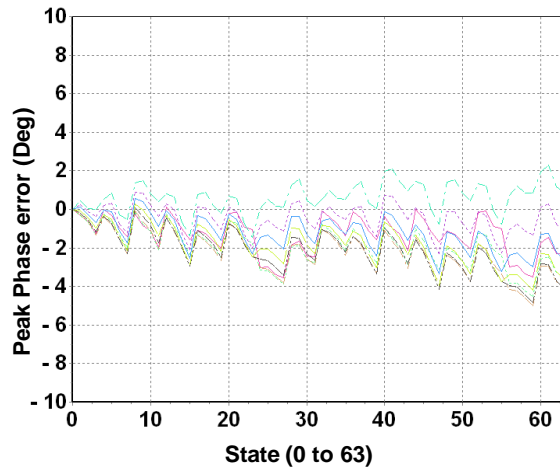

RMS phase error versus frequency for 15 chips

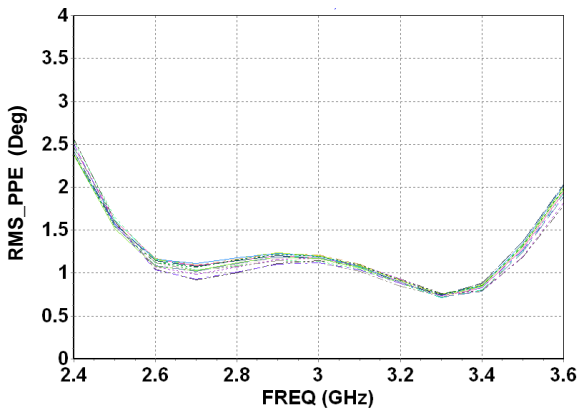

Phase shift versus state
2.7GHz < frequency < 3.4GHz

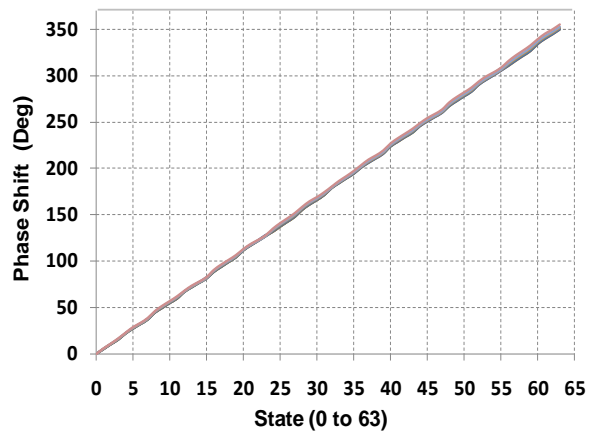

Typical S-parameter results (on wafer measurements)

Tamb.= +25°C, V+ = +5V, V- = -5V

Phase shifter performances: Amplitude variation

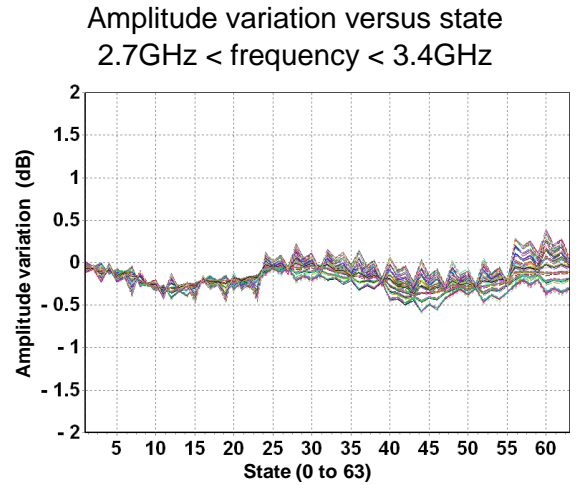
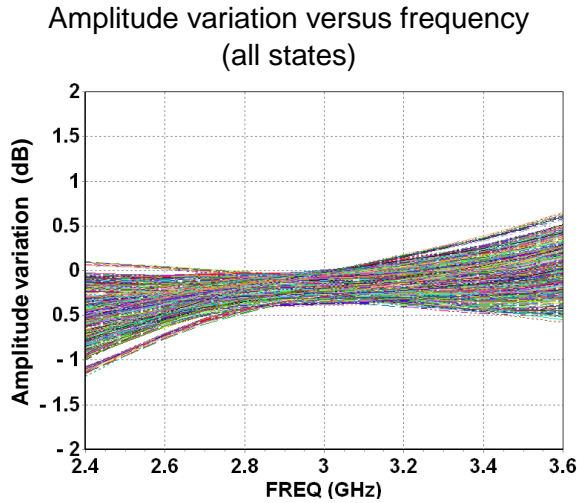

Mechanical dimensions and pad allocation

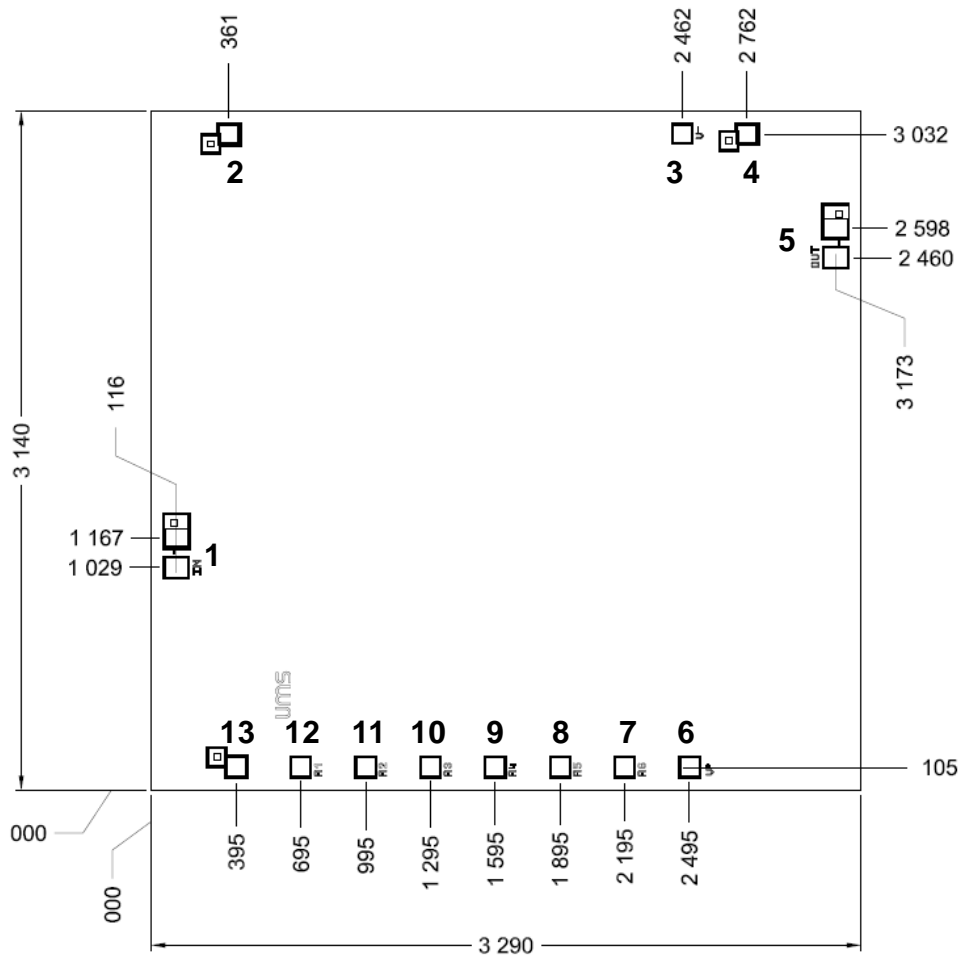

UNITS : μm
Tol : $\pm 35\mu\text{m}$

Chip thickness: $100\mu\text{m} \pm 10\mu\text{m}$

RF pads (1, 5): $122 \times 100\mu\text{m}^2$

DC and control pads (2, 3, 4, 6, 7, 8, 9, 10, 11, 12, 13): $100 \times 100\mu\text{m}^2$

Pin number	Pad name	Description	Voltage Value
1	IN	Input RF	
2, 4, 13		NC	
3	V-	DC negative supply	-5V
5	OUT	Output RF	
6	V+	DC positive supply	+5V
7	A6	Phase shifter bit 6	0V / 3.3V or 0V / 5V
8	A5	Phase shifter bit 5	0V / 3.3V or 0V / 5V
9	A4	Phase shifter bit 4	0V / 3.3V or 0V / 5V
10	A3	Phase shifter bit 3	0V / 3.3V or 0V / 5V
11	A2	Phase shifter bit 2	0V / 3.3V or 0V / 5V
12	A1	Phase shifter bit 1	0V / 3.3V or 0V / 5V

Bonding recommendations

Port	Connection
IN (1) OUT (5)	Inductance (L _{bonding}) = 0.3nH one wire: diameter 25µm, length 0.4mm
DC and Interface pads	Inductance (L _{bonding}) = 0.8nH one wire: diameter 25µm, length 1.0mm

Recommended assembly diagram

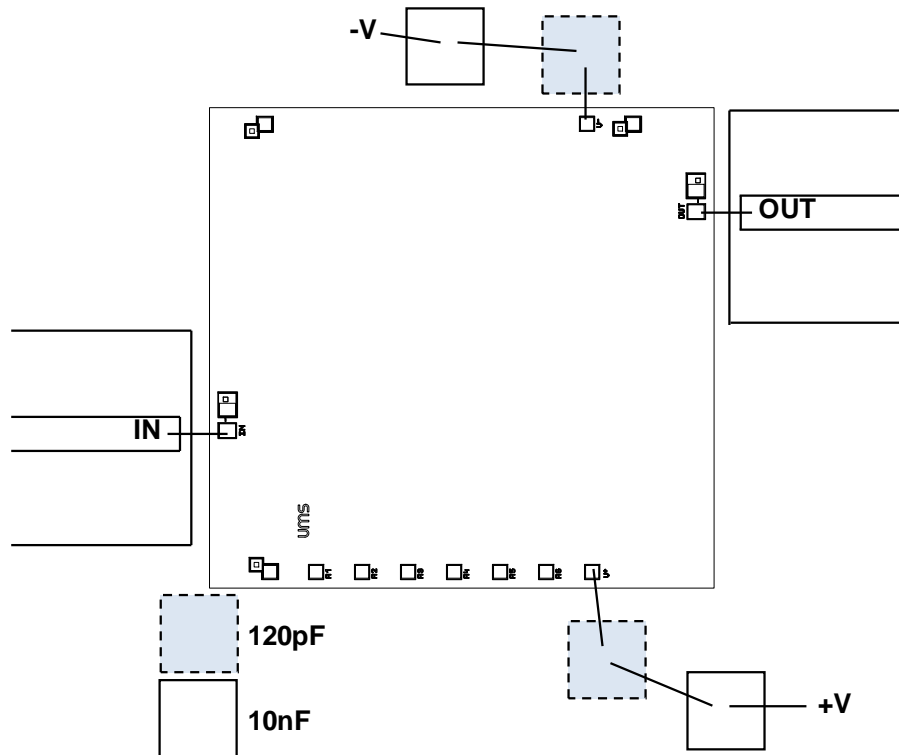

Circuit schematic

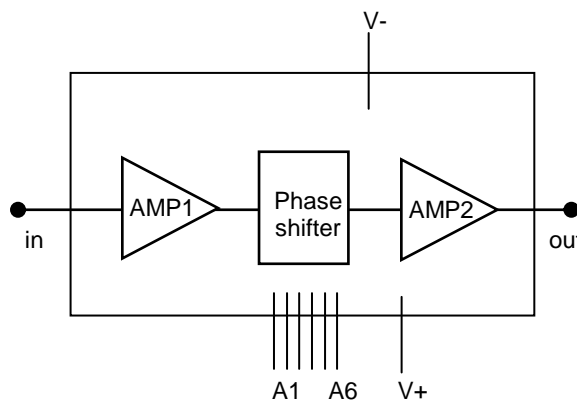

Recommended ESD management

Refer to the application note AN0020 available at <http://www.ums-gaas.com> for ESD sensitivity and handling recommendations for the UMS package products.

Ordering Information

Chip form: CHP1102-98F

Information furnished is believed to be accurate and reliable. However **United Monolithic Semiconductors S.A.S.** assumes no responsibility for the consequences of use of such information nor for any infringement of patents or other rights of third parties which may result from its use. No license is granted by implication or otherwise under any patent or patent rights of **United Monolithic Semiconductors S.A.S.**. Specifications mentioned in this publication are subject to change without notice. This publication supersedes and replaces all information previously supplied. **United Monolithic Semiconductors S.A.S.** products are not authorised for use as critical components in life support devices or systems without express written approval from **United Monolithic Semiconductors S.A.S.**