



REV A January 2011

Oscilent Controlled Document

Ordering Code / Part Number	Product Description
835-IF44.0M-06A	44.0MHz IF SAW Filter 6.49 MHz Bandwidth

### Specification Contents

- o Mechanical Dimensions
- o Test Circuit
- o Maximum Ratings
- o Electrical Specification
- o Frequency Response
- o Smith Chart
- o SWR

### Notes

- o Electrostatic Sensitive Device (ESD) 
- o Avoid excessive ultrasonic exposure
- o Solderability compatible with JEDEC J-STD-020C Pb-free process, 260°C peak reflow temperature
- o This product complies with EU directive 2002/95/EC (RoHS compliance)





### Mechanical Dimensions (mm)

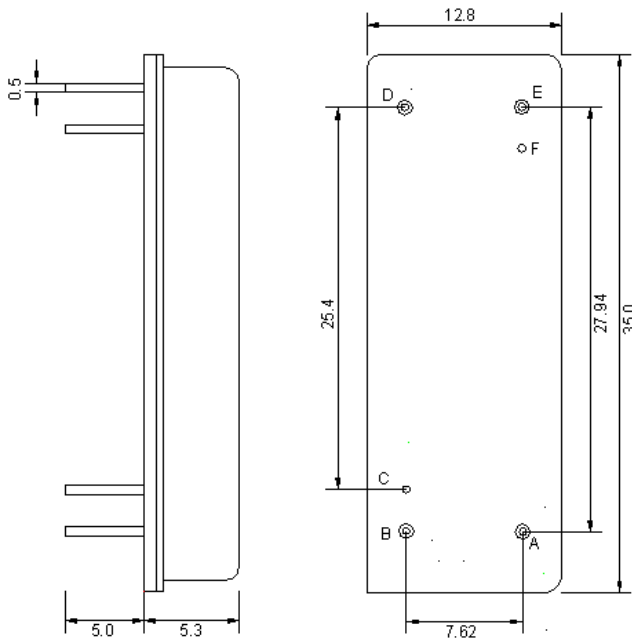

Pin Description	
B, C, D, F	Ground
A	In
E	Out

### Test Circuit

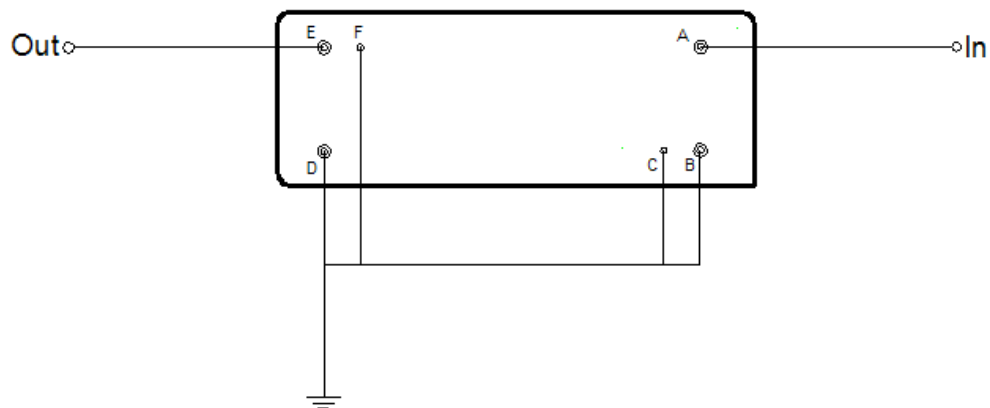

**Source & Load Impedance: 50  $\Omega$**



## Maximum Ratings

Parameters Description	Unit	Minimum	Typical	Maximum
Operating Temperature Range	°C	-30	-	80
Storage Temperature Range	°C	-40	-	85
Maximum DC Voltage	V	-	-	10
Maximum Input Power	dBm	-	-	10
Source Impedance (single ended) <sup>(1)</sup>	Ω	-	50	-
Load Impedance (single ended) <sup>(1)</sup>	Ω	-	50	-

Notes: With Matching Network (Ref. Testing Environment Circuit as shown above).

Those impedances could be modified with different impedance values and/or structures, if necessary.

## Electrical Specification

Parameters Description	Unit	Minimum	Typical	Maximum
Center Frequency (Fo)	MHz	-	44.0	-
Insertion Loss at Fo	dB	-	25.90	28.00
Group Delay Variation (Fo±3.00MHz)	ns	-	50	90
Absolute Delay Time at Fo	us	-	2.67	-
Amplitude Ripple (Fo±3.00MHz)	dB	-	0.40	0.90
Bandwidth at -1dB	MHz	6.30	6.49	-
Bandwidth at -3dB	MHz	-	6.84	-
Bandwidth at -40dB	MHz	-	8.21	8.40
Bandwidth at -50dB	MHz	-	8.34	8.50
Relative Attenuation				
Lower Sidelobe	dB	50	55	-
Upper Sidelobe	dB	50	55	-
Temperature Coefficient	ppm/°C	-	-94	-



January 2011 Rev A

Oscilent Part Number  
**835-IF44.0M-06A**

44.0MHz IF SAW Filter 6.49 MHz Bandwidth

## Frequency Response

### Bandwidth at -1.0 dB

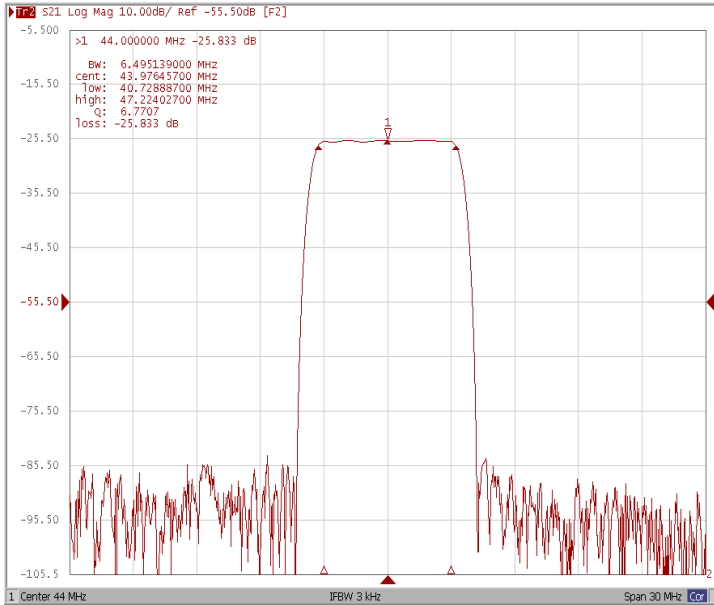

### Bandwidth at -3.0 dB

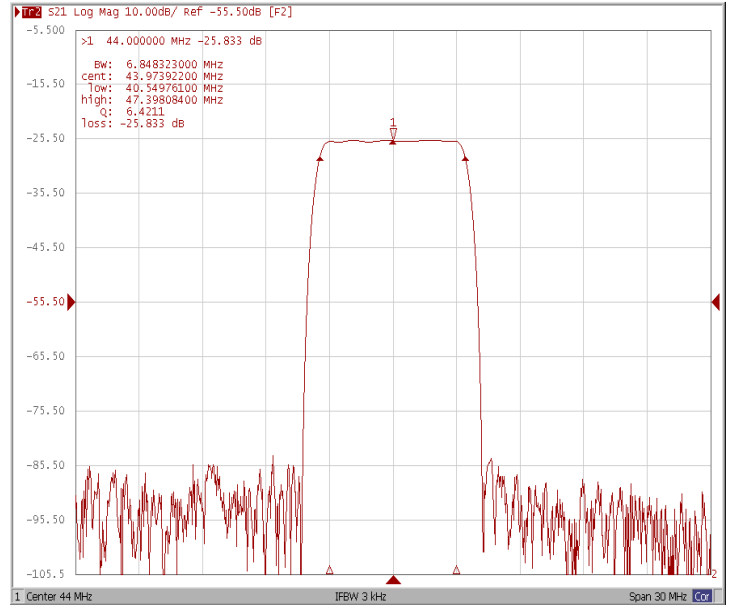

### Bandwidth at -40.0 dB

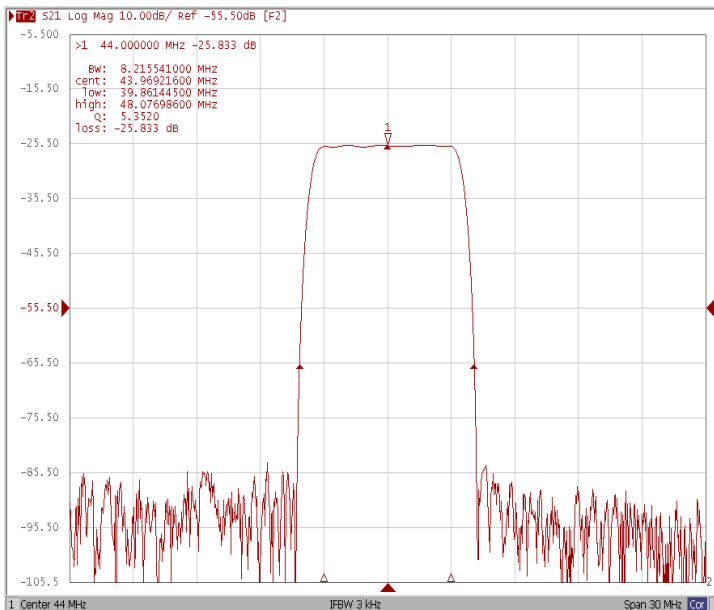

### Bandwidth at -50.0 dB

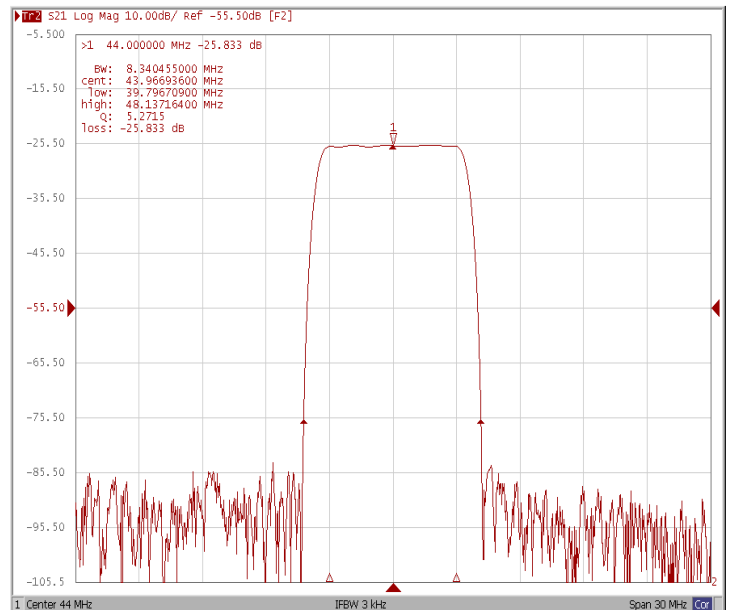



### Ripple Variation Fo±3.00MHz



### Group Delay Variation Fo±3.00MHz

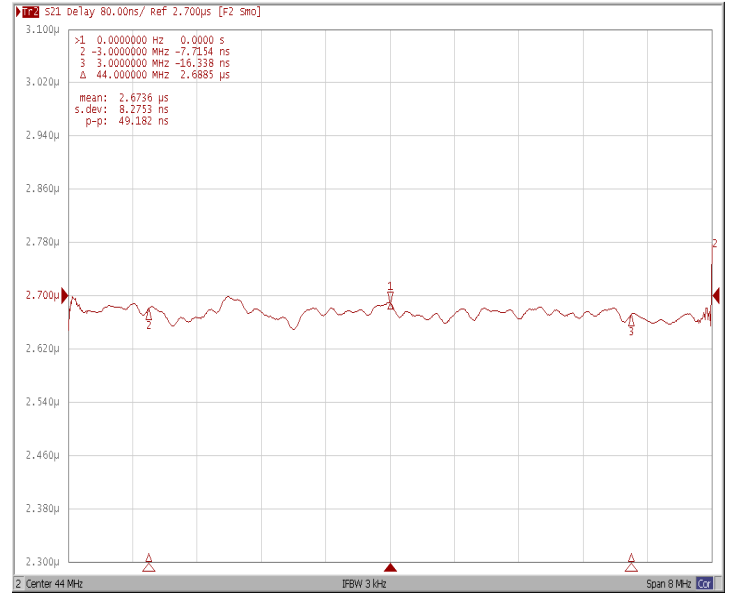

### Smith Chart

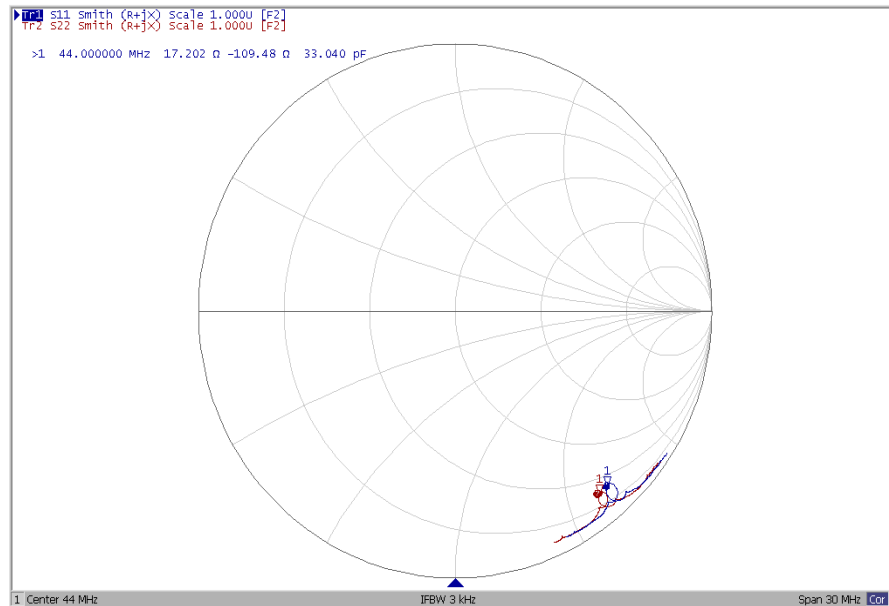



## SWR

