



# LBV320-XXTGD-RANX00700

LBV300

LEVEL SENSORS

**SICK**  
Sensor Intelligence.



Illustration may differ



### Ordering information

Type	Part no.
LBV320-XXTGDRANX00700	6038343

Other models and accessories → [www.sick.com/LBV300](http://www.sick.com/LBV300)

### Detailed technical data

#### Features

<b>Medium</b>	Bulk solids
<b>Measurement</b>	Switch
<b>Probe length</b>	700 mm
<b>Process pressure</b>	-1 bar ... 6 bar
<b>Process temperature</b>	-20 °C ... +80 °C
<b>Fill material density</b>	≥ 0.008
<b>Particle size</b>	< 10 mm
<b>Tensile strength</b>	≤ 3,000 N

#### Performance

<b>Accuracy of sensor element</b>	± 10 mm
<b>Repeatability</b>	≤ 5 mm
<b>Response time</b>	500 ms when covered / 1,000 ms when uncovered

#### Electronics

<b>Power consumption</b>	5 mA ... 30 mA
<b>Initialization time</b>	< 2 s
<b>VDE protection class 1</b>	✓
<b>Electrical connection</b>	½" NPT
<b>Supply voltage</b>	Double relay (DPDT): 20 V DC ... 72 V DC / 20 V AC ... 253 V AC
<b>Hysteresis</b>	10 mm
<b>Output current</b>	> 10 µA; < 3A AC, 1A DC
<b>Inductive load</b>	750 VA 54 W
<b>Capacitive load</b>	750 VA 54 W
<b>Contact load</b>	Min. 50 mW / max. 750 VA, 54 W
<b>Enclosure rating</b>	IP 66 / IP 67

#### Mechanics

<b>Process connection</b>	G 1½ A PN 25
<b>Housing material</b>	Aluminum

<b>Sensor material</b>	Stainless steel 316L, 318LN, PUR
------------------------	----------------------------------

## Ambient data

<b>Ambient operating temperature</b>	-40 °C ... +80 °C
<b>Ambient storage temperature</b>	-40 °C ... +80 °C

## Classifications

<b>ECl@ss 5.0</b>	27273202
<b>ECl@ss 5.1.4</b>	27273202
<b>ECl@ss 6.0</b>	27273202
<b>ECl@ss 6.2</b>	27273202
<b>ECl@ss 7.0</b>	27273202
<b>ECl@ss 8.0</b>	27273202
<b>ECl@ss 8.1</b>	27273202
<b>ECl@ss 9.0</b>	27273202
<b>ETIM 5.0</b>	EC002654
<b>ETIM 6.0</b>	EC002654
<b>UNSPSC 16.0901</b>	41111938

## Dimensional drawing (Dimensions in mm (inch))

Temperature adapter

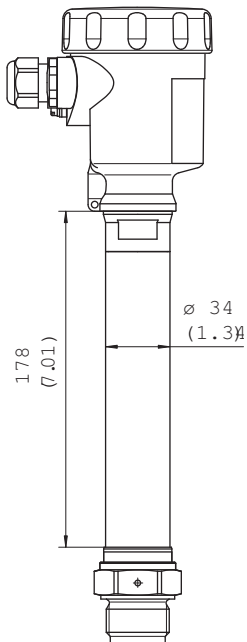

LBV320 with PUR suspension cable, threaded version G 1½ A (DIN ISO 228/1)

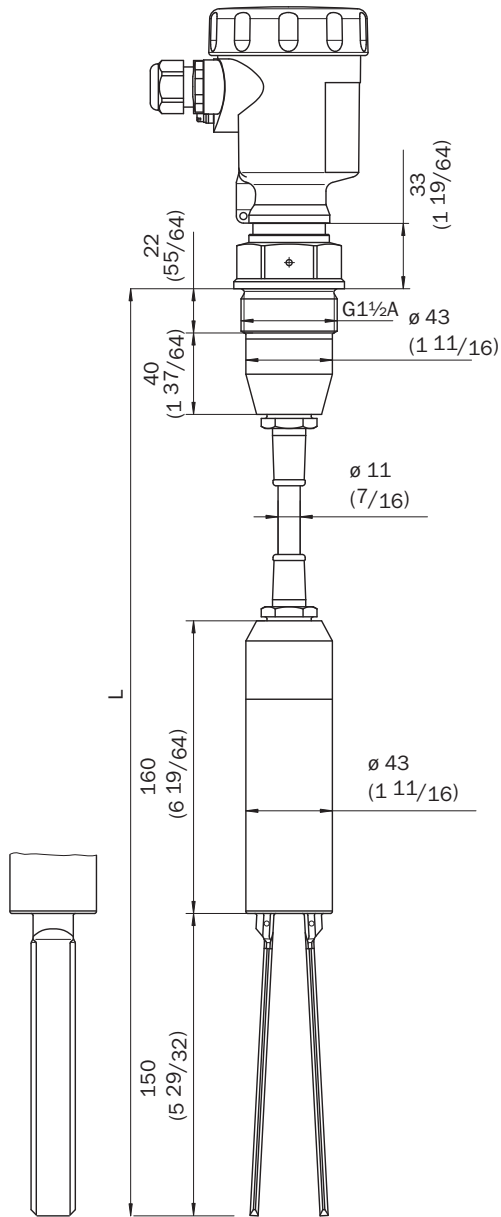

### Connection diagram

Double relay connection diagram

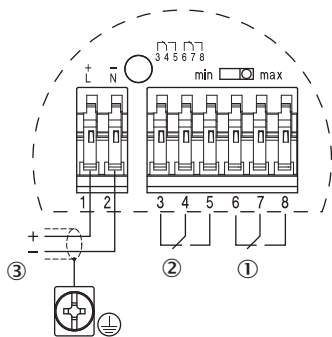

- ① Relay output
- ② Relay output
- ③ Power supply

### Instruction for installation

Horizontal mounting

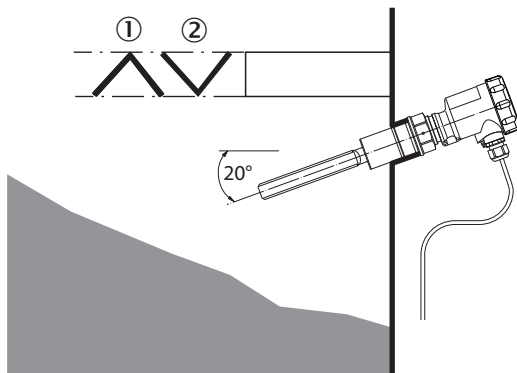

- ① Protective sheet
- ② Concave protective sheet for abrasive solids

### Recommended accessories

Other models and accessories → [www.sick.com/LBV300](http://www.sick.com/LBV300)

	Brief description	Type	Part no.
<b>Mounting brackets and mounting plates</b>			
	Locking screw connection, process pressure –1 bar to 16 bar, process connection G 2 A, inner thread G 1 1/2 A, stainless steel 316L	BEF-MU-316G20-ALBV	5322462
<b>Electronic modules</b>			
	Double relay (DPDT): 20 V DC ... 72 V DC / 20 ... 250 V AC	ECD-RE-LB-VREL-0001	6038666

## SICK AT A GLANCE

SICK is one of the leading manufacturers of intelligent sensors and sensor solutions for industrial applications. A unique range of products and services creates the perfect basis for controlling processes securely and efficiently, protecting individuals from accidents and preventing damage to the environment.

We have extensive experience in a wide range of industries and understand their processes and requirements. With intelligent sensors, we can deliver exactly what our customers need. In application centers in Europe, Asia and North America, system solutions are tested and optimized in accordance with customer specifications. All this makes us a reliable supplier and development partner.

Comprehensive services complete our offering: SICK LifeTime Services provide support throughout the machine life cycle and ensure safety and productivity.

For us, that is “Sensor Intelligence.”

## WORLDWIDE PRESENCE:

Contacts and other locations –[www.sick.com](http://www.sick.com)