

## Features

- $I_{T(RMS)}$  : 3 A
- $V_{DRM}$  : 600 V
- $I_{FGTI}, I_{RGTI}, I_{RGTIII}$  : 20 mA (10 mA)<sup>Note5</sup>
- $V_{ISO}$  : 2000 V
- The product guaranteed maximum junction temperature of 150°C.
- Insulated Type
- Planar Passivation Type
- Refer to the recommended circuit values around the triac before using.

## Outline

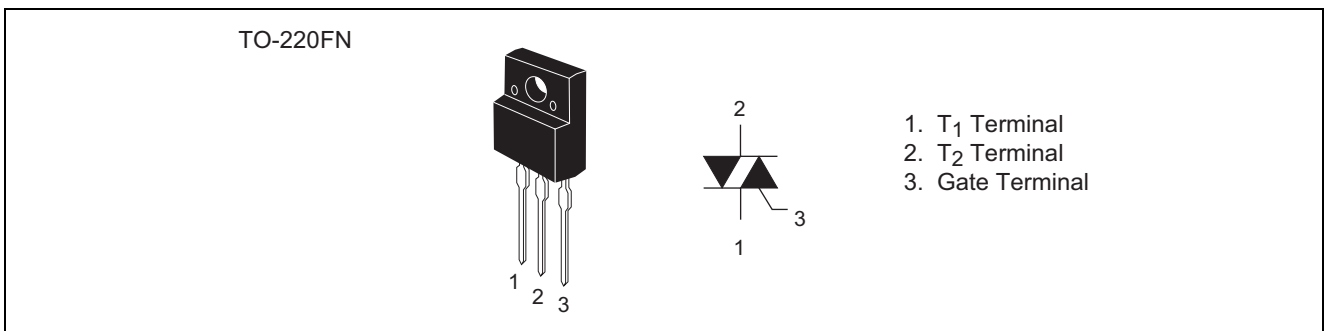

## Applications

Switching mode power supply, small motor control, heater control, solenoid driver, and other general purpose control applications

## Maximum Ratings

Parameter	Symbol	Voltage class	Unit
		12	
Repetitive peak off-state voltage <sup>Note1</sup>	$V_{DRM}$	600	V
Non-repetitive peak off-state voltage <sup>Note1</sup>	$V_{DSM}$	720	V

Parameter	Symbol	Ratings	Unit	Conditions
RMS on-state current	$I_T (RMS)$	3	A	Commercial frequency, sine full wave 360° conduction, $T_c = 134^\circ C$
Surge on-state current	$I_{TSM}$	30	A	60Hz sinewave 1 full cycle, peak value, non-repetitive
$I^2t$ for fusing	$I^2t$	3.7	$A^2s$	Value corresponding to 1 cycle of half wave 60Hz, surge on-state current
Peak gate power dissipation	$P_{GM}$	3	W	
Average gate power dissipation	$P_{G(AV)}$	0.3	W	
Peak gate voltage	$V_{GM}$	6	V	
Peak gate current	$I_{GM}$	0.5	A	
Junction temperature	$T_j$	- 40 to +150	$^\circ C$	
Storage temperature	$T_{stg}$	- 40 to +150	$^\circ C$	
Mass	—	2.0	g	Typical value
Isolation voltage	Viso	2000	V	$T_a = 25^\circ C$ , AC 1 minute, $T_1 \cdot T_2 \cdot G$ terminal to case

Notes: 1. Gate open.

**Electrical Characteristics**

Parameter	Symbol	Min.	Typ.	Max.	Unit	Test conditions	
Repetitive peak off-state current	$I_{DRM}$	—	—	2.0	mA	$T_j = 150^\circ C$ , $V_{DRM}$ applied	
On-state voltage	$V_{TM}$	—	—	1.5	V	$T_c = 25^\circ C$ , $I_{TM} = 4.5 A$ , Instantaneous measurement	
Gate trigger voltage <sup>Note2</sup>	I	$V_{FGTI}$	—	—	1.5	V	$T_j = 25^\circ C$ , $V_D = 6 V$ , $R_L = 6 \Omega$ , $R_G = 330 \Omega$
	II	$V_{RGTI}$	—	—	1.5	V	
	III	$V_{RGTIII}$	—	—	1.5	V	
Gate trigger current <sup>Note2</sup>	I	$I_{FGTI}$	—	—	20 <sup>Note5</sup>	mA	$T_j = 25^\circ C$ , $V_D = 6 V$ , $R_L = 6 \Omega$ , $R_G = 330 \Omega$
	II	$I_{RGTI}$	—	—	20 <sup>Note5</sup>	mA	
	III	$I_{RGTIII}$	—	—	20 <sup>Note5</sup>	mA	
Gate non-trigger voltage	$V_{GD}$	0.2/0.1	—	—	V	$T_j = 125^\circ C/150^\circ C$ , $V_D = 1/2 V_{DRM}$	
Thermal resistance	$R_{th(j-c)}$	—	—	4.0	$^\circ C/W$	Junction to case <sup>Note3</sup>	
Critical-rate of rise of off-state commutating voltage <sup>Note4</sup>	$(dv/dt)_c$	5/1	—	—	$V/\mu s$	$T_j = 125^\circ C/150^\circ C$	

Notes: 2. Measurement using the gate trigger characteristics measurement circuit.

3. The contact thermal resistance  $R_{th(c-f)}$  in case of greasing is  $0.5^\circ C/W$ .

4. Test conditions of the critical-rate of rise of off-state commutating voltage is shown in the table below.

5. High sensitivity ( $I_{GT} \leq 10 mA$ ) is also available. ( $I_{GT}$  item: 1)

Test conditions	Commutating voltage and current waveforms (inductive load)
1. Junction temperature $T_j = 125^\circ C/150^\circ C$ 2. Rate of decay of on-state commutating current $(di/dt)_c = -1.5 A/ms$ 3. Peak off-state voltage $V_D = 400 V$	

Performance Curves

Maximum On-State Characteristics

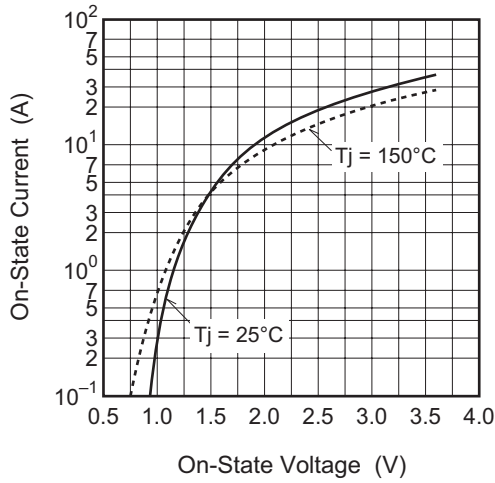

Rated Surge On-State Current

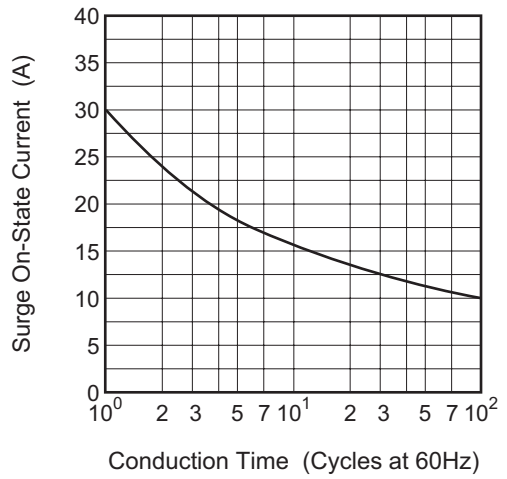

Gate Characteristics (I, II and III)

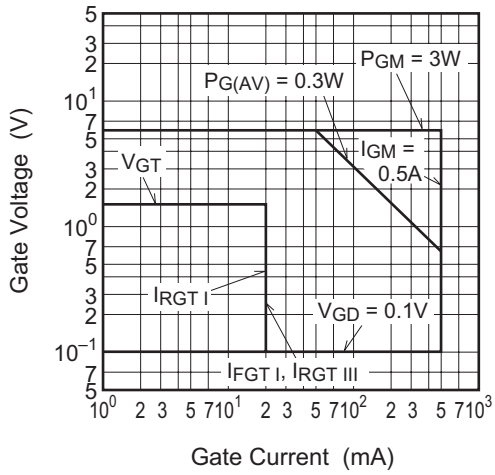

Gate Trigger Current vs. Junction Temperature

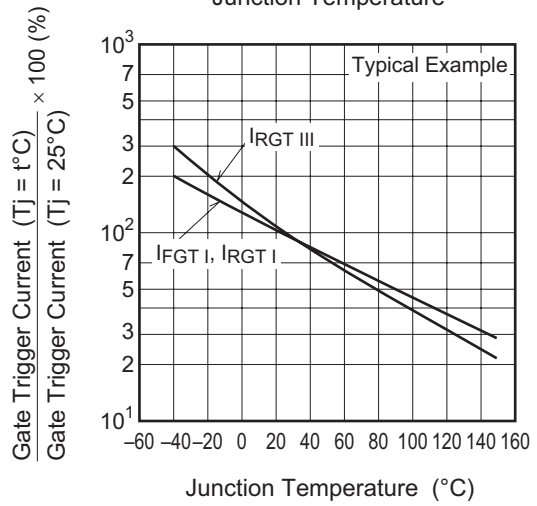

Gate Trigger Voltage vs. Junction Temperature

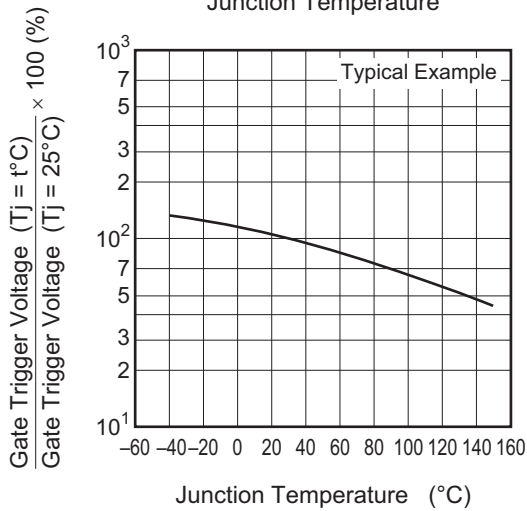

Maximum Transient Thermal Impedance Characteristics (Junction to case)

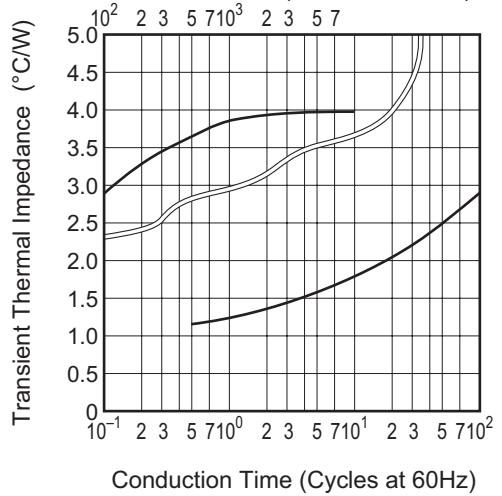

Maximum Transient Thermal Impedance Characteristics (Junction to ambient)

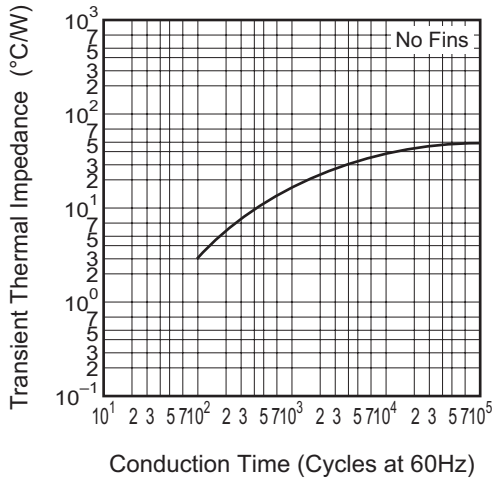

Maximum On-State Power Dissipation

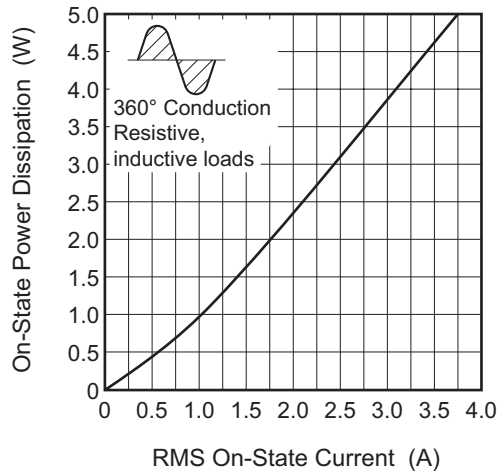

Allowable Case Temperature vs. RMS On-State Current

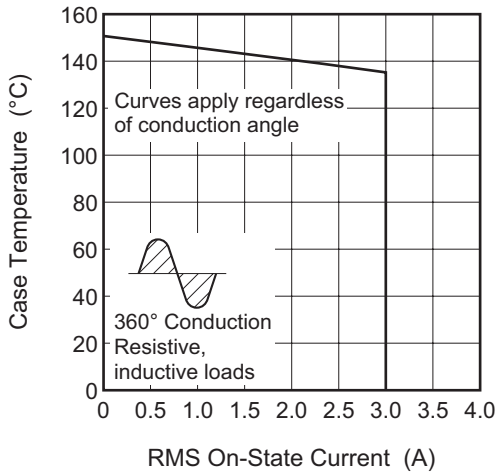

Allowable Ambient Temperature vs. RMS On-State Current

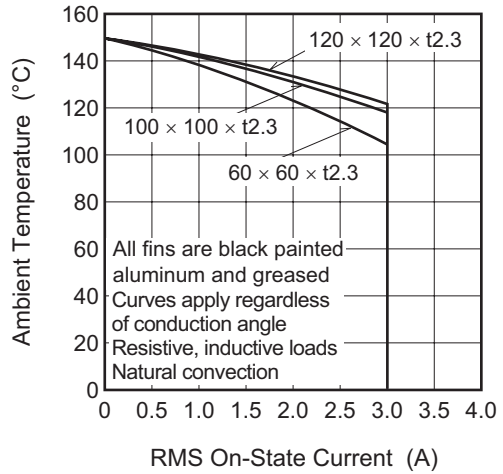

Allowable Ambient Temperature vs. RMS On-State Current

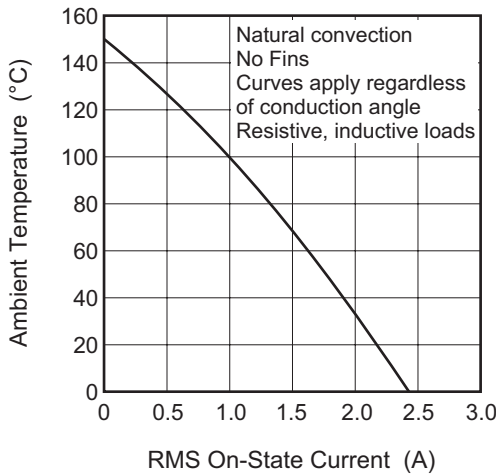

Repetitive Peak Off-State Current vs. Junction Temperature

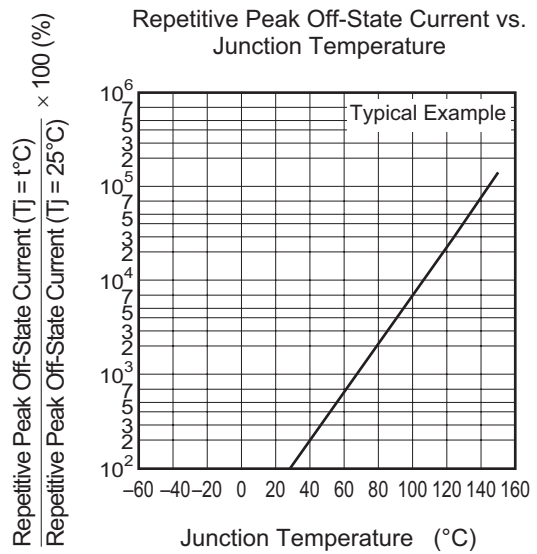

Holding Current vs. Junction Temperature

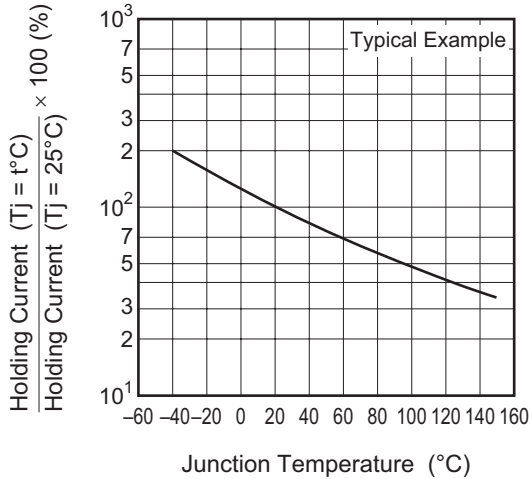

Latching Current vs. Junction Temperature

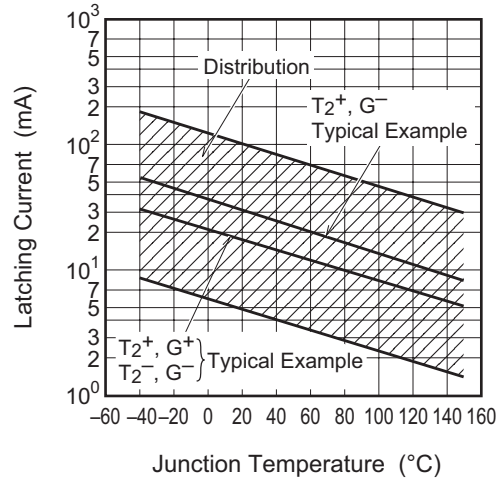

Breakover Voltage vs. Junction Temperature

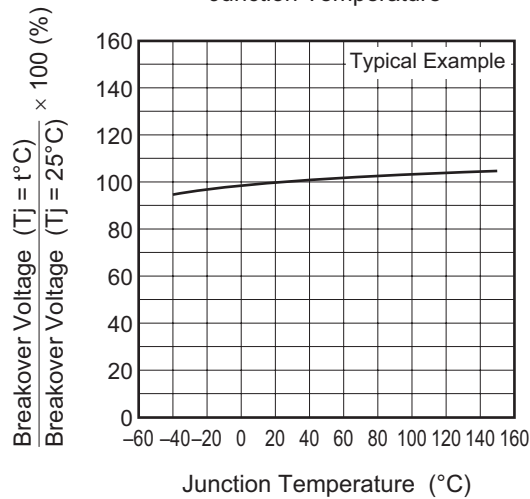

Breakover Voltage vs. Rate of Rise of Off-State Voltage (Tj=125°C)

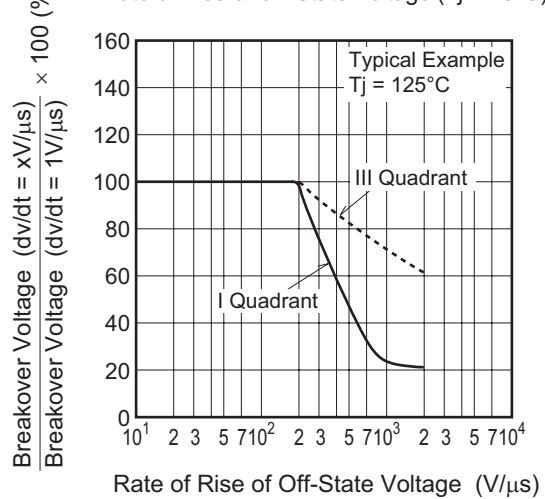

Breakover Voltage vs. Rate of Rise of Off-State Voltage (Tj=150°C)

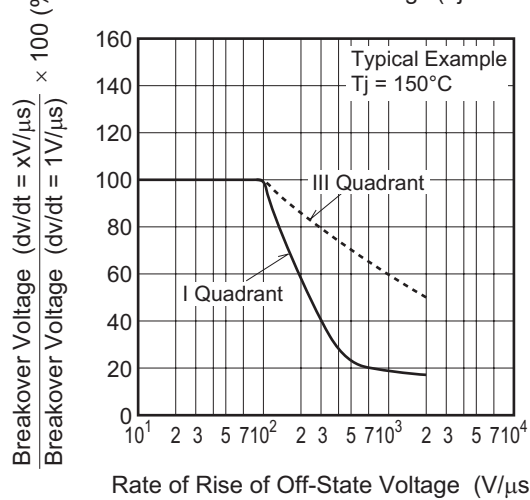

Commutation Characteristics (Tj=125°C)

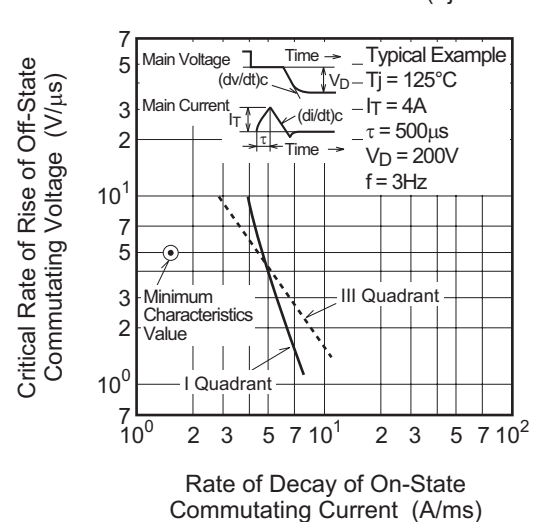

Commutation Characteristics (Tj=150°C)

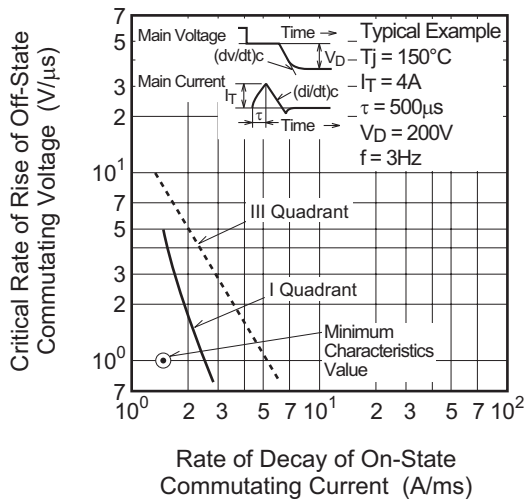

Gate Trigger Current vs. Gate Current Pulse Width

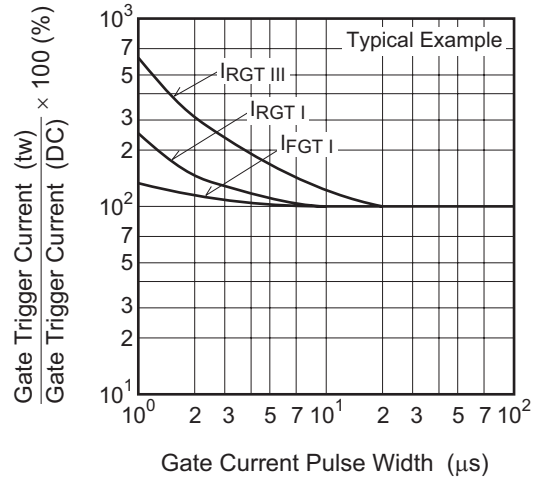

Gate Trigger Characteristics Test Circuits

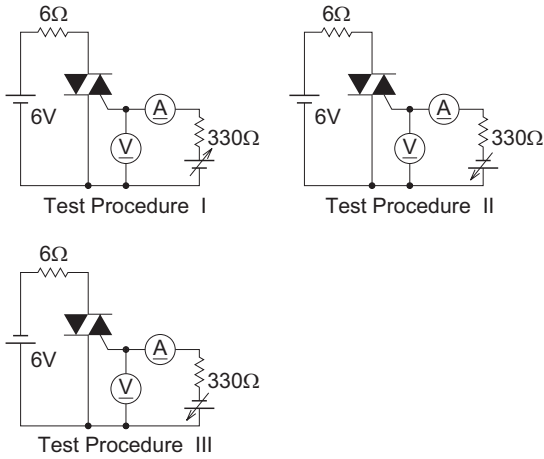

Recommended Circuit Values Around The Triac

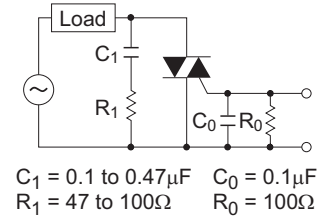

### Package Dimensions

**TO-220FN**

EIAJ Package Code	JEDEC Code	Mass (g) (reference value)	Lead Material
—	—	2.0	Cu alloy

Technical drawings showing dimensions for TO-220FN package:

- Top view: Overall width  $10 \pm 0.3$ , distance from top edge to mounting hole  $3 \pm 0.3$ , mounting hole diameter  $\phi 3.2 \pm 0.2$ , distance from mounting hole to lead start  $6.5 \pm 0.3$ , lead spacing  $1.1 \pm 0.2$ , lead thickness  $0.75 \pm 0.15$ , lead length  $14 \pm 0.5$ , lead width  $3.6 \pm 0.3$ , distance from bottom edge to lead start  $2.54 \pm 0.25$ .
- Side view: Lead diameter  $2.8 \pm 0.2$ , lead length  $0.75 \pm 0.15$ .
- Lead view: Lead diameter  $2.6 \pm 0.2$ , lead length  $4.5 \pm 0.2$ .

Note 1) The dimensional figures indicate representative values unless otherwise the tolerance is specified.

Symbol	Dimension in Millimeters		
	Min	Typ	Max
A	—	—	—
A <sub>1</sub>	—	—	—
A <sub>2</sub>	—	—	—
b	—	—	—
D	—	—	—
E	—	—	—
e	—	—	—
x	—	—	—
y	—	—	—
y <sub>1</sub>	—	—	—
ZD	—	—	—
ZE	—	—	—

### Order Code

Lead form	Standard packing	Quantity	Standard order code	Standard order code example
Straight type	Plastic Magazine (Tube)	50	Type name	BCR3KM-12LB
Lead form	Plastic Magazine (Tube)	50	Type name – Lead forming code	BCR3KM-12LB-A8

Note : Please confirm the specification about the shipping in detail.