

COMPLEMENTARY PAIR ENHANCEMENT MODE MOSFET

Product Summary

Device	V _{(BR)DSS}	R _{DS(ON)} max	I _D MAX T _A = +25°C
Q1 N-Channel	12V	29mΩ @ V _{GS} = 4.5V	5.6A
		34mΩ @ V _{GS} = 2.5V	5.1A
		44mΩ @ V _{GS} = 1.8V	4.5A
		65mΩ @ V _{GS} = 1.5V	3.7A
Q2 P-Channel	-12V	61mΩ @ V _{GS} = -4.5V	-3.8A
		81mΩ @ V _{GS} = -2.5V	-3.3A
		115mΩ @ V _{GS} = -1.8V	-2.8A
		210mΩ @ V _{GS} = -1.5V	-2.3A

Description

This MOSFET has been designed to minimize the on-state resistance (R_{DS(ON)}) and yet maintain superior switching performance, making it ideal for high efficiency power management applications.

Applications

- Load Switch
- Power Management Functions
- Portable Power Adaptors

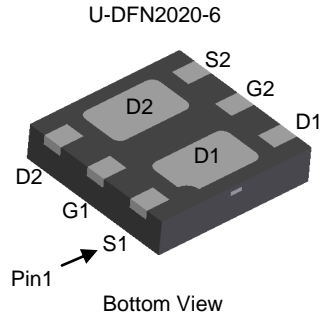

Features

- Low On-Resistance
- Low Input Capacitance
- Low Profile, 0.6mm Max Height
- **Totally Lead-Free & Fully RoHS Compliant (Notes 1 & 2)**
- **Halogen and Antimony Free. "Green" Device (Note 3)**

Mechanical Data

- Case: U-DFN2020-6
- Case Material: Molded Plastic, "Green" Molding Compound. UL Flammability Classification Rating 94V-0
- Moisture Sensitivity: Level 1 per J-STD-020
- Terminals: Finish NiPdAu over Copper Leadframe. Solderable per MIL-STD-202, Method 208 
- Terminals Connections: See Diagram Below
- Weight: 0.0065 grams (Approximate)

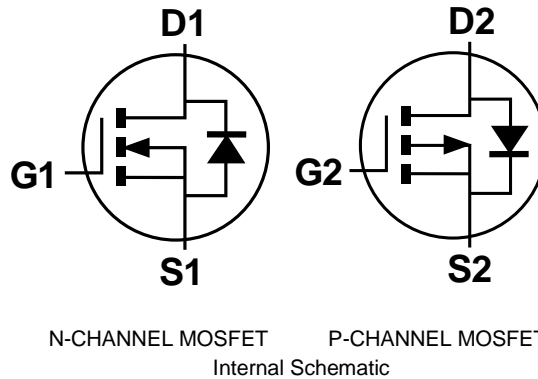

Ordering Information (Note 4)

Part Number	Case	Packaging
DMC1029UFDB -7	U-DFN2020-6	3000/Tape & Reel
DMC1029UFDB -13	U-DFN2020-6	10000/Tape & Reel

- Notes:
1. No purposely added lead. Fully EU Directive 2002/95/EC (RoHS) & 2011/65/EU (RoHS 2) compliant.
 2. See http://www.diodes.com/quality/lead_free.html for more information about Diodes Incorporated's definitions of Halogen- and Antimony-free, "Green" and Lead-free.
 3. Halogen- and Antimony-free "Green" products are defined as those which contain <900ppm bromine, <900ppm chlorine (<1500ppm total Br + Cl) and <1000ppm antimony compounds.
 4. For packaging details, go to our website at <http://www.diodes.com/products/packages.html>

Marking Information

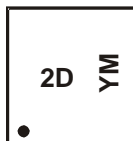

2D = Product Type Marking Code
 YM = Date Code Marking
 Y = Year (ex: B = 2014)
 M = Month (ex: 9 = September)

Date Code Key

Year	2014	2015	2016	2017	2018	2019	2020
Code	B	C	D	E	F	G	H

Month	Jan	Feb	Mar	Apr	May	Jun	Jul	Aug	Sep	Oct	Nov	Dec
Code	1	2	3	4	5	6	7	8	9	O	N	D

Maximum Ratings (@T_A = +25°C, unless otherwise specified.)

Characteristic			Symbol	Q1 N-CHANNEL	Q2 P-CHANNEL	Units
Drain-Source Voltage			V _{DSS}	12	-12	V
Gate-Source Voltage			V _{GSS}	±8	±8	V
Continuous Drain Current (Note 5) V _{GS} = 4.5V	Steady State	T _A = +25°C T _A = +70°C	I _D	5.6 4.4	-3.8 -3.0	A
	t < 5s	T _A = +25°C T _A = +70°C	I _D	7.2 5.8	-5.0 -4.0	A
Maximum Continuous Body Diode Forward Current (Note 5)			I _S	1	-1	A
Pulsed Drain Current (10µs Pulse, Duty Cycle = 1%)			I _{DM}	20	-15	A
Avalanche Current (L = 0.1mH)			I _{AS}	15	-12	A
Avalanche Energy (L = 0.1mH)			E _{AS}	12	8	mJ

Thermal Characteristics

Characteristic		Symbol	Value	Units
Total Power Dissipation (Note 5)	Steady State	P _D	1.4	W
	t < 5s		2.2	
Thermal Resistance, Junction to Ambient (Note 5)	Steady State	R _{θJA}	91	°C/W
	t < 5s		55	
Thermal Resistance, Junction to Case		R _{θJC}	20	
Operating and Storage Temperature Range		T _J , T _{STG}	-55 to +150	°C

Note: 5. Device mounted on 1" x 1" FR-4 PCB with high coverage 2oz. Copper, single sided.

Electrical Characteristics Q1 N-CHANNEL (@T_A = +25°C, unless otherwise specified.)

Characteristic	Symbol	Min	Typ	Max	Unit	Test Condition
OFF CHARACTERISTICS (Note 6)						
Drain-Source Breakdown Voltage	BV _{DSS}	12	—	—	V	V _{GS} = 0V, I _D = 250μA
Zero Gate Voltage Drain Current T _J = +25°C	I _{DSS}	—	—	1.0	μA	V _{DS} = 12V, V _{GS} = 0V
Gate-Source Leakage	I _{GSS}	—	—	±100	nA	V _{GS} = ±8V, V _{DS} = 0V
ON CHARACTERISTICS (Note 6)						
Gate Threshold Voltage	V _{GS(TH)}	0.4	—	1	V	V _{DS} = V _{GS} , I _D = 250μA
Static Drain-Source On-Resistance	R _{DS(ON)}	—	17	29	mΩ	V _{GS} = 4.5V, I _D = 5A
		—	20	34		V _{GS} = 2.5V, I _D = 4.6A
		—	24	44		V _{GS} = 1.8V, I _D = 4.1A
		—	30	65		V _{GS} = 1.5V, I _D = 2A
Diode Forward Voltage	V _{SD}	—	0.6	1.2	V	V _{GS} = 0V, I _S = 1A
DYNAMIC CHARACTERISTICS (Note 7)						
Input Capacitance	C _{iss}	—	914	—	pF	V _{DS} = 6V, V _{GS} = 0V, f = 1.0MHz
Output Capacitance	C _{oss}	—	132	—	pF	
Reverse Transfer Capacitance	C _{rss}	—	119	—	pF	V _{DS} = 0V, V _{GS} = 0V, f = 1MHz
Gate Resistance	R _g	—	1.26	—	Ω	
Total Gate Charge (V _{GS} = 4.5V)	Q _g	—	10.5	—	nC	V _{DS} = 6V, I _D = 6.5A
Total Gate Charge (V _{GS} = 8V)		—	19.6	—	nC	
Gate-Source Charge	Q _{gs}	—	1.2	—	nC	
Gate-Drain Charge	Q _{gd}	—	1.6	—	nC	
Turn-On Delay Time	t _{D(ON)}	—	5.0	—	ns	
Turn-On Rise Time	t _r	—	10.5	—	ns	V _{DD} = 6V, V _{GS} = 4.5V, R _L = 1.2Ω, R _G = 1Ω
Turn-Off Delay Time	t _{D(OFF)}	—	16.6	—	ns	
Turn-Off Fall Time	t _f	—	4.1	—	ns	

Electrical Characteristics Q2 P-CHANNEL (@T_A = +25°C, unless otherwise specified.)

Characteristic	Symbol	Min	Typ	Max	Unit	Test Condition
OFF CHARACTERISTICS (Note 6)						
Drain-Source Breakdown Voltage	BV _{DSS}	-12	—	—	V	V _{GS} = 0V, I _D = -250μA
Zero Gate Voltage Drain Current T _J = +25°C	I _{DSS}	—	—	-1.0	μA	V _{DS} = -12V, V _{GS} = 0V
Gate-Source Leakage	I _{GSS}	—	—	±100	nA	V _{GS} = ±8V, V _{DS} = 0V
ON CHARACTERISTICS (Note 6)						
Gate Threshold Voltage	V _{GS(TH)}	-0.4	—	-1	V	V _{DS} = V _{GS} , I _D = -250μA
Static Drain-Source On-Resistance	R _{DS(ON)}	—	37	61	mΩ	V _{GS} = -4.5V, I _D = -3.6A
		—	47	81		V _{GS} = -2.5V, I _D = -3.2A
		—	63	115		V _{GS} = -1.8V, I _D = -1A
		—	90	210		V _{GS} = -1.5V, I _D = -1A
Diode Forward Voltage	V _{SD}	—	-0.65	-1.2	V	V _{GS} = 0V, I _S = -1A
DYNAMIC CHARACTERISTICS (Note 7)						
Input Capacitance	C _{iss}	—	915	—	pF	V _{DS} = -6V, V _{GS} = 0V, f = 1.0MHz
Output Capacitance	C _{oss}	—	225	—	pF	
Reverse Transfer Capacitance	C _{rss}	—	183	—	pF	V _{DS} = 0V, V _{GS} = 0V, f = 1MHz
Gate Resistance	R _g	—	56.9	—	Ω	
Total Gate Charge (V _{GS} = -4.5V)	Q _g	—	10.7	—	nC	V _{DS} = -6V, I _D = -4.3A
Total Gate Charge (V _{GS} = -8V)		—	17.9	—	nC	
Gate-Source Charge	Q _{gs}	—	1.7	—	nC	
Gate-Drain Charge	Q _{gd}	—	3.0	—	nC	
Turn-On Delay Time	t _{D(ON)}	—	5.7	—	ns	
Turn-On Rise Time	t _r	—	11.5	—	ns	V _{DD} = -6V, V _{GS} = -4.5V, R _L = 1.6Ω, R _G = 1Ω
Turn-Off Delay Time	t _{D(OFF)}	—	27.8	—	ns	
Turn-Off Fall Time	t _f	—	26.4	—	ns	

Notes: 6. Short duration pulse test used to minimize self-heating effect.
7. Guaranteed by design. Not subject to product testing.

Typical Characteristics - N-CHANNEL

NEW PRODUCT

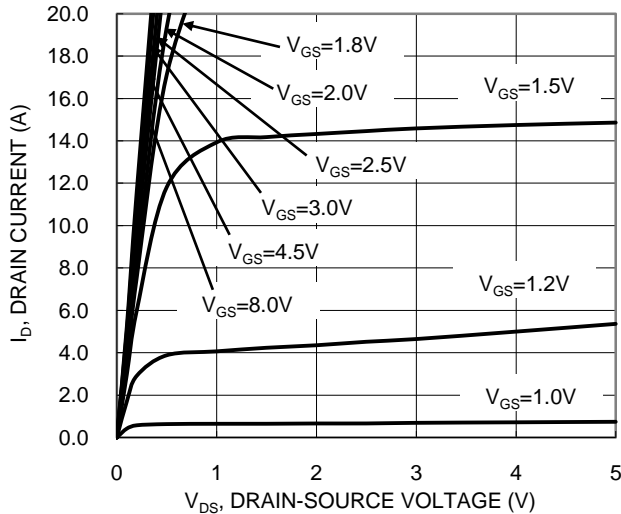

Figure 1. Typical Output Characteristic

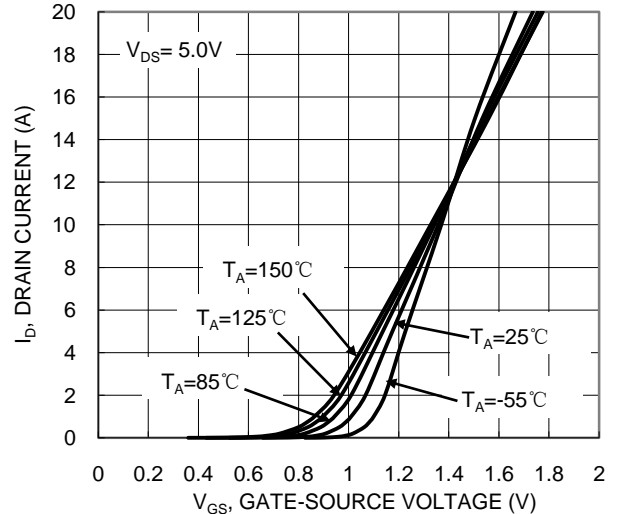

Figure 2. Typical Transfer Characteristic

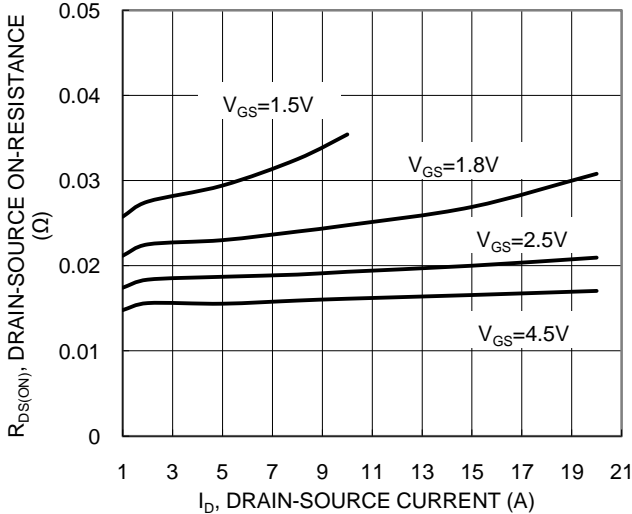

Figure 3. Typical On-Resistance vs. Drain Current and Gate Voltage

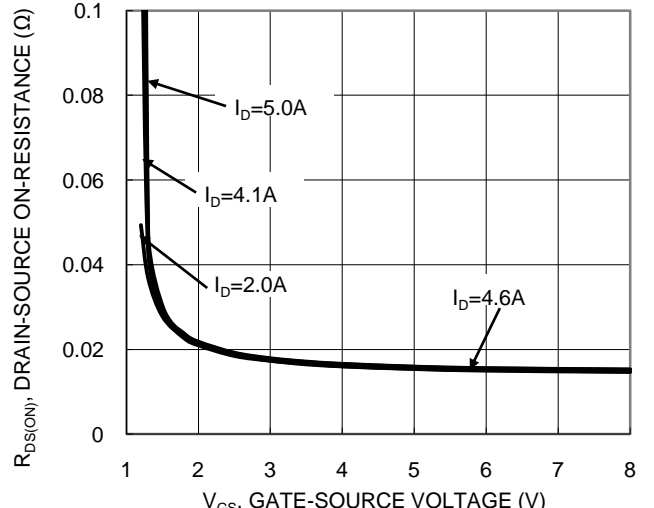

Figure 4. Typical Transfer Characteristic

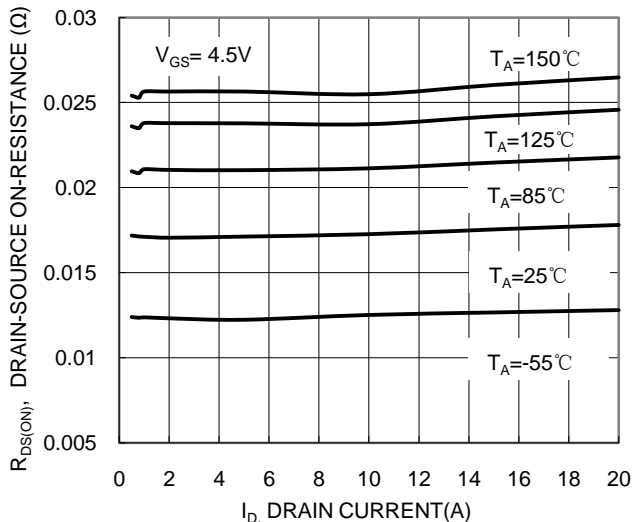

Figure 5. Typical On-Resistance vs. Drain Current and Temperature

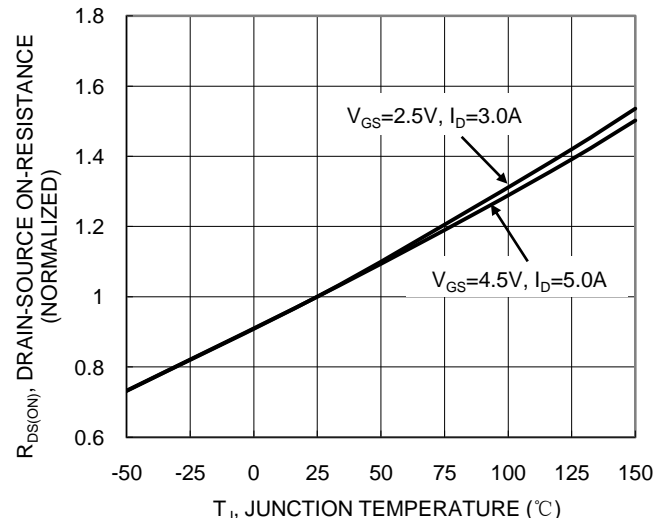

Figure 6. On-Resistance Variation with Temperature

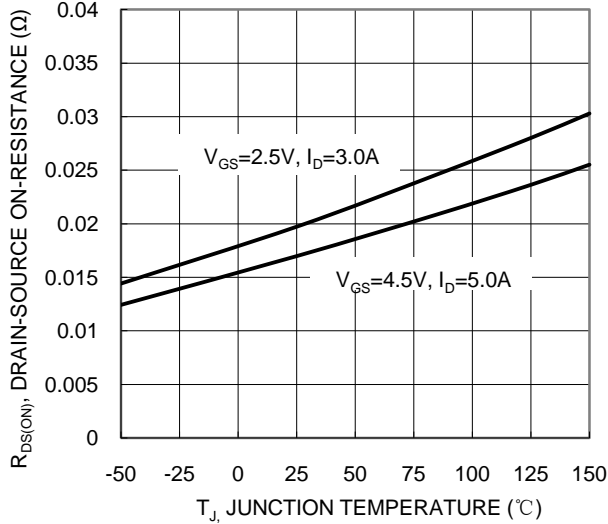

Figure 7. On-Resistance Variation with Temperature

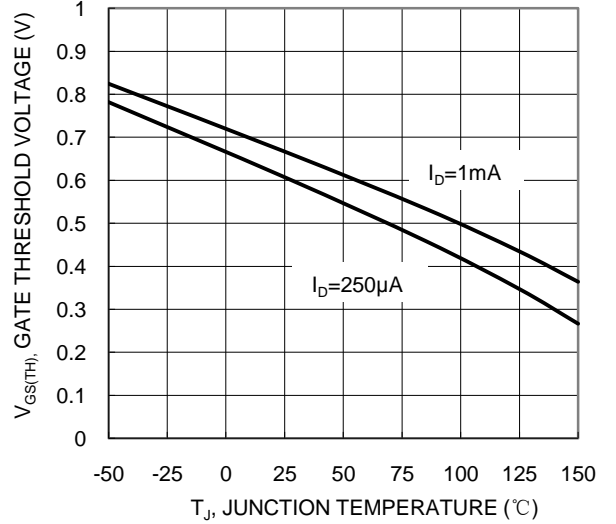

Figure 8. Gate Threshold Variation vs. Junction Temperature

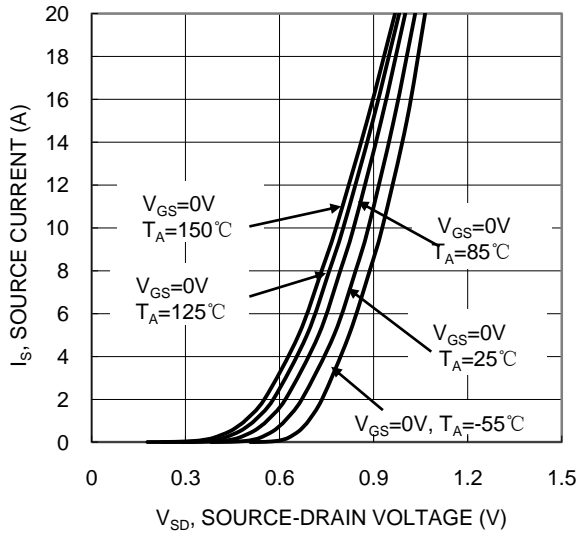

Figure 9. Diode Forward Voltage vs. Current

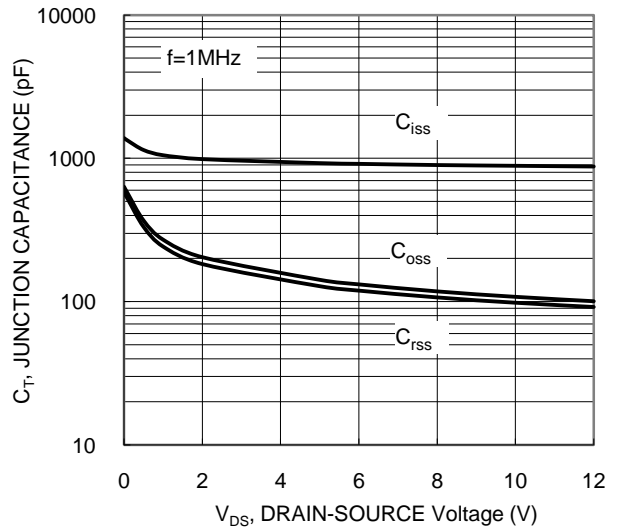

Figure 10. Typical Junction Capacitance

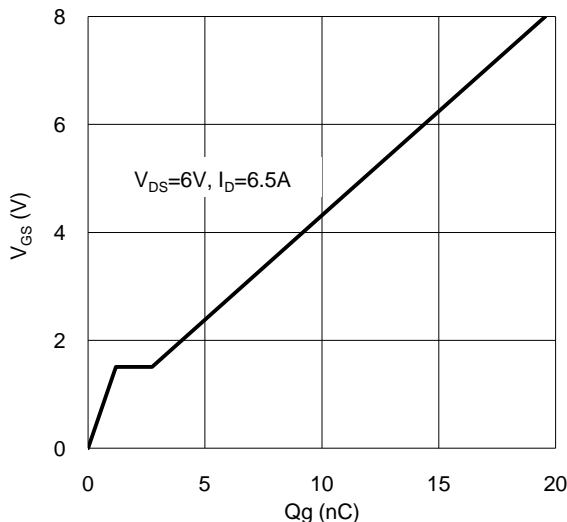

Figure 11. Gate Charge

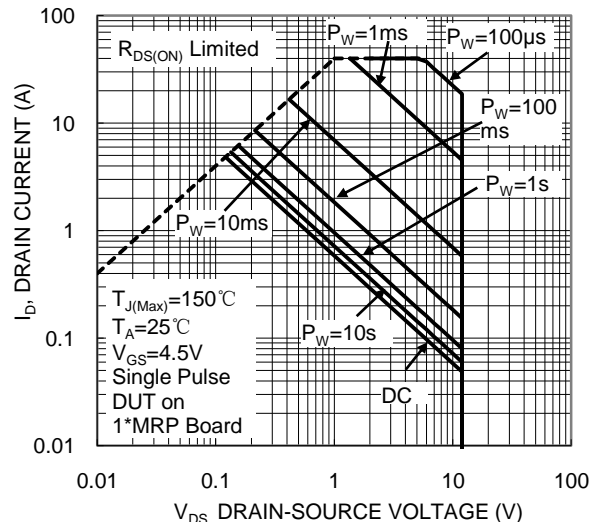

Figure 12. SOA, Safe Operation Area

Typical Characteristics - P-CHANNEL

NEW PRODUCT

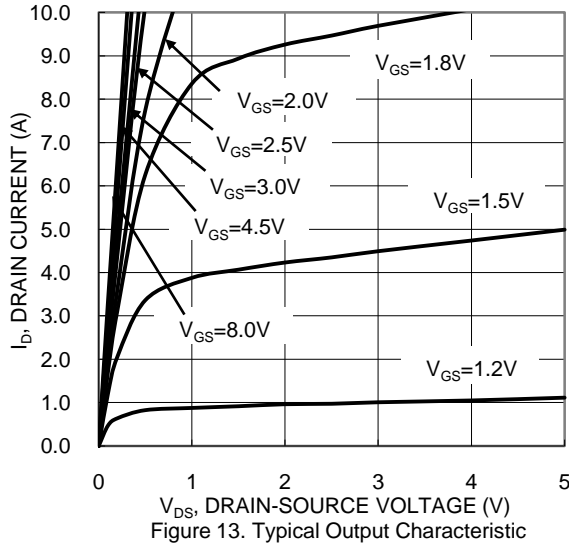

Figure 13. Typical Output Characteristic

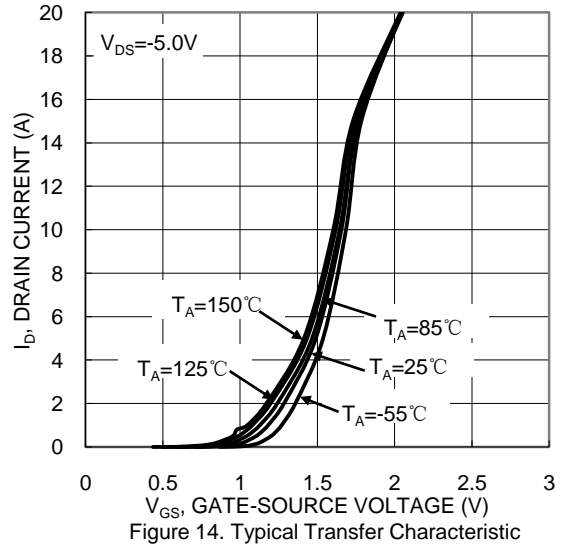

Figure 14. Typical Transfer Characteristic

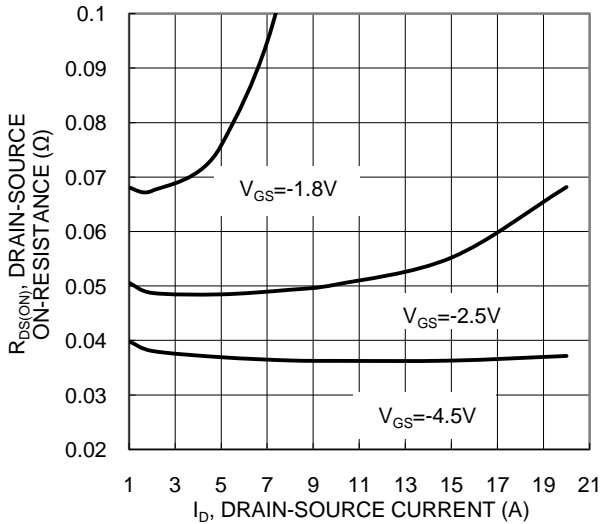

Figure 15. Typical On-Resistance vs Drain Current and Gate Voltage

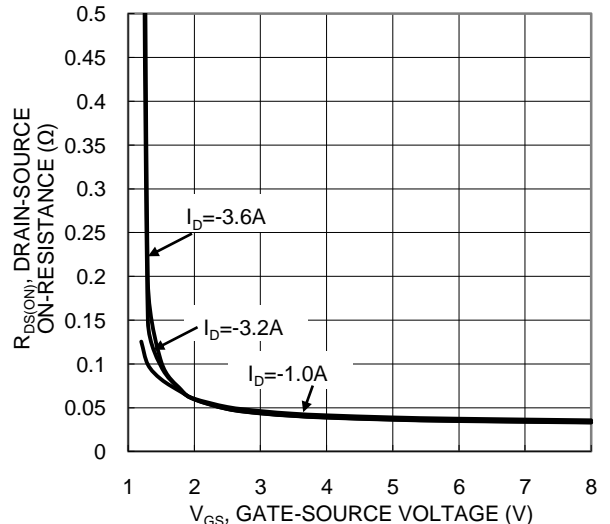

Figure 16. Typical Transfer Characteristic

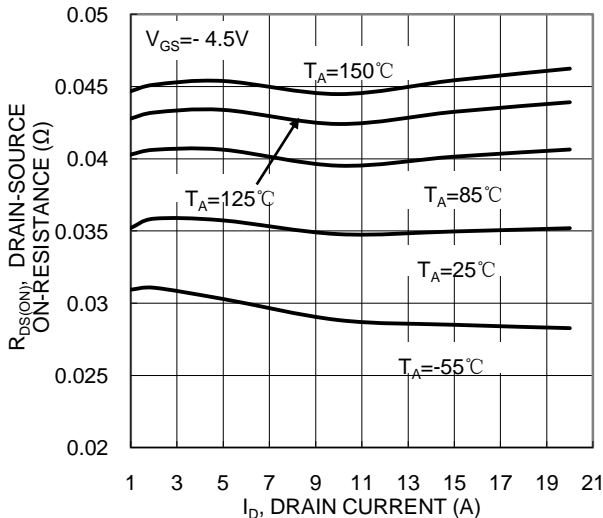

Figure 17. Typical On-Resistance vs Drain Current and Temperature

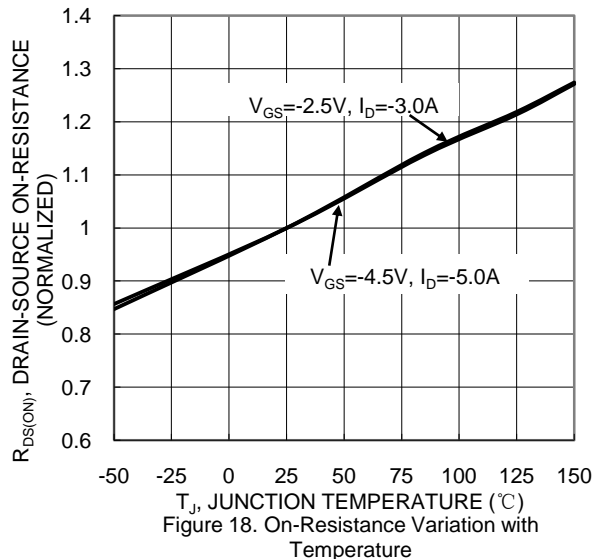

Figure 18. On-Resistance Variation with Temperature

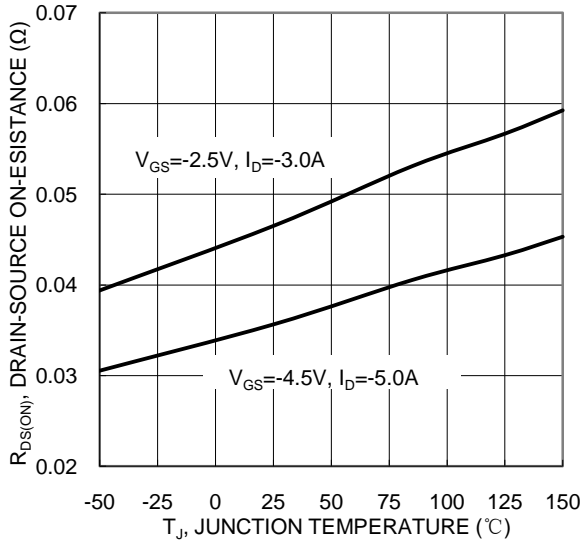

Figure 19. On-Resistance Variation with Temperature

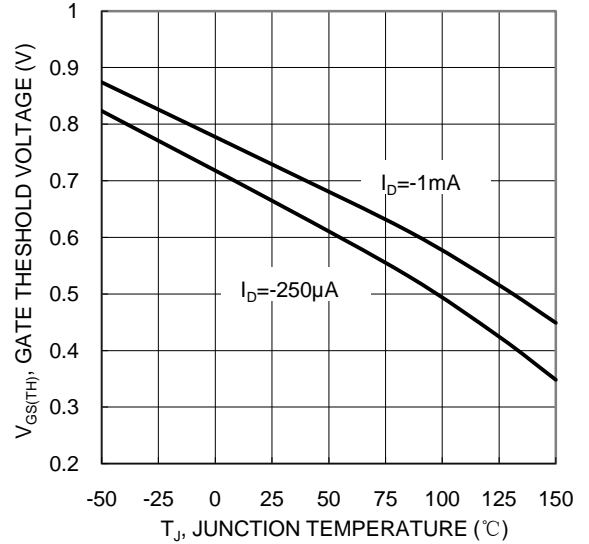

Figure 20. Gate Threshold Variation vs Junction Temperature

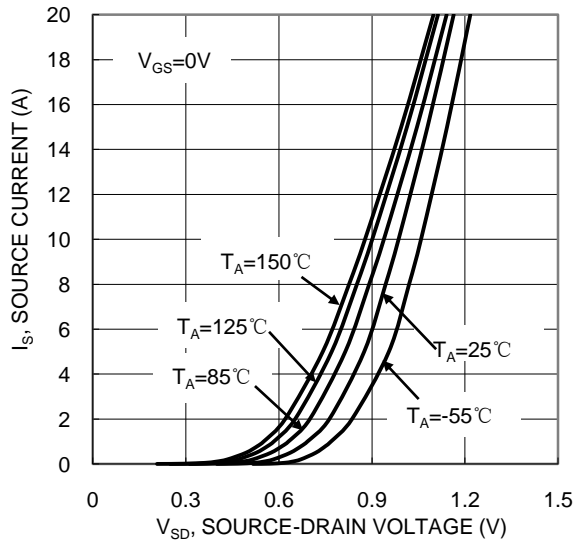

Figure 21. Diode Forward Voltage vs. Current

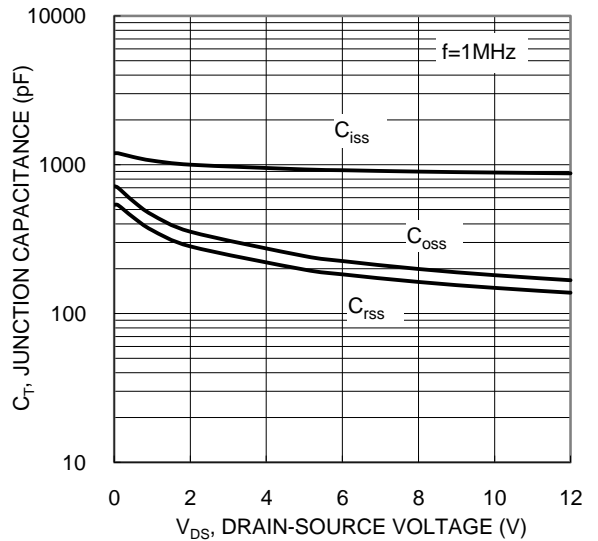

Figure 22. Typical Junction Capacitance

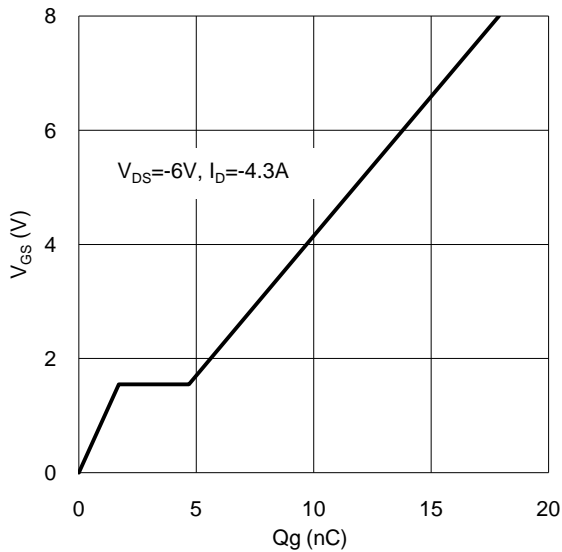

Figure 23. Gate Charge

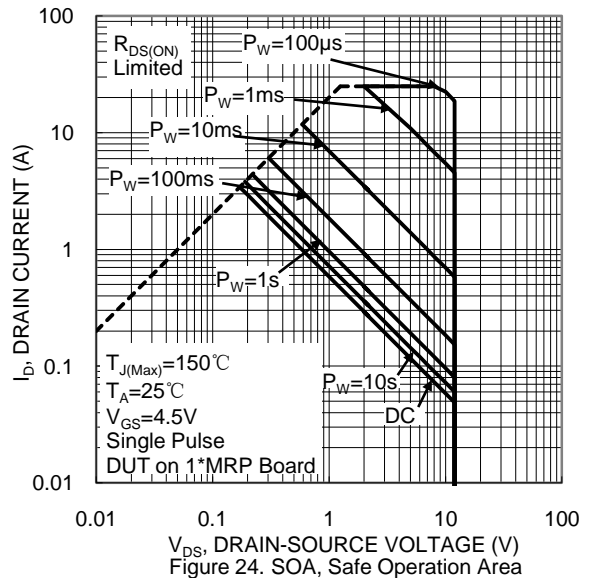

Figure 24. SOA, Safe Operation Area

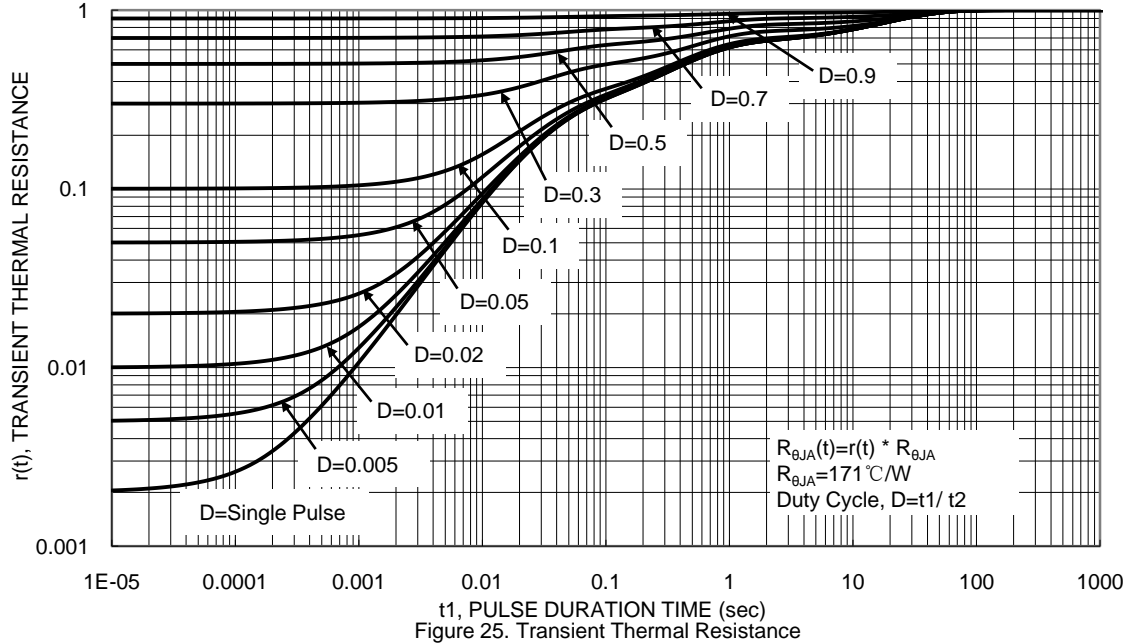
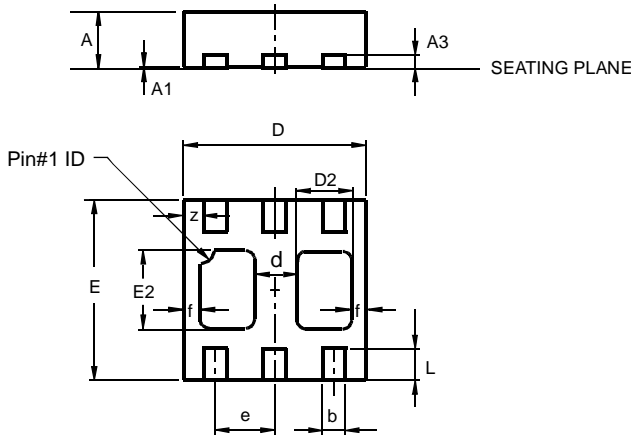

Figure 25. Transient Thermal Resistance

Package Outline Dimensions

Please see AP02002 at <http://www.diodes.com/datasheets/ap02002.pdf> for the latest version.



U-DFN2020-6 Type B			
Dim	Min	Max	Typ
A	0.545	0.605	0.575
A1	0	0.05	0.02
A3	—	—	0.13
b	0.20	0.30	0.25
D	1.95	2.075	2.00
d	—	—	0.45
D2	0.50	0.70	0.60
e	—	—	0.65
E	1.95	2.075	2.00
E2	0.90	1.10	1.00
f	—	—	0.15
L	0.25	0.35	0.30
z	—	—	0.225
All Dimensions in mm			

Suggested Pad Layout

Please see AP02001 at <http://www.diodes.com/datasheets/ap02001.pdf> for the latest version.

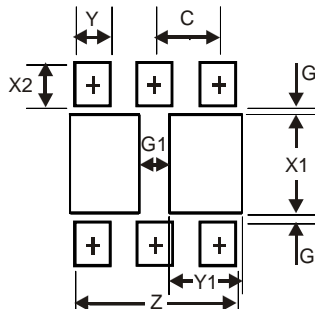

Dimensions	Value (in mm)
Z	1.67
G	0.20
G1	0.40
X1	1.0
X2	0.45
Y	0.37
Y1	0.70
C	0.65

IMPORTANT NOTICE

DIODES INCORPORATED MAKES NO WARRANTY OF ANY KIND, EXPRESS OR IMPLIED, WITH REGARDS TO THIS DOCUMENT, INCLUDING, BUT NOT LIMITED TO, THE IMPLIED WARRANTIES OF MERCHANTABILITY AND FITNESS FOR A PARTICULAR PURPOSE (AND THEIR EQUIVALENTS UNDER THE LAWS OF ANY JURISDICTION).

Diodes Incorporated and its subsidiaries reserve the right to make modifications, enhancements, improvements, corrections or other changes without further notice to this document and any product described herein. Diodes Incorporated does not assume any liability arising out of the application or use of this document or any product described herein; neither does Diodes Incorporated convey any license under its patent or trademark rights, nor the rights of others. Any Customer or user of this document or products described herein in such applications shall assume all risks of such use and will agree to hold Diodes Incorporated and all the companies whose products are represented on Diodes Incorporated website, harmless against all damages.

Diodes Incorporated does not warrant or accept any liability whatsoever in respect of any products purchased through unauthorized sales channel. Should Customers purchase or use Diodes Incorporated products for any unintended or unauthorized application, Customers shall indemnify and hold Diodes Incorporated and its representatives harmless against all claims, damages, expenses, and attorney fees arising out of, directly or indirectly, any claim of personal injury or death associated with such unintended or unauthorized application.

Products described herein may be covered by one or more United States, international or foreign patents pending. Product names and markings noted herein may also be covered by one or more United States, international or foreign trademarks.

This document is written in English but may be translated into multiple languages for reference. Only the English version of this document is the final and determinative format released by Diodes Incorporated.

LIFE SUPPORT

Diodes Incorporated products are specifically not authorized for use as critical components in life support devices or systems without the express written approval of the Chief Executive Officer of Diodes Incorporated. As used herein:

A. Life support devices or systems are devices or systems which:

1. are intended to implant into the body, or
2. support or sustain life and whose failure to perform when properly used in accordance with instructions for use provided in the labeling can be reasonably expected to result in significant injury to the user.

B. A critical component is any component in a life support device or system whose failure to perform can be reasonably expected to cause the failure of the life support device or to affect its safety or effectiveness.

Customers represent that they have all necessary expertise in the safety and regulatory ramifications of their life support devices or systems, and acknowledge and agree that they are solely responsible for all legal, regulatory and safety-related requirements concerning their products and any use of Diodes Incorporated products in such safety-critical, life support devices or systems, notwithstanding any devices- or systems-related information or support that may be provided by Diodes Incorporated. Further, Customers must fully indemnify Diodes Incorporated and its representatives against any damages arising out of the use of Diodes Incorporated products in such safety-critical, life support devices or systems.

Copyright © 2015, Diodes Incorporated

www.diodes.com