

**Vectron International****Filter specification****TFS 1632****1/5****Measurement condition**

|                          |       |          |
|--------------------------|-------|----------|
| Ambient temperature:     | 23    | °C       |
| Input power level:       | 0     | dBm      |
| Terminating impedance: * |       |          |
| Input:                   | 200 Ω | -0,48 pF |
| Output:                  | 75 Ω  |          |

**Characteristics**

## Remark:

The nominal frequency  $f_N$  is fixed at 1632,0 MHz. The insertion loss  $a_e$  is defined as loss value determined at  $f_N$ . Reference level for the relative attenuation  $a_{rel}$  of the TFS 1632 is the insertion loss  $a_e$ . All specified data are met within the operating temperature range.

| <b>D a t a</b>                              |             | <b>typ. value</b> | <b>tolerance / limit</b> |
|---|-------------|-------------------|--------------------------|
| <b>Insertion loss</b><br>(reference level)  | $a_e$       | 2,2 dB            | max. 3,0 dB              |
| <b>Nominal frequency</b>                    | $f_N$       | -                 | 1632,0 MHz               |
| <b>Passband</b>                             | PB          | -                 | $f_N \pm 20,0$ MHz       |
| <b>Pass band variation</b>                  |             | 1,1 dB            | max. 2,0 dB              |
| <b>Relative attenuation</b>                 | $a_{rel}$   |                   |                          |
| 0,3 MHz ... 860 MHz                         |             | 62 dB             | min. 55 dB               |
| 860 MHz ... 1100 MHz                        |             | 54 dB             | min. 46 dB               |
| 1100 MHz ... 1539,7 MHz                     |             | 45 dB             | min. 43 dB               |
| 1724,6 MHz ... 2000 MHz                     |             | 40 dB             | min. 33 dB               |
| 2000 MHz ... 2250 MHz                       |             | 44 dB             | min. 40 dB               |
| 2250 MHz ... 6000 MHz                       |             | 28 dB             | min. 15 dB               |
| <b>Group delay ripple</b>                   |             |                   |                          |
| 1613,6 MHz ... 1650,3 MHz                   |             | 7 ns              | max. 15 ns               |
| <b>Input VSWR within PB</b>                 |             | 2,0:1             | max. 2,4 : 1             |
| <b>Output VSWR within PB</b>                |             | 2,0:1             | max. 2,4 : 1             |
| <b>CMRR *** within PB</b>                   |             | 26 dB             | min. 20 dB               |
| <b>Input power level</b>                    |             | -                 | max. 10 dBm              |
| <b>Permissible DC voltage</b>               |             | -                 | max. 0 V                 |
| <b>Operable temperature range</b>           |             | -                 | - 30 °C ... + 80 °C      |
| <b>Operating temperature range</b>          | OTR         | -                 | - 20 °C ... + 50 °C      |
| <b>Storage temperature range</b>            |             | -                 | - 50 °C ... +125 °C      |
| <b>Temperature coefficient of frequency</b> | $TC_f^{**}$ | -46 ppm/K         | -                        |

\*) The terminating impedances depend on parasitics and q-values of matching elements and the board used, and are to be understood as reference values only. Should there be additional questions do not hesitate to ask for an application note or contact our design team.

\*\*)  $\Delta f(\text{Hz}) = TC_f(\text{ppm/K}) \times (T - T_0) \times f_{T0}(\text{MHz})$

\*\*\*) CMRR: Common Mode Rejection Ratio

**Generated:****Checked / Approved:**

**Vectron International GmbH & Co. KG**  
**Potsdamer Straße 18**  
**D 14 513 TELTOW / Germany**  
**Tel: (+49) 3328 4784-0 / Fax: (+49) 3328 4784-30**  
**E-Mail: [fft@vectron.com](mailto:fft@vectron.com)**

Vectron International GmbH & Co. KG reserves the right to make changes to the product(s) and/or information contained herein without notice. No liability is assumed as a result of their use or application. No rights under any patent accompany the sale of any such product(s) or information.

**Filter characteristic**

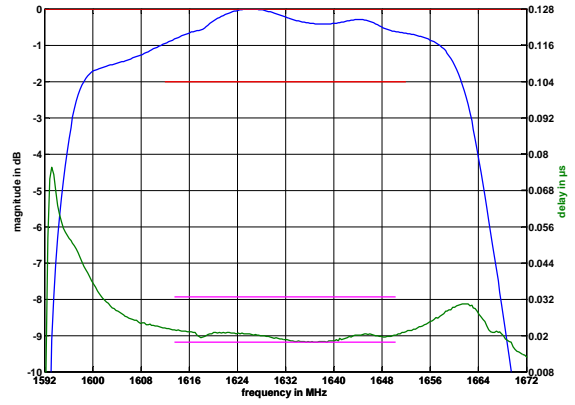
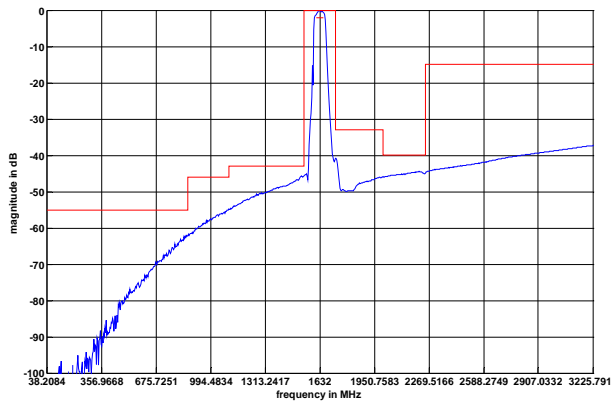

**Construction and pin connection**

(All dimensions in mm)

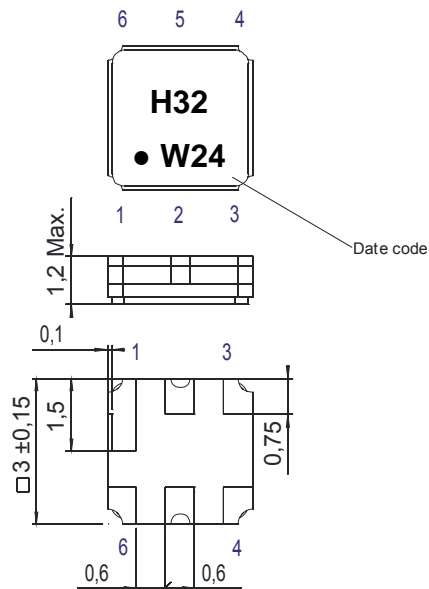

- 1 Ground
- 2 Output
- 3 Ground
- 4 Input
- 5 Ground
- 6 Input

Date code: Year + week  
 W 2008  
 X 2009  
 A 2010  
 ...

**200 Ohm / 75 Ohm Test circuit**

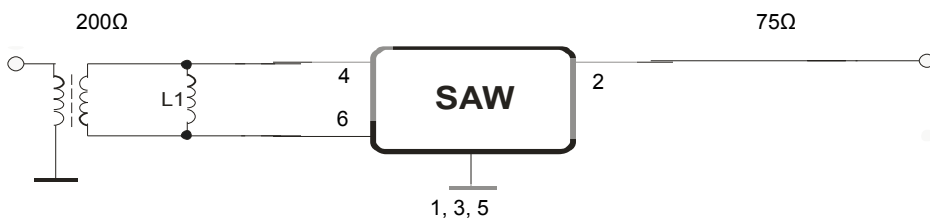

**Vectron International GmbH & Co. KG**  
 Potsdamer Straße 18  
 D 14 513 TELTOW / Germany  
 Tel: (+49) 3328 4784-0 / Fax: (+49) 3328 4784-30  
 E-Mail: [tft@vectron.com](mailto:tft@vectron.com)

Vectron International GmbH & Co. KG reserves the right to make changes to the product(s) and/or information contained herein without notice. No liability is assumed as a result of their use or application. No rights under any patent accompany the sale of any such product(s) or information.

**Stability characteristics, reliability**

After the following tests the filter shall meet the whole specification:

1. Shock: 500g, 1 ms, half sine wave, 3 shocks each plane;  
DIN IEC 68 T2 - 27
2. Vibration: 10 Hz to 500 Hz, 0,35 mm or 5 g respectively, 1 octave per min, 10 cycles per plan, 3 plans;  
DIN IEC 68 T2 - 6
3. Change of temperature: -55 °C to 125°C / 30 min. each / 10 cycles  
DIN IEC 68 part 2 – 14 Test N
4. Resistance to solder heat (reflow): reflow possible: three times max.;  
for temperature conditions refer to the attached "Air reflow temperature conditions" on page 4;

This filter is RoHS compliant (2002/95/EG, 2005/618/EG)

**Packing**

Tape & Reel: IEC 286 – 3, with exception of value for N and minimum bending radius;  
tape type II, embossed carrier tape with top cover tape on the upper side;

max. pieces of filters per reel: 9000  
reel of empty components at start: min. 300 mm  
reel of empty components at start including leader: min. 500 mm  
trailer: min. 300 mm

**Tape (all dimensions in mm)**

- W : 8,00 ± 0,3
- Po : 4,00 ± 0,1
- Do : 1,50 +0,1/-0
- E : 1,75 ± 0,1
- F : 3,50 ± 0,05
- G(min) : 0,75
- P2 : 2,00 ± 0,05
- P1 : 4,00 ± 0,1
- D1(min) : 1,50
- Ao : 3,25 ± 0,1
- Bo : 3,25 ± 0,1
- Ct : 5,5 ± 0,1

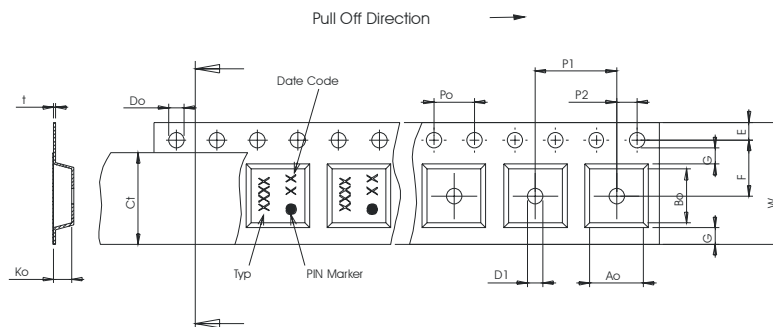

**Reel (all dimensions in mm)**

- A : 330
- W1 : 8,4 +1,5/-0
- W2(max) : 14,4
- N(min) : 50
- C : 13,0 +0,5/-0,2

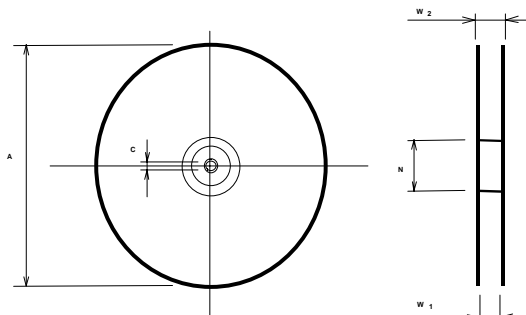

The minimum bending radius is 45 mm.

**Vectron International GmbH & Co. KG**  
**Potsdamer Straße 18**  
**D 14 513 TELTOW / Germany**  
**Tel: (+49) 3328 4784-0 / Fax: (+49) 3328 4784-30**  
**E-Mail: [tft@vectron.com](mailto:tft@vectron.com)**

Vectron International GmbH & Co. KG reserves the right to make changes to the product(s) and/or information contained herein without notice. No liability is assumed as a result of their use or application. No rights under any patent accompany the sale of any such product(s) or information.

**Air reflow temperature conditions**

| <b>Conditions</b>                          | <b>Exposure</b>             |
|--|-----------------------------|
| Average ramp-up rate (30°C to 217°C)       | less than 3°C/second        |
| > 100°C                                    | between 300 and 600 seconds |
| > 150°C                                    | between 240 and 500 seconds |
| > 217°C                                    | between 30 and 150 seconds  |
| Peak temperature                           | max. 260°C                  |
| Time within 5°C of actual peak temperature | between 10 and 30 seconds   |
| Cool-down rate (Peak to 50°C)              | less than 6°C/second        |
| Time from 30°C to Peak temperature         | no greater than 300 seconds |

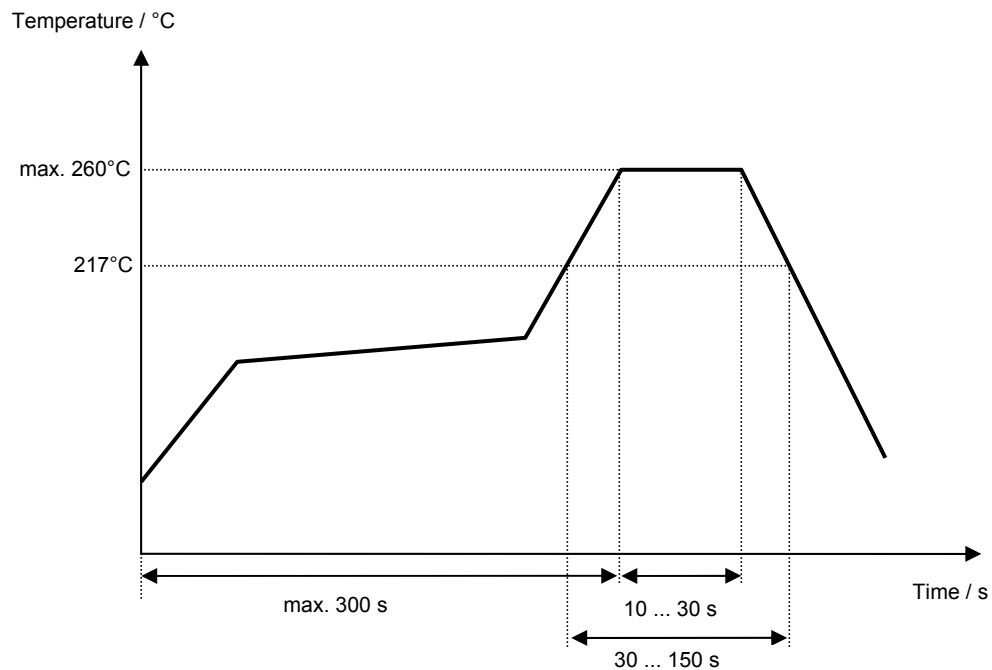
**Chip-mount air reflow profile**

**Vectron International GmbH & Co. KG**  
 Potsdamer Straße 18  
 D 14 513 TELTOW / Germany  
 Tel: (+49) 3328 4784-0 / Fax: (+49) 3328 4784-30  
 E-Mail: [tft@vectron.com](mailto:tft@vectron.com)

Vectron International GmbH & Co. KG reserves the right to make changes to the product(s) and/or information contained herein without notice. No liability is assumed as a result of their use or application. No rights under any patent accompany the sale of any such product(s) or information.

**History**

| <b>Version</b> | <b>Reason of Changes</b>   | <b>Name</b> | <b>Date</b> |
|----------------|--|-------------|-------------|
| 1.0            | - Generation of development specification  | Strehl      | 19.06.2007  |
| 1.1            | - Change and add data  | Strehl      | 18.07.2007  |
| 1.2            | - Change passband, passband variation<br>- Change attenuation and OTR  | S. Channaa  | 08.02.2008  |
| 1.3            | - Change attenuation, group delay ripple and vswr<br>- Add typical values, filter characteristic, generation of filter specification | S. Channaa  | 06.05.2008  |
| 1.4            | - Correct construction   | Strehl      | 09.06.2008  |