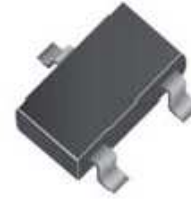

## Small Signal Product

**225mW SMD Switching Diode**
**FEATURES**

- Fast switching speed
- Surface mount device type
- Moisture sensitivity level 1
- Matte Tin(Sn) lead finish with Nickel(Ni) underplate
- Pb free and RoHS compliant
- Green compound (Halogen free) with suffix "G" on packing code and prefix "G" on date code

**MECHANICAL DATA**

- Case: SOT-23 small outline plastic package
- Terminal: Matte tin plated, lead free, solderable per MIL-STD-202, Method 208 guaranteed
- High temperature soldering guaranteed: 260°C/10s
- Weight: 0.008grams (approximately)

**SOT-23**

<b>MAXIMUM RATINGS AND ELECTRICAL CHARACTERISTICS</b> ( $T_A=25^\circ\text{C}$ unless otherwise noted)			
PARAMETER	SYMBOL	VALUE	UNIT
Power dissipation	$P_D$	225	mW
Peak repetitive reverse voltage	$V_{RRM}$	70	V
Repetitive peak forward current	$I_{FRM}$	450	mA
Mean forward current	$I_O$	200	mA
Non-repetitive peak forward surge current	$I_{FSM}$	Pulse Width=1 sec	0.5
		Pulse Width=1 $\mu\text{sec}$	2
Thermal resistance form junction to ambient	$R_{\theta JA}$	556	$^\circ\text{C/W}$
Junction and storage temperature range	$T_J, T_{STG}$	- 55 to + 150	$^\circ\text{C}$

PARAMETER	SYMBOL	MIN	MAX	UNIT
Reverse breakdown voltage	$V_{(BR)}$	70	-	V
Forward voltage	$V_F$	$I_F = 50 \text{ mA}$	1.00	V
		$I_F = 150 \text{ mA}$	1.25	
Reverse leakage current	$I_R$	-	2.50	$\mu\text{A}$
Junction capacitance	$C_J$	$V_R = 0 \text{ V}, f = 1 \text{ MHz}$	BAW56, BAV70	2
			BAV99	1.5
Reverse recovery time	$t_{rr}$	-	6	ns

Small Signal Product

**RATINGS AND CHARACTERISTICS CURVES**

(TA=25°C unless otherwise noted)

Fig. 1 Typical Forward Characteristics

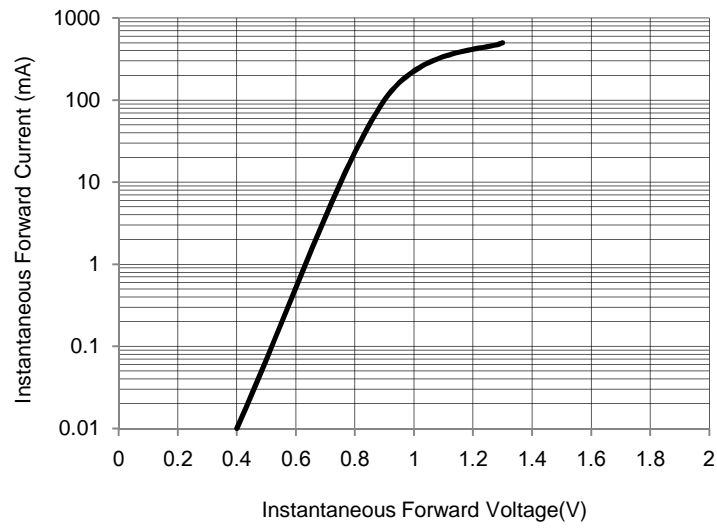

Fig. 2 Leakage Current VS. Junction Temperature

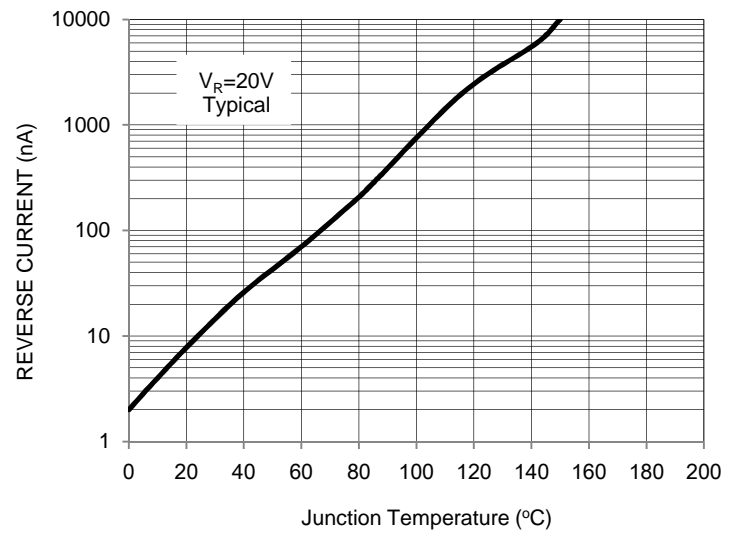
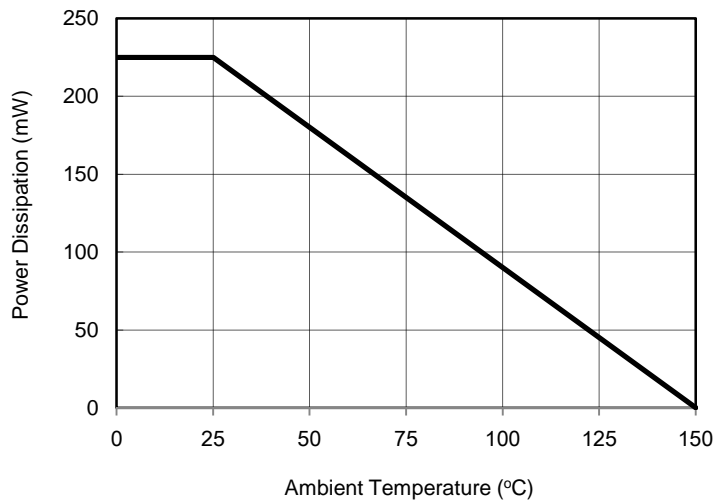

Fig. 3 Power Dissipation Derating Curve



Small Signal Product

<b>ORDERING INFORMATION</b>						
<b>PART NO.</b>	<b>MANUFACTURE CODE</b>	<b>PACKING CODE</b>	<b>GREEN COMPOUND CODE</b>	<b>PACKAGE</b>	<b>PACKING</b>	<b>MARKING</b>
BAW56	(Note)	RF		SOT-23	3K / 7" Reel	A1
BAV70		RF		SOT-23	3K / 7" Reel	A4
BAV99		RF		SOT-23	3K / 7" Reel	A7
BAW56		RF	G	SOT-23	3K / 7" Reel	A1
BAV70		RF	G	SOT-23	3K / 7" Reel	A4
BAV99		RF	G	SOT-23	3K / 7" Reel	A7

Note: Manufacture special control, if empty means no special control requirement.

<b>EXAMPLE</b>					
<b>PREFERRED P/N</b>	<b>PART NO.</b>	<b>MANUFACTURE CODE</b>	<b>PACKING CODE</b>	<b>GREEN COMPOUND CODE</b>	<b>DESCRIPTION</b>
BAV99 RF	BAV99		RF		
BAV99-B0 RF	BAV99	B0	RF		
BAV99-D0 RF	BAV99	D0	RF		
BAV99 RFG	BAV99		RF	G	Green compound
BAV99-B0 RFG	BAV99	B0	RF	G	Green compound
BAV99-D0 RFG	BAV99	D0	RF	G	Green compound

Small Signal Product

**PACKAGE OUTLINE DIMENSIONS**

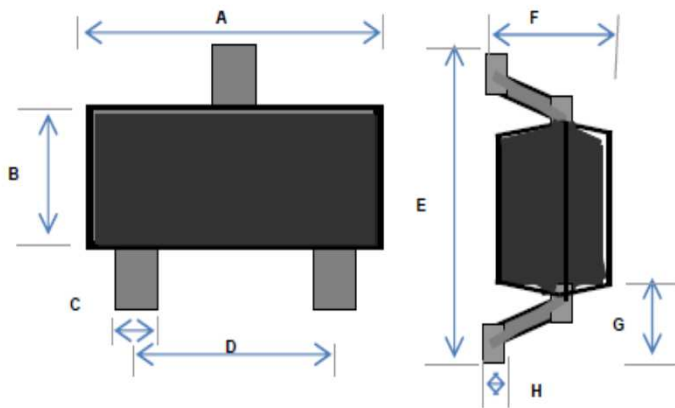

DIM.	Unit (mm)		Unit (inch)	
	Min	Max	Min	Max
A	2.70	3.10	0.106	0.122
B	1.10	1.50	0.043	0.059
C	0.30	0.51	0.012	0.020
D	1.78	2.04	0.070	0.080
E	2.10	2.64	0.083	0.104
F	0.89	1.30	0.035	0.051
G	0.55 REF		0.022 REF	
H	0.1 REF		0.004 REF	

**SUGGEST PAD LAYOUT**

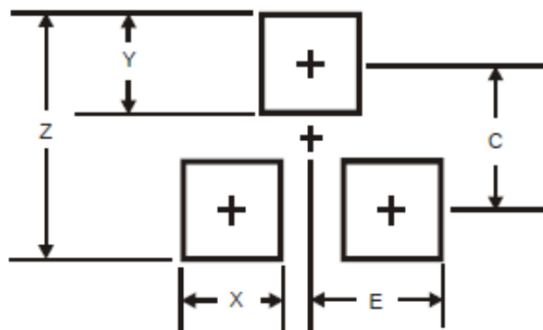

DIM.	Unit (mm)	Unit (inch)
	Typ.	Typ.
Z	2.9	0.114
X	0.8	0.031
Y	0.9	0.035
C	2.0	0.079
E	1.35	0.053

**Pin Configuration**

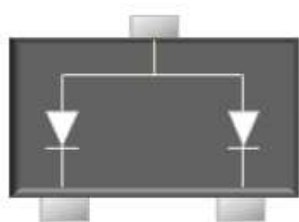

**BAW56**

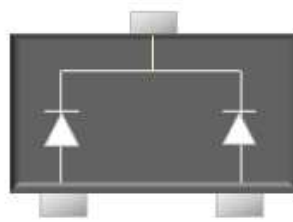

**BAV70**

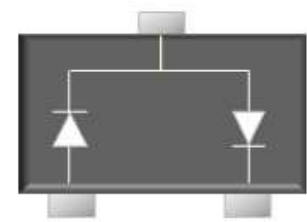

**BAV99**