

AH420

4W High Linearity InGaP HBT Amplifier



Product Features

- 400 – 2700 MHz
- +35.7 dBm P1dB
- -49 dBc ACLR @ 26 dBm
- 14 dB Gain @ 2140 MHz
- 800 mA Quiescent Current
- +5 V Single Supply
- MTTF > 100 Years
- Lead-free/green/RoHS-compliant 12-pin 4x5mm DFN Package

Applications

- Final stage amplifiers for Repeaters
- High Power Amplifiers
- Mobile Infrastructure
- LTE / WCDMA / EDGE / CDMA

Product Description

The AH420 is a high dynamic range amplifier in a low-cost surface mount package. The InGaP/GaAs HBT is able to achieve high performance with -49 dBc ACLR and +35.7 dBm of compressed 1dB power, operating off of a single +5V supply. It is housed in a lead-free/green/RoHS-compliant 4x5mm DFN package. All devices are 100% RF and DC tested.

The AH420 is targeted for use as a final stage amplifier in wireless infrastructure repeaters or as driver stages for high power amplifiers where high performance is required. In addition, the amplifier can be used for a wide variety of other applications within the 400 to 2700 MHz frequency band. By operating off of a single +5V rail, other higher voltage rails are not necessarily needed thus saving system costs. The amplifier also has the flexibility to operate at higher voltage levels to achieve higher compression if needed by the system.

Functional Diagram

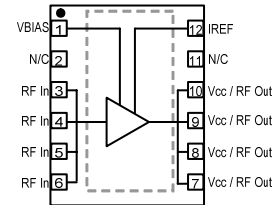

Function	Pin No.
RF _{IN}	3,4,5,6
RF _{OUT}	7,8,9,10
I _{REF}	12
V _{BIAS}	1
NC	2,11

Specifications

Parameter	Units	Min	Typ	Max
Operational Bandwidth	MHz	400		2700
Test Frequency	MHz		2140	
Output Channel Power	dBm		+26	
Gain	dB	13	14	16
Input Return Loss	dB		12	
Output Return Loss	dB		7.4	
ACLR ⁽²⁾	dBc		-49	
Output P1dB	dBm		+35.7	
Output IP3 ⁽⁴⁾	dBm	+46.5	+50	
Quiescent Collector Current ⁽³⁾	mA	710	800	900
I _{ref}	mA		20	
V _{cc} , V _{bias}	V		+5	

1. Test conditions unless otherwise noted: 25°C, +5V Vsupply, 2140 MHz, in tuned application circuit.
2. W-CDMA 3GPP Test Model 1+64 DPCH, PAR = 10.2 dB @ 0.01% Probability, 3.84 MHz BW
3. This corresponds to the quiescent current under small-signal conditions into pins 6, 7, and 8 when the current setting resistor, R4 connected to the I_{ref} pin, is at 82 Ω.
4. OIP3 is measured with two tones at out an output power of +27 dBm/tone separated by 1 MHz. The suppression on the largest IM3 product is used to calculate the 3OIP using a 2:1 rule.

Typical Performance

Parameter	Units	Typical		
Frequency	MHz	940	1960	2140
Channel Power	dBm	+27	+27	+26
Gain	dB	16	14.1	14
Input Return Loss	dB	14	19	12
Output Return Loss	dB	6.4	7	7.4
ACLR ⁽²⁾	dBc	-46.5	-48	-49
Output P1dB	dBm	+35.2	+35.6	+35.7
Noise Figure	dB	6.6	5.3	5.6
Output IP3 ⁽⁴⁾	dBm	+50	+49	+50
Quiescent Collector Current ⁽³⁾	mA	800		
I _{ref}	mA	20		
V _{cc} , V _{bias}	V	+5		

5. The amplifier has been tested for ruggedness to be capable of handling:
 10:1 VSWR @ 5V_{cc}, 2140MHz, +35.2dBm CW Pout, 25 °C
 10:1 VSWR @ 5V_{cc}, 940MHz, +28.5dBm IS-95A Pout, 25 °C
 10:1 VSWR @ 5V_{cc}, 2140MHz, +26.5dBm WCDMA Pout, 25 °C

Absolute Maximum Ratings

Parameter	Rating
Storage Temperature	-65 to +150 °C
V _{cc} , V _{bias}	+14 V
RF Input Power, CW, 50 Ω, T=25°C	Input P9dB
Reference Current, I _{ref}	170 mA
Dissipated Power, P _{max}	7 W
Max Junction Temperature, T _J For 10 ⁶ hours MTTF	158 °C
Thermal Resistance, Θ _{JC}	10.6 °C / W

Operation of this device above any of these parameters may cause permanent damage.

Ordering Information

Part No.	Description
AH420-EG	4W High Linearity InGaP HBT Amplifier
AH420-EPCB900	920-960 MHz Evaluation Board
AH420-EPCB1960	1930-1990 MHz Evaluation Board
AH420-EPCB2140	2110-2170 MHz Evaluation Board

Standard T/R size = 1000 pieces on a 7" reel.

Specifications and information are subject to change without notice.

AH420

4W High Linearity InGaP HBT Amplifier



Application Circuit PC Board Layout

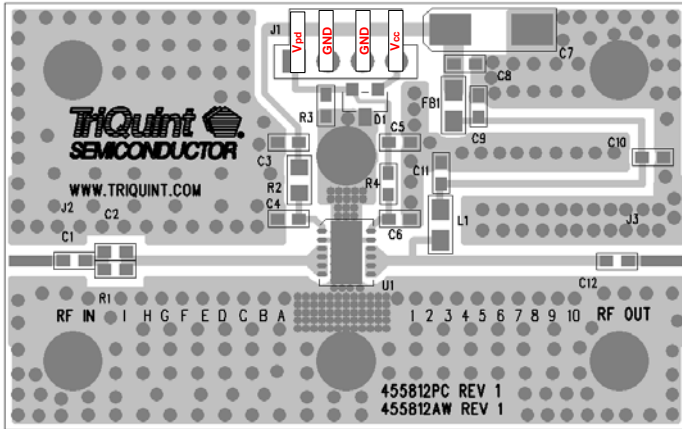

Circuit Board Material: 0.014" GETEK, single layer, 1 oz copper, $\epsilon_r = 4.2$,
Microstrip line details: width = .030", marker spacing = .050"

Baseplate Configuration

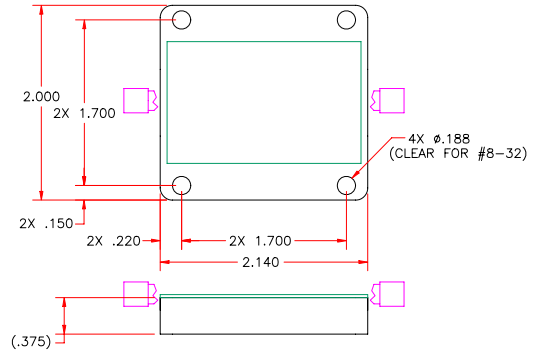

Notes:

1. Please note that for reliable operation, the evaluation board will have to be mounted to a much larger heat sink during operation and in laboratory environments to dissipate the power consumed by the device. The use of a convection fan is also recommended in laboratory environments.
2. The area around the module underneath the PCB should not contain any soldermask in order to maintain good RF grounding.

Typical Device Data

S-Parameters ($V_{CC} = +5\text{ V}$, $I_{CC} = 800\text{ mA}$, $25\text{ }^\circ\text{C}$, unmatched 50 ohm system)

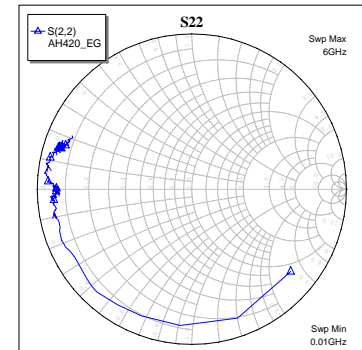
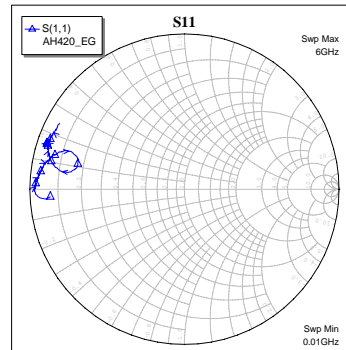
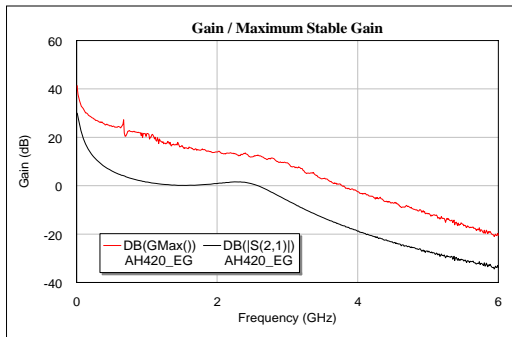

Notes:

The gain for the unmatched device in 50 ohm system is shown as the trace in black color. For a tuned circuit for a particular frequency, it is expected that actual gain will be higher, up to the maximum stable gain. The maximum stable gain is shown in the red line.

S-Parameters ($V_{CC} = +5\text{ V}$, $I_{CC} = 800\text{ mA}$, $25\text{ }^\circ\text{C}$, unmatched 50 ohm system, calibrated to device leads)

Freq (MHz)	S11 (dB)	S11 (deg)	S21 (dB)	S21 (deg)	S12 (dB)	S12 (deg)	S22 (dB)	S22 (deg)
10	-1.22	-176.79	29.97	155.67	-52.77	64.11	-1.61	-39.70
50	-0.44	-177.23	24.42	117.15	-45.04	32.25	-1.05	-122.90
100	-0.31	-178.77	19.17	103.73	-44.01	11.29	-1.16	-150.31
300	-0.28	179.40	10.27	90.61	-43.22	5.32	-0.94	-169.59
500	-0.30	178.17	6.16	84.91	-43.10	-0.42	-0.93	-174.28
700	-0.40	176.72	3.74	79.16	-43.48	36.07	-1.02	-177.33
900	-0.43	175.77	2.09	74.69	-41.72	5.11	-1.07	-177.23
1100	-0.50	173.96	0.99	69.01	-41.21	-1.08	-1.11	-178.10
1300	-0.59	171.86	0.42	62.55	-40.35	-4.63	-1.15	-178.55
1500	-0.74	169.75	0.16	55.48	-39.33	-10.41	-1.21	-179.14
1700	-0.98	167.20	0.25	46.05	-38.86	-20.47	-1.24	-179.88
1900	-1.40	164.19	0.63	34.50	-38.13	-34.84	-1.24	179.85
2100	-2.04	161.94	1.22	18.13	-36.71	-51.74	-1.19	179.15
2300	-2.78	163.47	1.53	-4.61	-35.70	-78.76	-0.95	178.06
2500	-2.88	169.61	0.74	-32.66	-36.03	-114.19	-0.62	175.59
2700	-2.04	171.93	-1.59	-58.88	-37.72	-145.67	-0.52	171.28
2900	-1.32	169.73	-4.55	-77.51	-39.74	-179.01	-0.55	168.08
3100	-0.95	167.05	-7.58	-90.68	-41.31	163.85	-0.68	165.55
3300	-0.78	164.66	-10.52	-100.04	-42.50	141.73	-0.80	164.25
3500	-0.69	162.98	-13.08	-106.66	-43.74	129.82	-0.87	162.92
3700	-0.63	161.89	-15.60	-112.19	-42.73	112.53	-0.90	162.24
3900	-0.61	161.39	-17.79	-116.53	-43.74	105.15	-0.92	161.57
4100	-0.58	161.33	-19.66	-121.50	-43.35	107.61	-0.92	161.67
4300	-0.54	161.51	-21.87	-124.38	-42.62	97.03	-0.97	162.11

Device S-parameters are available for download off of the website at: <http://www.tqs.com>

920-960 MHz Reference Design (AH420-EPCB900)

W-CDMA 3GPP Test Model 1+64 DPCH, PAR = 10.2 dB @ 0.01% Probability, 3.84 MHz BW

Typical W-CDMA Performance at 25°C

Frequency (MHz)	920	940	960	Units
Channel Power	+27	+27	+27	dBm
Power Gain	15.9	16	16.1	dB
Input Return Loss	17	14	11	dB
Output Return Loss	5.3	6.4	8.0	dB
ACLR	-47	-46.5	-46.5	dBc
P1dB	+35.2	+35.2	+35.2	dBm
Output IP3 At 27dBm/tone, 1MHz spacing	+51	+50	+49	dBm
Noise Figure	6.5	6.6	6.7	dB
Quiescent Current, Icq	800			mA
Vpd, Vcc	+5			V

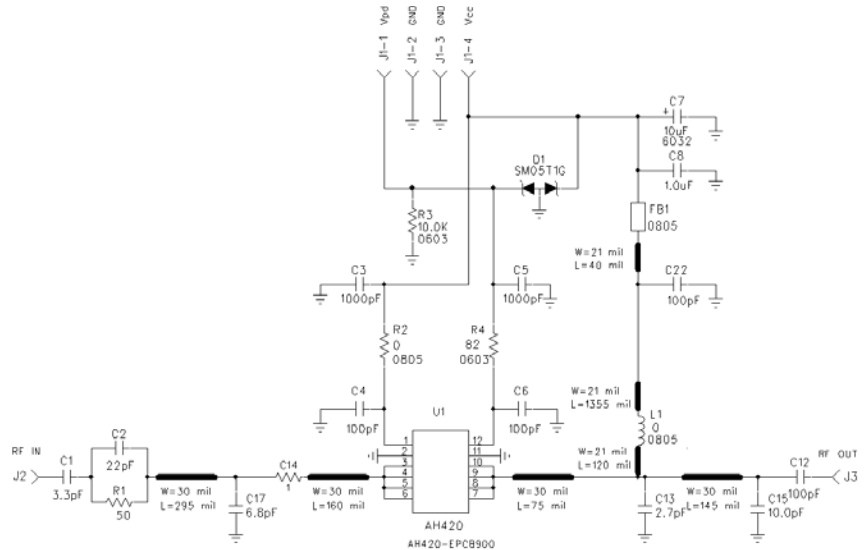
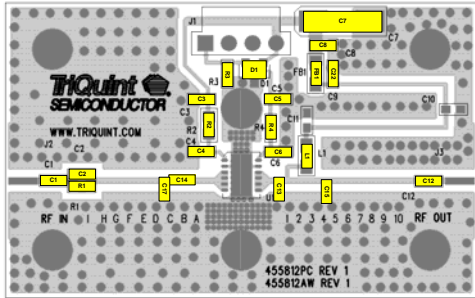

Notes:

1. The primary RF microstrip line is 50 Ω.
2. Do not exceed 5.5V on Vpd and Vcc or damage will occur to D1.
3. Components shown on the silkscreen but not on the schematic are not used.
4. Vpd used for device power down (low=RF off)
5. The edge of C13 is placed at 75mil from AH420 RFout pin. (3.9° @ 940 MHz)
6. The edge of C15 is placed 145mil from the edge of C13. (7.5° @ 940 MHz)
7. The edge of C14 is placed at 150mil from AH420 Rfin pin. (7.7° @ 940 MHz)
8. The edge of C17 is placed against the edge of C14.
9. 0 Ω jumpers can be replaced with copper trace in target application.

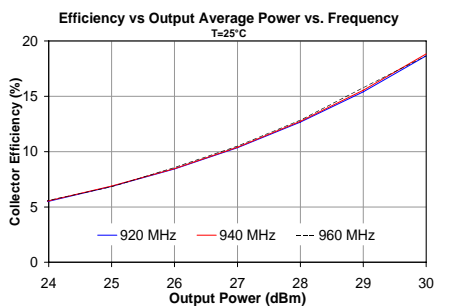
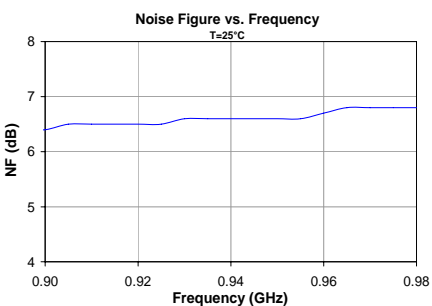
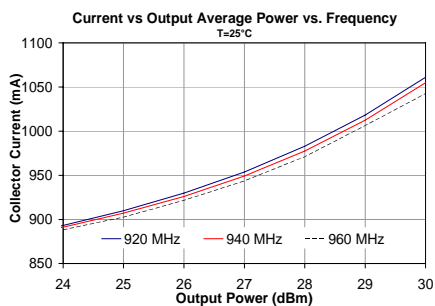
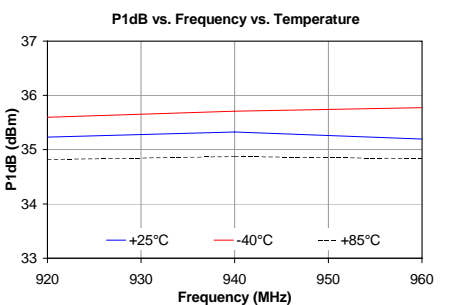
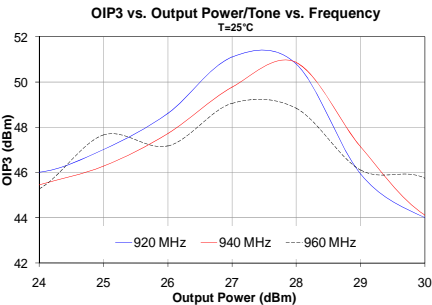
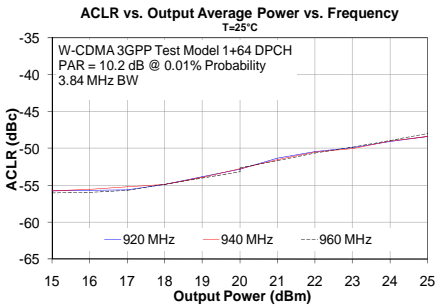
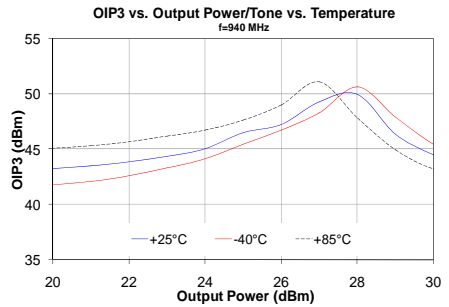
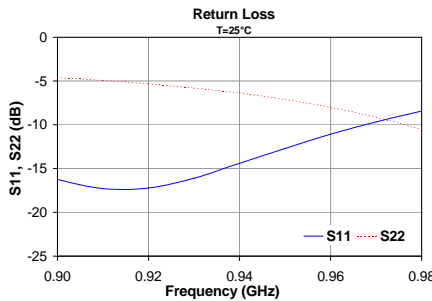
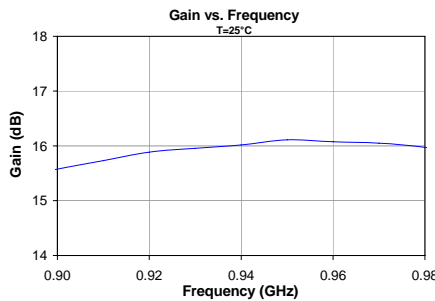

Specifications and information are subject to change without notice

1930-1990 MHz Reference Design (AH420-EPCB1960)

W-CDMA 3GPP Test Model 1+64 DPCH, PAR = 10.2 dB @ 0.01% Probability, 3.84 MHz BW

Typical W-CDMA Performance at 25°C

Frequency (MHz)	1930	1960	1990	Units
Channel Power	+27	+27	+27	dBm
Power Gain	13.4	14.1	14.1	dB
Input Return Loss	13	19	11	dB
Output Return Loss	4.7	7	12	dB
ACLR	-49	-48	-47	dBc
P1dB	+35.6	+35.6	+35.6	dBm
Output IP3 At 27dBm/tone, 1MHz spacing	+49	+49	+49	dBm
Noise Figure	5.6	5.3	5.3	dB
Quiescent Current, Icq	800			mA
Vpd, Vcc	+5			V

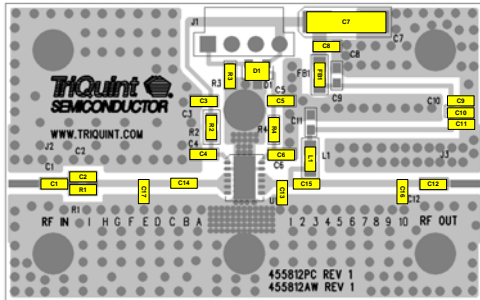
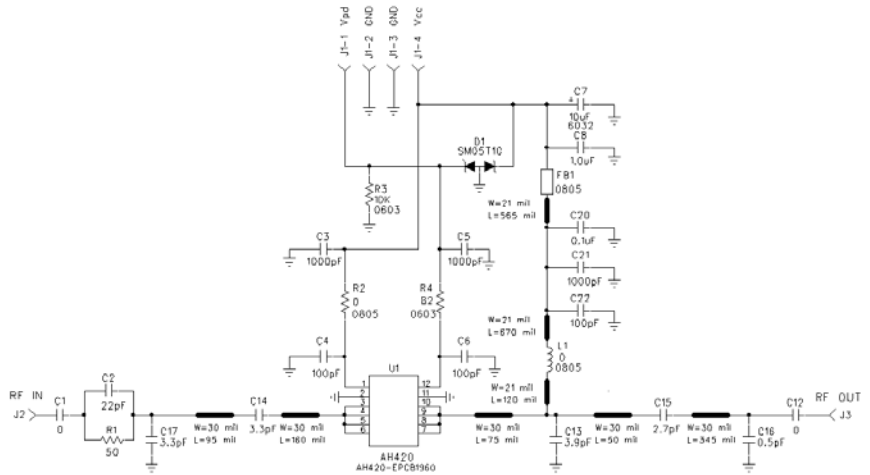

Notes:

1. The primary RF microstrip line is 50 Ω .
2. Do not exceed 5.5V on Vpd and Vcc or damage will occur to D1.
3. Components shown on the silkscreen but not on the schematic are not used.
4. Vpd used for device power down (low=RF off)
5. The edge of C13 is placed at 75mil from AH420 RFout pin. (8.0° @ 1960 MHz)
6. The edge of C15 is placed 50mil from the edge of C13. (5.3° @ 1960 MHz)
7. The edge of C16 is placed 345mil from the edge of C15. (37° @ 1960 MHz)
8. The edge of C14 is placed at 160mil from AH420 Rfin pin. (17.2° @ 1960 MHz)
9. The edge of C17 is placed 95mil from the edge of C14. (10.2° @ 1960 MHz)
10. 0 Ω jumpers can be replaced with copper trace in target application.

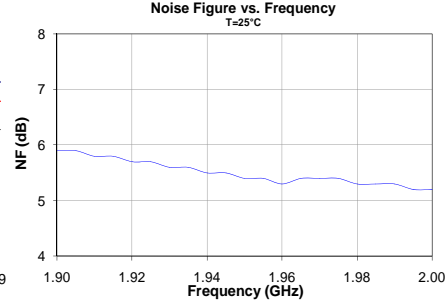
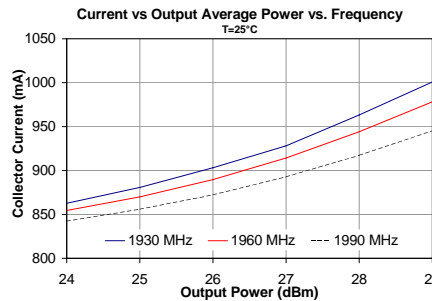
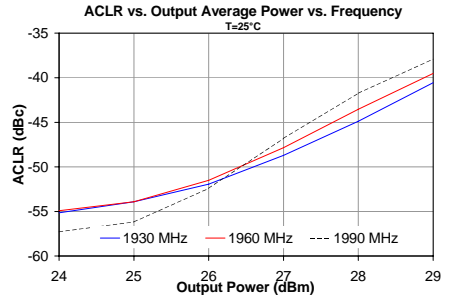
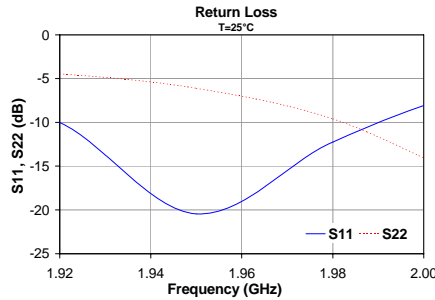
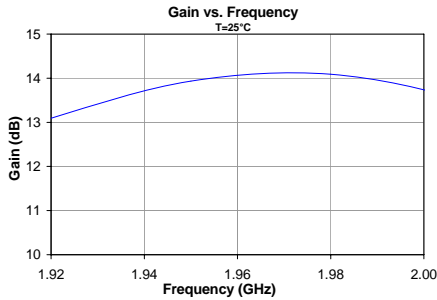

2010-2025 MHz Application Circuit Performance Plots

TD-SCDMA 3 Carrier, PAR = 10 dB @ 0.01% Probability, 1.28 MHz BW

Typical TD-SCDMA Performance at 25°C

Frequency (MHz)	2010	2015	2025	Units
Channel Power	24	24	24	dBm
Power Gain	13.6	13.6	13.7	dB
Input Return Loss	22	21	20	dB
Output Return Loss	4.8	5	5.1	dB
ACLR	-50	-50	-50	dBc
P1dB	+34	+34	+34	dBm
Output IP3 At +25 dBm/tone, 1MHz spacing	+56	+56	+55	dBm
Noise Figure	5.5	5.5	5.5	dB
Quiescent Current, Icq	800			mA
Vpd	+5			V
Vcc	+5			V

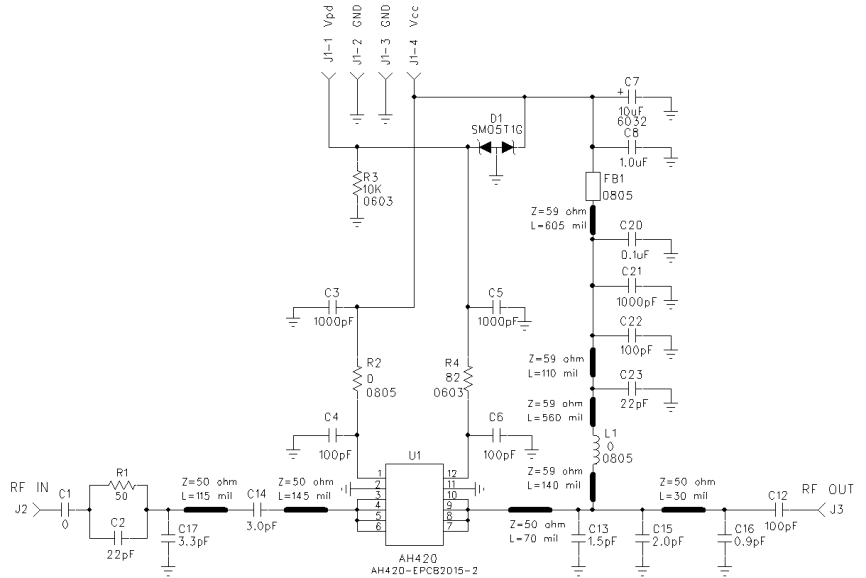
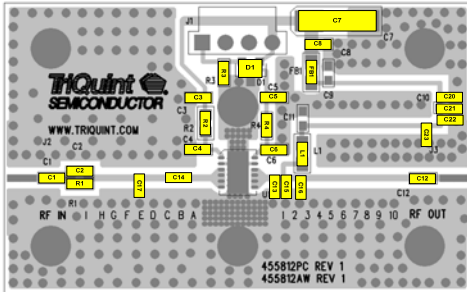

Notes:

1. The primary RF microstrip line is 50 Ω.
2. Components shown on the silkscreen but not on the schematic are not used.
3. The edge of C13 is placed at 70 mil from AH420 RFout pin. (7.7° @ 2015 MHz)
4. The edge of C15 is placed next to the edge of C13.
5. The edge of C16 is placed 30 mil from the edge of C15. (3.3° @ 2015 MHz)
6. The edge of C14 is placed at 145 mil from AH420 RFin pin. (16° @ 2015 MHz)
7. The edge of C17 is placed 115 mil from the edge of C14.

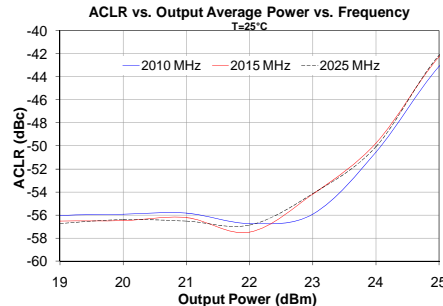
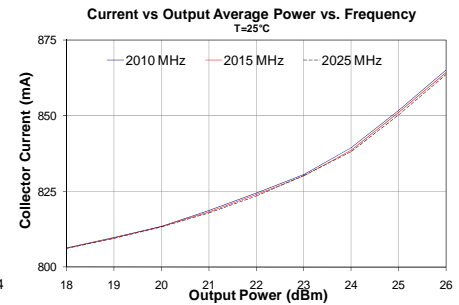
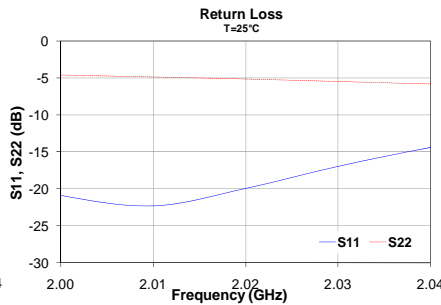
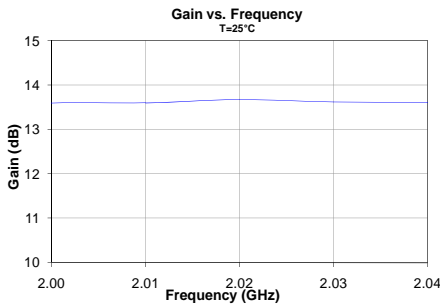

2110-2170 MHz Reference Design (AH420-EPCB2140)

W-CDMA 3GPP Test Model 1+64 DPCH, PAR = 10.2 dB @ 0.01% Probability, 3.84 MHz BW

Typical W-CDMA Performance at 25°C

Frequency (GHz)	2110	2140	2170	Units
Channel Power	+26	+26	+26	dBm
Power Gain	13.3	14	14	dB
Input Return Loss	14	12	10	dB
Output Return Loss	5	7.4	9	dB
ACLR	-50	-49	-50	dBc
P1dB	+35.8	+35.7	+35.2	dBm
Output IP3 At 27dBm/tone, 1MHz spacing	+49	+50	+50	dBm
Noise Figure	5.8	5.6	5.5	dB
Quiescent Current, Icq	800			mA
Vpd, Vcc	+5			V

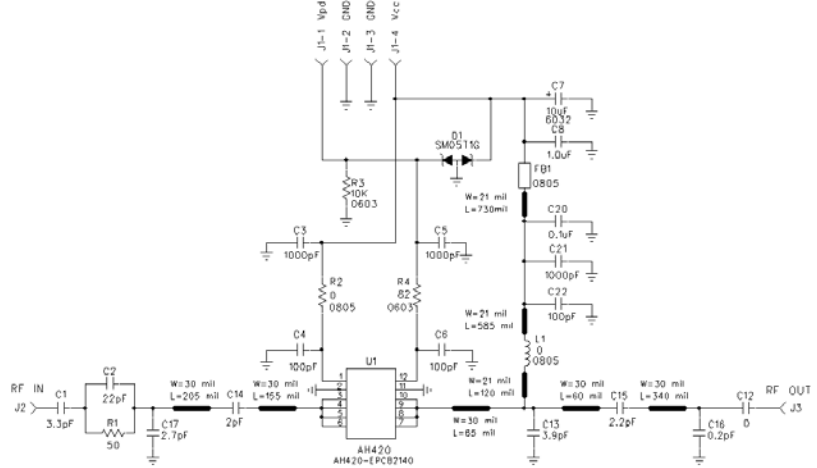
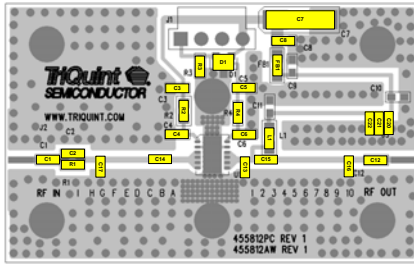

Notes:

1. The primary RF microstrip line is 50 Ω.
2. Do not exceed 5.5V on Vpd and Vcc or damage will occur to D1.
3. Components shown on the silkscreen but not on the schematic are not used.
4. Vpd used for device power down (low=RF off)
5. The edge of C13 is placed at 65mil from AH420 RFout pin. (7.6° @ 2140 MHz)
6. The edge of C15 is placed 60mil from the edge of C13. (7.0° @ 2140 MHz)
7. The edge of C16 is placed 340mil from the edge of C15. (39.9° @ 2140 MHz)
8. The edge of C14 is placed at 155mil from AH420 RFin pin. (18.2° @ 2140 MHz)
9. The edge of C17 is placed 205mil from the edge of C14. (24.0° @ 2140 MHz)
10. 0 Ω jumpers can be replaced with copper trace in target application.

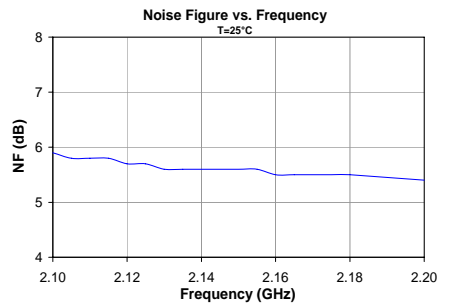
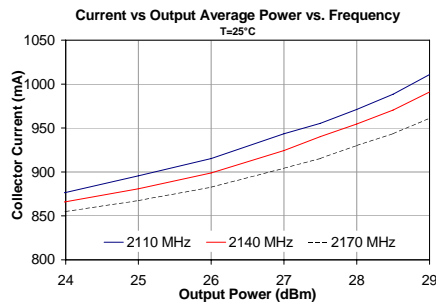
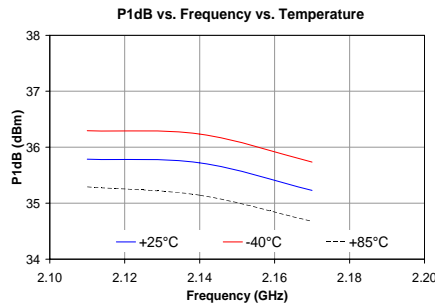
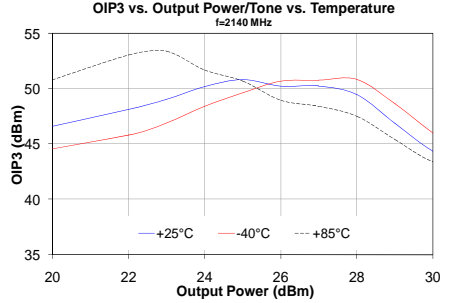
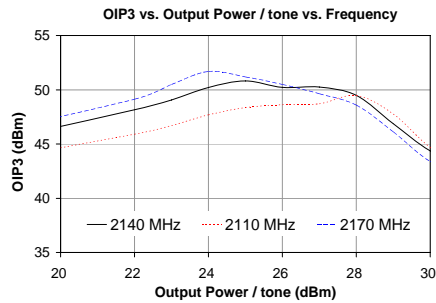
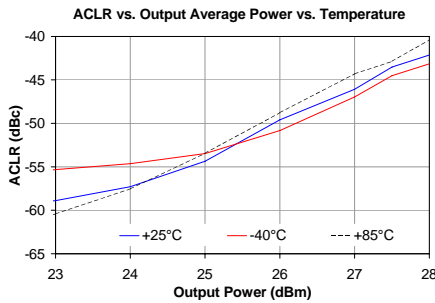
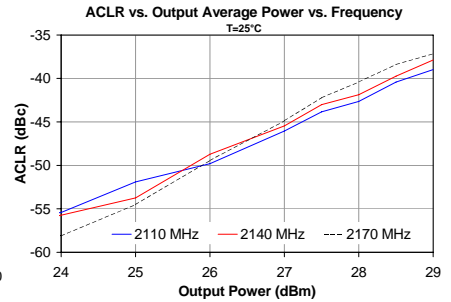
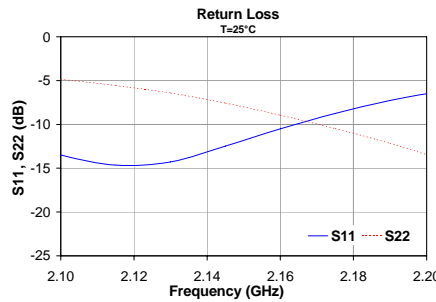
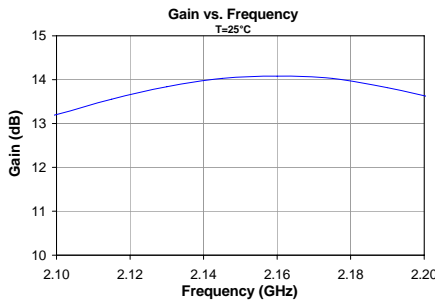

Specifications and information are subject to change without notice

2.3-2.4 GHz Application Circuit Performance Plots

802.16-2004 O-FDMA, 64QAM-1/2, 1024-FFT, 20 symbols and 30 subchannels, 5 MHz Carrier BW

Typical O-FDMA Performance at 25°C

Frequency (GHz)	2.3	2.35	2.4	Units
Channel Power	+27	+27	+27	dBm
Gain	12.8	13.2	13.6	dB
Input Return Loss	18	16	13	dB
Output Return Loss	4	5.2	7.3	dB
EVM	2	1.9	2	%
Operating Current, I _{cc}	955	920	890	mA
Collector Efficiency	10.4	11	11	%
Quiescent Current, I _{cq}	800			mA
V _{cc} , V _{pd}	+5			V

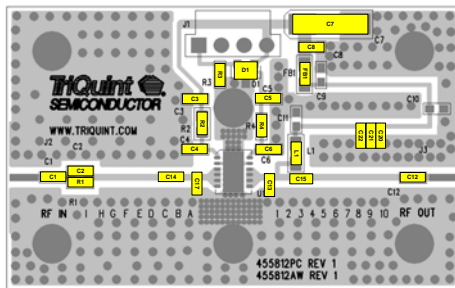

Circuit Board Material: 0.014" GETEK, single layer, 1 oz copper, $\epsilon_r = 4.2$, Microstrip line details: width = .030", spacing = .030"

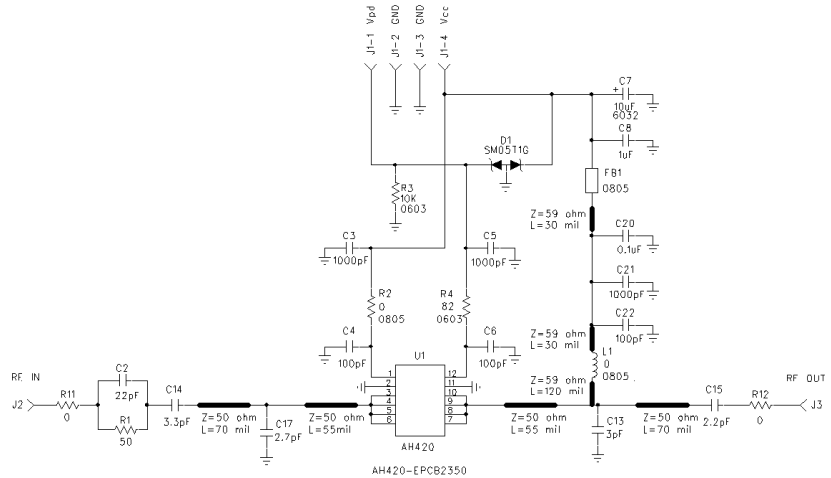

Notes:

1. The primary RF microstrip line is 50 Ω .
2. Do not exceed 5.5V on V_{pd} or V_{cc} or damage to D1 will occur.
3. Components shown on the silkscreen but not on the schematic are not used.
4. C1 & C12 can be replaced with a copper trace.
5. 0 Ω jumpers can be replaced with copper trace in target application.
6. The edge of C17 is placed 55 mil from the AH420 RFin pin. (7.1° @ 2.35 GHz)
7. The edge of C14 is placed 70 mil from the edge of C17. (9.0° @ 2.35 GHz)
8. The edge of C13 is placed 55 mil from the AH420 RFout pin. (7.1° @ 2.35 GHz)
9. The edge of C15 is placed 70 mil from the edge of C13. (9.0° @ 2.35 GHz)

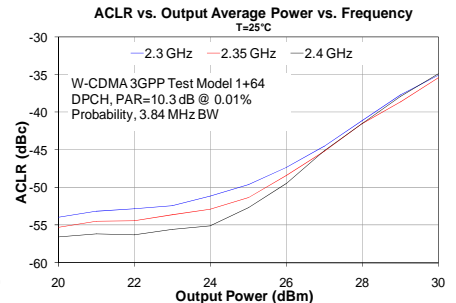
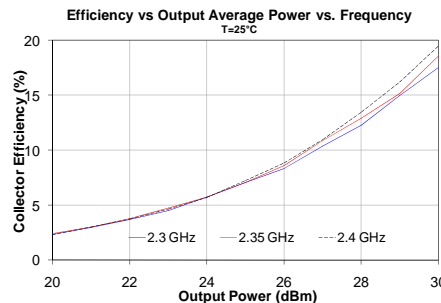
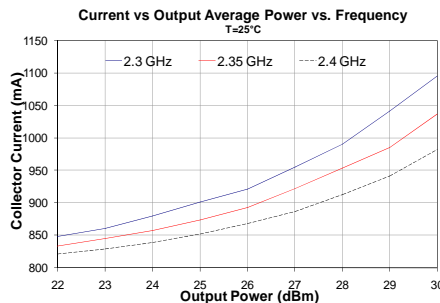
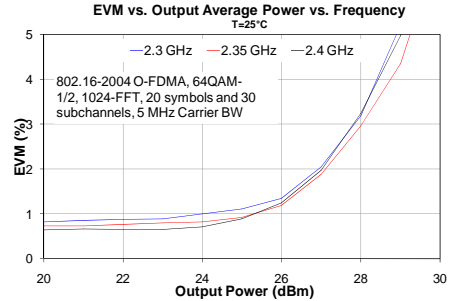
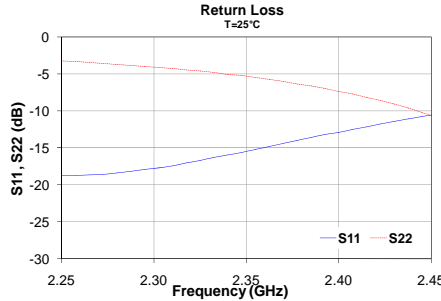
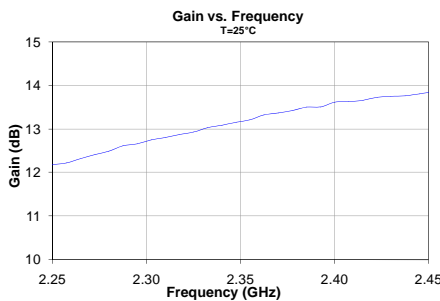

Mechanical Information

This package is lead-free/green/RoHS-compliant. The plating material on the backside metallization is Matte Tin. It is compatible with both lead-free (maximum 260 °C reflow temperature) and lead (maximum 245 °C reflow temperature) soldering processes.

Outline Drawing

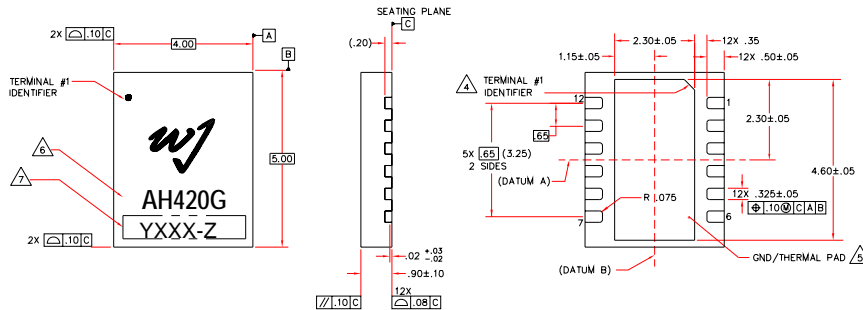

NOTES:

- EXCEPT WHERE NOTED, THIS PART OUTLINE CONFORMS TO JEDEC STANDARD MO-229, ISSUE C (VARIATION VJC) FOR THERMALLY ENHANCED PLASTIC VERY THIN FINE PITCH QUAD FLAT NO LEAD PACKAGE (QFN).
- DIMENSIONING & TOLERANCING CONFORM TO ASME Y14.4M-1994.
- ALL DIMENSIONS ARE IN MILLIMETERS. ANGLES ARE IN DEGREES.

- THE TERMINAL #1 IDENTIFIER AND TERMINAL NUMBERING CONVENTION CONFORM TO JEDEC 95-1 SPP-012.
- COPLANARITY APPLIES TO THE EXPOSED GROUND/THERMAL PAD AS WELL AS THE TERMINALS.
- PART NUMBER
- ALPHA-NUMERIC LOT CODE.

Mounting Configuration / Land Pattern

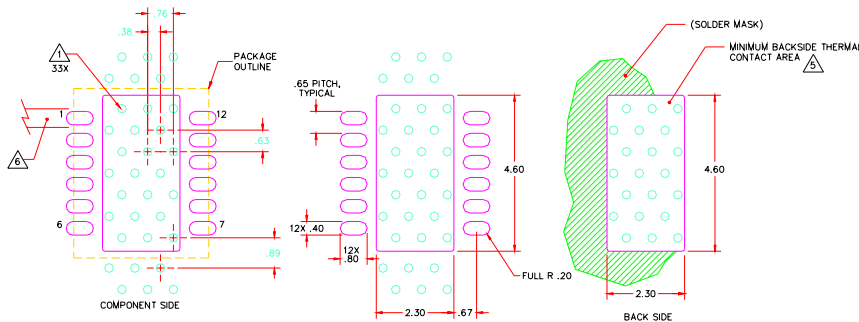

Notes:

- A heatsink underneath the area of the PCB for the mounted device is recommended for proper thermal operation. Damage to the device can occur without the use of one.
- Ground / thermal vias are critical for the proper performance of this device. Vias should use a .35mm (#80 / .0135") diameter drill and have a final plated thru diameter of .25 mm (.010").
- Add as much copper as possible to inner and outer layers near the part to ensure optimal thermal performance.
- Mounting screws can be added near the part to fasten the board to a heatsink. Ensure that the ground / thermal via region contacts the heatsink.
- Do not put solder mask on the backside of the PC board in the region where the board contacts the heatsink.
- RF trace width depends upon the PC board material and construction.
- Use 1 oz. Copper minimum.
- All dimensions are in millimeters

Product Marking

The AH420 will be marked with an "AH420G" designator with a lot code marked below the part designator. The "Y" represents the last digit of the year the part was manufactured, the "XXX" is an auto-generated number, and "Z" refers to a wafer number in a lot batch.

Tape and reel specifications for this part are located on the website in the "Application Notes" section.

ESD / MSL Information



Caution! ESD sensitive device.

ESD Rating: Class 1A
 Value: Passes $\geq 250V$ to $<500V$
 Test: Human Body Model (HBM)
 Standard: JEDEC Standard JESD22-A114

ESD Rating: Class IV
 Value: Passes $\geq 1000V$ min.
 Test: Charged Device Model (CDM)
 Standard: JEDEC Standard JESD22-C101

MSL Rating: Level 3 at +260 °C convection reflow
 Standard: JEDEC Standard J-STD-020

Functional Pin Layout

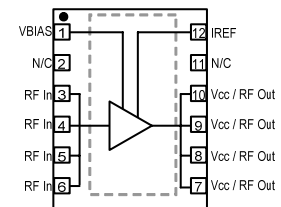

Pin	Function
1	VBIAS
2, 11	No Connect
3, 4, 5, 6	RF Input
7, 8, 9, 10	VCC / RF Output
12	IREF