

### FEATURES

- Qualified for automotive applications
- Fully programmable audio DSP for enhanced sound processing
- Features SigmaStudio, a proprietary graphical programming tool for the development of custom signal flows
- Up to 294.912 MHz, 32-bit SigmaDSP core at 1.2 V
  - Up to 6144 SIMD instructions per sample at 48 kHz
  - Up to 40 kWords of parameter/data RAM
  - Up to 800 ms digital audio delay pool at 48 kHz
- Audio I/O and routing
  - 4 serial input ports, 4 serial output ports
  - 48-channel, 32-bit digital I/O up to a sample rate of 192 kHz
  - Flexible configuration for TDM, I<sup>2</sup>S, left and right justified formats, and PCM
  - Up to 8 stereo ASRCs from 1:8 up to 7.75:1 ratio and 139 dB DNR
  - Stereo S/PDIF input and output (not on the ADAU1450)
  - Four PDM microphone input channels
  - Multichannel, byte addressable TDM serial ports
- Clock oscillator for generating master clock from crystal

- Integer PLL and flexible clock generators
- Integrated die temperature sensor
- I<sup>2</sup>C and SPI control interfaces (both slave and master)
- Standalone operation
  - Self boot from serial EEPROM
  - 6-channel, 10-bit SAR auxiliary control ADC
  - 14 multipurpose pins for digital controls and outputs
- On-chip regulator for generating 1.2 V from 3.3 V supply
- 72-lead, 10 mm × 10 mm LFCSP package with 5.3 mm exposed pad
- Temperature range: -40°C to +105°C

### APPLICATIONS

- Automotive audio processing
  - Head units
  - Navigation systems
  - Rear seat entertainment systems
  - DSP amplifiers (sound system amplifiers)
- Commercial and professional audio processing

### FUNCTIONAL BLOCK DIAGRAM—ADAU1452/ADAU1451

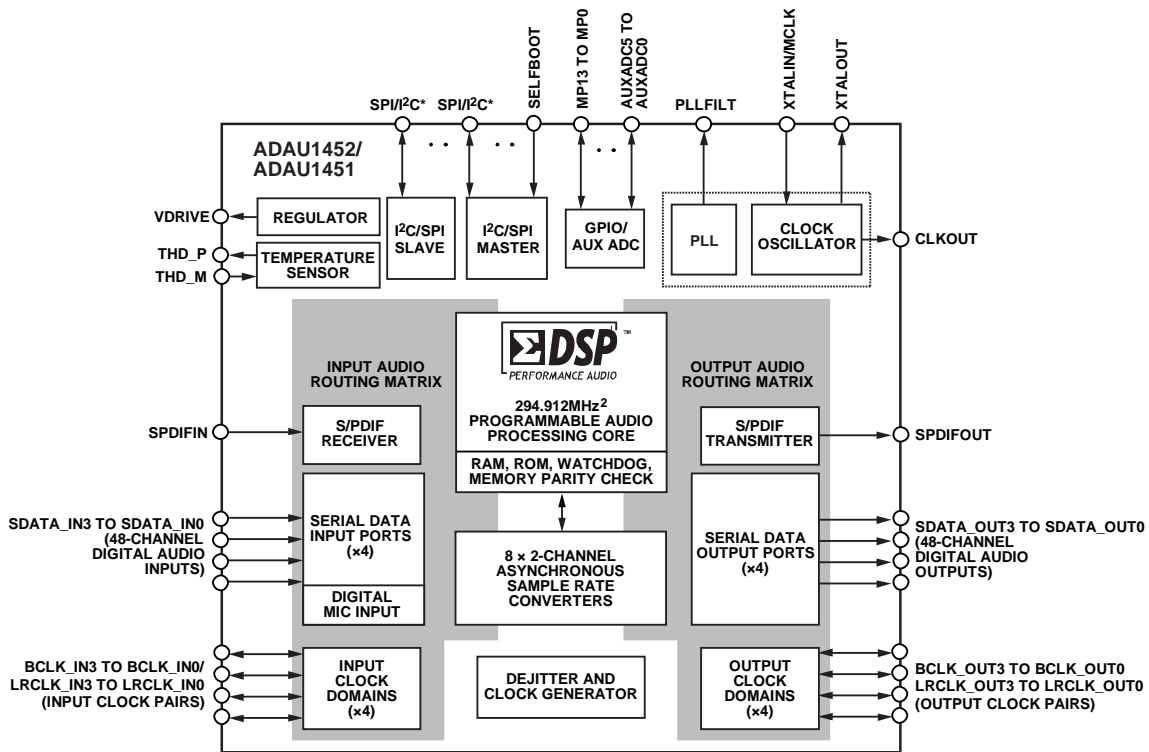

\*SPI/I<sup>2</sup>C INCLUDES THE FOLLOWING PIN FUNCTIONS: SS\_M, MOSI\_M, SCL\_M, SCLK\_M, SDA\_M, MISO\_M, MISO, SDA, SCLK, SCL, MOSI, ADDR1, SS, AND ADDR0 PINS.

Figure 1.

Rev. C

[Document Feedback](#)

Information furnished by Analog Devices is believed to be accurate and reliable. However, no responsibility is assumed by Analog Devices for its use, nor for any infringements of patents or other rights of third parties that may result from its use. Specifications subject to change without notice. No license is granted by implication or otherwise under any patent or patent rights of Analog Devices. Trademarks and registered trademarks are the property of their respective owners.

One Technology Way, P.O. Box 9106, Norwood, MA 02062-9106, U.S.A.  
 Tel: 781.329.4700 ©2013–2014 Analog Devices, Inc. All rights reserved.  
[Technical Support](#) [www.analog.com](http://www.analog.com)

**TABLE OF CONTENTS**

Features .....	1	Auxiliary ADC.....	76
Applications.....	1	SigmaDSP Core .....	76
Functional Block Diagram—ADAU1452/ADAU1451 .....	1	Software Features .....	80
Revision History .....	3	Pin Drive Strength, Slew Rate, and Pull Configuration .....	81
General Description .....	4	Global RAM and Control Register Map.....	83
Differences Between the ADAU1452, ADAU1451, and ADAU1450.....	4	Random Access Memory .....	83
Functional Block Diagram—ADAU1450 .....	5	Control Registers.....	84
Specifications.....	6	Control Register Details .....	94
Electrical Characteristics .....	8	PLL Configuration Registers .....	94
Timing Specifications .....	9	Clock Generator Registers .....	98
Absolute Maximum Ratings.....	17	Power Reduction Registers .....	102
Thermal Characteristics .....	17	Audio Signal Routing Registers.....	105
Maximum Power Dissipation .....	17	Serial Port Configuration Registers.....	111
ESD Caution.....	17	Flexible TDM Interface Registers.....	114
Pin Configuration and Function Descriptions.....	18	DSP Core Control Registers.....	118
Theory of Operation .....	22	Debug and Reliability Registers.....	123
System Block Diagram.....	22	DSP Program Execution Registers.....	131
Overview.....	22	Multipurpose Pin Configuration Registers .....	135
Initialization .....	24	ASRC Status and Control Registers .....	140
Master Clock, PLL, and Clock Generators.....	27	Auxiliary ADC Registers.....	143
Power Supplies, Voltage Regulator, and Hardware Reset.....	32	S/PDIF Interface Registers .....	144
Temperature Sensor Diode.....	33	Hardware Interfacing Registers .....	157
Slave Control Ports.....	34	Soft Reset Register.....	175
Master Control Ports.....	40	Applications Information .....	176
Self Boot.....	41	PCB Design Considerations .....	176
Audio Signal Routing.....	43	Typical Applications Block Diagram .....	177
Serial Data Input/Output.....	53	Example PCB Layout .....	178
Flexible TDM Interface.....	64	PCB Manufacturing Guidelines .....	179
Asynchronous Sample Rate Converters .....	69	Outline Dimensions .....	180
S/PDIF Interface .....	70	Ordering Guide .....	180
Digital PDM Microphone Interface.....	72	Automotive Products.....	180
Multipurpose Pins .....	73		

**REVISION HISTORY****7/14—Rev. B to Rev. C**

Changes to SCL_M/SCLK_M/MP2 Pin Description, Table 23 .....	19
Change to PLL Lock Register Section .....	96
Changes to Ordering Guide .....	180

**5/14—Rev. A to Rev. B**

Reorganized Layout .....	Universal
Added ADAU1452 and ADAU1451 .....	Universal
Changes to Features Section .....	1
Moved Revision History Section .....	3
Changes to General Description Section .....	4
Added Differences Between the ADAU1452, ADAU1451, and ADAU1450 Section and Table 1, Renumbered Sequentially .....	4
Added Functional Block Diagram—ADAU1450 Section and Figure 2, Renumbered Sequentially .....	5
Changes to Table 2 .....	6
Changes to Table 3 .....	7
Changes to Table 6 .....	9
Changes to Maximum Power Dissipation Section, Table 19, and Table 20 .....	17
Added Table 21 and Table 22 .....	17
Changes to Figure 12 and Table 23 .....	18
Changes to Overview Section .....	22
Change to Clocking Overview Section and Power-Up Sequence Section .....	24
Changes to Setting the Master Clock and PLL Mode Section ..	27
Changes to Example PLL Settings Section and Table 25 .....	28
Changed PLL Loop Filter Section to PLL Filter Section .....	29
Changes to PLL Filter Section, Figure 17 Caption, and Table 26 .....	29

Changes to Clock Generators Section .....	30
Changes to Master Clock Output Section .....	31
Changes to I <sup>2</sup> C Slave Port Section .....	35
Changes to Audio Signal Routing Section .....	43
Changes to Serial Audio Inputs to DSP Core Section .....	44
Changes to Asynchronous Sample Rate Converter Input Routing Section .....	49
Change to Serial Input Ports Section .....	61
Changes to Asynchronous Sample Rate Converters Section ..	68
Changes to S/PDIF Interface Section and S/PDIF Receiver Section .....	69
Changes to Auxiliary Output Mode Section .....	70
Change to Digital PDM Microphone Interface Section .....	71
Changes to SigmaDSP Core Section .....	76
Changes to Soft Reset Function Section .....	81
Changes to Random Access Memory Section .....	83
Added Table 62 and Table 63 .....	83
Changes to Table 84 .....	109
Changed PLL Loop Filter Section to PLL Filter Section .....	176
Change to EOS/ESD Protection Section .....	177
Change to PCB Manufacturing Guidelines Section .....	179
Changes to Ordering Guide .....	180

**1/14—Rev. 0 to Rev. A**

Changed S/PDIF Transceiver and Receiver Maximum Audio Sample Rate from 192 kHz to 96 kHz; Table 9 and Table 10 .....	9
---	---

**10/13—Revision 0: Initial Version**

## GENERAL DESCRIPTION

The [ADAU1452/ADAU1451/ADAU1450](#) are automotive qualified audio processors that far exceed the digital signal processing capabilities of earlier SigmaDSP® devices. The restructured hardware architecture is optimized for efficient audio processing. The audio processing algorithms are realized in sample-by-sample and block-by-block paradigms that can both be executed simultaneously in a signal processing flow created using the graphical programming tool, SigmaStudio™. The restructured digital signal processor (DSP) core architecture enables some types of audio processing algorithms to be executed using significantly fewer instructions than were required on previous SigmaDSP generations, leading to vastly improved code efficiency.

The 1.2 V, 32-bit DSP core can run at frequencies of up to 294.912 MHz and execute up to 6144 instructions per sample at the standard sample rate of 48 kHz. However, in addition to industry standard rates, a wide range of sample rates are available. The integer PLL and flexible clock generator hardware can generate up to 15 audio sample rates simultaneously. These clock generators, along with the on board asynchronous sample rate converters (ASRCs) and a flexible hardware audio routing matrix, make the [ADAU1452/ADAU1451/ADAU1450](#) ideal audio hubs that greatly simplify the design of complex multirate audio systems.

The [ADAU1452/ADAU1451/ADAU1450](#) interface with a wide range of ADCs, DACs, digital audio devices, amplifiers, and control circuitry, due to their highly configurable serial ports, S/PDIF interfaces (on the [ADAU1452](#) and [ADAU1451](#)), and multipurpose input/output pins. They can also directly interface with PDM output MEMS microphones, thanks to integrated decimation filters specifically designed for that purpose.

Independent slave and master I<sup>2</sup>C/SPI control ports allow the [ADAU1452/ADAU1451/ADAU1450](#) not only to be programmed and configured by an external master device, but also to act as masters that can program and configure external slave devices directly. This flexibility, combined with self boot functionality, enables the design of standalone systems that do not require any external input to operate.

The power efficient DSP core executes full programs while consuming only a few hundred milliwatts (mW) of power and can run at a maximum program load while consuming less than a watt, even in worst case temperatures exceeding 100°C. This relatively low power consumption and small footprint make the [ADAU1452/ADAU1451/ADAU1450](#) ideal replacements for large, general-purpose DSPs that consume more power at the same processing load.

### DIFFERENCES BETWEEN THE [ADAU1452](#), [ADAU1451](#), AND [ADAU1450](#)

The three variants of this device are differentiated by memory, DSP core frequency, availability of S/PDIF interfaces, and ASRC configuration. A detailed summary of the differences is listed in Table 1.

Because the [ADAU1450](#) does not contain an S/PDIF receiver or transmitter, the SPDIFIN and SPDIFOUT pins are nonfunctional. Also, the settings of any registers related to the S/PDIF input or output in the [ADAU1450](#) do not have any effect on the operation of the device.

Likewise, because the [ADAU1450](#) does not contain ASRCs, the settings of any registers related to the ASRCs in the [ADAU1450](#) do not have any effect on the operation of the device.

**Table 1. Product Selection Table**

Device Number	Data Memory (kWords)	Program Memory (kWords)	DSP Core Frequency	S/PDIF Input and Output	ASRC Configuration
<a href="#">ADAU1452</a>	40	8	294.912 MHz	Available	16 channels (8 rates × 2 channels per rate)
<a href="#">ADAU1451</a>	16	8	294.912 MHz	Available	16 channels (8 rates × 2 channels per rate)
<a href="#">ADAU1450</a>	8	8	147.456 MHz	Not available	No ASRCs included



FUNCTIONAL BLOCK DIAGRAM—ADAU1450

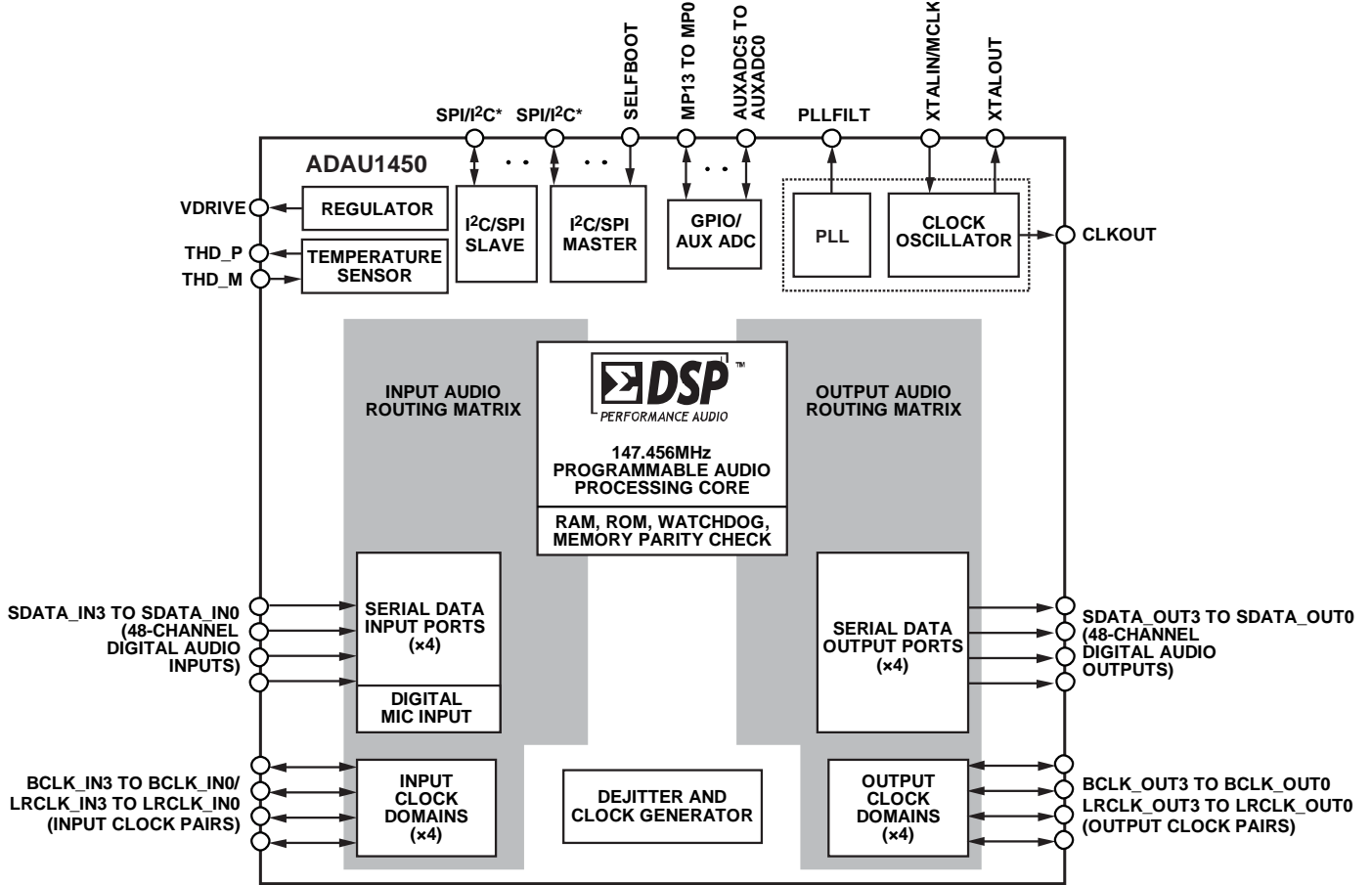

\*SPI/I<sup>2</sup>C INCLUDES THE FOLLOWING PIN FUNCTIONS: SS\_M, MOSI\_M, SCL\_M, SCLK\_M, SDA\_M, MISO\_M, MISO, SDA, SCLK, SCL, MOSI, ADDR1, SS, AND ADDR0 PINS.

Figure 2.

11486-101

**SPECIFICATIONS**

AVDD = 3.3 V ± 10%, DVDD = 1.2 V ± 5%, PVDD = 3.3 V ± 10%, IOVDD = 1.8 V – 10% to 3.3 V + 10%, T<sub>A</sub> = 25°C, master clock input = 12.288 MHz, core clock (f<sub>CORE</sub>) = 294.912 MHz, I/O pins set to low drive setting, unless otherwise noted.

**Table 2.**

Parameter	Min	Typ	Max	Unit	Test Conditions/Comments
<b>POWER</b>					
Supply Voltage					
Analog Voltage (AVDD)	2.97	3.3	3.63	V	Supply for analog circuitry, including auxiliary ADC
Digital Voltage (DVDD)	1.14	1.2	1.26	V	Supply for digital circuitry, including the DSP core, ASRCs, and signal routing
PLL Voltage (PVDD)	2.97	3.3	3.63	V	Supply for phase-locked loop (PLL) circuitry
I/O Supply Voltage (IOVDD)	1.71	3.3	3.63	V	Supply for input/output circuitry, including pads and level shifters
Supply Current					
Analog Current (AVDD)					
Idle State	0	5	40	µA	Power applied, chip not programmed
Reset State	1.9	6.5	40	µA	Power applied, RESET held low
PLL Current (PVDD)					
Idle State	0	7.3	40	µA	Power applied, PLL not configured
Reset State	3.9	8.5	40	µA	Power applied, RESET held low
I/O Current (IOVDD)					
Operation State		53		mA	IOVDD = 3.3 V; all serial ports are clock masters
		22		mA	IOVDD = 1.8 V; all serial ports are clock masters
Power-Down State		0.3	2.5	mA	IOVDD = 1.8 V – 10% to 3.3 V + 10%
Digital Current (DVDD)					
Operation State, <a href="#">ADAU1452</a>					
Maximum Program		350	415	mA	
Typical Program		100		mA	Test program includes 16-channel I/O, 10-band EQ per channel, all ASRCs active
Minimal Program		85		mA	Test program includes 2-channel I/O, 10-band EQ per channel
Operation State, <a href="#">ADAU1451</a>					
Maximum Program		350	415	mA	
Typical Program		100		mA	Test program includes 16-channel I/O, 10-band EQ per channel, all ASRCs active
Minimal Program		85		mA	Test program includes 2-channel I/O, 10-band EQ per channel
Operation State, <a href="#">ADAU1450</a>					
Maximum Program		125	250	mA	f <sub>CORE</sub> = 147.456 MHz
Typical Program		65		mA	Test program includes 16-channel I/O, 10-band EQ per channel, f <sub>CORE</sub> = 147.456 MHz
Minimal Program		55		mA	Test program includes 2-channel I/O, 10-band EQ per channel, f <sub>CORE</sub> = 147.456 MHz
Idle State		20	95	mA	Power applied, DSP not enabled
Reset State		20	95	mA	Power applied, RESET held low
<b>ASYNCHRONOUS SAMPLE RATE CONVERTERS</b>					
Dynamic Range		139		dB	A-weighted, 20 Hz to 20 kHz
I/O Sample Rate	6		192	kHz	
I/O Sample Rate Ratio	1:8		7.75:1		
THD + N			-120	dB	
<b>CRYSTAL OSCILLATOR</b>					
Transconductance	8.3	10.6	13.4	mS	
<b>REGULATOR</b>					
DVDD Voltage	1.14	1.2		V	Regulator maintains typical output voltage up to a maximum 800 mA load; IOVDD = 1.8 V – 10% to 3.3 V + 10%

AVDD = 3.3 V ± 10%, DVDD = 1.2 V ± 5%, PVDD = 3.3 V ± 10%, IOVDD = 1.8 V – 10% to 3.3 V + 10%, T<sub>A</sub> = –40°C to +105°C, master clock input = 12.288 MHz, core clock (f<sub>CORE</sub>) = 294.912 MHz, I/O pins set to low drive setting, unless otherwise noted.

Table 3.

Parameter	Min	Typ	Max	Unit	Test Conditions/Comments
<b>POWER</b>					
Supply Voltage					
Analog Voltage (AVDD)	2.97	3.3	3.63	V	Supply for analog circuitry, including auxiliary ADC
Digital Voltage (DVDD)	1.14	1.2	1.26	V	Supply for digital circuitry, including the DSP core, ASRCs, and signal routing
PLL Voltage (PVDD)	2.97	3.3	3.63	V	Supply for PLL circuitry
IOVDD Voltage (IOVDD)	1.71	3.3	3.63	V	Supply for input/output circuitry, including pads and level shifters
Supply Current					
Analog Current (AVDD)					
Idle State	0	6.3	40	µA	
Reset State	0.26	7.1	40	µA	
PLL Current (PVDD)					
Idle State	6	10.9	15	mA	12.288 MHz master clock; default PLL settings
Reset State	0	7.8	40	µA	Power applied, PLL not configured
	1.2	9.3	40	µA	Power applied, $\overline{\text{RESET}}$ held low
I/O Current (IOVDD)					
Operation State					
		47		mA	IOVDD = 3.3 V; all serial ports are clock masters
		15		mA	IOVDD = 1.8 V; all serial ports are clock masters
Power-Down State					
		1.3	2.2	mA	IOVDD = 1.8 V – 10% to 3.3 V + 10%
Digital Current (DVDD)					
Operation State, <a href="#">ADAU1452</a>					
Maximum Program		500	690	mA	
Typical Program		200		mA	Test program includes 16-channel I/O, 10-band EQ per channel, all ASRCs active
Minimal Program		160		mA	Test program includes 2-channel I/O, 10-band EQ per channel
Operation State, <a href="#">ADAU1451</a>					
Maximum Program		500	690	mA	
Typical Program		200		mA	Test program includes 16-channel I/O, 10-band EQ per channel, all ASRCs active
Minimal Program		160		mA	Test program includes 2-channel I/O, 10-band EQ per channel
Operation State, <a href="#">ADAU1450</a>					
Maximum Program		270	635	mA	f <sub>CORE</sub> = 147.456 MHz
Typical Program		110		mA	Test program includes 16-channel I/O, 10-band EQ per channel, f <sub>CORE</sub> = 147.456 MHz
Minimal Program		90		mA	Test program includes 2-channel I/O, 10-band EQ per channel, f <sub>CORE</sub> = 147.456 MHz
Idle State		315	635	mA	
Reset State		315	635	mA	
<b>ASYNCHRONOUS SAMPLE RATE CONVERTERS</b>					
Dynamic Range					
		139		dB	A-weighted, 20 Hz to 20 kHz
I/O Sample Rate					
	6		192	kHz	
I/O Sample Rate Ratio					
	1:8		7.75:1		
THD + N					
			–120	dB	
<b>CRYSTAL OSCILLATOR</b>					
Transconductance					
	8.1	10.6	14.6	mS	
<b>REGULATOR</b>					
DVDD Voltage					
	1.14	1.2		V	Regulator maintains typical output voltage up to a maximum 800 mA load; IOVDD = 1.8 V – 10% to 3.3 V + 10%

**ELECTRICAL CHARACTERISTICS**

**Digital Input/Output**

Table 4.

Parameter	Min	Typ	Max	Unit	Test Conditions/Comments
<b>DIGITAL INPUT</b>					
Input Voltage					
IOVDD = 3.3 V					
High Level ( $V_{IH}$ ) <sup>1</sup>	1.71		3.3	V	
Low Level ( $V_{IL}$ ) <sup>1</sup>	0		1.71	V	
IOVDD = 1.8 V					
High Level ( $V_{IH}$ ) <sup>1</sup>	0.92		1.8	V	
Low Level ( $V_{IL}$ ) <sup>1</sup>	0		0.89	V	
Input Leakage					
High Level ( $I_{IH}$ )	-2		+2	μA	Digital input pins with pull-up resistor
	2		12	μA	Digital input pins with pull-down resistor
	-2		+2	μA	Digital input pins with no pull resistor
	0		8	μA	MCLK
	80		120	μA	SPDIFIN
Low Level ( $I_{IL}$ ) at 0 V	-12		-2	μA	Digital input pins with pull-up resistor
	-2		+2	μA	Digital input pins with pull-down resistor
	-2		+2	μA	Digital input pins with no pull resistor
	-8		0	μA	MCLK
	-120		-77	μA	SPDIFIN
Input Capacitance (C <sub>i</sub> )		2		pF	Guaranteed by design
<b>DIGITAL OUTPUT</b>					
Output Voltage					
IOVDD = 3.3 V					
High Level ( $V_{OH}$ )	3.09		3.3	V	$I_{OH} = 1\text{ mA}$
Low Level ( $V_{OL}$ )	0		0.26	V	$I_{OL} = 1\text{ mA}$
IOVDD = 1.8 V					
High Level ( $V_{OH}$ )	1.45		1.8		
Low Level ( $V_{OL}$ )	0		0.33		
Digital Output Pins, Output Drive					The digital output pins are driving low impedance PCB traces to a high impedance digital input buffer
IOVDD = 1.8 V					
Drive Strength Setting					
Lowest			1	mA	The digital output pins are not designed for static current draw; do not use these pins to drive LEDs directly
Low			2	mA	The digital output pins are not designed for static current draw; do not use these pins to drive LEDs directly
High			3	mA	The digital output pins are not designed for static current draw; do not use these pins to drive LEDs directly
Highest			5	mA	The digital output pins are not designed for static current draw; do not use these pins to drive LEDs directly
IOVDD = 3.3 V					
Drive Strength Setting					
Lowest			2	mA	The digital output pins are not designed for static current draw; do not use these pins to drive LEDs directly
Low			5	mA	The digital output pins are not designed for static current draw; do not use these pins to drive LEDs directly
High			10	mA	The digital output pins are not designed for static current draw; do not use these pins to drive LEDs directly
Highest			15	mA	The digital output pins are not designed for static current draw; do not use these pins to drive LEDs directly

<sup>1</sup> Digital input pins except SPDIFIN, which is not a standard digital input.

**Auxiliary ADC**

T<sub>A</sub> = -40°C to +105°C, DVDD = 1.2 V ± 5%, AVDD = 3.3 V ± 10%, IOVDD = 1.8 V - 10% to 3.3 V + 10%, unless otherwise noted.

Table 5.

Parameter	Min	Typ	Max	Unit
RESOLUTION		10		Bits
FULL-SCALE ANALOG INPUT		AVDD		V
NONLINEARITY				
Integrated Nonlinearity (INL)	-2		+2	LSB
Differential Nonlinearity (DNL)	-2		+2	LSB
GAIN ERROR	-2		+2	LSB
INPUT IMPEDANCE		200		kΩ
SAMPLE RATE		f <sub>CORE</sub> /6144		Hz

**TIMING SPECIFICATIONS**

**Master Clock Input**

T<sub>A</sub> = -40°C to +105°C, DVDD = 1.2 V ± 5%, IOVDD = 1.8 V - 10% to 3.3 V + 10%, unless otherwise noted.

Table 6.

Parameter	Min	Max	Unit	Description
MASTER CLOCK INPUT (MCLK)				
f <sub>MCLK</sub>	2.375	36	MHz	MCLK frequency
t <sub>MCLK</sub>	27.8	421	ns	MCLK period
t <sub>MCLKD</sub>	25	75	%	MCLK duty cycle
t <sub>MCLKH</sub>	0.25 × t <sub>MCLK</sub>	0.75 × t <sub>MCLK</sub>	ns	MCLK width high
t <sub>MCLKL</sub>	0.25 × t <sub>MCLK</sub>	0.75 × t <sub>MCLK</sub>	ns	MCLK width low
CLKOUT Jitter	12	106	ps	Cycle-to-cycle rms average
CORE CLOCK				
f <sub>CORE</sub>				
ADAU1452 and ADAU1451	152	294.912	MHz	System (DSP core) clock frequency; PLL feedback divider ranges from 64 to 108
ADAU1450	76	147.456	MHz	System (DSP core) clock frequency; PLL feedback divider ranges from 64 to 108
t <sub>CORE</sub>				
ADAU1452 and ADAU1451	3.39		ns	System (DSP core) clock period
ADAU1450	6.78		ns	System (DSP core) clock period

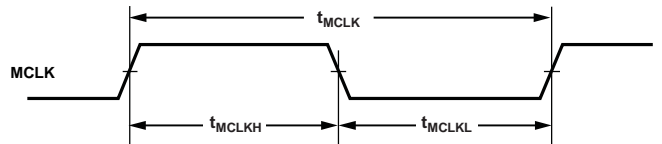

Figure 3. Master Clock Input Timing Specifications

**Reset**

T<sub>A</sub> = -40°C to +105°C, DVDD = 1.2 V ± 5%, IOVDD = 1.8 V - 10% to 3.3 V + 10%.

Table 7.

Parameter	Min	Max	Unit	Description
RESET				
t <sub>WRST</sub>	10		ns	Reset pulse width low

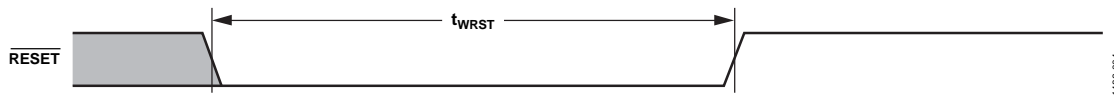

Figure 4. Reset Timing Specification

**Serial Ports**

T<sub>A</sub> = -40°C to +105°C, DVDD = 1.2 V ± 5%, IOVDD = 1.8 V - 10% to 3.3 V + 10%, unless otherwise noted. BCLK in Table 8 refers to BCLK\_OUT3 to BCLK\_OUT0 and BCLK\_IN3 to BCLK\_IN0. LRCLK refers to LRCLK\_OUT3 to LRCLK\_OUT0 and LRCLK\_IN3 to LRCLK\_IN0.

**Table 8.**

Parameter	Min	Max	Unit	Description
<b>SERIAL PORT</b>				
f <sub>LRCLK</sub>		192	kHz	LRCLK frequency
t <sub>LRCLK</sub>	5.21		µs	LRCLK period
f <sub>BCLK</sub>		24.576	MHz	BCLK frequency, sample rate ranging from 6 kHz to 192 kHz
t <sub>BCLK</sub>	40.7		ns	BCLK period
t <sub>BIL</sub>	10		ns	BCLK low pulse width, slave mode; BCLK frequency = 24.576 MHz; BCLK period = 40.6 ns
t <sub>BIH</sub>	14.5		ns	BCLK high pulse width, slave mode; BCLK frequency = 24.576 MHz; BCLK period = 40.6 ns
t <sub>LIS</sub>	20		ns	LRCLK setup to BCLK_INx input rising edge, slave mode; LRCLK frequency = 192 kHz
t <sub>LH</sub>	5		ns	LRCLK hold from BCLK_INx input rising edge, slave mode; LRCLK frequency = 192 kHz
t <sub>SIS</sub>	5		ns	SDATA_INx setup to BCLK_INx input rising edge
t <sub>SIH</sub>	5		ns	SDATA_INx hold from BCLK_INx input rising edge
t <sub>TS</sub>		10	ns	BCLK_OUTx output falling edge to LRCLK_OUTx output timing skew, slave
t <sub>SODS</sub>		35	ns	SDATA_OUTx delay in slave mode from BCLK_OUTx output falling edge; serial outputs function in slave mode at all valid sample rates, provided that the external circuit design provides sufficient electrical signal integrity
t <sub>SODM</sub>		10	ns	SDATA_OUTx delay in master mode from BCLK_OUTx output falling edge
t <sub>TM</sub>		5	ns	BCLK falling edge to LRCLK timing skew, master

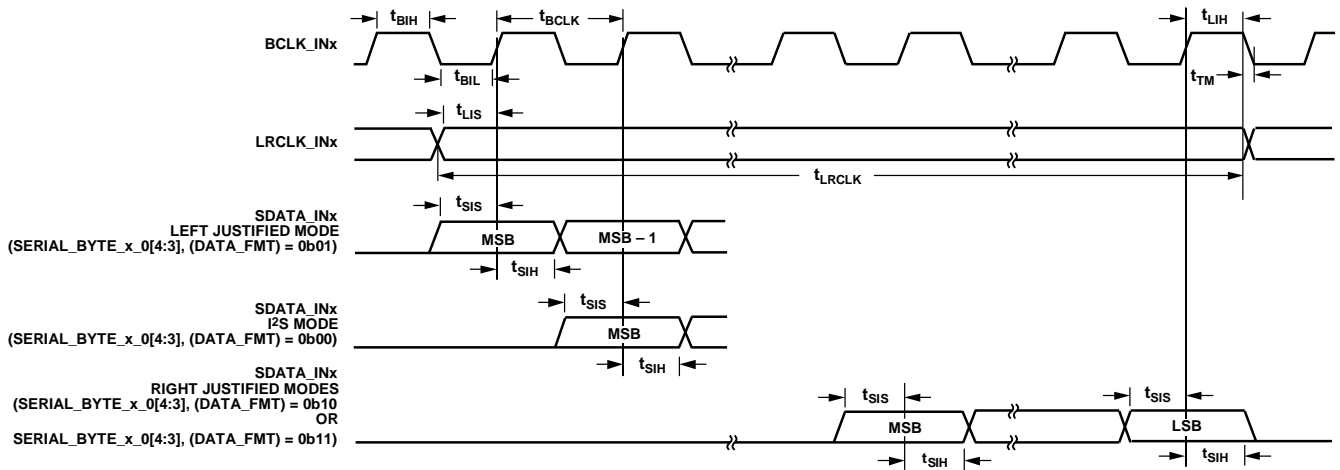

Figure 5. Serial Input Port Timing Specifications

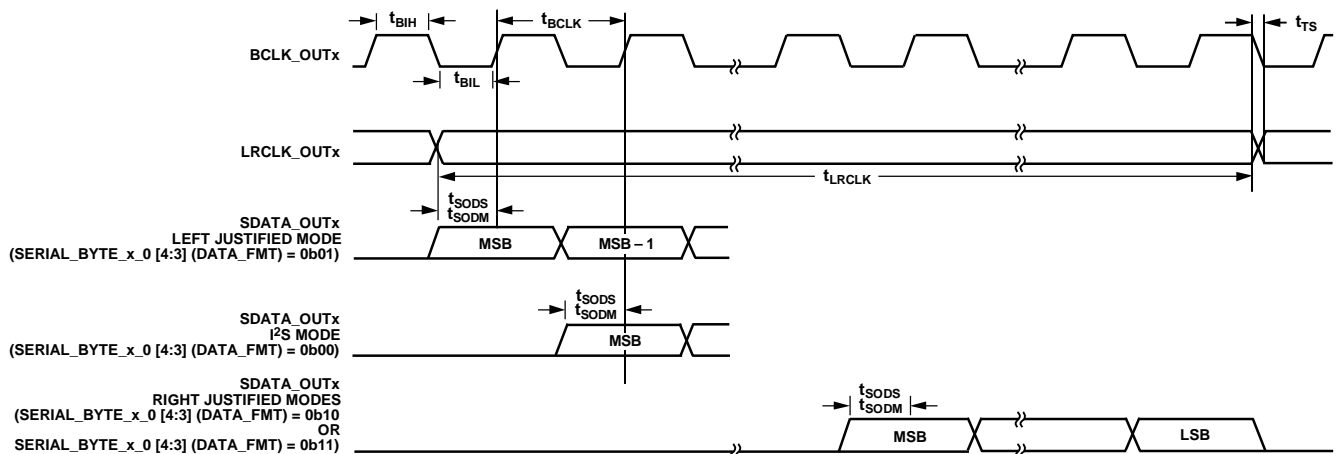

Figure 6. Serial Output Port Timing Specifications

**Multipurpose Pins**

$T_A = -40^{\circ}\text{C}$  to  $+105^{\circ}\text{C}$ ,  $DVDD = 1.2\text{ V} \pm 5\%$ ,  $IOVDD = 1.8\text{ V} - 10\%$  to  $3.3\text{ V} + 10\%$ .

**Table 9.**

Parameter	Min	Max	Unit	Description
MULTIPURPOSE PINS (MPx) $f_{MP}^1$		24.576	MHz	MPx maximum switching rate when pin is configured as a general-purpose input or general-purpose output
$t_{MPIL}^1$	$10 \times t_{CORE}$	$6144 \times t_{CORE}$	sec	MPx pin input latency until high/low value is read by core; the duration in the Max column is equal to the period of one audio sample when the DSP is processing 6144 instructions per sample

<sup>1</sup> Guaranteed by design.

**S/PDIF Transmitter**

$T_A = -40^{\circ}\text{C}$  to  $+105^{\circ}\text{C}$ ,  $DVDD = 1.2\text{ V} \pm 5\%$ ,  $IOVDD = 1.8\text{ V} - 10\%$  to  $3.3\text{ V} + 10\%$ .

**Table 10.**

Parameter	Min	Max	Unit	Description
S/PDIF Transmitter Audio Sample Rate	18	96	kHz	Audio sample rate of data output from S/PDIF transmitter

**S/PDIF Receiver**

$T_A = -40^{\circ}\text{C}$  to  $+105^{\circ}\text{C}$ ,  $DVDD = 1.2\text{ V} \pm 5\%$ ,  $IOVDD = 1.8\text{ V} - 10\%$  to  $3.3\text{ V} + 10\%$ .

**Table 11.**

Parameter	Min	Max	Unit	Description
S/PDIF Receiver Audio Sample Rate	18	96	kHz	Audio sample rate of data input to S/PDIF receiver

**I<sup>2</sup>C Interface—Slave**

T<sub>A</sub> = -40°C to +105°C, DVDD = 1.2 V ± 5%, IOVDD = 1.8 V - 10% to 3.3 V + 10%, default drive strength (f<sub>SCL</sub>) = 400 kHz.

**Table 12.**

Parameter	Min	Max	Unit	Description
<b>I<sup>2</sup>C SLAVE PORT</b>				
f <sub>SCL</sub>		400	kHz	SCL clock frequency
t <sub>SCLH</sub>	0.6		μs	SCL pulse width high
t <sub>SCLL</sub>	1.3		μs	SCL pulse width low
t <sub>SCS</sub>	0.6		μs	Start and repeated start condition setup time
t <sub>SCH</sub>	0.6		μs	Start condition hold time
t <sub>DS</sub>	100		ns	Data setup time
t <sub>DH</sub>	0.9		μs	Data hold time
t <sub>SCLR</sub>		300	ns	SCL rise time
t <sub>SCLF</sub>		300	ns	SCL fall time
t <sub>SDR</sub>		300	ns	SDA rise time
t <sub>SDF</sub>		300	ns	SDA fall time
t <sub>BFT</sub>	1.3		μs	Bus-free time between stop and start
t <sub>SUSTO</sub>	0.6		μs	Stop condition setup time

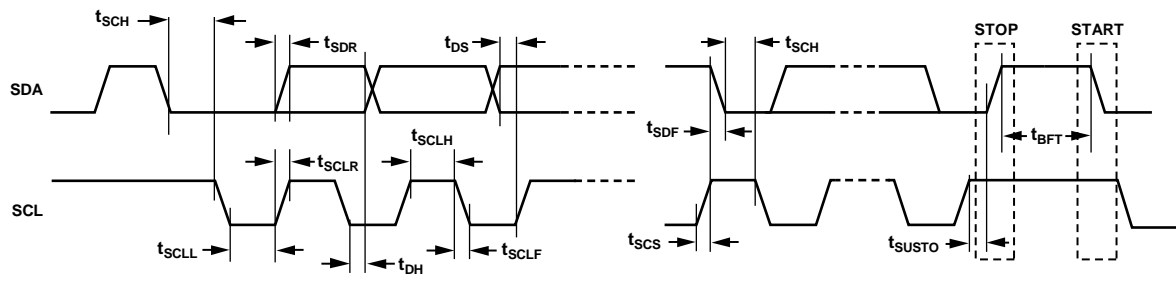

Figure 7. I<sup>2</sup>C Slave Port Timing Specifications

11488-007



**I<sup>2</sup>C Interface—Master**

T<sub>A</sub> = -40°C to +105°C, DVDD = 1.2 V ± 5%, IOVDD = 1.8 V - 10% to 3.3 V + 10%.

**Table 13.**

Parameter	Min	Max	Unit	Description
<b>I<sup>2</sup>C MASTER PORT</b>				
f <sub>SCL</sub>		400	kHz	SCL clock frequency
t <sub>SCLH</sub>	0.6		μs	SCL pulse width high
t <sub>SCLL</sub>	1.3		μs	SCL pulse width low
t <sub>SCS</sub>	0.6		μs	Start and repeated start condition setup time
t <sub>SCH</sub>	0.6		μs	Start condition hold time
t <sub>DS</sub>	100		ns	Data setup time
t <sub>DH</sub>	0.9		μs	Data hold time
t <sub>SCLR</sub>		300	ns	SCL rise time
t <sub>SCLF</sub>		300	ns	SCL fall time
t <sub>SDR</sub>		300	ns	SDA rise time
t <sub>SDF</sub>		300	ns	SDA fall time
t <sub>BFT</sub>	1.3		μs	Bus-free time between stop and start
t <sub>SUSTO</sub>	0.6		μs	Stop condition setup time

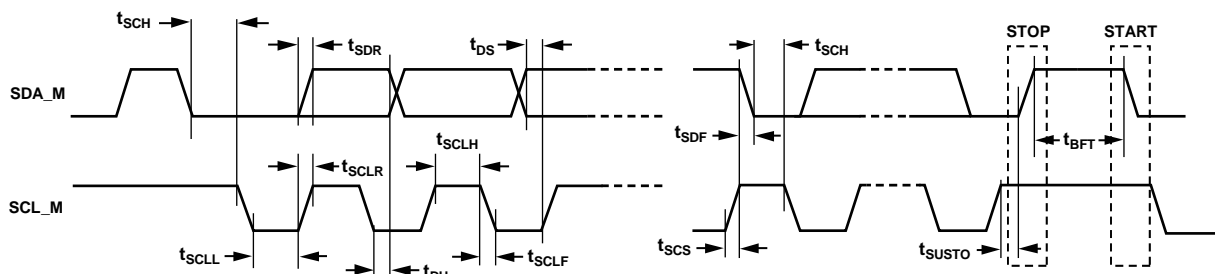

Figure 8. I<sup>2</sup>C Master Port Timing Specifications

11486-008

**SPI Interface—Slave**

T<sub>A</sub> = -40°C to +105°C, DVDD = 1.2 V ± 5%, IOVDD = 1.8 V - 10% to 3.3 V + 10%.

**Table 14.**

Parameter	Min	Max	Unit	Description
SPI SLAVE PORT				
f <sub>SCLKWRITE</sub>		22	MHz	SCLK write frequency
f <sub>SCLKREAD</sub>		22	MHz	SCLK read frequency
t <sub>SCLKPWL</sub>	6		ns	SCLK pulse width low, SCLK = 22 MHz
t <sub>SCLKPWH</sub>	21		ns	SCLK pulse width high, SCLK = 22 MHz
t <sub>SSS</sub>	1		ns	SS setup to SCLK rising edge
t <sub>SSH</sub>	2		ns	SS hold from SCLK rising edge
t <sub>SSPWH</sub>	10		ns	SS pulse width high
t <sub>SSPWL</sub>	10		ns	SS pulse width low; minimum low pulse width for SS when entering SPI mode by toggling the SS pin three times
t <sub>MOSIS</sub>	1		ns	MOSI setup to SCLK rising edge
t <sub>MOSIH</sub>	2		ns	MOSI hold from SCLK rising edge
t <sub>MISOD</sub>		39	ns	MISO valid output delay from SCLK falling edge

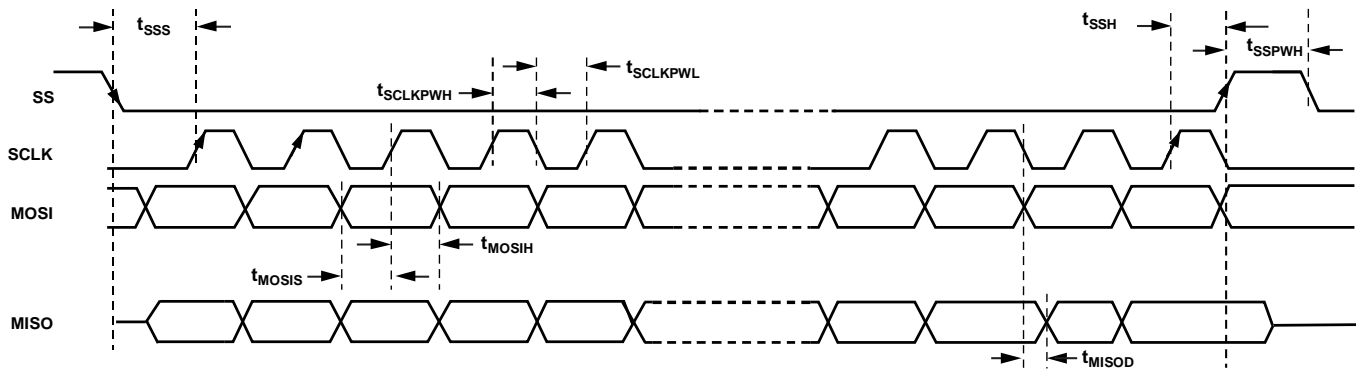

Figure 9. SPI Slave Port Timing Specifications

11486-009

**SPI Interface—Master**

$T_A = -40^{\circ}\text{C}$  to  $+105^{\circ}\text{C}$ ,  $\text{DVDD} = 1.2\text{ V} \pm 5\%$ ,  $\text{IOVDD} = 1.8\text{ V} - 10\%$  to  $3.3\text{ V} + 10\%$ .

**Table 15.**

Parameter	Min	Max	Unit	Description
<b>SPI MASTER PORT</b>				
<b>Timing Requirements</b>				
$t_{\text{SSPIDM}}$	15		ns	MISO_M data input valid to SCLK_M edge (data input setup time)
$t_{\text{HSPIDM}}$	5		ns	SCLK_M last sampling edge to data input not valid (data input hold time)
<b>Switching Characteristics</b>				
$t_{\text{SPICLK}}$	41.7		ns	SPI master clock cycle period
$f_{\text{SCLK\_M}}$		24	MHz	SPI master clock frequency
$t_{\text{SPICHM}}$	17		ns	SCLK_M high period ( $f_{\text{SCLK\_M}} = 24\text{ MHz}$ )
$t_{\text{SPICLM}}$	17		ns	SCLK_M low period ( $f_{\text{SCLK\_M}} = 24\text{ MHz}$ )
$t_{\text{DDSPIDM}}$		16.9	ns	SCLK_M edge to data out valid (data out delay time) ( $f_{\text{SCLK\_M}} = 24\text{ MHz}$ )
$t_{\text{HDSPIDM}}$	21		ns	SCLK_M edge to data out not valid (data out hold time) ( $f_{\text{SCLK\_M}} = 24\text{ MHz}$ )
$t_{\text{SDSCIM}}$	36		ns	SS_M (SPI device select) low to first SCLK_M edge ( $f_{\text{SCLK\_M}} = 24\text{ MHz}$ )
$t_{\text{HDSM}}$	95		ns	Last SCLK_M edge to SS_M high ( $f_{\text{SCLK\_M}} = 24\text{ MHz}$ )

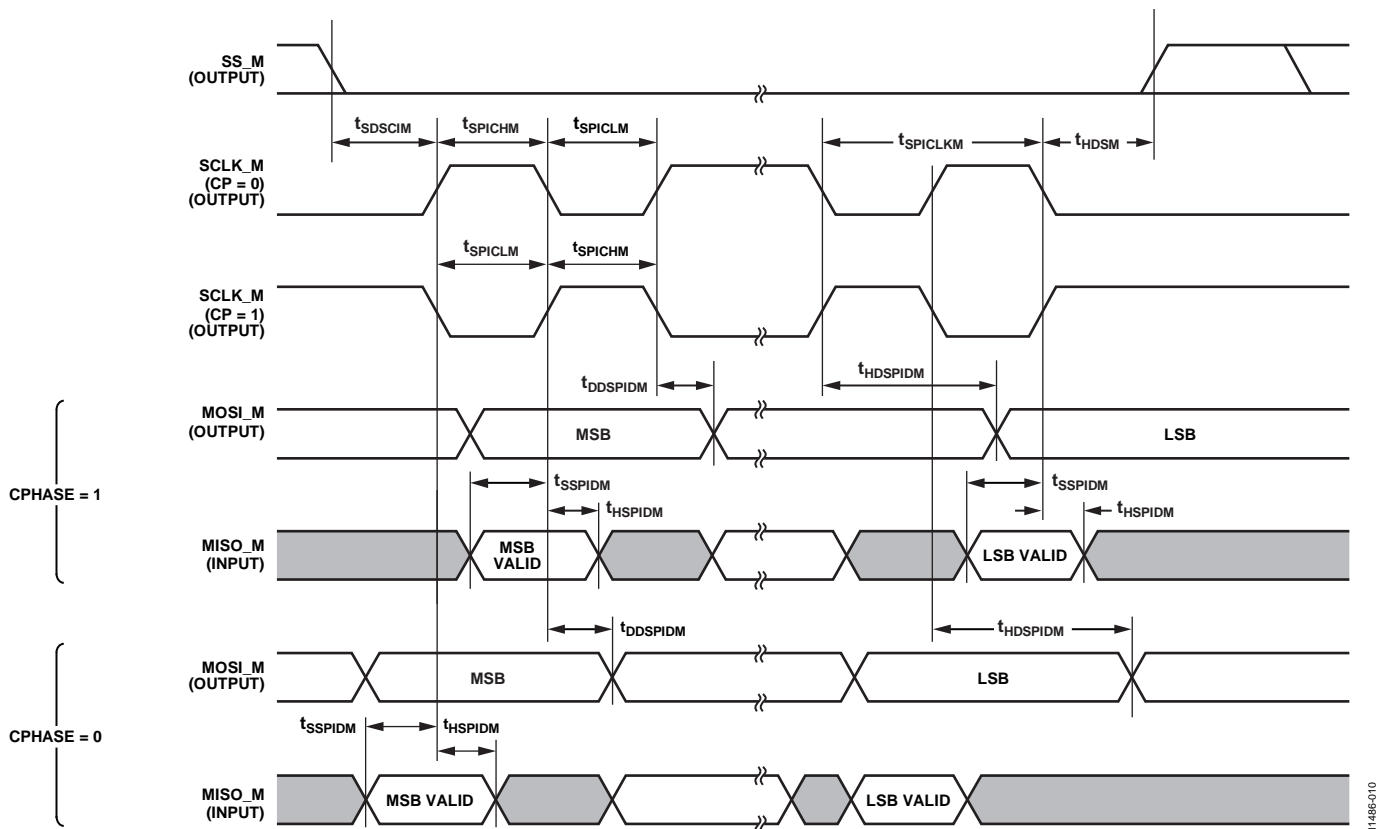

Figure 10. SPI Master Port Timing Specifications

11486-010

**PDM Inputs**

$T_A = -40^{\circ}\text{C}$  to  $+105^{\circ}\text{C}$ ,  $DVDD = 1.2\text{ V} \pm 5\%$ ,  $IOVDD = 1.8\text{ V} - 10\%$  to  $3.3\text{ V} + 10\%$ . PDM data is latched on both edges of the clock (see Figure 11).

**Table 16.**

Parameter	$t_{\text{MIN}}$	$t_{\text{MAX}}$	Unit	Description
Timing Requirements				
$t_{\text{SETUP}}$	10		ns	Data setup time
$t_{\text{HOLD}}$	5		ns	Data hold time

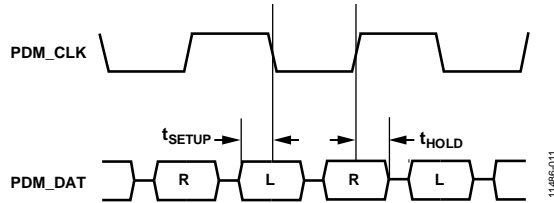

Figure 11. PDM Timing Diagram

## ABSOLUTE MAXIMUM RATINGS

Table 17.

Parameter	Rating
DVDD to Ground	0 V to 1.4 V
AVDD to Ground	0 V to 4.0 V
IOVDD to Ground	0 V to 4.0 V
PVDD to Ground	0 V to 4.0 V
Digital Inputs	DGND – 0.3 V to IOVDD + 0.3 V
Maximum Ambient Temperature Range	–40°C to +105°C
Maximum Junction Temperature	125°C
Storage Temperature Range	–65°C to +150°C
Soldering (10 sec)	300°C

Stresses at or above those listed under Absolute Maximum Ratings may cause permanent damage to the product. This is a stress rating only; functional operation of the product at these or any other conditions above those indicated in the operational section of this specification is not implied. Operation beyond the maximum operating conditions for extended periods may affect product reliability.

### THERMAL CHARACTERISTICS

$\theta_{JA}$  represents the junction-to-ambient thermal resistance;  $\theta_{JC}$  represents the junction-to-case thermal resistance. All characteristics are for a 4-layer JEDEC board. The exposed pad has 49 vias that are arranged in a 7 × 7 grid.

Table 18. Thermal Resistance

Package Type	$\theta_{JA}$	$\theta_{JC}$	Unit
72-Lead LFCSP	23.38	3.3	°C/W

### MAXIMUM POWER DISSIPATION

The characteristics listed in Table 19 show the absolute worst case power dissipation for the ADAU1452, ADAU1451, and ADAU1450. These tests were conducted at an ambient temperature of 105°C, with a completely full DSP program that executes an endless loop of the most power intensive core calculations and with all power supplies at their maximum values.

Thus, the conditions described in Table 19 are intended as a stress test only and are not representative of realistic device operation in a real-world application. In a system where the operating conditions and limits outlined in the Specifications section of this document are not exceeded, and where the device is mounted to a printed circuit board (PCB) that follows the design recommendations in the PCB Design Considerations section of this document, the values that are listed represent the total power consumption of the device. In actual applications, the power consumption of the device is far lower. Table 20, Table 21, and Table 22 show more realistic estimates for power consumption in a typical use case.

Table 19. Worst Case Maximum Power Dissipation

Parameter	Value	Unit	Test Conditions/Comments
AVDD, DVDD, PVDD During ADAU1452 Operation	960	mW	Ambient temperature = 105°C, all supplies at maximum, full DSP program using most power intensive calculations; measurement does not include IOVDD
AVDD, DVDD, PVDD During ADAU1451 Operation	960	mW	Ambient temperature = 105°C, all supplies at maximum, full DSP program using most power intensive calculations; measurement does not include IOVDD
AVDD, DVDD, PVDD During ADAU1450 Operation	960	mW	Ambient temperature = 105°C, all supplies at maximum, full DSP program using most power intensive calculations; measurement does not include IOVDD
Reset All Supplies	570	mW	Ambient temperature = 105°C, all supplies at maximum, reset mode enabled; measurement does not include IOVDD

Table 20. ADAU1452 Typical Power Dissipation Estimates

Ambient Temperature (°C)	Full Program (mW)	Typical (mW)
25	420	250
85	700	420
105	885	530

Table 21. ADAU1451 Typical Power Dissipation Estimates

Ambient Temperature (°C)	Full Program (mW)	Typical (mW)
25	420	250
85	700	420
105	885	530

Table 22. ADAU1450 Typical Power Dissipation Estimates

Ambient Temperature (°C)	Full Program (mW)	Typical (mW)
25	170	100
85	385	230
105	480	290

### ESD CAUTION



**ESD (electrostatic discharge) sensitive device.** Charged devices and circuit boards can discharge without detection. Although this product features patented or proprietary protection circuitry, damage may occur on devices subjected to high energy ESD. Therefore, proper ESD precautions should be taken to avoid performance degradation or loss of functionality.

PIN CONFIGURATION AND FUNCTION DESCRIPTIONS

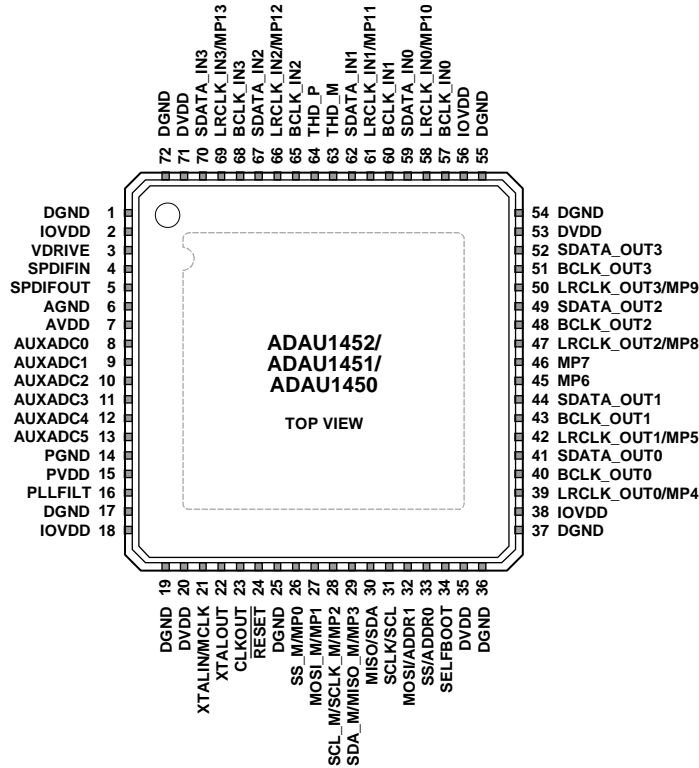

NOTES  
 1. THE EXPOSED PAD MUST BE GROUNDED BY SOLDERING IT TO A COPPER SQUARE OF EQUIVALENT SIZE ON THE PCB. IDENTICAL COPPER SQUARES MUST EXIST ON ALL LAYERS OF THE BOARD, CONNECTED BY VIAS, AND THEY MUST BE CONNECTED TO A DEDICATED COPPER GROUND LAYER WITHIN THE PCB.

11486-002

Figure 12. Pin Configuration

Table 23. Pin Function Descriptions

Pin No.	Mnemonic	Internal Pull Resistor	Description
1	DGND	None	Digital and I/O Ground Reference. Tie all DGND, AGND, and PGND pins directly together in a common ground plane.
2	IOVDD	None	Input/Output Supply, 1.8V – 10% to 3.3V + 10%. Bypass this pin with decoupling capacitors to Pin 1 (DGND).
3	VDRIVE	None	PNP Bipolar Junction Transistor-Base Drive Bias Pin for the Digital Supply Regulator. Connect VDRIVE to the base of an external PNP pass transistor (STD2805 is recommended). If an external supply is provided directly to DVDD, connect the VDRIVE pin to ground.
4	SPDIFIN	None	Input to the Integrated Sony/Philips Digital Interface Format Receiver. Disconnect this pin when not in use. This pin is internally biased to IOVDD/2. This pin is nonfunctional on the ADAU1450 and should be left disconnected.
5	SPDIFOUT	Configurable	Output from the Integrated Sony/Philips Digital Interface Format Transmitter. Disconnect this pin when not in use. This pin is internally biased to IOVDD/2. This pin is nonfunctional on the ADAU1450 and should be left disconnected.
6	AGND	None	Analog Ground Reference. Tie all DGND, AGND, and PGND pins directly together in a common ground plane.
7	AVDD	None	Analog (Auxiliary ADC) Supply. Must be 3.3V ± 10%. Bypass this pin with decoupling capacitors to Pin 6 (AGND).
8	AUXADC0	None	Auxiliary ADC Input Channel 0. This pin reads an analog input signal and uses its value in the DSP program. Disconnect this pin when not in use.
9	AUXADC1	None	Auxiliary ADC Input Channel 1. This pin reads an analog input signal and uses its value in the DSP program. Disconnect this pin when not in use.

Pin No.	Mnemonic	Internal Pull Resistor	Description
10	AUXADC2	None	Auxiliary ADC Input Channel 2. This pin reads an analog input signal and uses its value in the DSP program. Disconnect this pin when not in use.
11	AUXADC3	None	Auxiliary ADC Input Channel 3. This pin reads an analog input signal and uses its value in the DSP program. Disconnect this pin when not in use.
12	AUXADC4	None	Auxiliary ADC Input Channel 4. This pin reads an analog input signal and uses its value in the DSP program. Disconnect this pin when not in use.
13	AUXADC5	None	Auxiliary ADC Input Channel 5. This pin reads an analog input signal and uses its value in the DSP program. Disconnect this pin when not in use.
14	PGND	None	PLL Ground Reference. Tie all DGND, AGND, and PGND pins directly together in a common ground plane.
15	PVDD	None	PLL Supply. Must be $3.3\text{ V} \pm 10\%$ . Bypass this pin with decoupling capacitors to Pin 14 (PGND).
16	PLLFILT	None	PLL Filter. The voltage on the PLLFILT pin, which is internally generated, is typically between 1.65 V and 2.10 V.
17	DGND	None	Digital and I/O Ground Reference. Tie all DGND, AGND, and PGND pins directly together in a common ground plane.
18	IOVDD	None	Input/Output Supply, $1.8\text{ V} - 10\%$ to $3.3\text{ V} + 10\%$ . Bypass this pin to Pin 17 (DGND) with decoupling capacitors.
19	DGND	None	Digital and I/O Ground Reference. Tie all DGND, AGND, and PGND pins directly together in a common ground plane.
20	DVDD	None	Digital Supply. Must be $1.2\text{ V} \pm 5\%$ . This pin can be supplied externally or by using the internal regulator and external pass transistor. Bypass this pin to Pin 19 (DGND) with decoupling capacitors.
21	XTALIN/MCLK	None	Crystal Oscillator Input (XTALIN)/Master Clock Input to the PLL (MCLK). This pin can be supplied directly or generated by driving a crystal with the internal crystal oscillator via Pin 22 (XTALOUT). If a crystal is used, refer to the circuit shown in Figure 15.
22	XTALOUT	None	Crystal Oscillator Output for Driving an External Crystal. If a crystal is used, refer to the circuit shown in Figure 15. Disconnect this pin when not in use.
23	CLKOUT	Configurable	Master Clock Output. This pin drives a master clock signal to other ICs in the system. CLKOUT can be configured to output a clock signal with a frequency of $1\times$ , $2\times$ , $4\times$ , or $8\times$ the frequency of the divided clock signal being input to the PLL. Disconnect this pin when not in use.
24	RESET	Pull-down	Active Low Reset Input. A reset is triggered on a high-to-low edge and exited on a low-to-high edge. A reset event sets all RAMs and registers to their default values.
25	DGND	None	Digital and I/O Ground Reference. Tie all DGND, AGND, and PGND pins directly together in a common ground plane.
26	SS_M/MP0	Pull-up; nominally 250 k $\Omega$ ; can be disabled by a write to control register	SPI Master/Slave Select Port (SS_M)/Multipurpose, General-Purpose Input/Output (MP0). When in SPI master mode, this pin acts as the slave select signal to slave devices on the SPI bus. The pin must go low at the beginning of a master SPI transaction and high at the end of a transaction. This pin has an internal pull-up resistor that is nominally 250 k $\Omega$ . When the SELFBOOT pin is held high and the RESET pin has a transition from low to high, Pin 26 sets the communications protocol for self boot operation. If this pin is left floating, the SPI communications protocol is used for self boot operation. If this pin has a 10 k $\Omega$ pull-down resistor to GND, the I <sup>2</sup> C communications protocol is used for self boot operation. When self boot operation is not used and this pin is not needed as a general-purpose input or output, leave it disconnected.
27	MOSI_M/MP1	Pull-up; can be disabled by a write to control register	SPI Master Data Output Port (MOSI_M)/Multipurpose, General-Purpose Input/Output (MP1). When in SPI master mode, this pin sends data from the SPI master port to slave devices on the SPI bus. Disconnect this pin when not in use.
28	SCL_M/ SCLK_M/MP2	Pull-up; can be disabled by a write to control register	I <sup>2</sup> C Master Serial Clock Port (SCL_M)/SPI Master Mode Serial Clock (SCLK_M)/Multipurpose, General-Purpose Input/Output (MP2). When in I <sup>2</sup> C master mode, this pin functions as an open collector output and drives a serial clock to slave devices on the I <sup>2</sup> C bus; use a 2.0 k $\Omega$ pull-up resistor to IOVDD on the line connected to this pin. When in SPI master mode, this pin drives the clock signal to slave devices on the SPI bus. Disconnect this pin when not in use.
29	SDA_M/ MISO_M/MP3	Pull-up; can be disabled by a write to control register	I <sup>2</sup> C Master Port Serial Data (SDA_M)/SPI Master Mode Data Input (MISO_M)/Multipurpose, General-Purpose Input/Output (MP3). When in I <sup>2</sup> C master mode, this pin functions as a bi-directional open collector data line between the I <sup>2</sup> C master port and slave devices on the I <sup>2</sup> C bus; use a 2.0 k $\Omega$ pull-up resistor to IOVDD on the line connected to this pin. When in SPI master mode, this pin receives data from slave devices on the SPI bus. Disconnect this pin when not in use.

Pin No.	Mnemonic	Internal Pull Resistor	Description
30	MISO/SDA	Pull-up; can be disabled by a write to control register	SPI Slave Data Output Port (MISO)/I <sup>2</sup> C Slave Serial Data Port (SDA). In SPI slave mode, this pin outputs data to the master device on the SPI bus. In I <sup>2</sup> C slave mode, this pin functions as a bi-directional open collector data line between the I <sup>2</sup> C slave port and the master device on the I <sup>2</sup> C bus; use a 2.0 kΩ pull-up resistor to IOVDD on the line connected to this pin. When this pin is not in use, connect it to IOVDD with a 10.0 kΩ pull-up resistor.
31	SCLK/SCL	Pull-up; can be disabled by a write to control register	SPI Slave Port Serial Clock (SCLK)/I <sup>2</sup> C Slave Port Serial Clock (SCL). In SPI slave mode, this pin receives the serial clock signal from the master device on the SPI bus. In I <sup>2</sup> C slave mode, this pin receives the serial clock signal from the master device on the I <sup>2</sup> C bus; use a 2.0 kΩ pull-up resistor to IOVDD on the line connected to this pin. When this pin is not in use, connect it to IOVDD with a 10.0 kΩ pull-up resistor.
32	MOSI/ADDR1	Pull-up; can be disabled by a write to control register	SPI Slave Port Data Input (MOSI)/I <sup>2</sup> C Slave Port Address MSB (ADDR1). In SPI slave mode, this pin receives a data signal from the master device on the SPI bus. In I <sup>2</sup> C slave mode, this pin acts as an input and sets the chip address of the I <sup>2</sup> C slave port, in conjunction with Pin 33 (SS/ADDR0).
33	SS/ADDR0	Pull-up, nominally 250 kΩ; can be disabled by a write to control register	SPI Slave Port Slave Select (SS)/I <sup>2</sup> C Slave Port Address LSB (ADDR0). In SPI slave mode, this pin receives the slave select signal from the master device on the SPI bus. In I <sup>2</sup> C slave mode, this pin acts as an input and sets the chip address of the I <sup>2</sup> C slave port in conjunction with Pin 32 (MOSI/ADDR1).
34	SELFBOOT	Pull-up	Self Boot Select. This pin allows the device to perform a self boot, in which it loads its RAM and register settings from an external EEPROM. Connecting Pin 34 to logic high (IOVDD) initiates a self boot operation the next time there is a rising edge on Pin 24 (RESET). When this pin is connected to ground, no self boot operation is initiated. This pin can be connected to IOVDD or to ground either directly or pulled up or down with a 1.0 kΩ or larger resistor.
35	DVDD	None	Digital Supply. Must be 1.2 V ± 5%. This pin can be supplied externally or by using the internal regulator and external pass transistor. Bypass this pin to Pin 36 (DGND) with decoupling capacitors.
36	DGND	None	Digital and I/O Ground Reference. Tie all DGND, AGND, and PGND pins directly together in a common ground plane.
37	DGND	None	Digital and I/O Ground Reference. Tie all DGND, AGND, and PGND pins directly together in a common ground plane.
38	IOVDD	None	Input/Output Supply, 1.8 V – 10% to 3.3 V + 10%. Bypass this pin with decoupling capacitors to Pin 37 (DGND).
39	LRCLK_OUT0/ MP4	Configurable	Frame Clock, Serial Output Port 0 (LRCLK_OUT0)/Multipurpose, General-Purpose Input/Output (MP4). This pin is bidirectional, with the direction depending on whether Serial Output Port 0 is a master or slave. Disconnect this pin when not in use.
40	BCLK_OUT0	Configurable	Bit Clock, Serial Output Port 0. This pin is bidirectional, with the direction depending on whether the Serial Output Port 0 is a master or slave. Disconnect this pin when not in use.
41	SDATA_OUT0	Configurable	Serial Data Output Port 0 (Channel 0 to Channel 15). Capable of 2-channel, 4-channel, 8-channel, and 16-channel modes. Disconnect this pin when not in use.
42	LRCLK_OUT1/ MP5	Configurable	Frame Clock, Serial Output Port 1 (LRCLK_OUT1)/Multipurpose, General-Purpose Input/Output (MP5). This pin is bidirectional, with the direction depending on whether Serial Output Port 1 is a master or slave. Disconnect this pin when not in use.
43	BCLK_OUT1	Configurable	Bit Clock, Serial Output Port 1. This pin is bidirectional, with the direction depending on whether Output Serial Port 1 is a master or slave. Disconnect this pin when not in use.
44	SDATA_OUT1	Configurable	Serial Data Output Port 1 (Channel 16 to Channel 31). Capable of 2-channel, 4-channel, 8-channel, and 16-channel modes. Disconnect this pin when not in use.
45	MP6	Configurable	Multipurpose, General-Purpose Input/Output 6. Disconnect this pin when not in use.
46	MP7	Configurable	Multipurpose, General-Purpose Input/Output 7. Disconnect this pin when not in use.
47	LRCLK_OUT2/ MP8	Configurable	Frame Clock, Serial Output Port 2 (LRCLK_OUT2)/Multipurpose, General-Purpose Input/Output (MP8). This pin is bidirectional, with the direction depending on whether Serial Output Port 2 is a master or slave. Disconnect this pin when not in use.
48	BCLK_OUT2	Configurable	Bit Clock, Serial Output Port 2. This pin is bidirectional, with the direction depending on whether Serial Output Port 2 is a master or slave. Disconnect this pin when not in use.
49	SDATA_OUT2	Configurable	Serial Data Output Port 2 (Channel 32 to Channel 39). Capable of 2-channel, 4-channel, 8-channel, or flexible TDM mode. Disconnect this pin when not in use.
50	LRCLK_OUT3/ MP9	Configurable	Frame Clock, Serial Output Port 3 (LRCLK_OUT3)/Multipurpose, General-Purpose Input/Output (MP9). This pin is bidirectional, with the direction depending on whether Serial Output Port 3 is a master or slave. Disconnect this pin when not in use.



Pin No.	Mnemonic	Internal Pull Resistor	Description
51	BCLK_OUT3	Configurable	Bit Clock, Serial Output Port 3. This pin is bidirectional, with the direction depending on whether Serial Output Port 3 is a master or slave. Disconnect this pin when not in use.
52	SDATA_OUT3	Configurable	Serial Data Output Port 3 (Channel 40 to Channel 47). Capable of 2-channel, 4-channel, 8-channel, and flexible TDM modes. Disconnect this pin when not in use.
53	DVDD	None	Digital Supply. Must be $1.2\text{ V} \pm 5\%$ . This pin can be supplied externally or by using the internal regulator and external pass transistor. Bypass Pin 53 with decoupling capacitors to Pin 54 (DGND).
54	DGND	None	Digital and I/O Ground Reference. Tie all DGND, AGND, and PGND pins directly together in a common ground plane.
55	DGND	None	Digital and I/O Ground Reference. Tie all DGND, AGND, and PGND pins directly together in a common ground plane.
56	IOVDD	None	Input/Output Supply, $1.8\text{ V} - 10\%$ to $3.3\text{ V} + 10\%$ . Bypass this pin with decoupling capacitors to Pin 55 (DGND).
57	BCLK_IN0	Configurable	Bit Clock, Serial Input Port 0. This pin is bidirectional, with the direction depending on whether Serial Input Port 0 is a master or slave. Disconnect this pin when not in use.
58	LRCLK_IN0/ MP10	Configurable	Frame Clock, Serial Input Port 0 (LRCLK_IN0)/Multipurpose, General-Purpose Input/Output (MP10). This pin is bidirectional, with the direction depending on whether Serial Input Port 0 is a master or slave. Disconnect this pin when not in use.
59	SDATA_IN0	Configurable	Serial Data Input Port 0 (Channel 0 to Channel 15). Capable of 2-channel, 4-channel, 8-channel, or 16-channel mode. Disconnect this pin when not in use.
60	BCLK_IN1	Configurable	Bit Clock, Serial Input Port 1. This pin is bidirectional, with the direction depending on whether the Serial Input Port 1 is a master or slave. Disconnect this pin when not in use.
61	LRCLK_IN1/ MP11	Configurable	Frame Clock, Serial Input Port 1 (LRCLK_IN1)/Multipurpose, General-Purpose Input/Output (MP11). This pin is bidirectional, with the direction depending on whether the Serial Input Port 1 is a master or slave. Disconnect this pin when not in use.
62	SDATA_IN1	Configurable	Serial Data Input Port 1 (Channels 16 to Channel 31). Capable of 2-channel, 4-channel, 8-channel, or 16-channel mode. Disconnect this pin when not in use.
63	THD_M	None	Thermal Diode Negative (-) Input. Connect this pin to the D- pin of an external temperature sensor IC. Disconnect this pin when not in use.
64	THD_P	None	Thermal Diode Positive (+) Input. Connect this pin to the D+ pin of an external temperature sensor IC. Disconnect this pin when not in use.
65	BCLK_IN2	Configurable	Bit Clock, Serial Input Port 2. This pin is bidirectional, with the direction depending on whether the Serial Input Port 2 is a master or slave. Disconnect this pin when not in use.
66	LRCLK_IN2/ MP12	Configurable	Frame Clock, Input Serial Port 2 (LRCLK_IN2)/Multipurpose, General-Purpose Input/Output (MP12). This pin is bidirectional, with the direction depending on whether Serial Input Port 2 is a master or slave. Disconnect this pin when not in use.
67	SDATA_IN2	Configurable	Serial Data Input Port 2 (Channel 32 to Channel 39). Capable of 2-channel, 4-channel, 8-channel, or flexible TDM mode. Disconnect this pin when not in use.
68	BCLK_IN3	Configurable	Bit Clock, Input Serial Port 3. This pin is bidirectional, with the direction depending on whether Input Serial Port 3 is a master or slave. Disconnect this pin when not in use.
69	LRCLK_IN3/ MP13	Configurable	Frame Clock, Serial Input Port 3 (LRCLK_IN3)/Multipurpose, General-Purpose Input/Output (MP13). This pin is bidirectional, with the direction depending on whether Serial Input Port 3 is a master or slave. Disconnect this pin when not in use.
70	SDATA_IN3	Configurable	Serial Data Input Port 3 (Channel 40 to Channel 47). Capable of 2-channel, 4-channel, 8-channel, or flexible TDM mode. Disconnect this pin when not in use.
71	DVDD	None	Digital Supply. Must be $1.2\text{ V} \pm 5\%$ . This pin can be supplied externally or by using the internal regulator and external pass transistor. Bypass with decoupling capacitors to Pin 72 (DGND).
72	DGND	None	Digital and I/O Ground Reference. Tie all DGND, AGND, and PGND pins directly together in a common ground plane.
EP	Exposed Pad	None	The exposed pad must be grounded by soldering it to a copper square of equivalent size on the PCB. Identical copper squares must exist on all layers of the board, connected by vias, and they must be connected to a dedicated copper ground layer within the PCB. For more detailed information, see Figure 84 and Figure 85.

**THEORY OF OPERATION**  
**SYSTEM BLOCK DIAGRAM**

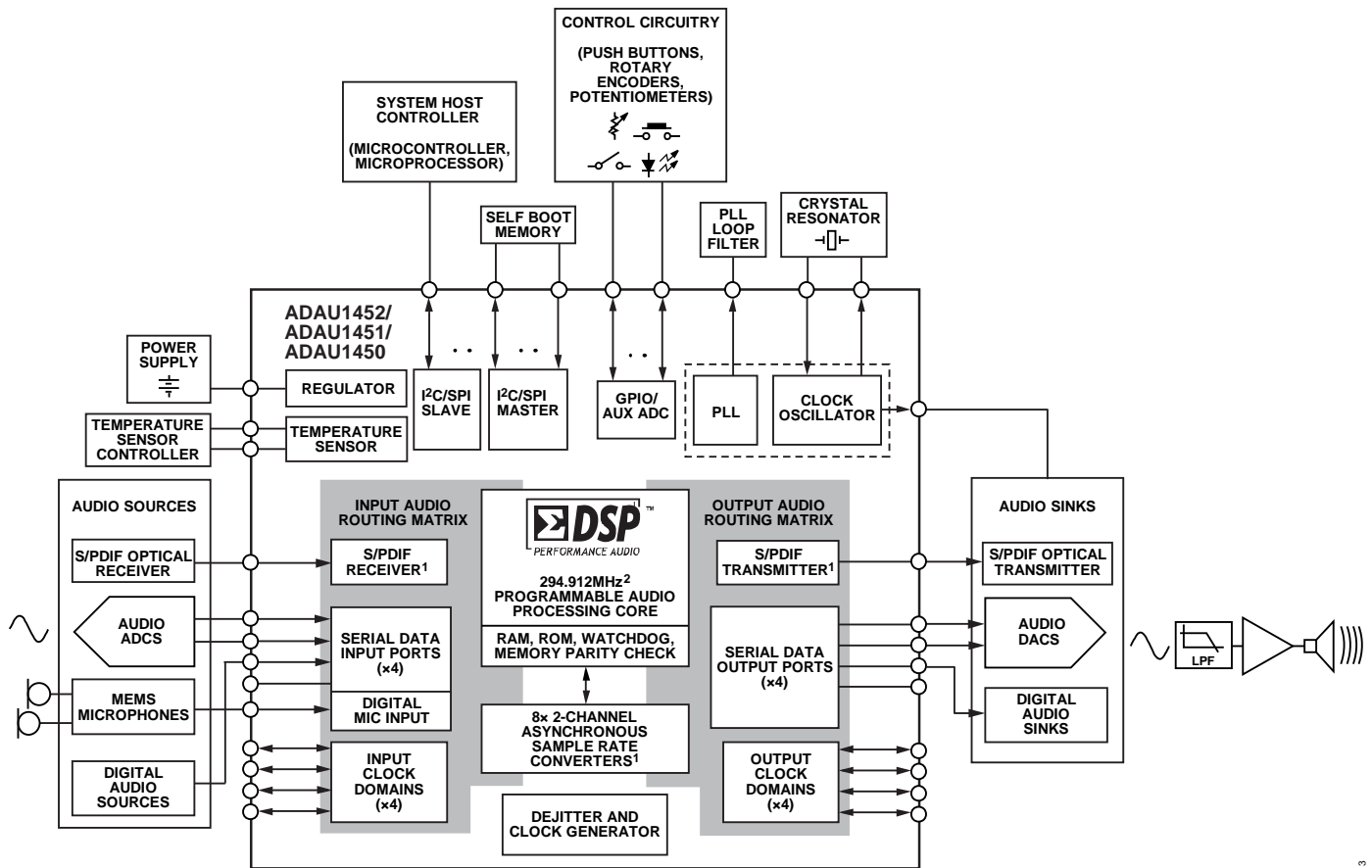

<sup>1</sup>THE S/PDIF RECEIVER, THE S/PDIF TRANSMITTER, AND THE ASYNCHRONOUS SAMPLE RATE CONVERTERS ARE NOT PRESENT ON THE ADAU1450.  
<sup>2</sup>THE ADAU1450 HAS A 147.456MHz PROGRAMMABLE AUDIO PROCESSING CORE.

Figure 13. System Block Diagram with Example Connections to External Components

**OVERVIEW**

The ADAU1452/ADAU1451/ADAU1450 are enhanced audio processors with 48 channels of input and output. They include options for the hardware routing of audio signals between the various inputs, outputs, SigmaDSP core, and integrated sample rate converters. The SigmaDSP core features full 32-bit processing (that is, 64-bit processing in double precision mode) with an 80-bit arithmetic logic unit (ALU). By using a quadruple multiply accumulator (MAC) data path, the ADAU1452/ADAU1451 can execute more than 1.2 billion MAC operations per second, which allows for processing power that far exceeds the predecessors in the SigmaDSP family of products. The powerful DSP core can process over 3000 double precision biquad filters or 24,000 FIR filter taps per sample at the standard 48 kHz audio sampling rate. The ADAU1450 features half the processing power of the ADAU1452/ADAU1451. Other features, including synchronous parameter loading for ensuring filter stability and 100% code efficiency with the SigmaStudio tools, reduce complexity in audio system development. The SigmaStudio library of audio processing algorithms allows system designers to compensate for real-world

limitations of speakers, amplifiers, and listening environments, through speaker equalization, multiband compression, limiting, and third party branded algorithms.

The input audio routing matrix and output audio routing matrix allow the user to multiplex inputs from multiple sources that are running at various sample rates to or from the SigmaDSP core, and then to pass them on to the desired hardware outputs. This drastically reduces the complexity of signal routing and clocking issues in the audio system. The audio subsystem includes up to eight stereo asynchronous sample rate converters (ASRCs), depending on the device model; Sony/Philips Digital Interconnect Format (S/PDIF) input and output (available on the ADAU1452/ADAU1451); and serial (I<sup>2</sup>S) and time division multiplexing (TDM) I/Os. Any of these inputs can be routed to the SigmaDSP core or to any of the ASRCs (except on the ADAU1450, which does not have ASRCs). Similarly, the output signals can be taken from the SigmaDSP core, any of the ASRC outputs, the serial inputs, the PDM microphones, or the S/PDIF receiver. This routing scheme, which can be modified at any time using control registers, allows for maximum system flexibility without requiring hardware design changes.

Two serial input ports and two serial output ports can operate as pairs in a special flexible TDM mode, allowing the user to independently assign byte specific locations to audio streams at varying bit depths. This mode ensures compatibility with codecs that use similar flexible TDM streams.

The DSP core is optimized for audio processing, and it can process audio at sample rates of up to 192 kHz. The program and parameter/data RAMs can be loaded with a custom audio processing signal flow built with the SigmaStudio graphical programming software from Analog Devices, Inc. The values that are stored in the parameter RAM can control individual signal processing blocks, such as IIR and FIR equalization filters, dynamics processors, audio delays, and mixer levels. A software safeload feature allows for transparent parameter updates and prevents clicks on the output signals.

Reliability features, such as memory parity checking and a program counter watchdog, help ensure that the system can detect and recover from any errors related to memory corruption.

On the [ADAU1452/ADAU1451](#), S/PDIF signals can be routed through an ASRC for processing in the DSP or can be sent directly to output on the multipurpose pins (MPx) for recovery of the embedded audio signal. Other components of the embedded signal, including status and user bits, are not lost and can be output on the MPx pins as well. The user can also independently program the nonaudio data that is embedded in the output signal of the S/PDIF transmitter.

The 14 MPx pins are available for providing a simple user interface without the need for an external microcontroller. These multipurpose pins are available to input external control signals and output flags or controls to other devices in the system. As inputs, the MPx pins can be connected to push buttons, switches, rotary encoders, or other external control circuitry to control the internal signal processing program. When configured as outputs, these pins can be used to drive LEDs (with a buffer), output flags to a microcontroller, control other ICs, or connect to other external circuitry in an application. In addition to the multipurpose pins, six dedicated input pins (AUXADC5 to AUXADC0) are connected to an auxiliary ADC for use with analog controls such as potentiometers or system voltages.

The SigmaStudio software programs and controls the device through the control port. In addition to designing and tuning a signal flow, the software can configure all of the DSP registers in real time and download a new program and parameters into the external self boot EEPROM. The easy to use SigmaStudio graphical interface allows anyone with audio processing knowledge to easily design a DSP signal flow and port it to a target application without the need for writing line level code. At the same time, the software provides enough flexibility and programmability to allow an experienced DSP programmer to have in-depth control of the design.

In SigmaStudio, the user can add signal processing cells from the library by dragging and dropping cells, connect them together in a flow, compile the design, and load the program and parameter files into memory through the control port. The complicated tasks of linking, compiling, and downloading the project are all handled automatically by the software.

Signal processing algorithms that are available in the provided libraries include the following:

- Single and double precision biquad filter
- Mono and multichannel dynamics processors with peak or rms detection
- Mixer and splitter
- Tone and noise generator
- Fixed and variable gain
- Loudness
- Delay
- Stereo enhancement
- Dynamic bass boost
- Noise and tone source
- Level detector
- MPx pin control and conditioning
- FFT and frequency domain processing algorithms

Analog Devices continuously develops new processing algorithms and provides proprietary and third party algorithms for applications such as matrix decoding, bass enhancement, and surround virtualizers.

Several power-saving mechanisms are available, including programmable pad strength for digital I/O pins and the ability to power down unused subsystems.

Fabricated on a single monolithic integrated circuit for operation over the  $-40^{\circ}\text{C}$  to  $+105^{\circ}\text{C}$  temperature range, the device is housed in a 72-lead LFCSP package with an exposed pad to assist in heat dissipation.

The device can be controlled in one of two operational modes, as follows:

- The settings of the chip can be loaded and dynamically updated through the SPI/I<sup>2</sup>C port.
- The DSP can self boot from an external EEPROM in a system with no microcontroller.

The [ADAU1452WBCPZ](#), [ADAU1452WBCPZ-RL](#), [ADAU1451WBCPZ](#), [ADAU1451WBCPZ-RL](#), [ADAU1450WBCPZ](#), and [ADAU1450WBCPZ-RL](#) models are qualified for use in automotive applications.

## INITIALIZATION

### Power-Up Sequence

The first step in the initialization sequence is to power up the device. First, apply voltage to the power pins. All power pins can be supplied simultaneously. If the power pins are not supplied simultaneously, then supply IOVDD first because the internal ESD protection diodes are referenced to the IOVDD voltage. AVDD, DVDD, and PVDD can be supplied at the same time as IOVDD or after, but they must not be supplied prior to IOVDD. The order in which AVDD, DVDD, and PVDD are supplied does not matter.

When the internal regulator is not used and DVDD is directly supplied, no special sequence is required when providing the proper voltages to AVDD, DVDD, and PVDD.

When the internal regulator is used, DVDD is generated by the regulator, in combination with an external pass transistor, after AVDD, IOVDD, and PVDD are supplied. See the Power Supplies section for more information.

Each power supply domain has its own power-on reset (POR) circuits (also known as power OK circuits) to ensure that the level shifters attached to each power domain can be initialized properly. AVDD and PVDD must reach their nominal level before the auxiliary ADC and PLL can be used, respectively.

However, the AVDD and PVDD supplies have no role in the rest of the power-up sequence. After AVDD power reaches its nominal threshold, the regulator becomes active and begins to charge up the DVDD supply. The DVDD also has a POR circuit to ensure that the level shifters initialize during power-up.

The POR signals are combined into three global level shifter resets that properly initialize the signal crossings between each separate power domain and DVDD.

The digital circuits remain in reset until the IOVDD to DVDD level shifter reset is released. At that point, the digital circuits exit reset.

When a crystal is in use, the crystal oscillator circuit must provide a stable master clock to the XTALIN/MCLK pin by the time the PVDD supply reaches its nominal level. The XTALIN/MCLK pin is restricted from passing into the PLL circuitry until the DVDD POR signal becomes active and the PVDD to DVDD level shifter is initialized.

When all four POR circuits signal that the power-on conditions are met, a reset synchronizer circuit releases the internal digital circuitry from reset, provided the following conditions are met:

- A valid MCLK signal is provided to the digital circuitry and the PLL.
- The RESET pin is high.

When the internal digital circuitry becomes active, the DSP core runs eight lines of initialization code stored in ROM, requiring eight cycles of the MCLK signal. For a 12.288 MHz MCLK input, this process takes 650 ns.

After the ROM program completes its execution, the PLL is ready to be configured using register writes to Register 0xF000 (PLL\_CTRL0), Register 0xF001 (PLL\_CTRL1), Register 0xF002 (PLL\_CLK\_SRC), and Register 0xF003 (PLL\_ENABLE).

When the PLL is configured and enabled, the PLL starts to lock to the incoming master clock signal. The absolute maximum PLL lock time is  $32 \times 1024 = 32,768$  clock cycles on the clock signal (after the input prescaler), which is fed to the input of the PLL. In a standard 48 kHz use case, the PLL input clock frequency after the prescaler is 3.072 MHz; therefore, the maximum PLL lock time is 10.666 ms.

Typically, the PLL locks much faster than 10.666 ms. In most systems, the PLL locks within about 3.5 ms. The PLL\_LOCK register (Address 0xF004) can be polled via the control port until Bit 0 (PLL\_LOCK) goes high, signifying that the PLL lock has completed successfully.

While the PLL is attempting to lock to the input clock, the I<sup>2</sup>C slave and SPI slave control ports are inactive; therefore, no other registers are accessible over the control port. While the PLL is attempting to lock, all attempts to write to the control port fail.

Figure 14 shows an example power-up sequence with all relevant signals labeled. If possible, apply the required voltage to all four power supply domains (IOVDD, AVDD, PVDD, and DVDD) simultaneously. If the power supplies are separate, IOVDD, which is the reference for the ESD protection diodes that are situated

inside the input and output pins, must be applied first to avoid stressing these diodes. PVDD, AVDD, and DVDD can then be supplied in any order (see the System Initialization Sequence section for more information). Note that the gray areas in this figure represent clock signals.

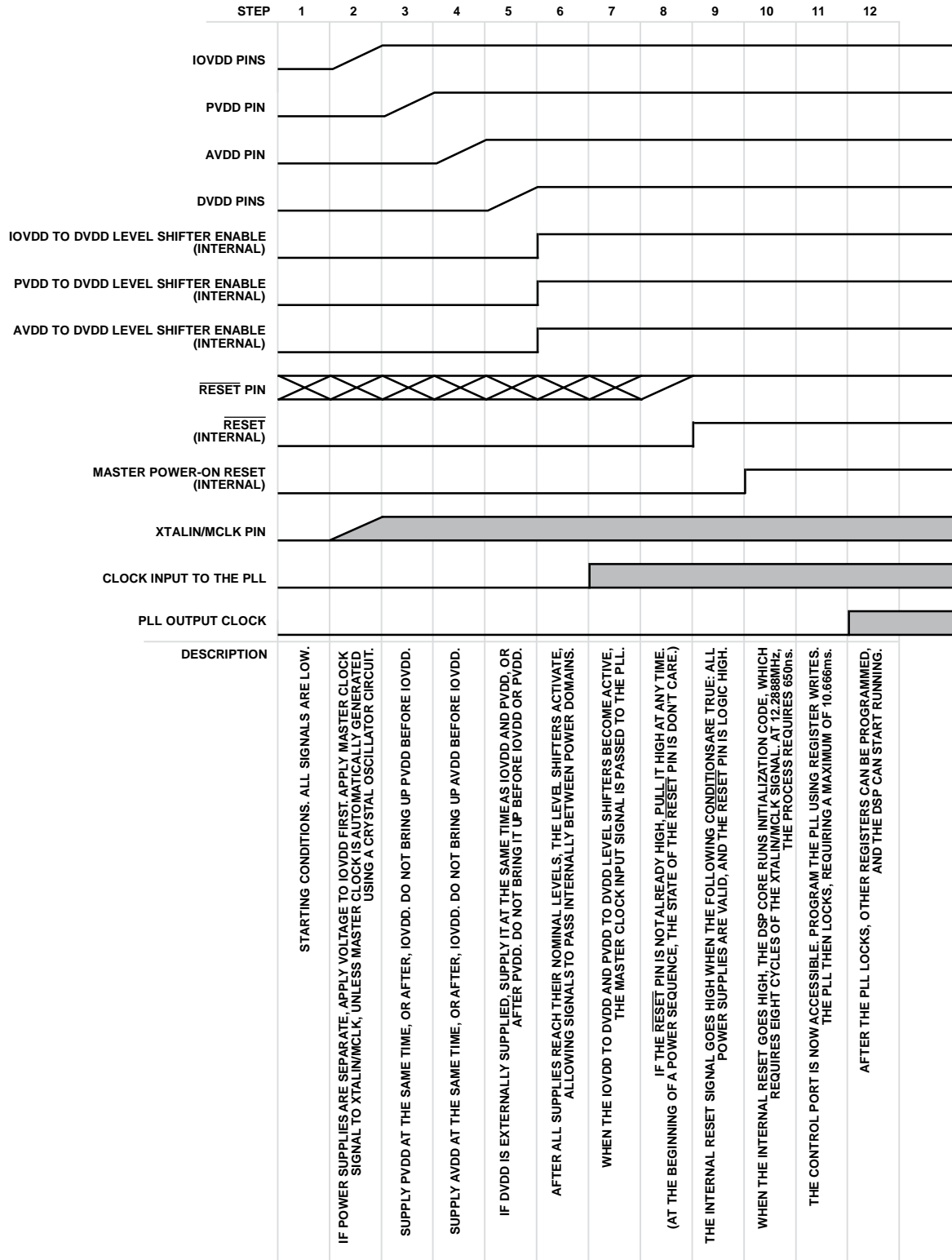

Figure 14. Power Sequencing and POR Timing Diagram for a System with Separate Power Supplies

**System Initialization Sequence**

Before the IC can process the audio in the DSP, the following initialization sequence must be completed.

1. If possible, apply the required voltage to all four power supply domains (IOVDD, AVDD, PVDD, and DVDD) simultaneously. If simultaneous application is not possible, supply IOVDD first to prevent damage or reduced operating lifetime. If using the on-board regulator, AVDD and PVDD can be supplied in any order, and DVDD is then generated automatically. If not using the on-board regulator, AVDD, PVDD, and DVDD can be supplied in any order following IOVDD.
2. Start providing a master clock signal to the XTALIN/MCLK pin, or, if using the crystal oscillator, let the crystal oscillator start generating a master clock signal. The master clock signal must be valid when the DVDD supply stabilizes.
3. If the SELFB00T pin is pulled high, a self boot sequence initiates on the master control port. Wait until the self boot operation is complete.
4. If SPI slave control mode is desired, toggle the SS/ADDR0 pin three times. Ensure that each toggle lasts at least the duration of one cycle of the master clock being input to the

- XTALIN/MCLK pin. When the SS/ADDR0 line rises for the third time, the slave control port is then in SPI mode.
5. Execute the register and memory write sequence that is required to configure the device in the proper operating mode.

Table 24 contains an example series of register writes used to configure the system at startup. The contents of the data column may vary depending on the system configuration. The configuration that is listed in Table 24 represents the default initialization sequence for project files generated in SigmaStudio.

**Recommended Program/Parameter Loading Procedure**

When writing large amounts of data to the program or parameter RAM in direct write mode (such as when downloading the initial contents of the RAMs from an external memory), use the hibernate register (Address 0xF400) to disable the processor core, thus preventing unpleasant noises from appearing at the audio output. When small amounts of data are transmitted during real-time operation of the DSP (such as when updating individual parameters), the software safeload mechanism can be used (see the Software Safeload section).

**Table 24. Example System Initialization Register Write Sequence<sup>1</sup>**

Address	Data	Register/Memory	Description
N/A	N/A	N/A	Toggle SS/ADDR0 three times to enable SPI slave mode, if necessary.
0xF890	0x00, 0x00	SOFT_RESET	Enter soft reset.
0xF890	0x00, 0x01	SOFT_RESET	Exit soft reset.
0xF000	0x00, 0x60	PLL_CTRL0	Set feedback divider to 96 (this is the default power-on setting).
0xF001	0x00, 0x02	PLL_CTRL1	Set PLL input clock divider to 4.
0xF002	0x00, 0x01	PLL_CLK_SRC	Set clock source to PLL clock.
0xF005	0x00, 0x05	MCLK_OUT	Enable MCLK output (12.288 MHz).
0xF003	0x00, 0x01	PLL_ENABLE	Enable PLL.
N/A	N/A	N/A	Wait for PLL lock (see the Power-Up Sequence section); the maximum PLL lock time is 10.666 ms.
0xF050	0x4F, 0xFF	POWER_ENABLE0	Enable power for all major systems except Clock Generator 3 (Clock Generator 3 is rarely used in most systems).
0xF051	0x00, 0x00	POWER_ENABLE1	Disable power for subsystems like PDM microphones, S/PDIF, and the ADC if they are not being used in the system.
0xC000	Data generated by SigmaStudio	Program RAM data	Download the entire program RAM contents using a block write (data provided by SigmaStudio compiler).
0x0000	Data generated by SigmaStudio	DM0 RAM data	Download Data Memory DM0 using a block write (data provided by SigmaStudio compiler).
0x6000	Data generated by SigmaStudio	DM1 RAM data	Download Data Memory DM1 using a block write (data provided by SigmaStudio compiler); the start address of DM1 may vary, depending on the SigmaStudio compilation.
0xF404	0x00, 0x00	START_ADDRESS	Set program start address as defined by the SigmaStudio compiler.
0xF401	0x00, 0x02	START_PULSE	Set DSP core start pulse to internally generated pulse.
N/A	N/A	N/A	Configure any other registers that require nondefault values.
0xF402	0x00, 0x00	START_CORE	Stop the core.
0xF402	0x00, 0x01	START_CORE	Start the core.
N/A	N/A	N/A	Wait 50 μs for initialization program to execute.

<sup>1</sup> N/A means not applicable.

## MASTER CLOCK, PLL, AND CLOCK GENERATORS

### Clocking Overview

To externally supply the master clock, connect the clock source directly to the XTALIN/MCLK pin. Alternatively, use the internal clock oscillator to drive an external crystal.

### Using the Oscillator

The ADAU1452/ADAU1451/ADAU1450 can use an on-board oscillator to generate its master clock. However, to complete the oscillator circuit, an external crystal must be attached. The on-board oscillator is designed to work with a crystal that is tuned to resonate at a frequency of the nominal system clock divided by 24. For a normal system, where the nominal system clock is 294.912 MHz, this frequency is 12.288 MHz.

The fundamental frequency of the crystal can be up to 30 MHz. Practically speaking, in most systems the fundamental frequency of the crystal should be in a range from 3.072 MHz to 24.576 MHz.

For the external crystal in the circuit, use an AT-cut parallel resonance device operating at its fundamental frequency. Do not use ceramic resonators, because of their poor jitter performance. Quartz crystals are ideal for audio applications. Figure 15 shows the crystal oscillator circuit that is recommended for proper operation.

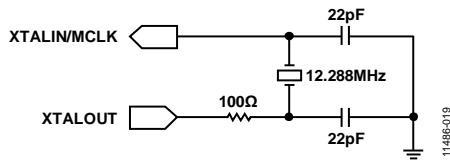

Figure 15. Crystal Resonator Circuit

The 100 Ω damping resistor on XTALOUT provides the oscillator with a voltage swing of approximately 3.1 V at the XTALIN/MCLK pin. The optimal crystal shunt capacitance is 7 pF. Its optimal load capacitance, specified by the manufacturer, should be about 20 pF although the circuit supports values of up to 25 pF. Ensure that the equivalent series resistance is as small as possible. Calculate the necessary values of the two load capacitors in the circuit from the crystal load capacitance, using the following equation:

$$C_L = \frac{C1 \times C2}{C1 + C2} + C_{STRAY}$$

where:

$C1$  and  $C2$  are the load capacitors.

$C_{STRAY}$  is the stray capacitance in the circuit.  $C_{STRAY}$  is usually assumed to be approximately 2 pF to 5 pF, but it varies depending on the PCB design.

Short trace lengths in the oscillator circuit decrease stray capacitance, thereby increasing the loop gain of the circuit and helping to avoid crystal start-up problems. Therefore, place the crystal as near to the XTALOUT pin as possible, and on the same side of the PCB.

On the EVAL-ADAU1452MINIZ evaluation board, the  $C1$  and  $C2$  load capacitors are 22 pF.

Do not use XTALOUT to directly drive the crystal signal to another IC. This signal is an analog sine wave with low drive capability and, therefore, is not appropriate to drive an external digital input. A separate pin, CLKOUT, is provided for this purpose. The CLKOUT pin is set up using the MCLK\_OUT register (Address 0xF005). For a more detailed explanation of CLKOUT, refer to the Master Clock Output section or the register map description of the MCLK\_OUT register (see the CLKOUT Control Register section).

If a clock signal is provided from elsewhere in the system directly to the XTALIN/MCLK pin, the crystal resonator circuit is not necessary, and the XTALOUT pin can remain disconnected.

### Setting the Master Clock and PLL Mode

An integer PLL is available to generate the core system clock from the master clock input signal. The PLL generates the nominal 294.912 MHz core system clock to run the DSP core. As a result of the flexible clock generator circuitry, this nominal core clock frequency can be used for a variety of audio sample rates. An integer prescaler takes the clock signal from the MCLK pin and divides its frequency by 1, 2, 4, or 8 to meet the appropriate frequency range requirements for the PLL itself. The nominal input frequency to the PLL is 3.072 MHz. For systems with an 11.2896 MHz input master clock, the input to the PLL is 2.8224 MHz.

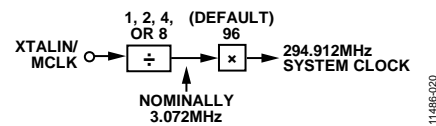

Figure 16. PLL Functional Block Diagram

The master clock input signal ranges in frequency from 2.375 MHz to 36 MHz. For systems that are intended to operate at a 48 kHz, 96 kHz, or 192 kHz audio sample rate, the typical master clock input frequencies are 3.072 MHz, 6.144 MHz, 12.288 MHz, and 24.576 MHz. Note that the flexibility of the PLL allows for a large range of other clock frequencies, as well.

The PLL in the ADAU1452 and ADAU1451 has a nominal (and maximum) output frequency of 294.912 MHz. The PLL of the ADAU1450 outputs a frequency at half the rate of the PLL of the ADAU1452 and ADAU1451, with a nominal (and maximum) output frequency of 147.456 MHz.

The PLL is configured by setting Register 0xF000 (PLL\_CTRL0), Register 0xF001 (PLL\_CTRL1), and Register 0xF002 (PLL\_CLK\_SRC). After these registers are modified, set Register 0xF003, Bit 0 (PLL\_ENABLE), forcing the PLL to reset itself and attempt to relock to the incoming clock signal. Typically, the PLL locks within 3.5 ms. When the PLL locks to an input clock and creates a stable output clock, a lock flag is set in Register 0xF004, Bit 0 (PLL\_LOCK).



### Example PLL Settings

Depending on the input clock frequency, there are several possible configurations for the PLL. Setting the PLL to generate the highest possible system clock, without exceeding the maximum, allows for the execution of more DSP program instructions for each audio frame. Alternatively, setting the PLL to generate a lower frequency system clock allows fewer instructions to be executed and also

lowers overall power consumption of the device. Table 25 shows several example MCLK frequencies and the corresponding PLL settings that allow for the highest number of program instructions to be executed for each audio frame. The settings provide the highest possible system clock without exceeding the 294.912 MHz upper limit (or 147.456 MHz in the case of the ADAU1450).

**Table 25. Optimal Predivider and Feedback Divider Settings for Varying Input MCLK Frequencies**

Input MCLK Frequency (MHz)	Predivider Setting	PLL Input Clock (MHz)	Feedback Divider Setting	ADAU1452 and ADAU1451 System Clock (MHz)	ADAU1450 System Clock (MHz)
2.8224	1	2.8224	104	293.5296	146.7648
3	1	3	98	294	147
3.072	1	3.072	96	294.912	147.456
3.5	1	3.5	84	294	147
4	1	4	73	292	146
4.5	1	4.5	65	292.5	146.25
5	2	2.5	117	292.5	146.25
5.5	2	2.75	107	294.25	147.125
5.6448	2	2.8224	104	293.5296	146.7648
6	2	3	98	294	147
6.144	2	3.072	96	294.912	147.456
6.5	2	3.25	90	292.5	146.25
7	2	3.5	84	294	147
7.5	2	3.75	78	292.5	146.25
8	2	4	73	292	146
8.5	2	4.25	69	293.25	146.625
9	2	4.5	65	292.5	146.25
9.5	4	2.375	124	294.5	147.25
10	4	2.5	117	292.5	146.25
10.5	4	2.625	112	294	147
11	4	2.75	107	294.25	147.125
11.2896	4	2.8224	104	293.5296	146.7648
11.5	4	2.875	102	293.25	146.625
12	4	3	98	294	147
12.288	4	3.072	96	294.912	147.456
12.5	4	3.125	94	293.75	146.875
13	4	3.25	90	292.5	146.25
13.5	4	3.375	87	293.625	146.8125
14	4	3.5	84	294	147
14.5	4	3.625	81	293.625	146.8125
15	4	3.75	78	292.5	146.25
15.5	4	3.875	76	294.5	147.25
16	4	4	73	292	146
16.5	4	4.125	71	292.875	146.4375
17	4	4.25	69	293.25	146.625
17.5	4	4.375	67	293.125	146.5625
18	4	4.5	65	292.5	146.25
18.5	8	2.3125	127	293.6875	146.84375
19	8	2.375	124	294.5	147.25
19.5	8	2.4375	120	292.5	146.25
20	8	2.5	117	292.5	146.25
20.5	8	2.5625	115	294.6875	147.34375
21	8	2.625	112	294	147



Input MCLK Frequency (MHz)	Predivider Setting	PLL Input Clock (MHz)	Feedback Divider Setting	ADAU1452 and ADAU1451 System Clock (MHz)	ADAU1450 System Clock (MHz)
21.5	8	2.6875	109	292.9375	146.46875
22	8	2.75	107	294.25	147.125
22.5	8	2.8125	104	292.5	146.25
22.5792	8	2.8224	104	293.5296	146.7648
23	8	2.875	102	293.25	146.625
23.5	8	2.9375	100	293.75	146.875
24	8	3	98	294	147
24.5	8	3.0625	96	294	147
24.576	8	3.072	96	294.912	147.456
25	8	3.125	94	293.75	146.875

**Relationship Between System Clock and Instructions per Sample**

The DSP core executes only a limited number of instructions within the span of each audio sample. The number of instructions that can be executed is a function of the system clock and the DSP core sample rate. The core sample rate is set by Register 0xF401 (START\_PULSE), Bits[4:0] (START\_PULSE).

The number of instructions that can be executed per sample is equal to the system clock frequency divided by the DSP core sample rate. However, the program RAM size is 8192 words; therefore, in cases where the maximum instructions per sample exceeds 8192, subroutines and loops must be utilized to make use of all available instructions (see Table 26).

**PLL Filter**

An external PLL filter is required to help the PLL maintain stability and to limit the amount of ripple appearing on the phase detector output of the PLL. For a nominal 3.072 MHz PLL input and a 294.912 MHz system clock output (or 147.456 MHz in the case of the ADAU1450), the recommended filter configuration is shown in Figure 17. This filter works for the full frequency range of the PLL.

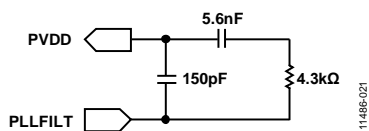

Figure 17. PLL Filter

Because the center frequency and bandwidth of the loop filter is determined by the values of the included components, use high accuracy (low tolerance) components. Components that are valued within 10% of the recommended component values and with a 15% or lower tolerance are suitable for use in the loop filter circuit.

The voltage on the PLLFILT pin, which is internally generated, is typically between 1.65 V and 2.10 V.

Table 26. Maximum Instructions Per Sample, Depending on System Clock and DSP Core Sample Rate

System Clock (MHz)	DSP Core Sample Rate (kHz)	Maximum Instructions per Sample
294.912	8	36,864 <sup>1</sup>
294.912	12	24,576 <sup>1</sup>
294.912	16	18,432 <sup>1</sup>
294.912	24	12,288 <sup>1</sup>
294.912	32	9216 <sup>1</sup>
294.912	48	6144
294.912	64	4608
294.912	96	3072
294.912	128	2304
294.912	192	1536
293.5296	11.025	26,624 <sup>1</sup>
293.5296	22.05	13,312 <sup>1</sup>
293.5296	44.1	6656
293.5296	88.2	3328
293.5296	176.4	1664
147.456	8	184320
147.456	12	122880
147.456	16	92160
147.456	24	61440
147.456	32	46080
147.456	48	30720
147.456	64	23040
147.456	96	15360
147.456	128	11520
147.456	192	7680
146.7648	11.025	133120
146.7648	22.05	66560
146.7648	44.1	33280
146.7648	88.2	16640
146.7648	176.4	8320

<sup>1</sup> The instructions per sample in these cases exceed the program memory size of 8192 words; therefore, to utilize the full number of instructions, subroutines or branches are required in the SigmaStudio program.

**Clock Generators**

Three clock generators are available to generate audio clocks for the serial ports, DSP, ASRCs, and other audio related functional blocks in the system. Each clock generator can be configured to generate a base frequency and several fractions or multiples of that base frequency, creating a total of 15 clock domains available for use in the system. Each of the 15 clock domains can create the appropriate LRCLK (frame clock) and BCLK (bit clock) signals for the serial ports. Five BCLK signals are generated at frequencies of 32 BCLK/sample, 64 BCLK/sample, 128 BCLK/sample, 256 BCLK/sample, and 512 BCLK/sample to deal with TDM data. Thus, with a single master clock input frequency, 15 different frame clock frequencies and 75 different bit clock frequencies can be generated for use in the system.

The nominal output of each clock generator is determined by the following formula:

$$Output\_Frequency = (Input\_Frequency \times N)/(1024 \times M)$$

where:

*Input\_Frequency* is the PLL output (nominally 294.912 MHz).

*Output\_Frequency* is the frame clock output frequency.

*N* and *M* are integers that are configured by writing to the clock generator configuration registers.

These calculations are also accurate in the case of the ADAU1450, even though the output rate of its PLL is half of that of the ADAU1452/ADAU1451.

In addition to the nominal output, four additional output signals are generated at double, quadruple, half, and a quarter of the frequency of the nominal output frequency.

For Clock Generator 1 and Clock Generator 2, the integer numerator (*N*) and the integer denominator (*M*) are each nine bits long. For Clock Generator 3, *N* and *M* are each 16 bits long, allowing for a higher precision when generating arbitrary clock frequencies.

Figure 18 shows a basic block diagram of the PLL and clock generators. Each division operator symbolizes that the frequency of the clock is divided when passing through that block. Each multiplication operator symbolizes that the frequency of the clock is multiplied when passing through that block.

Figure 19 shows an example where the master clock input has a frequency of 12.288 MHz, and the default settings are used for the PLL predivider, feedback divider, and Clock Generator 1 and Clock Generator 2. The resulting system clock is

$$12.288 \text{ MHz} \div 4 \times 96 = 294.912 \text{ MHz}$$

The base output of Clock Generator 1 is

$$294.912 \text{ MHz} \div 1024 \times 1 \div 6 = 48 \text{ kHz}$$

The base output of Clock Generator 2 is

$$294.912 \text{ MHz} \div 1024 \times 1 \div 9 = 32 \text{ kHz}$$

In this example, Clock Generator 3 is configured with *N* = 49 and *M* = 320; therefore, the resulting base output of Clock Generator 3 is

$$294.912 \text{ MHz} \div 1024 \times 49 \div 320 = 44.1 \text{ kHz}$$

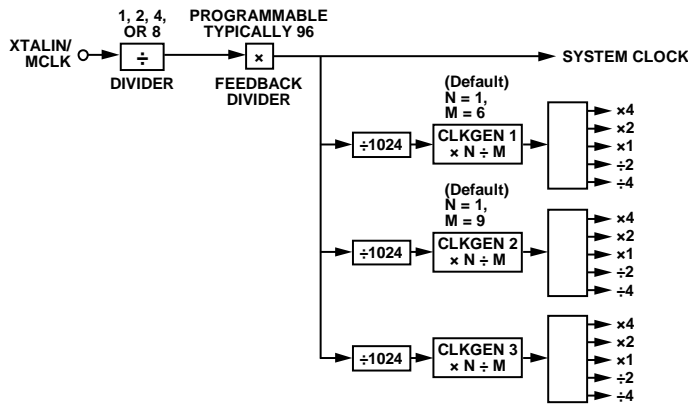

Figure 18. PLL and Clock Generators Block Diagram

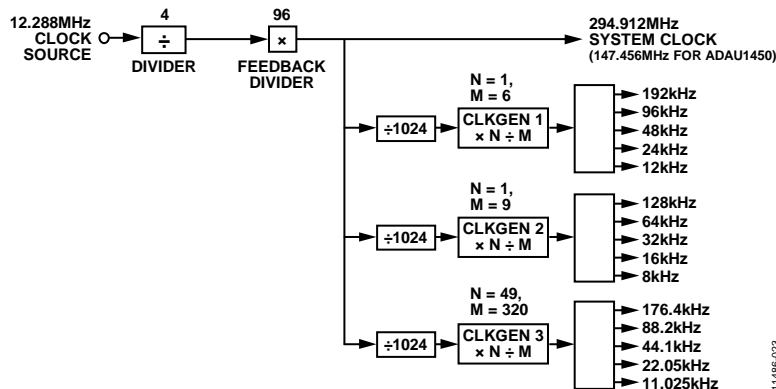

Figure 19. PLL and Audio Clock Generators with Default Settings and Resulting Clock Frequencies Labeled, XTALIN/MCLK = 12.288 MHz

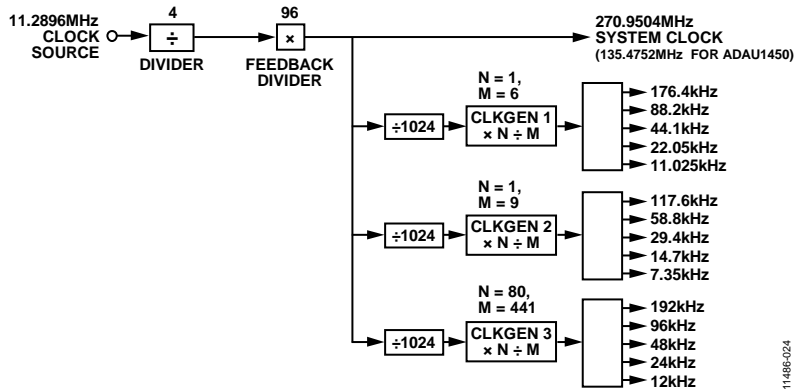

Figure 20. PLL and Audio Clock Generators with Default Settings and Resulting Clock Frequencies Labeled, XTALIN/MCLK = 11.2896 MHz

Figure 20 shows an example where the master clock input has a frequency of 11.2896 MHz, and the default settings are used for the PLL predivider, feedback divider, and Clock Generator 1 and Clock Generator 2. The resulting system clock is

$$11.2896 \text{ MHz} \div 4 \times 96 = 270.9504 \text{ MHz}$$

The base output of Clock Generator 1 is

$$270.9504 \text{ MHz} \div 1024 \times 1 \div 6 = 44.1 \text{ kHz}$$

The base output of Clock Generator 2 is

$$270.9504 \text{ MHz} \div 1024 \times 1 \div 9 = 29.4 \text{ kHz}$$

In this example, Clock Generator 3 is configured with N = 80 and M = 441; therefore, the resulting base output of Clock Generator 3 is

$$270.9504 \text{ MHz} \div 1024 \times 80 \div 441 = 48 \text{ kHz}$$

**Master Clock Output**

The master clock output pin (CLKOUT) is useful in cases where a master clock must be fed to other ICs in the system, such as audio codecs. The master clock output frequency is determined by the setting of the MCLK\_OUT register (Address 0xF005). Four frequencies are possible: 1×, 2×, 4×, or 8× the frequency of the predivider output.

- The predivider output × 1 generates a 3.072 MHz output for a nominal system clock of 294.912 MHz.
- The predivider output × 2 generates a 6.144 MHz output for a nominal system clock of 294.912 MHz.
- The predivider output × 4 generates a 12.288 MHz output for a nominal system clock of 294.912 MHz.
- The predivider output × 8 generates a 24.576 MHz output for a nominal system clock of 294.912 MHz.

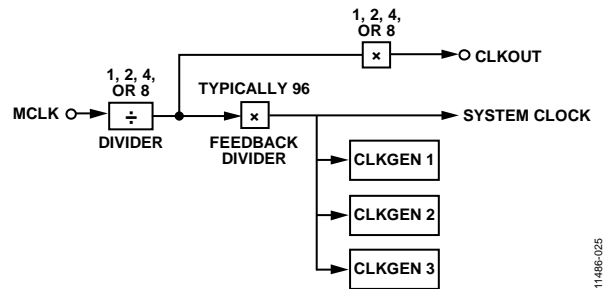

Figure 21. Clock Output Generator

The CLKOUT pin can drive more than one external slave IC if the drive strength is sufficient to drive the traces and external receiver circuitry. The ability to drive external ICs varies greatly, depending on the application and the characteristics of the PCB and the slave ICs. The drive strength and slew rate of the CLKOUT pin is configurable in the CLKOUT\_PIN register (Address 0xF7A3); thus, its performance can be tuned to match the specific application. The CLKOUT pin is not designed to drive long cables or other high impedance transmission lines. Use the CLKOUT pin only to drive signals to other integrated circuits on the same PCB. When changing the settings for the predivider, disable and then reenable the PLL using Register 0xF003 (PLL\_ENABLE), allowing the frequency of the CLKOUT signal to update.

**Dejitter Circuitry**

To account for jitter between ICs in the system and to handle interfacing safely between internal and external clocks, de-jitter circuits are included to guarantee that jitter related clocking errors are avoided. The dejitter circuitry is automated and does not require interaction or control from the user.

## Master Clock, PLL, and Clock Generators Registers

An overview of the registers related to the master clock, PLL, and clock generators is listed in Table 27. For a more detailed description, see the PLL Configuration Registers section and the Clock Generator Registers section.

**Table 27. Master Clock, PLL, and Clock Generator Registers**

Address	Register	Description
0xF000	PLL_CTRL0	PLL feedback divider
0xF001	PLL_CTRL1	PLL prescale divider
0xF002	PLL_CLK_SRC	PLL clock source
0xF003	PLL_ENABLE	PLL enable
0xF004	PLL_LOCK	PLL lock
0xF005	MCLK_OUT	CLKOUT control
0xF006	PLL_WATCHDOG	Analog PLL watchdog control
0xF020	CLK_GEN1_M	Denominator (M) for Clock Generator 1
0xF021	CLK_GEN1_N	Numerator (N) for Clock Generator 1
0xF022	CLK_GEN2_M	Denominator (M) for Clock Generator 2
0xF023	CLK_GEN2_N	Numerator (N) for Clock Generator 2
0xF024	CLK_GEN3_M	Denominator (M) for Clock Generator 3
0xF025	CLK_GEN3_N	Numerator (N) for Clock Generator 3
0xF026	CLK_GEN3_SRC	Input reference for Clock Generator 3
0xF027	CLK_GEN3_LOCK	Lock bit for Clock Generator 3 input reference

## POWER SUPPLIES, VOLTAGE REGULATOR, AND HARDWARE RESET

### Power Supplies

The ADAU1452/ADAU1451/ADAU1450 are supplied by four power supplies: IOVDD, DVDD, AVDD, and PVDD.

- IOVDD (input/output supply) sets the reference voltage for all digital input and output pins. It can be any value ranging from 1.8 V – 10% to 3.3 V + 10%. To use the I<sup>2</sup>C/SPI control ports or any of the digital input or output pins, the IOVDD supply must be present.
- DVDD (digital supply) powers the DSP core and supporting digital logic circuitry. It must be 1.2 V ± 5%.
- AVDD (analog supply) powers the analog auxiliary ADC circuitry. It must be supplied even if the auxiliary ADCs are not in use.
- PVDD (PLL supply) powers the PLL and acts as a reference for the voltage controlled oscillator (VCO). It must be supplied even if the PLL is not in use.

**Table 28. Power Supply Details**

Supply	Voltage	Externally Supplied?	Description
IOVDD (Input/Output)	1.8 V – 10% to 3.3 V + 10%	Yes	Can be derived from IOVDD using an internal LDO regulator
DVDD (Digital)	1.2 V ± 5%	Optional	
AVDD (Analog)	3.3 V ± 10%	Yes	
PVDD (PLL)	3.3 V ± 10%	Yes	

## Voltage Regulator

The ADAU1452/ADAU1451/ADAU1450 include a linear regulator that can generate the 1.2 V supply required by the DSP core and other internal digital circuitry from an external supply. Source the linear regulator from the I/O supply (IOVDD), which can range from 1.8 V – 10% to 3.3 V + 10%. A simplified block diagram of the internal structure of the regulator is shown in Figure 23.

For proper operation, the linear regulator requires several external components. A PNP bipolar junction transistor acts as an external pass device to bring the higher IOVDD voltage down to the lower DVDD voltage, thus externally dissipating the power of the IC package. Ensure that the current gain of the transistor ( $\beta$ ) is 200 or greater and the transistor is able to dissipate at least 1 W in the worst case. Place a 1 k $\Omega$  resistor between the transistor emitter and base to help stabilize the regulator for varying loads. This resistor placement also guarantees that current is always flowing into the VDRIVE pin, even for minimal regulator loads. Figure 22 shows the connection of the external components.

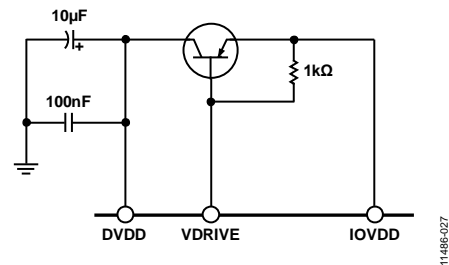

*Figure 22. External Components Required for Voltage Regulator Circuit*

If an external supply is provided to DVDD, ground the VDRIVE pin. The regulator continues to draw a small amount of current (around 100  $\mu$ A) from the IOVDD supply. Do not use the regulator to provide a voltage supply to external ICs. There are no control registers associated with the regulator.

### Power Reduction Modes

All sections of the IC have clock gating functionality that allows individual functional blocks to be disabled for power savings. Functional blocks that can optionally be powered down include the following:

- Clock Generator 1, Clock Generator 2, and Clock Generator 3
- S/PDIF receiver
- S/PDIF transmitter
- Serial data input and output ports
- Auxiliary ADC
- ASRCs (in two banks of eight channels each)
- PDM microphone inputs and decimation filters

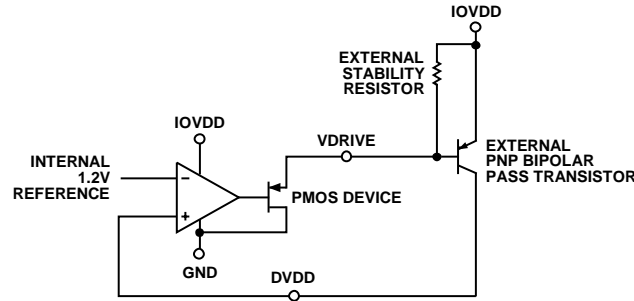

Figure 23. Simplified Block Diagram of Regulator Internal Structure, Including External Components

**Overview of Power Reduction Registers**

An overview of the registers related to power reduction is shown in Table 29. For a more detailed description, refer to the Power Reduction Registers section.

**Table 29. Power Reduction Registers**

Address	Register	Description
0xF050	POWER_ENABLE0	Disables clock generators, serial ports, and ASRCs
0xF051	POWER_ENABLE1	Disables PDM microphone inputs, S/PDIF interfaces, and auxiliary ADCs

**Hardware Reset**

An active low hardware reset pin ( $\overline{\text{RESET}}$ ) is available for externally triggering a reset of the device. When this pin is tied to ground, all functional blocks in the device are disabled, and the current consumption decreases dramatically. The amount of current drawn depends on the leakage current of the silicon, which depends greatly on the ambient temperature and the properties of the die. When the  $\overline{\text{RESET}}$  pin is connected to IOVDD, all control registers are reset to their power-on default values. The state of the RAM is not guaranteed to be cleared after a reset, so the memory must be manually cleared by the DSP program.

The default program generated by SigmaStudio includes code that automatically clears the memory. To ensure that no chatter exists on the  $\overline{\text{RESET}}$  signal line, implement an external reset generation circuit in the system hardware design. Figure 24 shows an example of the ADM811 microprocessor supervisory circuit with a push button connected, providing a method for manually generating a clean  $\overline{\text{RESET}}$  signal. For reliability purposes on the application level, place a weak pull-down resistor (in the range of several k $\Omega$ ) on the  $\overline{\text{RESET}}$  line to guarantee that the device is held in reset in the event that the reset supervisory circuitry fails.

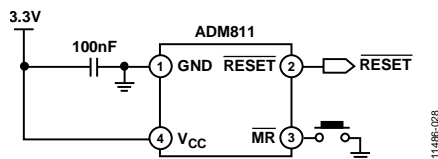

Figure 24. Example Manual Reset Generation Circuit

If the hardware reset function is not required in a system, pull the  $\overline{\text{RESET}}$  pin high to the IOVDD supply, using a weak pull-up resistor (in the range of several k $\Omega$ ). The device is designed to boot properly even when the  $\overline{\text{RESET}}$  pin is permanently pulled high.

**DSP Core Current Consumption**

The DSP core draws varying amounts of current, depending on the processing load required by the program it is running. Figure 25 shows the relationship between program size and digital (DVDD) current draw. The minimum of 0 MIPS signifies the case where no program is running in the DSP core, and the maximum of 294 MIPS signifies that the DSP core is at full utilization, executing a typical audio processing program.

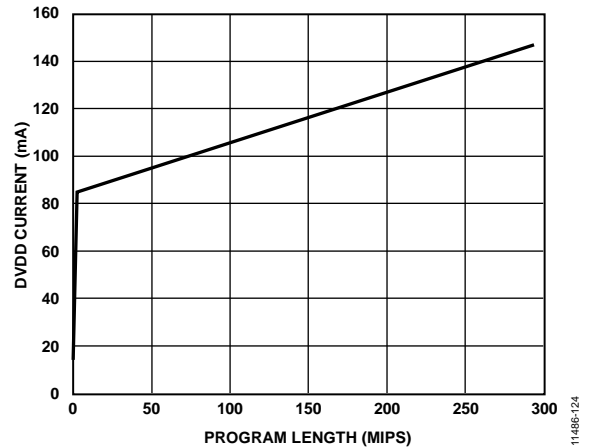

Figure 25. ADAU1452 Typical DVDD Current Draw vs. Program MIPS at an Ambient Temperature of 25°C and a Sample Rate of 48 kHz

**TEMPERATURE SENSOR DIODE**

The chip includes an on-board temperature sensor diode with an approximate range of 0°C to 120°C. The temperature sensor function is enabled by the two sides of a diode connected to the THD\_P and THD\_M pins. Value processing (calculating the actual temperature based on the current through the diode) is handled off chip by an external controller IC. The temperature value is not stored in an internal register; it is available only in the external controller IC. The temperature sensor requires an external IC to operate properly. The temperature value cannot be read by the on-board auxiliary ADC.

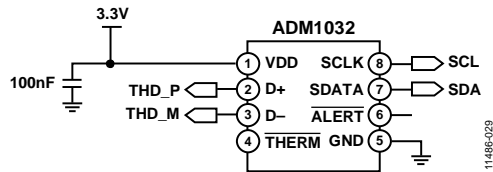

Figure 26. Example External Temperature Sensor Circuit

## SLAVE CONTROL PORTS

A total of four control ports are available: two slave ports and two master ports. The slave I2C port and slave SPI port allow an external master device to modify the contents of the memory and registers. The master I2C port and master SPI port allow the device to self boot and to send control messages to slave devices on the same bus.

### Slave Control Port Overview

To program the DSP and configure the control registers, a slave port is available that can communicate using either the I2C or SPI protocols. A separate master communications port can be used to self boot the chip by reading from an external EEPROM, or to boot or control external ICs by addressing them directly using I2C or SPI. The slave communications port defaults to I2C mode; however, it can be put into SPI mode by toggling SS (SS/ADDR0), the slave select pin, low three times. Each toggle should last at least the duration of one clock period of the clock on MCLK (XTALIN/MCLK), the master clock input pin. Until the PLL locks, only the PLL configuration registers (Address 0xF000 to Address 0xF004) are accessible. For this reason, always write to the PLL registers first after the chip powers up. After the PLL locks, the remaining registers and the RAM become accessible. See the System Initialization Sequence section for more information.

The control port is capable of full read/write operation for all addressable registers. The ADAU1452/ADAU1451/ADAU1450 must have a valid master clock to write to all registers, with the exception of Register 0xF000 to Register 0xF004. All addresses can be accessed in both single address mode and burst mode. The first byte (Byte 0) of a control port write contains the 7-bit chip address plus the R/W bit. The next two bytes (Byte 1 and Byte 2) together form the subaddress of the register location within the memory maps of the ADAU1452/ADAU1451/ADAU1450. This subaddress must be two bytes long because the memory locations within the devices are directly addressable, and their sizes exceed the range of single byte addressing. All sub-

Table 30. Control Port Pin Functions

Pin Name	I2C Slave Mode	SPI Slave Mode
SS/ADDR0	Address 0 (Bit 1 of the address word, input to the ADAU1452/ADAU1451/ADAU1450)	Slave select (input to the ADAU1452/ADAU1451/ADAU1450)
CCLK/SCL	Clock (input to the ADAU1452/ADAU1451/ADAU1450)	Clock (input to the ADAU1452/ADAU1451/ADAU1450)
MOSI/ADDR1	Address 1 (Bit 2 of the address word, input to the ADAU1452/ADAU1451/ADAU1450)	Data; master out, slave in (input to the ADAU1452/ADAU1451/ADAU1450)
MISO/SDA	Data (bidirectional, open collector)	Data; master in, slave out (output from the ADAU1452/ADAU1451/ADAU1450)

quent bytes (starting with Byte 3) contain the data, such as control port data, program data, or parameter data. The number of bytes per word depends on the type of data that is being written.

The ADAU1452/ADAU1451/ADAU1450 have several mechanisms for updating signal processing parameters in real time without causing pops or clicks.

If large blocks of data must be downloaded, halt the output of the DSP core (using Register 0xF400, HIBERNATE), load new data, and then restart the device (using Register 0xF402, START\_CORE). This process is typically performed during the booting sequence at startup or when loading a new program into RAM.

When updating a signal processing parameter while the DSP core is running, use the software safeload function to avoid a situation where a parameter is updated over the boundary of an audio frame, which can lead to an audio artifact such as a click or pop sound. For more information, see the Software Safeload section.

The slave control port pins are multifunctional, depending on the mode in which the device is operating. Table 30 describes these multiple functions.

### Burst Mode Writing and Reading

Burst write and read modes are available for convenience when writing large amounts of data to contiguous registers. In these modes, the chip and memory addresses are written once, and then a large amount of data can follow uninterrupted. The subaddresses are automatically incremented at the word boundaries. This increment happens automatically after a single word write or read unless a stop condition is encountered (I2C mode) or the slave select is disabled and brought high (SPI mode). A burst write starts like a single word write, but, following the first data-word, the data-word for the next address can be written immediately without sending its 2-byte address. The control registers in the ADAU1452/ADAU1451/ADAU1450 are two bytes wide, and the memories are four bytes wide. The autoincrement feature knows the word length at each subaddress; therefore, it is not necessary to manually specify the subaddress for each address in a burst write.

The subaddresses are automatically incremented by one address, following each read or write of a data-word, regardless of whether there is a valid register or RAM word at that address.



**I<sup>2</sup>C Slave Port**

The ADAU1452/ADAU1451/ADAU1450 support a 2-wire serial (I<sup>2</sup>C-compatible) micro-processor bus driving multiple peripherals. The maximum clock frequency on the I<sup>2</sup>C slave port is 400 kHz. Two pins, serial data (SDA) and serial clock (SCL), carry information between the ADAU1452/ADAU1451/ADAU1450 and the system I<sup>2</sup>C master controller. In I<sup>2</sup>C mode, the ADAU1452/ADAU1451/ADAU1450 are always slaves on the bus, meaning that they cannot initiate a data transfer. Each slave device is recognized by a unique address. The address bit sequence and the format of the read/write byte is shown in Table 31. The address resides in the first seven bits of the I<sup>2</sup>C write. The two address bits that follow can be set to assign the I<sup>2</sup>C slave address of the device, as follows: Bit 1 can be set by pulling the SS/ADDR0 pin either to IOVDD (by setting it to 1) or to GND (by setting it to 0); and Bit 2 can be set by pulling the MOSI/ADDR1 pin either to IOVDD

(by setting it to 1) or to GND (by setting it to 0). The LSB of the address (the R/W bit) specifies either a read or write operation. Logic Level 1 corresponds to a read operation; Logic Level 0 corresponds to a write operation.

Table 31 describes the sequence of eight bits that define the I<sup>2</sup>C device address byte.

Table 32 describes the relationship between the state of the address pins (0 represents logic low and 1 represents logic high) and the I<sup>2</sup>C slave address. Ensure that the address pins (SS/ADDR0 and MOSI/ADDR1) are hardwired in the design. Do not allow them to change states while the device is operating.

Place a 2 k $\Omega$  pull-up resistor on each line connected to the SDA and SCL pins. Ensure that the voltage on these signal lines does not exceed IOVDD (1.8 V – 10% to 3.3 V + 10%).

**Table 31. Address Bit Sequence**

Bit 7	Bit 6	Bit 5	Bit 4	Bit 3	Bit 2	Bit 1	Bit 0
0	1	1	1	0	ADDR1 (set by the MOSI/ADDR1 pin)	ADDR0 (set by the SS/ADDR0 pin)	R/W

**Table 32. I<sup>2</sup>C Slave Addresses**

MOSI/ADDR1	SS/ADDR0	Read/Write <sup>1</sup>	Slave Address (Eight Bits, Including R/W Bit)	Slave Address (Seven Bits, Excluding R/W Bit)
0	0	0	0x70	0x38
0	0	1	0x71	0x38
0	1	0	0x72	0x39
0	1	1	0x73	0x39
1	0	0	0x74	0x3A
1	0	1	0x75	0x3A
1	1	0	0x76	0x3B
1	1	1	0x77	0x3B

<sup>1</sup> 0 = write, 1 = read.

**Addressing**

Initially, each device on the I<sup>2</sup>C bus is in an idle state and monitors the SDA and SCL lines for a start condition and the proper address. The I<sup>2</sup>C master initiates a data transfer by establishing a start condition, defined by a high-to-low transition on SDA while SCL remains high. This indicates that an address/data stream follows. All devices on the bus respond to the start condition and shift the next eight bits (the 7-bit address plus the R/W bit), MSB first. The device that recognizes the transmitted address responds by pulling the data line low during the ninth clock pulse. This ninth bit is known as an acknowledge bit. All other devices withdraw from the bus at this point and return to the idle condition.

The R/W bit determines the direction of the data. A Logic 0 on the LSB of the first byte means that the master writes information to the peripheral, whereas a Logic 1 means that the master reads information from the peripheral after writing the subaddress and repeating the start address. A data transfer occurs until a stop condition is encountered. A stop condition occurs when SDA transitions from low to high while SCL is held high.

Figure 27 shows the timing of an I<sup>2</sup>C single word write operation, Figure 28 shows the timing of an I<sup>2</sup>C burst mode write operation, and Figure 29 shows an I<sup>2</sup>C burst mode read operation.

Stop and start conditions can be detected at any stage during the data transfer. If these conditions are asserted out of sequence with normal read and write operations, the slave I<sup>2</sup>C port of the ADAU1452/ADAU1451/ADAU1450 immediately jumps to the idle condition. During a given SCL high period, issue only one start condition and one stop condition, or a single stop condition followed by a single start condition. If the user issues an invalid subaddress, the ADAU1452/ADAU1451/ADAU1450 do not issue an acknowledge and return to the idle condition.

Note the following conditions:

- Do not issue an autoincrement (burst) write command that exceeds the highest subaddress in the memory.
- Do not issue an autoincrement (burst) write command that writes to subaddresses that are not defined in the Global RAM and Control Register Map section.

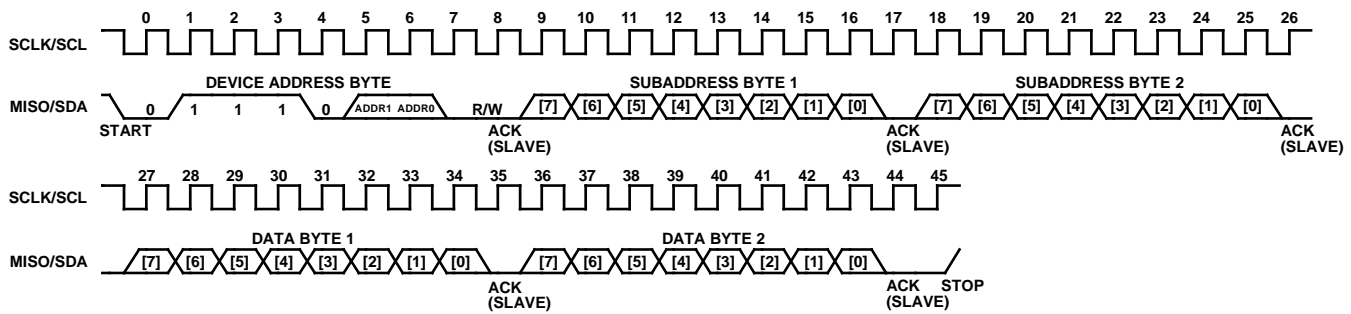

Figure 27. I<sup>2</sup>C Slave Single Word Write Operation (Two Bytes)

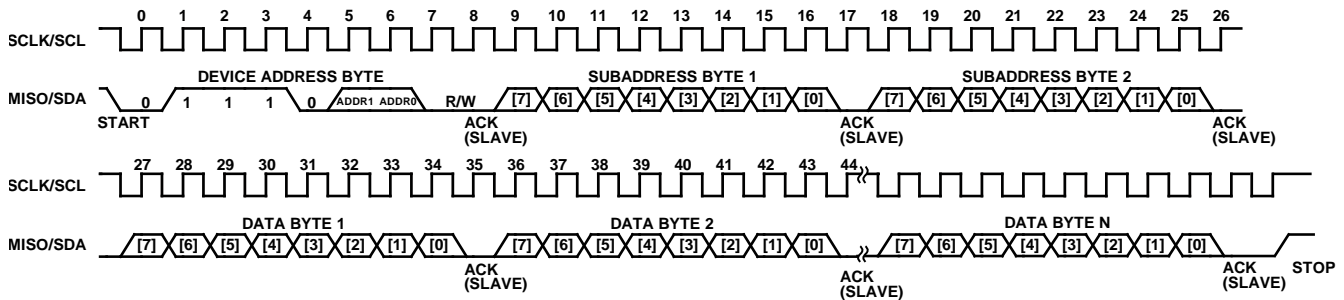

Figure 28. I<sup>2</sup>C Slave Burst Mode Write Operation (N Bytes)

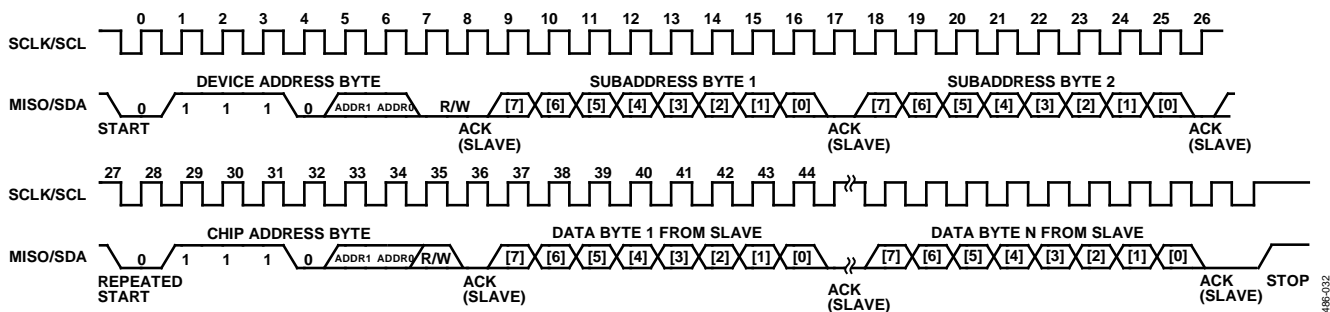

Figure 29. I<sup>2</sup>C Slave Burst Mode Read Operation (N Bytes)



**I<sup>2</sup>C Read and Write Operations**

Figure 30 shows the format of a single word write operation. Every ninth clock pulse, the ADAU1452/ADAU1451/ADAU1450 issue an acknowledge by pulling SDA low.

Figure 31 shows the simplified format of a burst mode write sequence. This figure shows an example of a write to sequential single byte registers. The ADAU1452/ADAU1451/ADAU1450 increment the subaddress register after every byte because the requested subaddress corresponds to a register or memory area with a 1-byte word length.

Figure 32 shows the format of a single word read operation. Note that the first R/W bit is 0, indicating a write operation. This is because the subaddress still needs to be written to set up the internal address. After the ADAU1452/ADAU1451/ADAU1450 acknowledge the receipt of the subaddress, the master must issue a repeated start command followed by the chip address byte with the R/W bit set to 1 (read). This causes the SDA pin of the device

to reverse and begin driving data back to the master. The master then responds every ninth pulse with an acknowledge pulse to the device.

Figure 33 shows the format of a burst mode read sequence. This figure shows an example of a read from sequential single byte registers. The ADAU1452/ADAU1451/ADAU1450 increment the subaddress register after every byte because the requested subaddress corresponds to a register or memory area with a 1-byte word length. The ADAU1452/ADAU1451/ADAU1450 always decode the subaddress and set the auto-increment circuit such that the address increments after the appropriate number of bytes.

Figure 30 to Figure 33 use the following abbreviations:

- S = start bit
- P = stop bit
- AM = acknowledge by master
- AS = acknowledge by slave

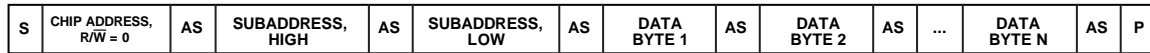

S = START BIT, P = STOP BIT, AM = ACKNOWLEDGE BY MASTER, AS = ACKNOWLEDGE BY SLAVE. SHOWS A ONE-WORD WRITE, WHERE EACH WORD HAS N BYTES.

Figure 30. Simplified Single Word I<sup>2</sup>C Write Sequence

11486-033

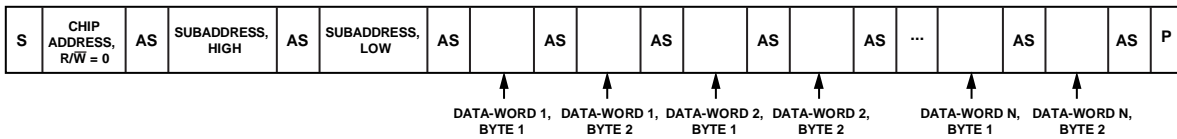

S = START BIT, P = STOP BIT, AM = ACKNOWLEDGE BY MASTER, AS = ACKNOWLEDGE BY SLAVE. SHOWS AN N-WORD WRITE, WHERE EACH WORD HAS TWO BYTES. (OTHER WORD LENGTHS ARE POSSIBLE, RANGING FROM ONE TO FIVE BYTES.)

Figure 31. Simplified Burst Mode I<sup>2</sup>C Write Sequence

11486-034



S = START BIT, P = STOP BIT, AM = ACKNOWLEDGE BY MASTER, AS = ACKNOWLEDGE BY SLAVE. SHOWS A ONE-WORD WRITE, WHERE EACH WORD HAS N BYTES.

Figure 32. Simplified Single Word I<sup>2</sup>C Read Sequence

11486-035

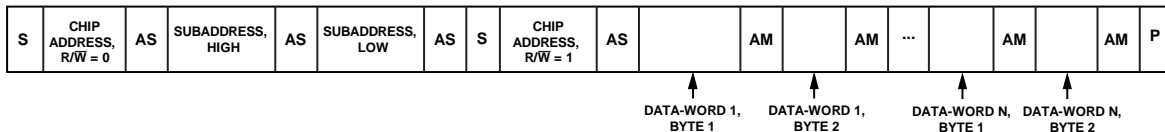

S = START BIT, P = STOP BIT, AM = ACKNOWLEDGE BY MASTER, AS = ACKNOWLEDGE BY SLAVE. SHOWS AN N-WORD WRITE, WHERE EACH WORD HAS TWO BYTES. (OTHER WORD LENGTHS ARE POSSIBLE, RANGING FROM ONE TO FIVE BYTES.)

Figure 33. Simplified Burst Mode I<sup>2</sup>C Read Sequence

11486-036

**SPI Slave Port**

By default, the slave port is in I<sup>2</sup>C mode, but it can be put into SPI control mode by pulling SS/ADDR0 low three times. This can be done either by toggling the SS/ADDR0 successively between logic high and logic low states, or by performing three dummy writes to the SPI port, writing any arbitrary data to any arbitrary subaddress (the slave port does not acknowledge these three writes). After the SS/ADDR0 is toggled three times, data can be written to or read from the IC. An example of dummy writing is shown in Figure 34. Once set in SPI slave mode, the only way to revert back to I<sup>2</sup>C slave mode is by executing a full hardware reset using the RESET pin or by power cycling the power supplies.

The SPI port uses a 4-wire interface, consisting of the SS, MOSI, MISO, and SCLK signals, and it is always a slave port. The SS signal goes low at the beginning of a transaction and high at the end of a transaction. The SCLK signal latches MOSI on a low-to-high transition. MISO data is shifted out of the device on the falling edge of SCLK and must be clocked into a receiving device, such as a microcontroller, on the SCLK rising edge. The MOSI signal carries the serial input data, and the MISO signal carries the serial output data. The MISO signal remains three-state until a read operation is requested. This allows other SPI-compatible peripherals to share the same MISO line. All SPI transactions have the same basic format shown in Table 34. A timing diagram is shown in Figure 9. Write all data MSB first.

There is only one chip address available in SPI mode. The 7-bit chip address is 0b0000000. The LSB of the first byte of an SPI transaction is an R/W bit. This bit determines whether the communication is a read (Logic Level 1) or a write (Logic Level 0). This format is shown in Table 33.

**Table 33. SPI Address and Read/Write Byte Format**

Bit 0	Bit 1	Bit 2	Bit 3	Bit 4	Bit 5	Bit 6	Bit 7
0	0	0	0	0	0	0	R/W

The 16-bit subaddress word is decoded into a location in one of the registers. This subaddress is the location of the appropriate register. The MSBs of the subaddress are zero padded to bring the word to a full 2-byte length.

The format for the SPI communications slave port is commonly known as SPI Mode 3, where clock polarity (CPOL) = 1 and clock phase (CPHA) = 1 (see Figure 35). The base value of the clock is 1. Data is captured on the rising edge of the clock, and data is propagated on the falling edge.

The maximum read and write speed for the SPI slave port is 22 MHz, but this speed is valid only after the PLL is locked. Before the PLL locks, the maximum clock rate in the chip is limited to the frequency of the input clock to the PLL. Nominally, this is 3.072 MHz. Therefore, the SPI clock must not exceed 3.072 MHz until the PLL lock completes.

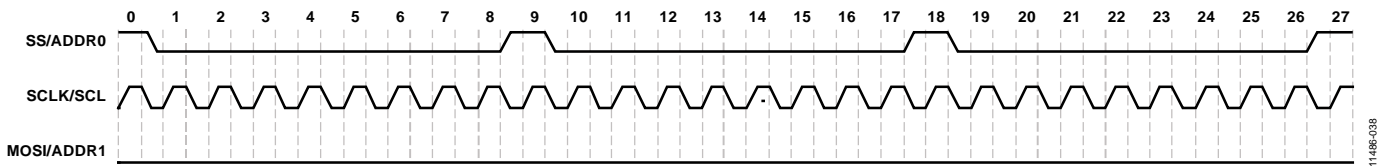

Figure 34. Example of SPI Slave Mode Initialization Sequence Using Dummy Writes

**Table 34. Generic Control Word Sequence**

Byte 0	Byte 1	Byte 2	Byte 3	Byte 4 and Subsequent Bytes
Chip Address[6:0], R/W	Subaddress[15:8]	Subaddress[7:0]	Data	Data

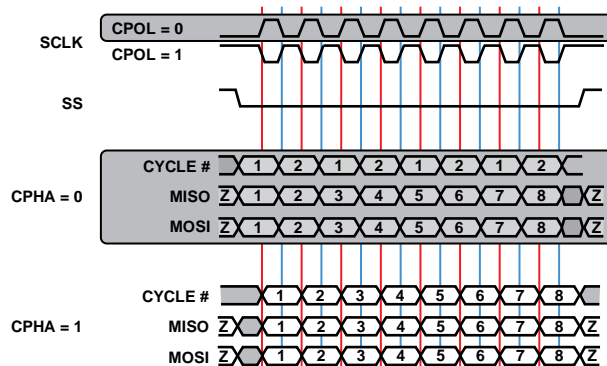

Figure 35. Clock Polarity and Phase for SPI Slave Port

A sample timing diagram for a multiple word SPI write operation to a register is shown in Figure 36. A sample timing diagram of a single word SPI read operation is shown in Figure 37. The MISO/SDA pin transitions from being three-state to being driven at the beginning of Byte 3. In this example, Byte 0 to Byte 2 contain

the addresses and the  $\overline{R/\overline{W}}$  bit, and subsequent bytes carry the data. A sample timing diagram of a multiple word SPI read operation is shown in Figure 38. In Figure 36 to Figure 38, rising edges on SCLK/SCL are indicated with an arrow, signifying that the data lines are sampled on the rising edge.

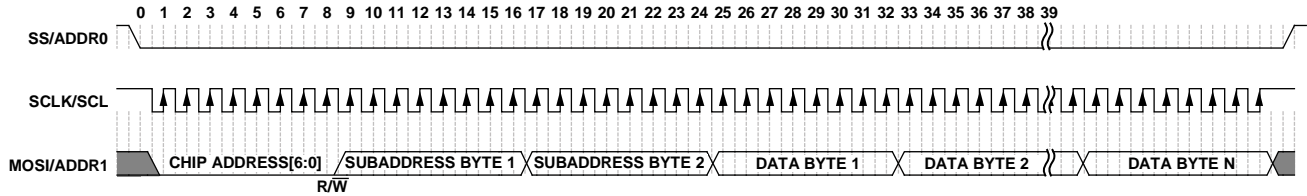

Figure 36. SPI Slave Write Clocking (Burst Write Mode, N Bytes)

11486-039

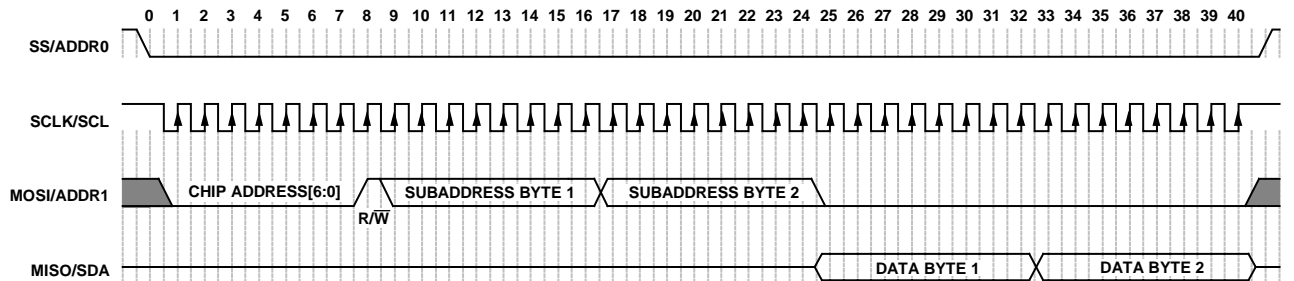

Figure 37. SPI Slave Read Clocking (Single Word Mode, Two Bytes)

11486-040

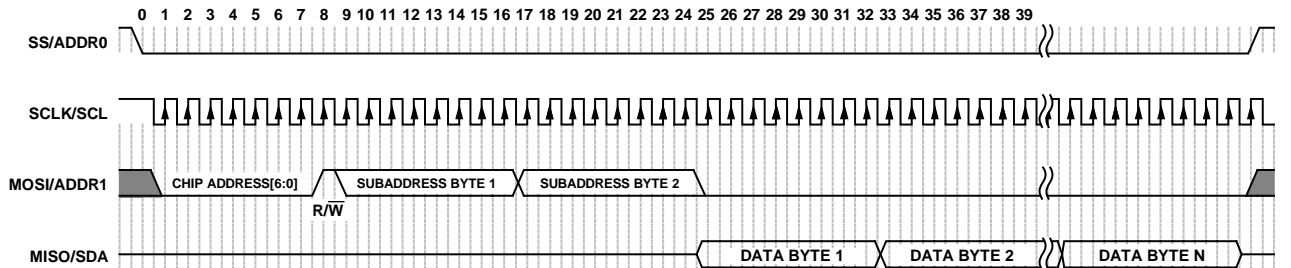

Figure 38. SPI Slave Read Clocking (Burst Read Mode, N Bytes)

11486-041

**MASTER CONTROL PORTS**

The device contains a combined I<sup>2</sup>C and SPI master control port that is accessible through a common interface. The master port can be enabled through a self boot operation or directly from the DSP core. The master control port can buffer up to 128 bits of data per single interrupt period. The smallest data transfer unit for both bus interfaces is one byte, and all transfers are 8-bit aligned. No error detection is supported, and single master operation is assumed. Only one bus interface protocol (I<sup>2</sup>C or SPI) can be used at a time.

The master control port can be used for several purposes, as follows:

- Self boot the [ADAU1452/ADAU1451/ADAU1450](#) from an external serial EEPROM.
- Boot and control external slave devices such as codecs and amplifiers.
- Read from and write to an external SPI RAM or flash memory.

**SPI Master Interface**

The SPI master supports up to seven slave devices (via the MPx pins) and speeds between 2.3 kHz and 20 MHz. SPI Mode 0 (CPOL = 0, CPHA = 0) and SPI Mode 3 (CPOL = 1, CPHA = 1) are supported. Communication is assumed to be half duplex, and the SPI master does not support a 3-wire interface. There is no JTAG or SGPIO support. The SPI interface uses a minimum of four general-purpose input/output pins of the processor and up to six additional MPx pins for additional slave select signals (SS). See Table 35 for more information.

**Table 35. SPI Master Interface Pin Functionality**

Pin Name	SPI Master Function	Description
MOSI_M/MP1	MOSI	SPI master port data output. Sends data from the SPI master port to slave devices on the SPI master bus.
SCL_M/SCLK_M/MP2	SCLK	SPI master port serial clock. Drives the clock signal to slave devices on the SPI master bus.
SDA_M/MISO_M/MP3	MISO	SPI master port data input. Receives data from slave devices on the SPI master bus.
SS_M/MP0	SS	SPI master port slave select. Acts as the primary slave select signal to slave device on the SPI master bus.
MP4 to MP13	SS	SPI master port slave select. These additional multipurpose pins can be configured to act as secondary slave select signals to additional slave devices on the SPI master bus. Up to seven slave devices, one per pin, are supported.

**Table 36. I<sup>2</sup>C Master Interface Pin Functionality**

Pin Name	I <sup>2</sup> C Master Function	Description
SCL_M/SCLK_M/MP2	SCL	I <sup>2</sup> C master port serial clock. This pin functions as an open collector output and drives a serial clock to slave devices on the I <sup>2</sup> C bus. The line connected to this pin must have a 2.0 kΩ pull-up resistor to IOVDD.
SDA_M/MISO_M/MP3	SDA	I <sup>2</sup> C master port serial data. This pin functions as a bidirectional open collector data line between the I <sup>2</sup> C master port and slave devices on the I <sup>2</sup> C bus. The line connected to this pin must have a 2.0 kΩ pull-up resistor to IOVDD.

The SPI master clock frequency can range between 2.3 kHz and 20 MHz. JTAG and SGPIO are not supported. Data transfers are 8-bit aligned. By default, the SPI master port is in Mode 3 (CPOL = 1, CPHA = 1), which matches the mode of the SPI slave port. The SPI master port can be configured to operate in Mode 0 (CPOL = 0, CPHA = 0) in the DSP program. No error detection or handling is implemented. Single master operation is assumed; therefore, no other master devices can exist on the same SPI bus.

The SPI master interface has been tested with EEPROM, flash, and serial RAM devices and has been confirmed to work in all cases.

When the data rate is very high on the SPI master interface (at 10 MHz or higher), a condition may arise where there is a high level of current draw on the IOVDD supply, which can lead to sagging of the internal IOVDD supply. To avoid potential issues, design the PCB such that the traces connecting the SPI master interface to external devices are kept as short as possible, and the slew rate and drive strength for SPI master interface pins are kept to a minimum to keep current draw as low as possible. Keeping IOVDD low (2.5 V or 1.8 V) also reduces the IOVDD current draw.

SigmaStudio generates EEPROM images for self boot systems, requiring no manual SPI master port configuration or programming on the part of the user.

**I<sup>2</sup>C Master Interface**

The I<sup>2</sup>C master is 7-bit addressable and supports standard and fast mode operation with speeds between 20 kHz and 400 kHz. The serial camera control bus (SCCB) and power management bus (PMBus) protocols are not supported. Data transfers are 8-bit aligned. No error detection or correction is implemented. The I<sup>2</sup>C master interface uses two general-purpose input/output pins, MP2 and MP3. See Table 36 for more information.

## SELF BOOT

The master control port is capable of booting the device from a single EEPROM by connecting the SELFBOOT pin to logic high (IOVDD) and powering up the power supplies while the RESET pin is pulled high. This initiates a self boot operation, in which the master control port downloads all required memory and register settings and automatically starts executing the DSP program without requiring external intervention or supervision. A self boot operation can also be triggered while the device is already in operation by initiating a rising edge of the RESET pin while the SELFBOOT pin is held high. When the self boot operation begins, the state of the SS\_M/MP0 pin determines whether the SPI master or the I<sup>2</sup>C master carries out the self boot operation. If the SS\_M/MP0 pin is connected to logic low, the I<sup>2</sup>C master port carries out the self boot operation. Otherwise, connect this pin to the slave select pin of the external slave device. The SPI master port then carries out the self boot operation.

When self booting from SPI, the chip assumes the following:

- The slave EEPROM is selected via the SS\_M/MP0 pin.
- The slave EEPROM has 16- or 24-bit addressing, giving it a total memory size of between 4 kb and 64 Mb.
- The slave EEPROM supports serial clock frequencies down to 1 MHz or lower (a majority of the self boot operation uses a much higher clock frequency, but the initial transactions are performed at a slower frequency).
- The data stored in the slave EEPROM follows the format described in the EEPROM Self Boot Data Format section.
- The data is stored in the slave EEPROM with the MSB first.
- The slave EEPROM supports SPI Mode 3.
- The slave EEPROM sequential read operation has the command of 0x03.
- The slave EEPROM can be accessed immediately after it is powered up, with no manual configuration required.

When self booting from I<sup>2</sup>C, the chip assumes the following:

- The slave EEPROM has I<sup>2</sup>C Address 0x50.
- The slave EEPROM has 16-bit addressing, giving it a size of between 16 kb and 512 kb.
- The slave EEPROM supports standard mode clock frequencies of 100 kHz and lower (a majority of the self boot operation uses a much higher clock frequency, but the initial transactions are performed at a slower frequency).
- The data stored in the slave EEPROM follows the format described in the EEPROM Self Boot Data Format section.
- The slave EEPROM can be accessed immediately after it is powered, with no manual configuration required.

### Self Boot Failure

The SPI or I<sup>2</sup>C master port attempts to self boot from the EEPROM three times. If all three self boot attempts fail, the SigmaDSP core issues a software panic and then enters a sleep state. During a self boot operation, the panic manager is unable to output a panic flag on a multipurpose pin. Therefore, the only way to debug a self boot failure is by reading back the status of Register 0xF427 (PANIC\_FLAG) and Register 0xF428 (PANIC\_CODE). The contents of Register 0xF428 indicate the nature of the failure.

### EEPROM Self Boot Data Format

The self boot EEPROM image is generated using the SigmaStudio software; thus, the user does not need to manually create the data that is stored in the EEPROM. However, for reference, the details of the data format are described in this section.

The EEPROM self boot format consists of a fixed header, an arbitrary number of variable length blocks, and a fixed footer. The blocks themselves consist of a fixed header and a block of data with a variable length. Each data block can be placed anywhere in the DSP memory through configuration of the block header.

**Header Format**

The self boot EEPROM header consists of 16 bytes of data, starting at the beginning of the internal memory of the slave EEPROM (Address 0). The header format (see Figure 39) consists of the following:

- 8-bit Sentinel 0xAA (shown in Figure 39 as 0b10101010)
- 24-bit address indicating the byte address of the header of the first block (normally this is 0x000010, which is the address immediately following the header)
- 64-bit PLL configuration (PLL\_CHECKSUM = PLL\_FB\_DIV + MCLK\_OUT + PLL\_DIV)

**Data Block Format**

Following the header, several data blocks are stored in the EEPROM memory (see Figure 40).

Each data block consists of eight bytes that configure the length and address of the data, followed by a series of 4-byte data packets.

Each block consists of the following:

- One LST bit, which signals the last block before the footer. LST = 0b1 indicates the last block; LST = 0b0 indicates that additional blocks are still to follow.
- 13 bits that are reserved for future use. Set these bits to 0b0.

- Two MEM bits that select the target data memory bank (0x0 = Data Memory 0, 0x1 = Data Memory 1, 0x2 = program memory).
- 16-bit base address that sets the memory address at which the master port starts writing when loading data from the block into memory.
- 16-bit data length that defines the number of 4-byte data-words to be written.
- 16-bit jump address that tells the DSP core at which address in program memory it should begin execution when the self boot operation is complete. The jump address bits are ignored unless the LST bit is set to 0b1.
- Arbitrary number of packets of 32-bit data. The number of packets is defined by the 16-bit data length.

**Footer Format**

After all the data blocks, a footer signifies the end of the self boot EEPROM memory (see Figure 41). The footer consists of a 64-bit checksum, which is the sum of the header and all blocks and all data as 32-bit words.

After the self boot operation completes, the checksum of the downloaded data is calculated and the panic manager signals if it does not match the checksum in the EEPROM. If the checksum is set to 0 dec, the checksum checking is disabled.

BYTE 0		BYTE 1		BYTE 2		BYTE 3	
1	0	1	0	1	0	1	0
ADDRESS OF FIRST BOOT BLOCK							
BYTE 4		BYTE 5		BYTE 6		BYTE 7	
0x00		PLL_DIV		0x00		PLL_FB_DIV	
BYTE 8		BYTE 9		BYTE 10		BYTE 11	
0x00		PLL_CHECKSUM		0x00		MCLK_OUT	
BYTE 12		BYTE 13		BYTE 14		BYTE 15	
EEPROM SPEED CONFIGURATION							

Figure 39. Self Boot EEPROM Header Format

BYTE 0		BYTE 1		BYTE 2		BYTE 3	
LST	RESERVED			MEM	BASE ADDRESS		
BYTE 4		BYTE 5		BYTE 6		BYTE 7	
DATA LENGTH				JUMP ADDRESS			
BYTE 8		BYTE 9		BYTE 10		BYTE 11	
DATA-WORD 1							
BYTE 12		BYTE 13		BYTE 14		BYTE 15	
DATA-WORD 2							
CONTINUED UNTIL LAST WORD IS REACHED...							
FOURTH TO LAST BYTE		THIRD TO LAST BYTE		SECOND TO LAST BYTE		LAST BYTE	
DATA-WORD N							

Figure 40. Self Boot EEPROM Data Block Format

BYTE 0		BYTE 1		BYTE 2		BYTE 3	
FIRST FOUR BYTES OF CHECKSUM							
BYTE 4		BYTE 5		BYTE 6		BYTE 7	
LAST FOUR BYTES OF CHECKSUM							

Figure 41. Self Boot EEPROM Footer Format

**Considerations When Using a 1 Mb I<sup>2</sup>C Self Boot EEPROM**

Because of the way I<sup>2</sup>C addressing works, 1 Mb of I<sup>2</sup>C EEPROM memory can be divided, with a portion of its address space at Chip Address 0x50; another portion of the memory can be located at a different address (for example, Chip Address 0x51). The memory allocation varies, depending on the EEPROM design. In cases when the EEPROM memory is divided, the memory portion that resides at a different chip address must be handled as though it exists in a separate EEPROM.

**Considerations When Using Multiple EEPROMs on the SPI Master Bus**

When multiple EEPROMs are connected on the same SPI master bus, the self boot mechanism works only with the first EEPROM.

**AUDIO SIGNAL ROUTING**

A large number of audio inputs and outputs are available in the device, and control registers are available for configuring the way in which the audio is routed between different functional blocks.

The ADAU1450 does not include an S/PDIF receiver, S/PDIF transmitter, or ASRCs, so signals cannot be routed to or from those subsystems.

All input channels are accessible by both the DSP core and the ASRCs. Each ASRC can connect to a pair of audio channels from any of the input sources or from the DSP\_TO\_ASRC channels of the DSP core. The serial outputs can obtain their data from a number of sources, including the DSP core, ASRCs, PDM microphones, S/PDIF receiver, or directly from the serial inputs.

See Figure 42 for an overview of the audio routing matrix with its available audio data connections.

To route audio to and from the DSP core, select the appropriate input and output cells in SigmaStudio. These cells can be found in the IO folder of the SigmaStudio algorithm toolbox.

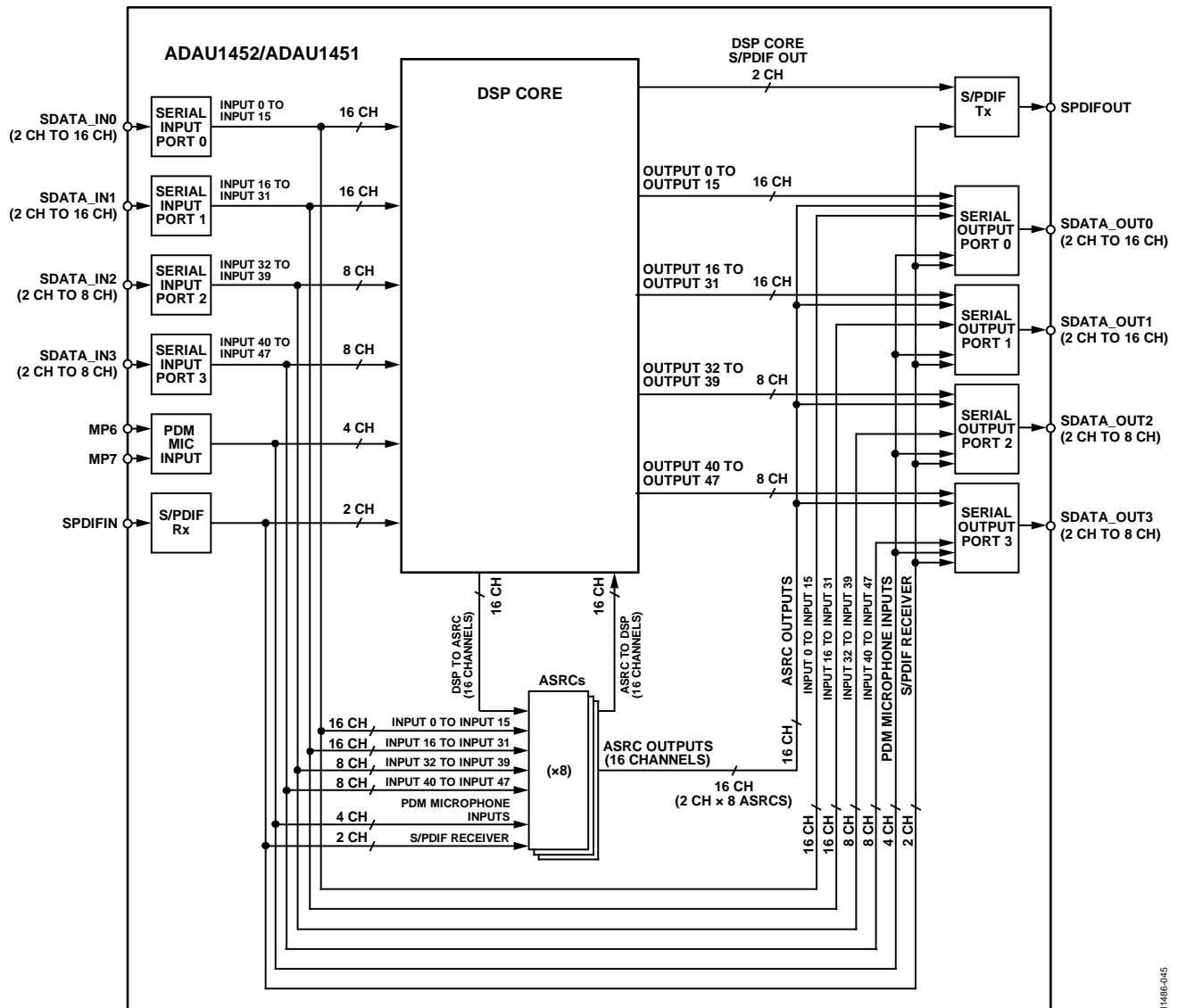

Figure 42. Audio Routing Overview

## Serial Audio Inputs to DSP Core

The 48 serial input channels are mapped to four audio input cells in SigmaStudio. Each input cell corresponds to one of the serial input pins (see Table 37).

Depending on whether the serial port is configured in 2-channel, 4-channel, 8-channel, or 16-channel mode, the available channels in SigmaStudio change. The channel count for each serial port is configured in the SERIAL\_BYTE\_x\_0 registers, Bits[2:0] (TDM\_MODE), at Address 0xF200 to Address 0xF21C (in increments of 0x4).

Figure 43 shows how the input pins map to the input cells in SigmaStudio, including their graphical appearance in the software.

**Table 37. Serial Input Pin Mapping to SigmaStudio Input Cells**

Serial Input Pin	Channels in SigmaStudio
SDATA_IN0	0 to 15
SDATA_IN1	16 to 31
SDATA_IN2	32 to 39
SDATA_IN3	40 to 47

**Table 38. Detailed Serial Input Mapping to SigmaStudio Input Channels<sup>1</sup>**

Serial Input Pin	Position in I <sup>2</sup> S Stream (2-Channel)	Position in TDM4 Stream	Position in TDM8 Stream	Position in TDM16 Stream	Input Channel in SigmaStudio
SDATA_IN0	Left	0	0	0	0
SDATA_IN0	Right	1	1	1	1
SDATA_IN0	N/A	2	2	2	2
SDATA_IN0	N/A	3	3	3	3
SDATA_IN0	N/A	N/A	4	4	4
SDATA_IN0	N/A	N/A	5	5	5
SDATA_IN0	N/A	N/A	6	6	6
SDATA_IN0	N/A	N/A	7	7	7
SDATA_IN0	N/A	N/A	N/A	8	8
SDATA_IN0	N/A	N/A	N/A	9	9
SDATA_IN0	N/A	N/A	N/A	10	10
SDATA_IN0	N/A	N/A	N/A	11	11
SDATA_IN0	N/A	N/A	N/A	12	12
SDATA_IN0	N/A	N/A	N/A	13	13
SDATA_IN0	N/A	N/A	N/A	14	14
SDATA_IN0	N/A	N/A	N/A	15	15
SDATA_IN1	Left	0	0	0	16
SDATA_IN1	Right	1	1	1	17
SDATA_IN1	N/A	2	2	2	18
SDATA_IN1	N/A	3	3	3	19
SDATA_IN1	N/A	N/A	4	4	20
SDATA_IN1	N/A	N/A	5	5	21
SDATA_IN1	N/A	N/A	6	6	22
SDATA_IN1	N/A	N/A	7	7	23
SDATA_IN1	N/A	N/A	N/A	8	24
SDATA_IN1	N/A	N/A	N/A	9	25
SDATA_IN1	N/A	N/A	N/A	10	26
SDATA_IN1	N/A	N/A	N/A	11	27
SDATA_IN1	N/A	N/A	N/A	12	28
SDATA_IN1	N/A	N/A	N/A	13	29
SDATA_IN1	N/A	N/A	N/A	14	30
SDATA_IN1	N/A	N/A	N/A	15	31
SDATA_IN2	Left	0	0	0	32
SDATA_IN2	Right	1	1	1	33
SDATA_IN2	N/A	2	2	2	34
SDATA_IN2	N/A	3	3	3	35
SDATA_IN2	N/A	N/A	4	4	36
SDATA_IN2	N/A	N/A	5	5	37
SDATA_IN2	N/A	N/A	6	6	38
SDATA_IN2	N/A	N/A	7	7	39



Serial Input Pin	Position in I <sup>2</sup> S Stream (2-Channel)	Position in TDM4 Stream	Position in TDM8 Stream	Position in TDM16 Stream	Input Channel in SigmaStudio
SDATA_IN3	Left	0	0	0	40
SDATA_IN3	Right	1	1	1	41
SDATA_IN3	N/A	2	2	2	42
SDATA_IN3	N/A	3	3	3	43
SDATA_IN3	N/A	N/A	4	4	44
SDATA_IN3	N/A	N/A	5	5	45
SDATA_IN3	N/A	N/A	6	6	46
SDATA_IN3	N/A	N/A	7	7	47

<sup>1</sup> N/A = not applicable.

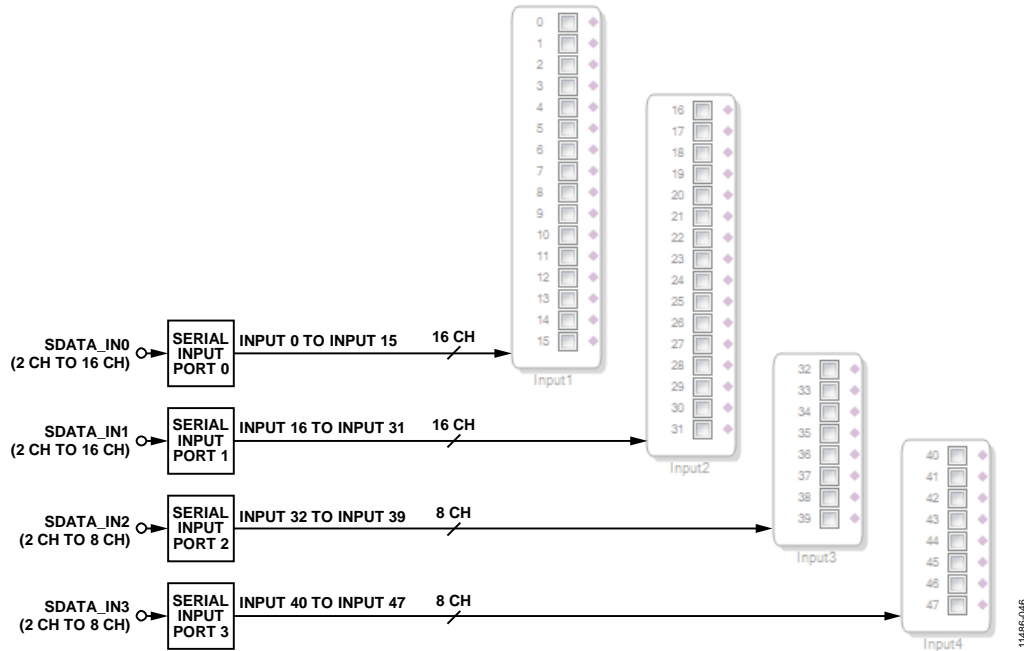

Figure 43. Serial Port Audio Input Mapping to DSP in SigmaStudio

**PDM Microphone Inputs to DSP Core**

The PDM microphone inputs are mapped to a single digital microphone input cell in SigmaStudio (see Table 39 and Figure 44). The corresponding hardware pins are configured in Register 0xF560 (DMIC\_CTRL0) and Register 0xF561 (DMIC\_CTRL1).

**Table 39. PDM Microphone Input Mapping to SigmaStudio Channels**

PDM Data Channel	PDM Microphone Input Channel in SigmaStudio
Left (DMIC_CTRL0)	0
Right (DMIC_CTRL0)	1
Left (DMIC_CTRL1)	2
Right (DMIC_CTRL1)	3

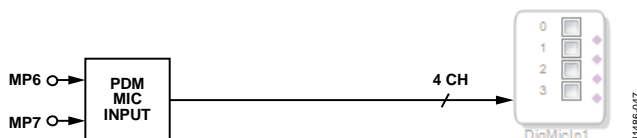

Figure 44. PDM Microphone Input Mapping to DSP in SigmaStudio

**S/PDIF Receiver Inputs to DSP Core**

The S/PDIF receiver can be accessed directly in the DSP core by using the S/PDIF input cell. However, in most applications, the S/PDIF receiver input is asynchronous to the DSP core, so an ASRC is typically required; in such cases, the S/PDIF input cell must not be used.

**Table 40. S/PDIF Input Mapping to SigmaStudio Channels**

Channel in S/PDIF Receiver Data Stream	S/PDIF Input Channels in SigmaStudio
Left	0
Right	1

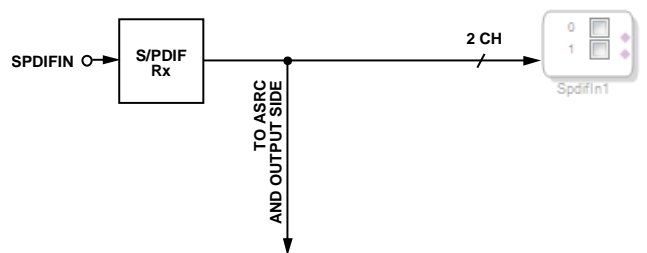

Figure 45. S/PDIF Receiver Direct Input Mapping to DSP in SigmaStudio

**Serial Audio Outputs from DSP Core**

The 48 serial output channels are mapped to 48 separate audio output cells in SigmaStudio. Each audio output cell corresponds to a single output channel. The first 16 channels are mapped to

the SDATA\_OUT0 pin. The next 16 channels are mapped to the SDATA\_OUT1 pin. The following eight channels are mapped to the SDATA\_OUT2 pin. The last eight channels are mapped to the SDATA\_OUT3 pin (see Table 41 and Figure 46).

**Table 41. Serial Output Pin Mapping from SigmaStudio Channels<sup>1</sup>**

Channel in SigmaStudio	Serial Output Pin	Position in I <sup>2</sup> S Stream (2-Channel)	Position in TDM4 Stream	Position in TDM8 Stream	Position in TDM16 Stream
0	SDATA_OUT0	Left	0	0	0
1	SDATA_OUT0	Right	1	1	1
2	SDATA_OUT0	N/A	2	2	2
3	SDATA_OUT0	N/A	3	3	3
4	SDATA_OUT0	N/A	N/A	4	4
5	SDATA_OUT0	N/A	N/A	5	5
6	SDATA_OUT0	N/A	N/A	6	6
7	SDATA_OUT0	N/A	N/A	7	7
8	SDATA_OUT0	N/A	N/A	N/A	8
9	SDATA_OUT0	N/A	N/A	N/A	9
10	SDATA_OUT0	N/A	N/A	N/A	10
11	SDATA_OUT0	N/A	N/A	N/A	11
12	SDATA_OUT0	N/A	N/A	N/A	12
13	SDATA_OUT0	N/A	N/A	N/A	13
14	SDATA_OUT0	N/A	N/A	N/A	14
15	SDATA_OUT0	N/A	N/A	N/A	15
16	SDATA_OUT1	Left	0	0	0
17	SDATA_OUT1	Right	1	1	1
18	SDATA_OUT1	N/A	2	2	2
19	SDATA_OUT1	N/A	3	3	3
20	SDATA_OUT1	N/A	N/A	4	4
21	SDATA_OUT1	N/A	N/A	5	5
22	SDATA_OUT1	N/A	N/A	6	6
23	SDATA_OUT1	N/A	N/A	7	7
24	SDATA_OUT1	N/A	N/A	N/A	8
25	SDATA_OUT1	N/A	N/A	N/A	9
26	SDATA_OUT1	N/A	N/A	N/A	10
27	SDATA_OUT1	N/A	N/A	N/A	11
28	SDATA_OUT1	N/A	N/A	N/A	12
29	SDATA_OUT1	N/A	N/A	N/A	13
30	SDATA_OUT1	N/A	N/A	N/A	14
31	SDATA_OUT1	N/A	N/A	N/A	15
32	SDATA_OUT2	Left	0	0	0
33	SDATA_OUT2	Right	1	1	1
34	SDATA_OUT2	N/A	2	2	2
35	SDATA_OUT2	N/A	3	3	3
36	SDATA_OUT2	N/A	N/A	4	4
37	SDATA_OUT2	N/A	N/A	5	5
38	SDATA_OUT2	N/A	N/A	6	6
39	SDATA_OUT2	N/A	N/A	7	7
40	SDATA_OUT3	Left	0	0	0
41	SDATA_OUT3	Right	1	1	1
42	SDATA_OUT3	N/A	2	2	2
43	SDATA_OUT3	N/A	3	3	3
44	SDATA_OUT3	N/A	N/A	4	4
45	SDATA_OUT3	N/A	N/A	5	5
46	SDATA_OUT3	N/A	N/A	6	6
47	SDATA_OUT3	N/A	N/A	7	7

<sup>1</sup> N/A = not applicable.

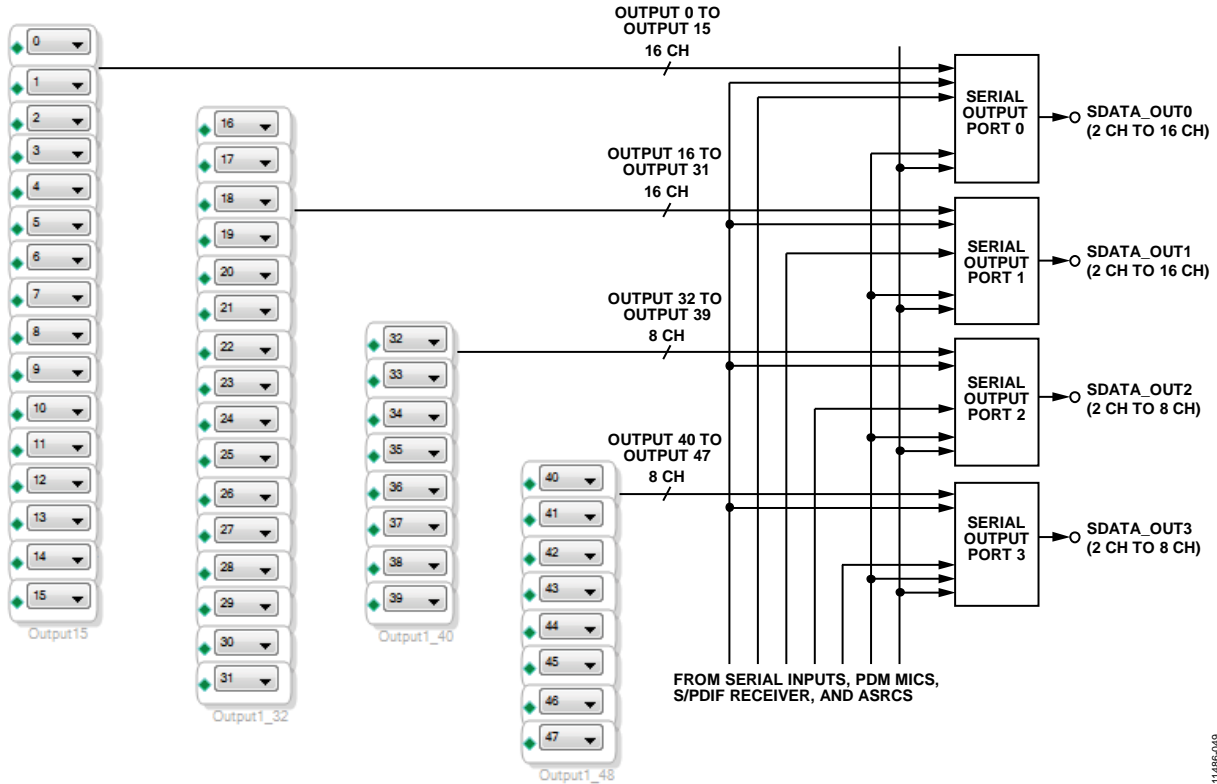

Figure 46. DSP to Serial Output Mapping in SigmaStudio

The data that is output from each serial output pin is also configurable, via the SOUT\_SOURCEx registers, to originate from one of the following sources: the DSP, the serial inputs, the PDM microphone inputs, the S/PDIF receiver, or the ASRCs. These registers can be configured graphically in SigmaStudio, as shown in Figure 47.

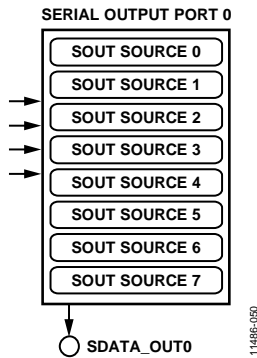

Figure 47. Configuring the Serial Output Data Channels (SOUT\_SOURCEx Registers) Graphically in SigmaStudio

**S/PDIF Audio Outputs from DSP Core to S/PDIF Transmitter**

The output signal of the S/PDIF transmitter can come from the DSP core or directly from the S/PDIF receiver. The selection is controlled by Register 0xF1C0 (SPDIFTX\_INPUT).

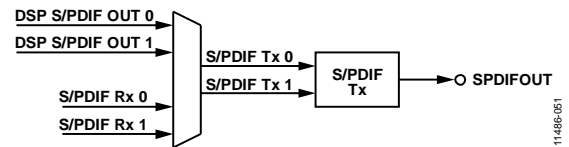

Figure 48. S/PDIF Transmitter Source Selection

When the signal comes from the DSP core, use the S/PDIF output cells in SigmaStudio.

**Table 42. S/PDIF Output Mapping from SigmaStudio Channels**

S/PDIF Output Channel in SigmaStudio	Channel in S/PDIF Transmitter Data Stream
0	Left
1	Right

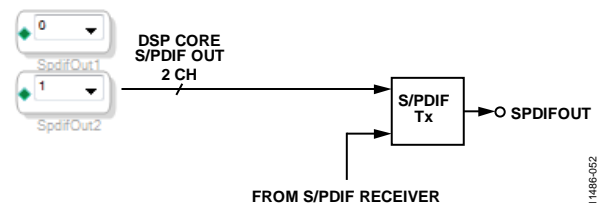

Figure 49. DSP to S/PDIF Transmitter Output Mapping in SigmaStudio

**Asynchronous Sample Rate Converter Input Routing**

Any asynchronous input can be routed to the ASRCs to be resynchronized to a desired target sample rate (see Figure 50). The source signals for any ASRC can come from any of the serial inputs, any of the DSP-to-ASRC channels, the S/PDIF receiver, or the digital PDM microphone inputs. There are eight ASRCs, each with two input channels and two output channels. This means a total of 16 channels can pass through the ASRCs.

Asynchronous input signals (either serial inputs, PDM microphone inputs, or the S/PDIF input) typically need to be routed to an ASRC and then synchronized to the DSP core rate. They are then available for input to the DSP core for processing.

In the example shown in Figure 51, the two channels from the S/PDIF receiver are routed to one of the ASRCs and then to the DSP core. For this example, the corresponding ASRC input selector register (Register 0xF100 to Register 0xF107, ASRC\_INPUTx), Bits[2:0] (ASRC\_SOURCE) is set to 0b011 to take the input from the S/PDIF receiver. Likewise, the corresponding ASRC output rate selector register (Register 0xF140 to Register 0xF147, ASRC\_OUT\_RATEx, Bits[3:0] (ASRC\_RATE)) is set to 0b0101 to synchronize the ASRC output data to the DSP core sample rate.

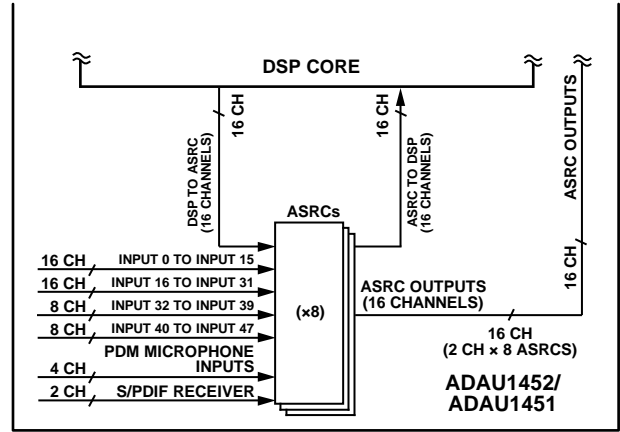

Figure 50. Channel Routing to ASRC Inputs

11486-053

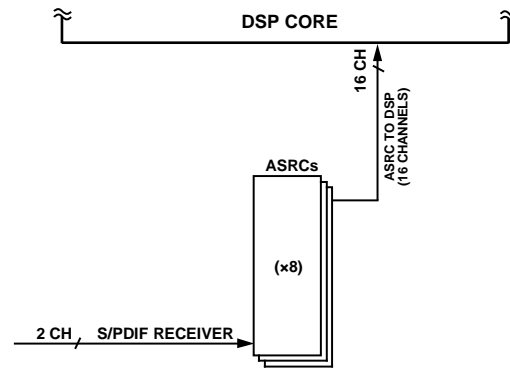

Figure 51. Example ASRC Routing for Asynchronous Input to the DSP Core

11486-054

When the outputs of the ASRCs are required for processing in the SigmaDSP core, the ASRC input block must be selected in SigmaStudio (see Figure 52 and Figure 53). In the case of the ADAU1450, which has no ASRCs, the ASRC input cell does not generate any data.

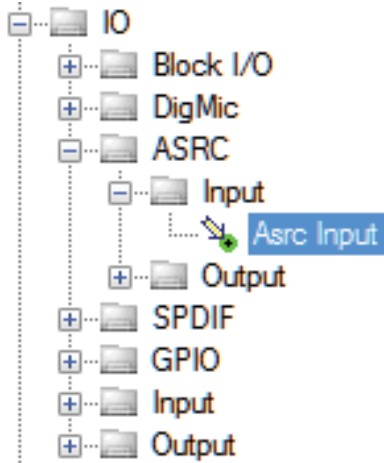

Figure 52. Location of ASRC-to-DSP Input Cell in SigmaStudio Toolbox

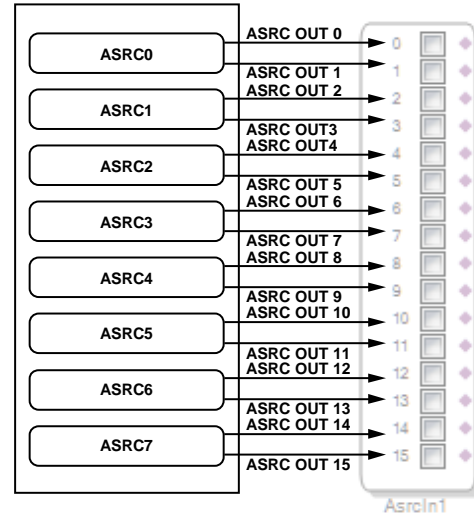

Figure 53. Routing of ASRC Outputs to ASRC-to-DSP Input Cell in SigmaStudio

Asynchronous output signals (for example, serial outputs that are slaves to an external, asynchronous device) typically are routed from the DSP core into the ASRCs, where they are synchronized to the serial output port that is acting as a slave to the external asynchronous master device.

In the example shown in Figure 54, two (or more) audio channels from the DSP core are routed to one (or more) of the ASRCs and then to the serial outputs. For this example, the corresponding ASRC input selector register (Address 0xF100 to Address 0xF107 (ASRC\_INPUTx), Bits[2:0] (ASRC\_SOURCE)) is set to 0b010 to take the data from the DSP core, and the corresponding ASRC output rate selector register (Address 0xF140 to Address 0xF147 (ASRC\_OUT\_RATEx), Bits[3:0] (ASRC\_RATE)) is set to one of the following:

- 0b0001 to synchronize the ASRC output data to SDATA\_OUT0
- 0b0010 to synchronize the ASRC output data to SDATA\_OUT1
- 0b0011 to synchronize the ASRC output data to SDATA\_OUT2
- 0b0100 to synchronize the ASRC output data to SDATA\_OUT3

Next, the corresponding serial output port data source register (Address 0xF180 to Address 0xF197 (SOUT\_SOURCEx), Bits[2:0] (SOUT\_SOURCE)) must be set to 0b011 to receive the data from the ASRC outputs, and Bits[5:3] (SOUT\_ASRC\_SELECT) must be configured to select the correct ASRC from which to receive the output data.

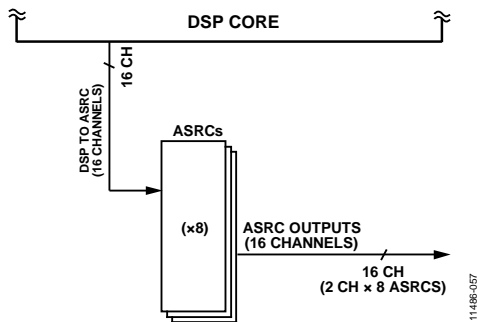

Figure 54. Example ASRC Routing for Asynchronous Serial Output from the DSP Core

When signals must route from the DSP core to the ASRCs, use the DSP-to-ASRC output cell in SigmaStudio (see Figure 55). In the case of the ADAU1450, which has no ASRCs, data routed to the DSP-to-ASRC output cells are lost.

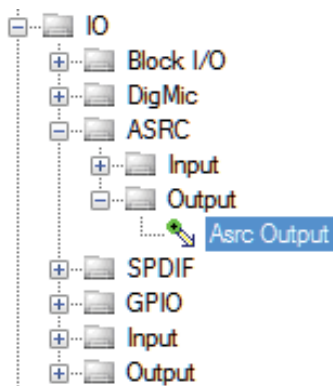

Figure 55. Location of DSP-to-ASRC Output Cell in SigmaStudio Toolbox

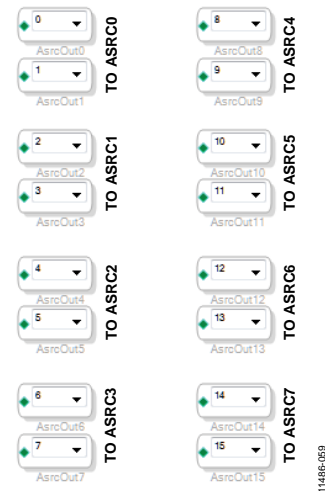

Figure 56. Routing of DSP-to-ASRC Output Cells in SigmaStudio to ASRC Inputs

The ASRCs can also be used to take asynchronous inputs and convert them to a different sample rate without doing any processing in the DSP core.

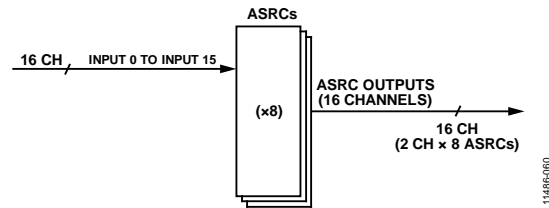

Figure 57. Example ASRC Routing, Bypassing DSP Core

Configure the ASRC routing registers using a simple graphical interface in the SigmaStudio software (see Figure 59).

**Asynchronous Sample Rate Converter Output Routing**

The outputs of the ASRCs are always available at both the DSP core and the serial outputs. No manual routing is necessary. To route ASRC output data to serial output channels, configure Register 0xF180 to Register 0xF197 (SOUT\_SOURCEx) accordingly. For more information, see Figure 58 and Table 43.

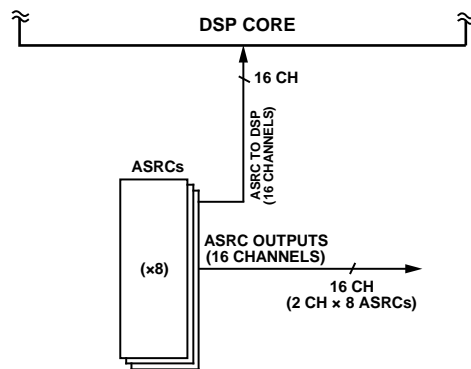

Figure 58. ASRC Outputs

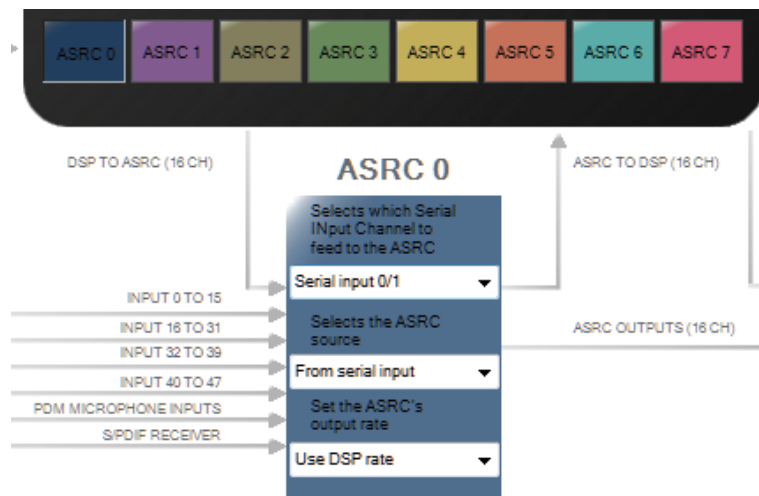

Figure 59. Configuring the ASRC Input Source and Target Rate in SigmaStudio

**Audio Signal Routing Registers**

An overview of the registers related to audio routing is listed in Table 43. For more detailed information, refer to the Audio Signal Routing Registers section.

**Table 43. Audio Routing Matrix Registers**

Address	Register	Description
0xF100	ASRC_INPUT0	ASRC input selector (ASRC 0, Channel 0 and Channel 1)
0xF101	ASRC_INPUT1	ASRC input selector (ASRC 1, Channel 2 and Channel 3)
0xF102	ASRC_INPUT2	ASRC input selector (ASRC 2, Channel 4 and Channel 5)
0xF103	ASRC_INPUT3	ASRC input selector (ASRC 3, Channel 6 and Channel 7)
0xF104	ASRC_INPUT4	ASRC input selector (ASRC 4, Channel 8 and Channel 9)
0xF105	ASRC_INPUT5	ASRC input selector (ASRC 5, Channel 10 and Channel 11)
0xF106	ASRC_INPUT6	ASRC input selector (ASRC 6, Channel 12 and Channel 13)
0xF107	ASRC_INPUT7	ASRC input selector (ASRC 7, Channel 14 and Channel 15)
0xF140	ASRC_OUT_RATE0	ASRC output rate (ASRC 0, Channel 0 and Channel 1)
0xF141	ASRC_OUT_RATE1	ASRC output rate (ASRC 1, Channel 2 and Channel 3)
0xF142	ASRC_OUT_RATE2	ASRC output rate (ASRC 2, Channel 4 and Channel 5)
0xF143	ASRC_OUT_RATE3	ASRC output rate (ASRC 3, Channel 6 and Channel 7)
0xF144	ASRC_OUT_RATE4	ASRC output rate (ASRC 4, Channel 8 and Channel 9)
0xF145	ASRC_OUT_RATE5	ASRC output rate (ASRC 5, Channel 10 and Channel 11)
0xF146	ASRC_OUT_RATE6	ASRC output rate (ASRC 6, Channel 12 and Channel 13)
0xF147	ASRC_OUT_RATE7	ASRC output rate (ASRC 7, Channel 14 and Channel 15)
0xF180	SOUT_SOURCE0	Source of data for serial output port (Channel 0 and Channel 1)
0xF181	SOUT_SOURCE1	Source of data for serial output port (Channel 2 and Channel 3)
0xF182	SOUT_SOURCE2	Source of data for serial output port (Channel 4 and Channel 5)
0xF183	SOUT_SOURCE3	Source of data for serial output port (Channel 6 and Channel 7)
0xF184	SOUT_SOURCE4	Source of data for serial output port (Channel 8 and Channel 9)
0xF185	SOUT_SOURCE5	Source of data for serial output port (Channel 10 and Channel 11)
0xF186	SOUT_SOURCE6	Source of data for serial output port (Channel 12 and Channel 13)
0xF187	SOUT_SOURCE7	Source of data for serial output port (Channel 14 and Channel 15)
0xF188	SOUT_SOURCE8	Source of data for serial output port (Channel 16 and Channel 17)
0xF189	SOUT_SOURCE9	Source of data for serial output port (Channel 18 and Channel 19)
0xF18A	SOUT_SOURCE10	Source of data for serial output port (Channel 20 and Channel 21)
0xF18B	SOUT_SOURCE11	Source of data for serial output port (Channel 22 and Channel 23)
0xF18C	SOUT_SOURCE12	Source of data for serial output port (Channel 24 and Channel 25)
0xF18D	SOUT_SOURCE13	Source of data for serial output port (Channel 26 and Channel 27)
0xF18E	SOUT_SOURCE14	Source of data for serial output port (Channel 28 and Channel 29)
0xF18F	SOUT_SOURCE15	Source of data for serial output port (Channel 30 and Channel 31)
0xF190	SOUT_SOURCE16	Source of data for serial output port (Channel 32 and Channel 33)
0xF191	SOUT_SOURCE17	Source of data for serial output port (Channel 34 and Channel 35)
0xF192	SOUT_SOURCE18	Source of data for serial output port (Channel 36 and Channel 37)
0xF193	SOUT_SOURCE19	Source of data for serial output port (Channel 38 and Channel 39)
0xF194	SOUT_SOURCE20	Source of data for serial output port (Channel 40 and Channel 41)
0xF195	SOUT_SOURCE21	Source of data for serial output port (Channel 42 and Channel 43)
0xF196	SOUT_SOURCE22	Source of data for serial output port (Channel 44 and Channel 45)
0xF197	SOUT_SOURCE23	Source of data for serial output port (Channel 46 and Channel 47)
0xF1C0	SPDIFTX_INPUT	S/PDIF transmitter data selector



**SERIAL DATA INPUT/OUTPUT**

There are four serial data input pins (SDATA\_IN3 to SDATA\_IN0) and four serial data output pins (SDATA\_OUT3 to SDATA\_OUT0). Each pin is capable of 2-channel, 4-channel, or 8-channel mode. In addition, SDATA\_IN0, SDATA\_IN1, SDATA\_OUT0, and SDATA\_OUT1 are capable of 16-channel mode.

The serial ports have a very flexible configuration scheme that allows for completely independent and orthogonal configuration of clock pin assignment, clock waveform type, clock polarity, channel count, position of the data bits within the stream, audio word length, slave or master operation, and sample rate. A detailed description of all possible serial port settings is included in the Serial Port Configuration Registers section.

The physical serial data input and output pins are connected to functional blocks called serial ports, which deal with handling the audio data and clocks as they pass in and out of the device. Table 44 describes this relationship.

**Table 44. Relationship Between Hardware Serial Data Pins and Serial Input/Output Ports**

Serial Data Pin	Serial Port
SDATA_IN0	Serial Input Port 0
SDATA_IN1	Serial Input Port 1
SDATA_IN2	Serial Input Port 2
SDATA_IN3	Serial Input Port 3
SDATA_OUT0	Serial Output Port 0
SDATA_OUT1	Serial Output Port 1
SDATA_OUT2	Serial Output Port 2
SDATA_OUT3	Serial Output Port 3

There are 48 channels of serial audio data inputs and 48 channels of serial audio data outputs. The 48 audio input channels and 48 audio output channels are distributed among the four serial data input pins and the four serial data output pins. This distribution is described in Table 45.

The maximum sample rate for the serial audio data on the serial ports is 192 kHz. The minimum sample rate is 6 kHz.

SDATA\_IN2, SDATA\_IN3, SDATA\_OUT2, and SDATA\_OUT3 are capable of operating in a special mode called flexible TDM mode, which allows for custom byte addressable configuration, where the data for each channel is located in the serial data stream. Flexible TDM mode is not a standard audio interface. Use it only in cases where a customized serial data format is desired. See the Flexible TDM Interface section for more information.

**Serial Audio Data Format**

The serial data input and output ports are designed to work with audio data that is encoded in a linear pulse code modulation (PCM) format, based on the common I<sup>2</sup>S standard. Audio data-words can be 16, 24, or 32 bits in length. The serial ports can handle TDM formats with channel counts ranging from two channels to 16 channels on a single data line.

Almost every aspect of the serial audio data format can be configured using the SERIAL\_BYTE\_x\_0 and SERIAL\_BYTE\_x\_1 registers, and every setting can be configured independently. As a result, there are more than 70,000 valid configurations for each serial audio port.

**Serial Audio Data Timing Diagrams**

Because it is impractical to show timing diagrams for each possible combination, timing diagrams for the more common configurations are shown in Figure 60 to Figure 65. Explanatory text accompanies each figure.

**Table 45. Relationship Between Data Pin, Audio Channels, Clock Pins, and TDM Options**

Serial Data Pin	Channel Numbering	Corresponding Clock Pins in Master Mode	Maximum TDM Channels	Flexible TDM Mode
SDATA_IN0	Channel 0 to Channel 15	BCLK_IN0, LRCLK_IN0	16 channels	No
SDATA_IN1	Channel 16 to Channel 31	BCLK_IN1, LRCLK_IN1	16 channels	No
SDATA_IN2	Channel 32 to Channel 39	BCLK_IN2, LRCLK_IN2	8 channels	Yes
SDATA_IN3	Channel 40 to Channel 47	BCLK_IN3, LRCLK_IN3	8 channels	Yes
SDATA_OUT0	Channel 0 to Channel 15	BCLK_OUT0, LRCLK_OUT0	16 channels	No
SDATA_OUT1	Channel 16 to Channel 31	BCLK_OUT1, LRCLK_OUT1	16 channels	No
SDATA_OUT2	Channel 32 to Channel 39	BCLK_OUT2, LRCLK_OUT2	8 channels	Yes
SDATA_OUT3	Channel 40 to Channel 47	BCLK_OUT3, LRCLK_OUT3	8 channels	Yes

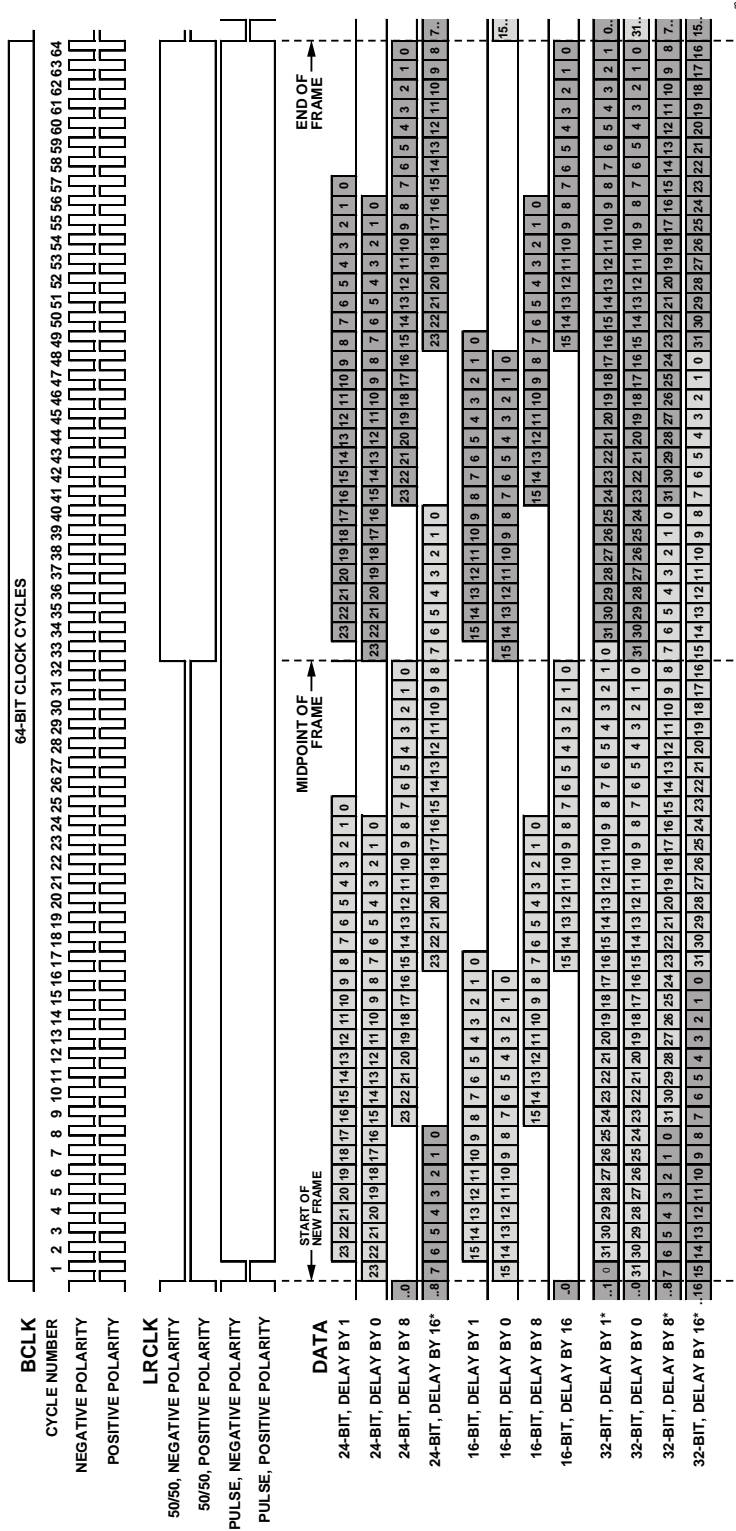

\*IT IS POSSIBLE FOR THE USER TO CONFIGURE THE SERIAL PORTS TO OPERATE IN THIS MODE. HOWEVER, IT IS RECOMMENDED THAT THIS MODE NOT BE USED BECAUSE THE AUDIO DATA CROSSES THE THRESHOLD BETWEEN TWO FRAMES, WHICH MAY VIOLATE THE SPECIFICATIONS OF OTHER DEVICES IN THE SYSTEM.

Figure 60. Serial Audio Formats; Two Channels, 32 Bits per Channel

Figure 60 shows timing diagrams for possible serial port configurations in 2-channel mode, with 32 cycles of the bit clock signal per channel, for a total of 64 bit clock cycles per frame (see the SERIAL\_BYTE\_x\_0 registers, Bits[2:0] (TDM\_MODE) = 0b000). Different bit clock polarities are illustrated in Figure 60 (SERIAL\_BYTE\_x\_0, Bit 7 (BCLK\_POL)) as well as different

frame clock waveforms and polarities (SERIAL\_BYTE\_x\_0, Bit 9 (LRCLK\_MODE) and Bit 8 (LRCLK\_POL)). Excluding flexible TDM mode, there are 12 possible combinations of settings for the audio word length (SERIAL\_BYTE\_x\_0, Bits[6:5] (WORD\_LEN)) and MSB position (SERIAL\_BYTE\_x\_0, Bits[4:3] (DATA\_FMT)), all of which are shown in Figure 60.

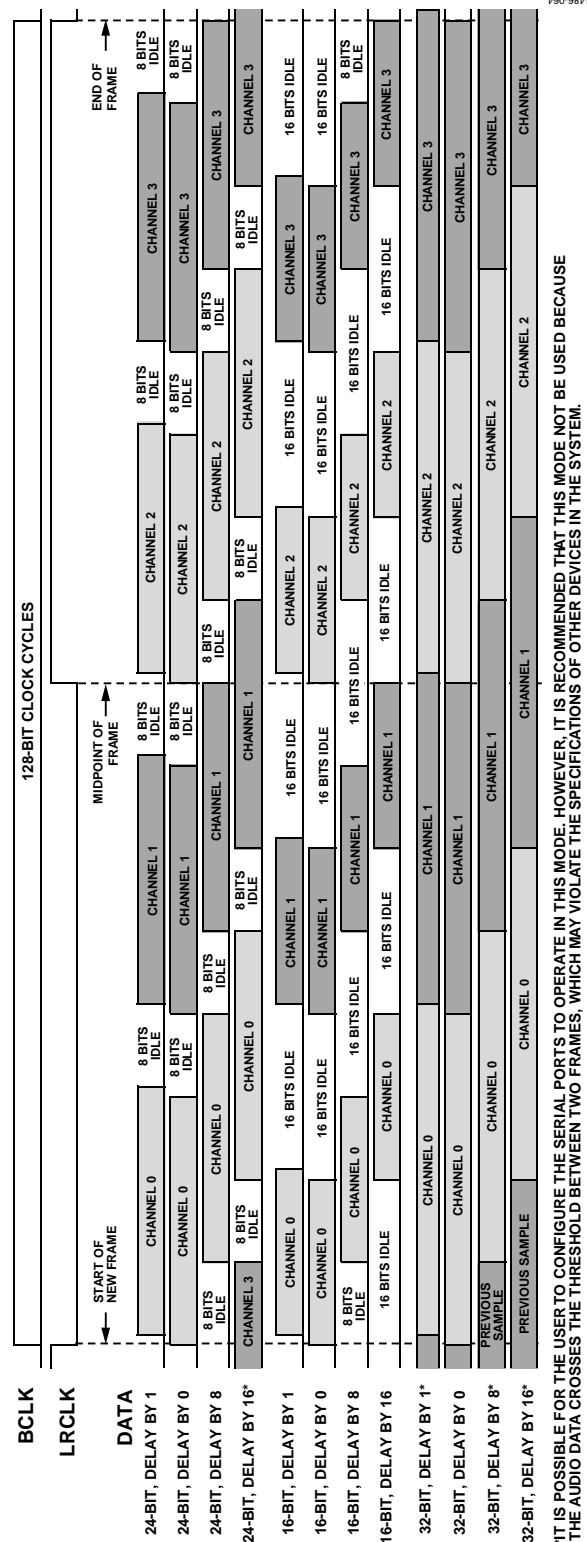
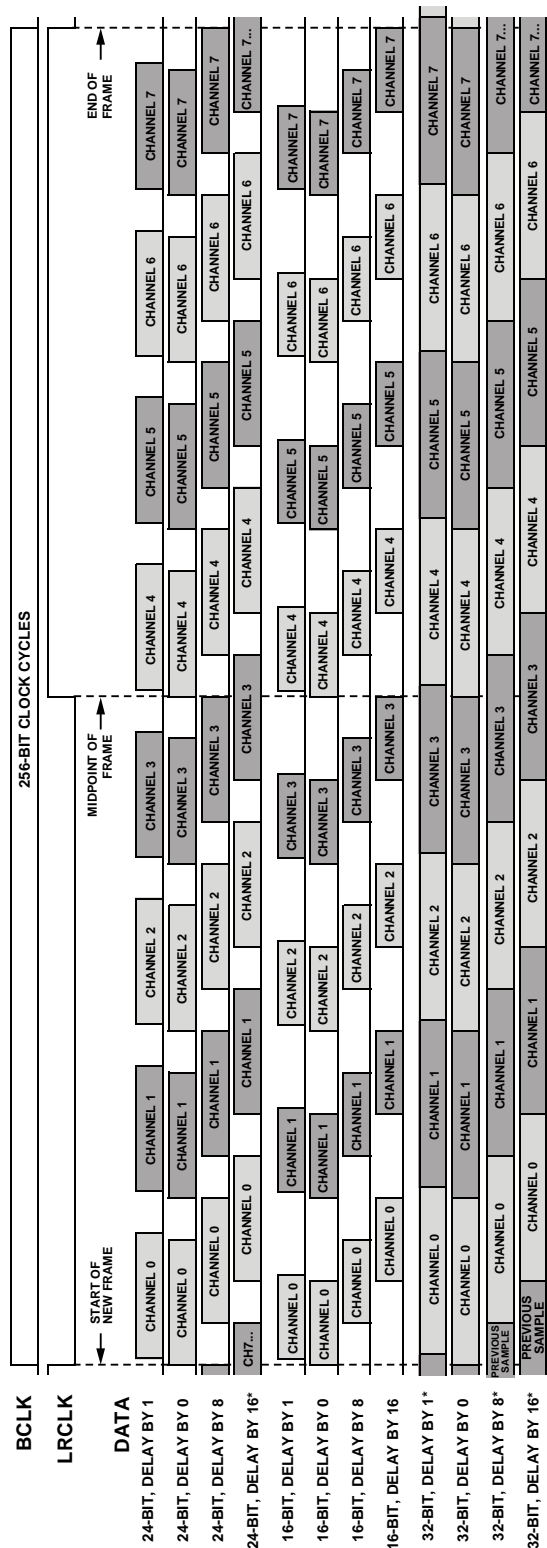

Figure 61. Serial Audio Data Formats; Four Channels, 32 Bits per Channel

Figure 61 shows timing diagrams for possible serial port configurations in 4-channel mode, with 32 bit clock cycles per channel, for a total of 128 bit clock cycles per frame (refer to the SERIAL\_BYTE\_x\_0 registers, Bits[2:0] (TDM\_MODE) = 0b001). The bit clock signal is omitted from the figure.

Excluding flexible TDM mode, there are 12 possible combinations of settings for the audio word length (SERIAL\_BYTE\_x\_0, Bits[6:5] (WORD\_LEN)) and MSB position (SERIAL\_BYTE\_x\_0, Bits[4:3] (DATA\_FMT)), all of which are shown in Figure 61.



11486-050  
 \*IT IS POSSIBLE FOR THE USER TO CONFIGURE THE SERIAL PORTS TO OPERATE IN THIS MODE. HOWEVER, IT IS RECOMMENDED THAT THIS MODE NOT BE USED BECAUSE THE AUDIO DATA CROSSES THE THRESHOLD BETWEEN TWO FRAMES, WHICH MAY VIOLATE THE SPECIFICATIONS OF OTHER DEVICES IN THE SYSTEM.

Figure 62. Serial Audio Data Formats; Eight Channels, 32 Bits per Channel

Figure 62 shows timing diagrams for possible serial port configurations in 8-channel mode, with 32 bit clock cycles per channel, for a total of 256 bit clock cycles per frame (refer to the SERIAL\_BYTE\_x\_0 registers, Bits[2:0] (TDM\_MODE) = 0b010). The bit clock signal is omitted from the figure.

Excluding flexible TDM mode, there are 12 possible combinations of settings for the audio word length (SERIAL\_BYTE\_x\_0, Bits[6:5] (WORD\_LEN)) and MSB position (SERIAL\_BYTE\_x\_0, Bits[4:3] (DATA\_FMT)), all of which are shown in Figure 62.

990-987-11

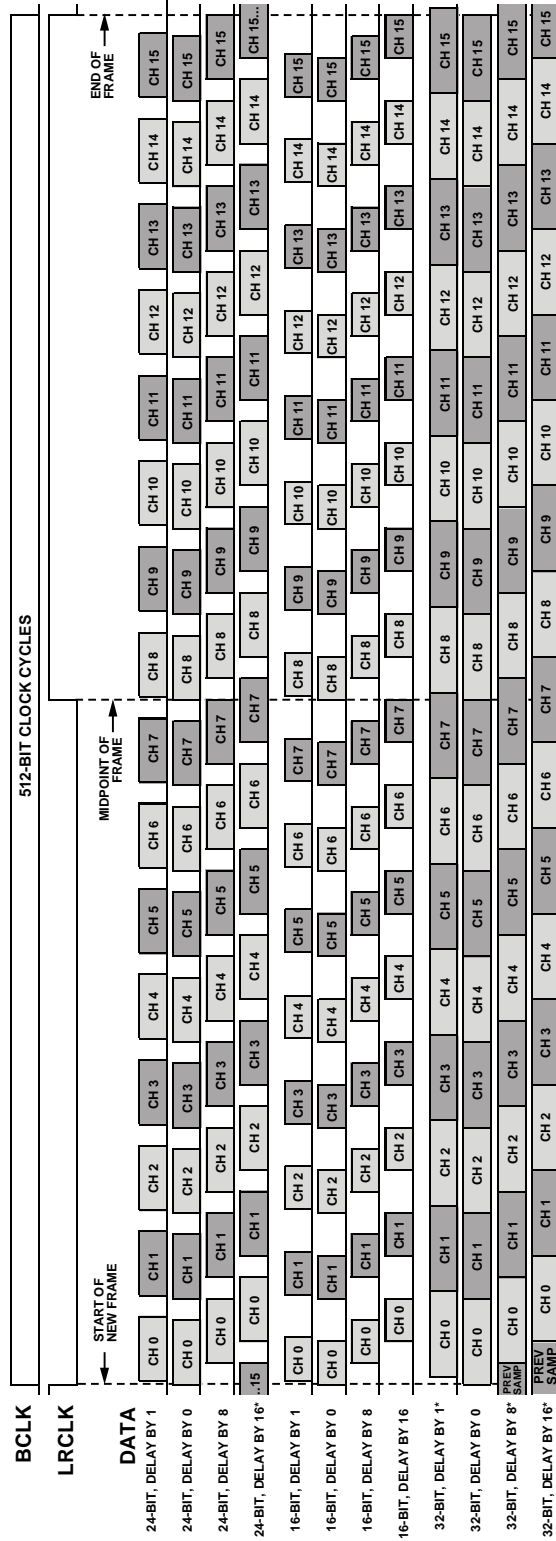

Figure 63. Serial Audio Data Formats; 16 Channels, 32 Bits per Channel

Figure 63 shows some timing diagrams for possible serial port configurations in 16-channel mode, with 32 bit clock cycles per channel, for a total of 512 bit clock cycles per frame (refer to the SERIAL\_BYTE\_x\_0 registers, Bits[2:0] (TDM\_MODE) = 0b011). The bit clock signal is omitted from the figure.

Excluding flexible TDM mode, there are 12 possible combinations of settings for the audio word length (SERIAL\_BYTE\_x\_0, Bits[6:5] (WORD\_LEN)) and MSB position (SERIAL\_BYTE\_x\_0, Bits[4:3] (DATA\_FMT)), all of which are shown in Figure 63.

\*IT IS POSSIBLE FOR THE USER TO CONFIGURE THE SERIAL PORTS TO OPERATE IN THIS MODE. HOWEVER, IT IS RECOMMENDED THAT THIS MODE NOT BE USED BECAUSE THE AUDIO DATA CROSSES THE THRESHOLD BETWEEN TWO FRAMES, WHICH MAY VIOLATE THE SPECIFICATIONS OF OTHER DEVICES IN THE SYSTEM.

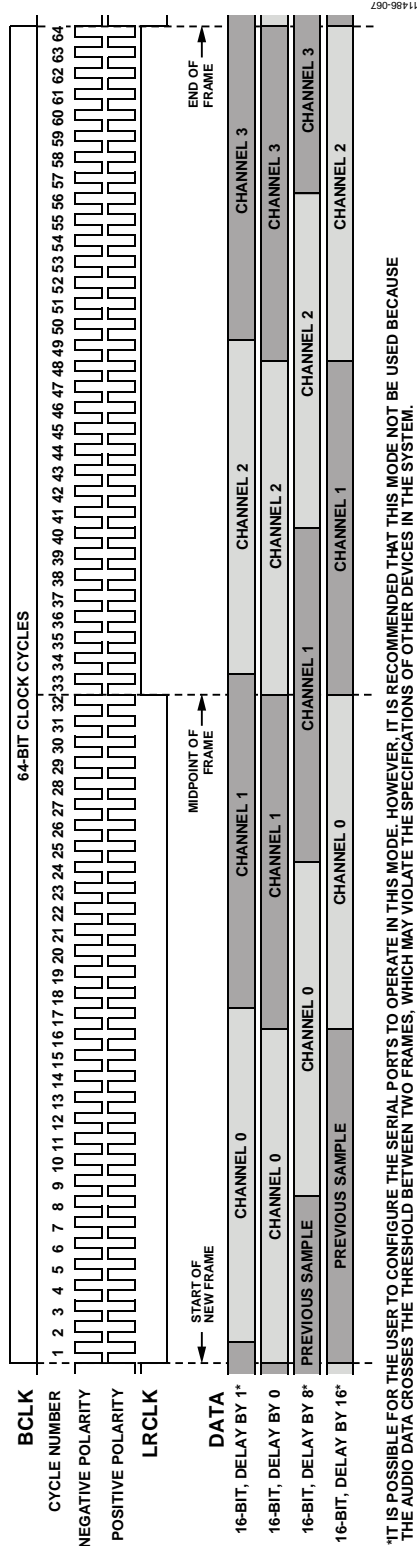
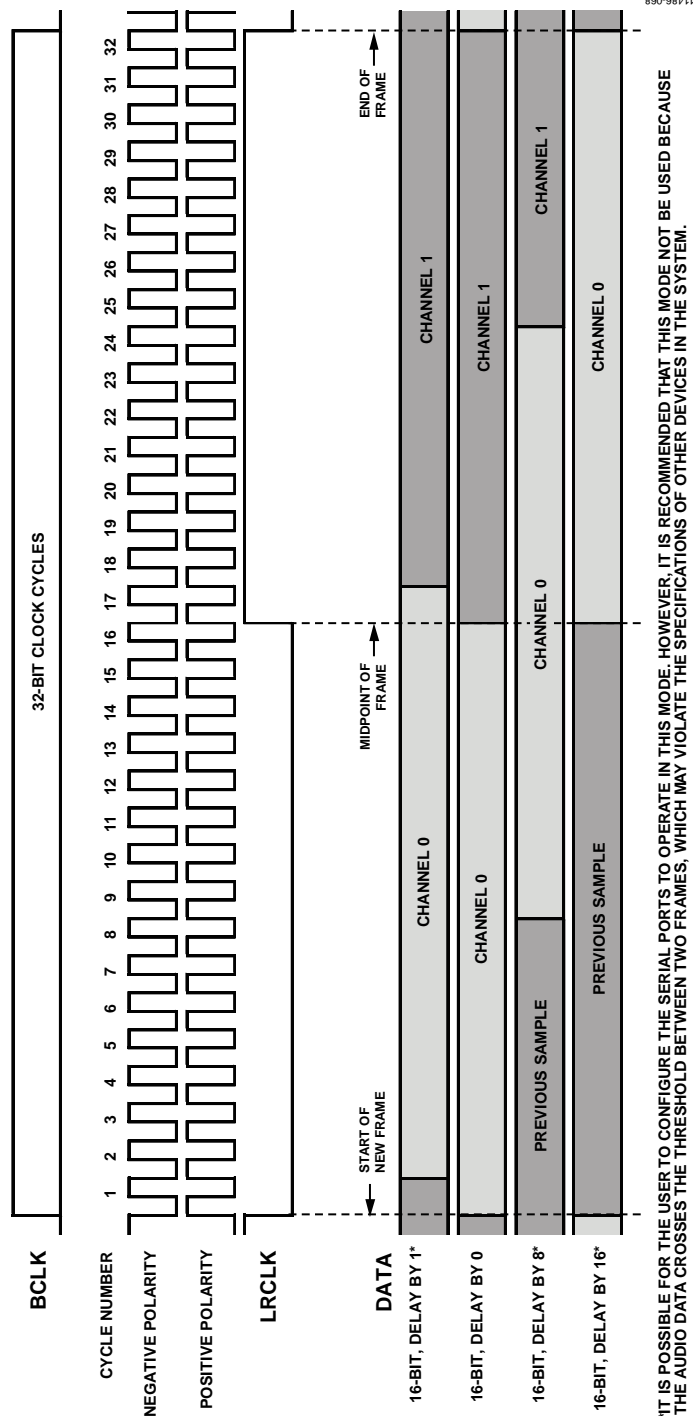

Figure 64. Serial Audio Data Formats; Four Channels, 16 Bits per Channel

Figure 64 shows some timing diagrams for possible serial port configurations in 4-channel mode, with 16 bit clock cycles per channel, for a total of 64 bit clock cycles per frame (refer to the SERIAL\_BYTE\_x\_0 registers, Bits[2:0] (TDM\_MODE) = 0b100). Different bit clock polarities are shown (refer to the SERIAL\_

BYTE\_x\_0 registers, Bit 7 (BCLK\_POL)). The audio word length is fixed at 16 bits (refer to the SERIAL\_BYTE\_x\_0 registers, Bits[6:5] (WORD\_LEN) = 0b01), and there are four possible configurations for MSB position (SERIAL\_BYTE\_x\_0, Bits[4:3] (DATA\_FMT)), all of which are shown in Figure 64.



1496-0611

Figure 65. Serial Audio Data Formats; Two Channels, 16 Bits per Channel

Figure 65 shows some timing diagrams for possible serial port configurations in two channel mode, with 16 bit clock cycles per channel, for a total of 32 bit clock cycles per frame (refer to the SERIAL\_BYTE\_x\_0 registers, Register 0xF200 to Register 0xF21C, Bits[2:0] (TDM\_MODE) = 0b101).

Different bit clock polarities are illustrated (SERIAL\_BYTE\_x\_0, Bit 7 (BCLK\_POL)). The audio word length is fixed at 16 bits (SERIAL\_BYTE\_x\_0, Bits[6:5] (WORD\_LEN) = 0b01), and there are four possible configurations for MSB position (SERIAL\_BYTE\_x\_0, Bits[4:3] (DATA\_FMT)), all of which are shown in Figure 65.

**Serial Clock Domains**

There are four input clock domains and four output clock domains. A clock domain consists of a pair of LRCLK\_OUTx and LRCLK\_INx (frame clock) and BCLK\_OUTx and BCLK\_INx (bit clock) pins, which are used to synchronize the transmission of audio data to and from the device. There are eight total clock domains. Four of them are input domains and four of them are output domains. In master mode (refer to the SERIAL\_BYTE\_x\_0 registers, Register 0xF200 to Register 0xF21C, Bits[15:13] (LRCLK\_SRC) = 0b100 and Bits[12:10] (BCLK\_SRC) = 0b100), each clock domain corresponds to exactly one serial data pin, one frame clock

pin, and one bit clock pin. Any serial data input can be clocked by any input clock domains when it is configured in slave mode (refer to the SERIAL\_BYTE\_x\_0 registers, Bits[15:13] (LRCLK\_SRC), which can be set to 0b000, 0b001, 0b010, or 0b011; and Bits[12:10] (BCLK\_SRC), which can be set to 0b000, 0b001, 0b010, or 0b011). Any serial data output can be clocked by any output clock domain when it is configured in slave mode (see the SERIAL\_BYTE\_x\_0 registers, Bits[15:13] (LRCLK\_SRC), which can be set to 0b000, 0b001, 0b010, or 0b011; and Bits[12:10] (BCLK\_SRC), which can be set to 0b000, 0b001, 0b010, or 0b011).

**Table 46. Relationship Between Serial Data Pins and Clock Pins in Master or Slave Mode**

Serial Data Pin	Corresponding Clock Pins in Master Mode	Corresponding Clock Pins in Slave Mode
SDATA_IN0	BCLK_IN0, LRCLK_IN0 (LRCLK_IN0/MP10)	BCLK_IN0, LRCLK_IN0 or BCLK_IN1, LRCLK_IN1 or BCLK_IN2, LRCLK_IN2 or BCLK_IN3, LRCLK_IN3
SDATA_IN1	BCLK_IN1, LRCLK_IN1 (LRCLK_IN1/MP11)	BCLK_IN0, LRCLK_IN0 or BCLK_IN1, LRCLK_IN1 or BCLK_IN2, LRCLK_IN2 or BCLK_IN3, LRCLK_IN3
SDATA_IN2	BCLK_IN2, LRCLK_IN2 (LRCLK_IN2/MP12)	BCLK_IN0, LRCLK_IN0 or BCLK_IN1, LRCLK_IN1 or BCLK_IN2, LRCLK_IN2 or BCLK_IN3, LRCLK_IN3
SDATA_IN3	BCLK_IN3, LRCLK_IN3 (LRCLK_IN3/MP13)	BCLK_IN0, LRCLK_IN0 or BCLK_IN1, LRCLK_IN1 or BCLK_IN2, LRCLK_IN2 or BCLK_IN3, LRCLK_IN3
SDATA_OUT0	BCLK_OUT0, LRCLK_OUT0 (LRCLK_OUT0/MP4)	BCLK_OUT0, LRCLK_OUT0 or BCLK_OUT1, LRCLK_OUT1 or BCLK_OUT2, LRCLK_OUT2 or BCLK_OUT3, LRCLK_OUT3
SDATA_OUT1	BCLK_OUT1, LRCLK_OUT1 (LRCLK_OUT1/MP5)	BCLK_OUT0, LRCLK_OUT0 or BCLK_OUT1, LRCLK_OUT1 or BCLK_OUT2, LRCLK_OUT2 or BCLK_OUT3, LRCLK_OUT3
SDATA_OUT2	BCLK_OUT2, LRCLK_OUT2 (LRCLK_OUT2/MP8)	BCLK_OUT0, LRCLK_OUT0 or BCLK_OUT1, LRCLK_OUT1 or BCLK_OUT2, LRCLK_OUT2 or BCLK_OUT3, LRCLK_OUT3
SDATA_OUT3	BCLK_OUT3, LRCLK_OUT3 (LRCLK_OUT3/MP9)	BCLK_OUT0, LRCLK_OUT0 or BCLK_OUT1, LRCLK_OUT1 or BCLK_OUT2, LRCLK_OUT2 or BCLK_OUT3, LRCLK_OUT3



**Serial Input Ports**

There is a one-to-one mapping between the serial input ports and the audio input channels in the DSP and the ASRC input selectors, which is described in Table 47.

**Table 47. Relationship Between Serial Input Port and Corresponding Channel Numbers on the DSP and ASRC Inputs**

Serial Port	Audio Input Channels in the DSP and ASRC
Serial Input 0	0, 1, 2, 3, 4, 5, 6, 7, 8, 9, 10, 11, 12, 13, 14, 15
Serial Input 1	16, 17, 18, 19, 20, 21, 22, 23, 24, 25, 26, 27, 28, 29, 30, 31
Serial Input 2	32, 33, 34, 35, 36, 37, 38, 39
Serial Input 3	40, 41, 42, 43, 44, 45, 46, 47

If a serial input port is configured using the SERIAL\_BYTE\_x\_0 registers, Bits[2:0] (TDM\_MODE) for a number of channels that is less than its maximum channel count, the unused channels carry zero data. For example, if Serial Input 0 is set in 8-channel (TDM8) mode, the first eight channels (Channel 0 to Channel 7) carry data; and the unused channels (Channel 8 to Channel 15) carry no data.

There are four options for the word length of each serial input port: 24 bits, 16 bits, 32 bits, or flexible TDM. The flexible TDM option is described in the Flexible TDM Input section.

In 32-bit mode (see Figure 66), the 32 bits received on the serial input are mapped directly to a 32-bit word in the DSP core. To use 32-bit mode, the special 32-bit input cells must be used in SigmaStudio.

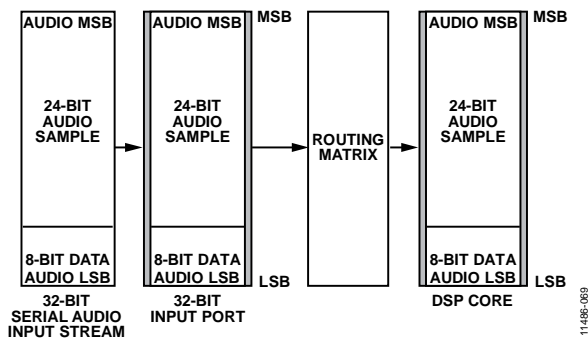

Figure 66. 32-Bit Serial Input Example

In 24-bit mode (see Figure 68), the 24-bit audio sample (in 1.23 format) is padded with eight zeros below its LSB (in 1.31 format) as it is input to the routing matrix. Then, the audio data is shifted such that the audio sample has seven sign-extended zeros on top, one padded zero on the bottom, and 24 bits of data in the middle (8.24 format).

Whereas 16-bit mode is similar to 24-bit mode, the 16-bit audio data has 16 zeros below its LSB instead of just eight zeros (in the 24-bit case). The resulting 8.24 sample, therefore, has seven sign-extended zeros on top, nine padded zeros on the bottom, and 16 bits of data in the middle (8.24 format).

**Serial Output Ports**

There is a one-to-one mapping between the serial output ports and the output audio channels in the DSP (see Table 48).

**Table 48. Relationship Between Serial Input Port and Corresponding DSP Output Channel Numbers**

Serial Input Port	Audio Output Channels from the DSP
Serial Output 0	0, 1, 2, 3, 4, 5, 6, 7, 8, 9, 10, 11, 12, 13, 14, 15
Serial Output 1	16, 17, 18, 19, 20, 21, 22, 23, 24, 25, 26, 27, 28, 29, 30, 31
Serial Output 2	32, 33, 34, 35, 36, 37, 38, 39
Serial Output 3	40, 41, 42, 43, 44, 45, 46, 47

If a serial output port is configured using the SERIAL\_BYTE\_x\_0 registers, Bits[2:0] (TDM\_MODE), for a number of channels that is less than its maximum channel count, the unused channels are ignored. For example, if Serial Output Port 0 is set in 8-channel (TDM8) mode, and data is routed to it from the DSP, the first eight DSP output channels (Channel 0 through Channel 7) are output on SDATA\_OUT0, but the remaining channels (Channel 8 through Channel 15) are not output from the device.

There are four options for the word length of each serial output port: 24 bits, 16 bits, 32 bits, or flexible TDM. See the Flexible TDM Output section for more information.

In 32-bit mode (see Figure 67), all 32 bits from the 8.24 word in the DSP core are copied directly to the serial output. To use 32-bit mode, the special 32-bit output cells must be used in SigmaStudio.

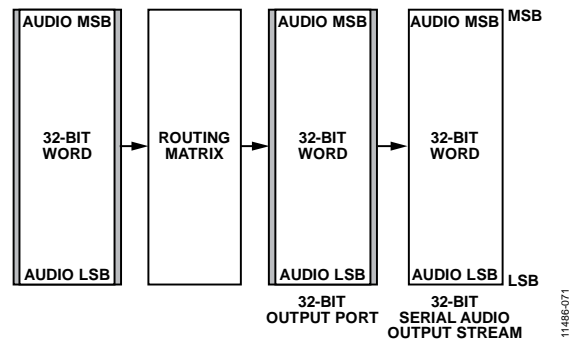

Figure 67. 32-Bit Serial Output Example

In 24-bit mode, the top seven MSBs of the 8.24 audio word in the DSP core are saturated, and the resulting 1.23 word is output from the serial port, with eight zeros padded under the LSB (see Figure 69).

In 16-bit mode, the top seven MSBs of the 8.24 audio word in the DSP core are saturated, and the resulting 1.23 word is then truncated to a 1.15 word by removing the eight LSBs. The resulting 1.15 word is then zero padded with 16 zeros under the LSB and output from the serial port.

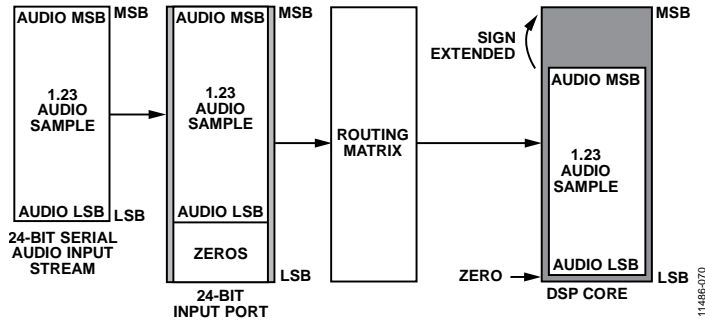

Figure 68. 24-Bit Serial Input Example

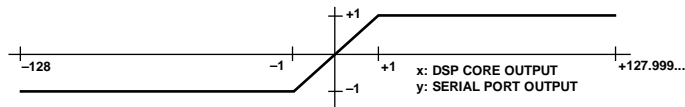

Figure 69. 24-Bit Serial Output Example

**Serial Port Registers**

An overview of the registers related to the serial ports is shown in Table 49. For a more detailed description, see the Serial Port Configuration Registers section.

**Table 49. Serial Port Registers**

Address	Register	Description
0xF200	SERIAL_BYTE_0_0	Serial Port Control 0 (SDATA_IN0 pin)
0xF201	SERIAL_BYTE_0_1	Serial Port Control 1 (SDATA_IN0 pin)
0xF204	SERIAL_BYTE_1_0	Serial Port Control 0 (SDATA_IN1 pin)
0xF205	SERIAL_BYTE_1_1	Serial Port Control 1 (SDATA_IN1 pin)
0xF208	SERIAL_BYTE_2_0	Serial Port Control 0 (SDATA_IN2 pin)
0xF209	SERIAL_BYTE_2_1	Serial Port Control 1 (SDATA_IN2 pin)
0xF20C	SERIAL_BYTE_3_0	Serial Port Control 0 (SDATA_IN3 pin)
0xF20D	SERIAL_BYTE_3_1	Serial Port Control 1 (SDATA_IN3 pin)
0xF210	SERIAL_BYTE_4_0	Serial Port Control 0 (SDATA_OUT0 pin)
0xF211	SERIAL_BYTE_4_1	Serial Port Control 1 (SDATA_OUT0 pin)
0xF214	SERIAL_BYTE_5_0	Serial Port Control 0 (SDATA_OUT1 pin)
0xF215	SERIAL_BYTE_5_1	Serial Port Control 1 (SDATA_OUT1 pin)
0xF218	SERIAL_BYTE_6_0	Serial Port Control 0 (SDATA_OUT2 pin)
0xF219	SERIAL_BYTE_6_1	Serial Port Control 1 (SDATA_OUT2 pin)
0xF21C	SERIAL_BYTE_7_0	Serial Port Control 0 (SDATA_OUT3 pin)
0xF21D	SERIAL_BYTE_7_1	Serial Port Control 1 (SDATA_OUT3 pin)

## FLEXIBLE TDM INTERFACE

The flexible TDM interface is available as an optional mode of operation on the SDATA\_IN2 and SDATA\_IN3 serial input ports, as well as on the SDATA\_OUT2 and SDATA\_OUT3 serial output ports. To use flexible TDM mode, the corresponding serial ports must be set in flexible TDM mode (SERIAL\_BYTE\_x\_0 register, Bits[6:5] (WORD\_LEN) = 0b11 and SERIAL\_BYTE\_x\_0 register, Bits[2:0] = 0b010). Flexible TDM input mode requires that both SDATA\_IN2 and SDATA\_IN3 be configured for flexible TDM mode. Likewise, flexible TDM output mode requires that both SDATA\_OUT2 and SDATA\_OUT3 pins be configured for flexible TDM mode.

The flexible TDM interface provides byte addressable data placement in the input and output data streams on the corresponding serial data input/output pins. Each data stream is configured like a standard 8-channel TDM interface, with a total of 256 data bits (or 32 bytes) in the span of an audio frame. Because flexible TDM mode runs on two pins simultaneously, and each pin has 32 bytes of data, this means that there are a total of 64 data bytes. In flexible TDM input mode, each input channel inside the device can select its source data from any of the 64 input data bytes. In flexible TDM output mode, any serial output channel can be routed to any of the 64 output data bytes.

### **Flexible TDM Input**

In flexible TDM input mode, two 256-bit data streams are input to the SDATA\_IN2 and SDATA\_IN3 pins. These 256 bits of data compose eight channels of four bytes each, for a total of 32 bytes on each pin, and a total of 64 bytes when both input pins are combined. The flexible TDM input functional block routes the desired input byte to a given byte in the serial input channels. Those serial input channels are then available as normal audio data in the audio routing matrix. The data can be passed to the DSP core, the ASRC inputs, or the serial outputs as needed.

There are a total of 64 control registers (FTDM\_INx) that can be configured to set up the mapping of input data bytes to the corresponding bytes in the serial input channels. Each byte in each serial input channel has a corresponding control register, which selects the incoming data byte on the serial input pins that must be mapped to it. Figure 70 shows, from left to right, the data streams entering the serial input pins, the serial input channels, and the registers (see FTDM\_INx, Register 0xF300 to Register 0xF33F) that correspond to each byte in the serial input channels.

### **Flexible TDM Output**

In flexible TDM output mode, two 256-bit data streams are output from the SDATA\_OUT2 and SDATA\_OUT3 pins. These 256 bits of data compose eight channels of four bytes each, for a total of 32 bytes on each pin, and a total of 64 bytes when both input pins are combined. The flexible TDM output functional block routes the desired byte from the desired serial output channel to a given byte in the output streams. The serial output channels originate from the audio routing matrix, which is configured using the SOUT\_SOURCEx control registers.

There are a total of 64 control registers (see FTDM\_OUTx, Register 0xF3880 to Register 0xF3BF) that can be configured to set up the mapping of the bytes in the serial output channels and the bytes in the data streams exiting the serial output pins. Each byte in the data streams being output from the serial output pins has a corresponding control register, which selects the desired byte from the desired serial output channel. Figure 71 shows, from left to right, the serial output channels originating from the routing matrix, the serial output pins and data streams, and the control registers (FTDM\_OUTx) that correspond to each byte in the serial output data streams.

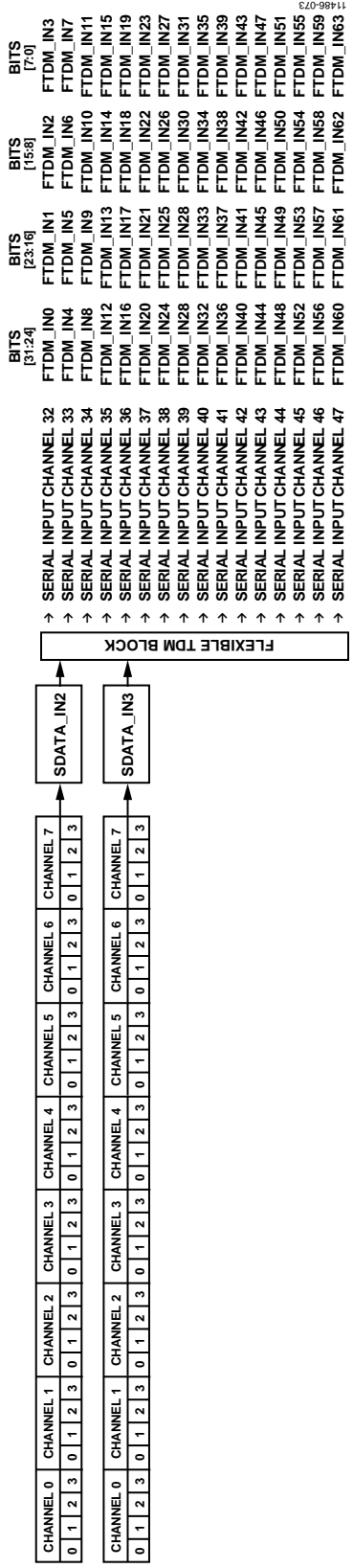

Figure 70. Flexible TDM Input Mapping

1486-073

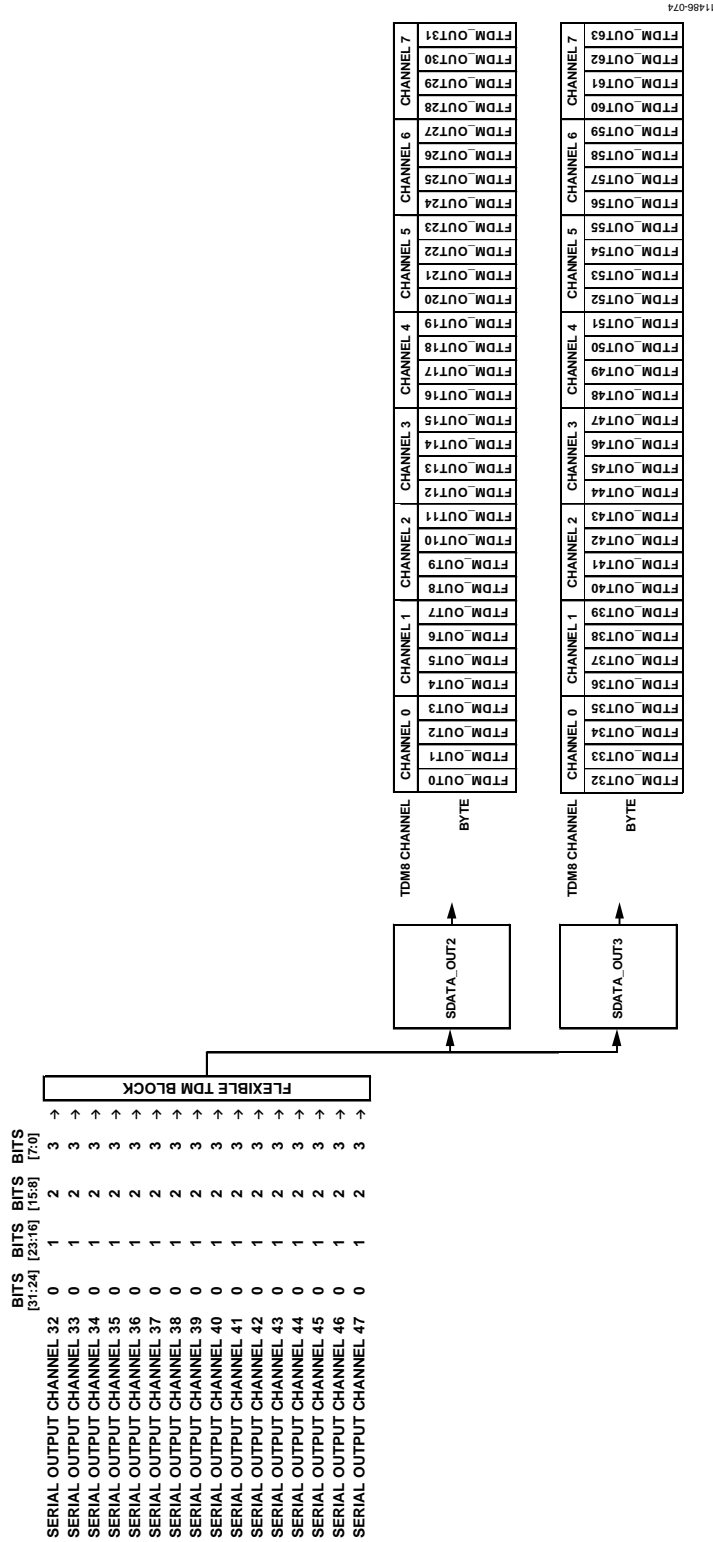

Figure 71. Flexible TDM Output Mapping

**Flexible TDM Registers**

An overview of the registers related to the flexible TDM interface is shown in Table 50. For a more detailed description, see the Flexible TDM Interface Registers section.

**Table 50. Flexible TDM Registers**

Address	Register	Description
0xF300	FTDM_IN0	FTDM mapping for the serial inputs (Channel 32, Bits[31:24])
0xF301	FTDM_IN1	FTDM mapping for the serial inputs (Channel 32, Bits[23:16])
0xF302	FTDM_IN2	FTDM mapping for the serial inputs (Channel 32, Bits[15:8])
0xF303	FTDM_IN3	FTDM mapping for the serial inputs (Channel 32, Bits[7:0])
0xF304	FTDM_IN4	FTDM mapping for the serial inputs (Channel 33, Bits[31:24])
0xF305	FTDM_IN5	FTDM mapping for the serial inputs (Channel 33, Bits[23:16])
0xF306	FTDM_IN6	FTDM mapping for the serial inputs (Channel 33, Bits[15:8])
0xF307	FTDM_IN7	FTDM mapping for the serial inputs Channel 33, Bits[7:0])
0xF308	FTDM_IN8	FTDM mapping for the serial inputs (Channel 34, Bits[31:24])
0xF309	FTDM_IN9	FTDM mapping for the serial inputs (Channel 34, Bits[23:16])
0xF30A	FTDM_IN10	FTDM mapping for the serial inputs (Channel 34, Bits[15:8])
0xF30B	FTDM_IN11	FTDM mapping for the serial inputs (Channel 34, Bits[7:0])
0xF30C	FTDM_IN12	FTDM mapping for the serial inputs (Channel 35, Bits[31:24])
0xF30D	FTDM_IN13	FTDM mapping for the serial inputs (Channel 35, Bits[23:16])
0xF30E	FTDM_IN14	FTDM mapping for the serial inputs (Channel 35, Bits[15:8])
0xF30F	FTDM_IN15	FTDM mapping for the serial inputs (Channel 35, Bits[7:0])
0xF310	FTDM_IN16	FTDM mapping for the serial inputs (Channel 36, Bits[31:24])
0xF311	FTDM_IN17	FTDM mapping for the serial inputs (Channel 36, Bits[23:16])
0xF312	FTDM_IN18	FTDM mapping for the serial inputs (Channel 36, Bits[15:8])
0xF313	FTDM_IN19	FTDM mapping for the serial inputs (Channel 36, Bits[7:0])
0xF314	FTDM_IN20	FTDM mapping for the serial inputs (Channel 37, Bits[31:24])
0xF315	FTDM_IN21	FTDM mapping for the serial inputs (Channel 37, Bits[23:16])
0xF316	FTDM_IN22	FTDM mapping for the serial inputs (Channel 37, Bits[15:8])
0xF317	FTDM_IN23	FTDM mapping for the serial inputs (Channel 37, Bits[7:0])
0xF318	FTDM_IN24	FTDM mapping for the serial inputs (Channel 38, Bits[31:24])
0xF319	FTDM_IN25	FTDM mapping for the serial inputs (Channel 38, Bits[23:16])
0xF31A	FTDM_IN26	FTDM mapping for the serial inputs (Channel 38, Bits[15:8])
0xF31B	FTDM_IN27	FTDM mapping for the serial inputs (Channel 38, Bits[7:0])
0xF31C	FTDM_IN28	FTDM mapping for the serial inputs (Channel 39, Bits[31:24])
0xF31D	FTDM_IN29	FTDM mapping for the serial inputs (Channel 39, Bits[23:16])
0xF31E	FTDM_IN30	FTDM mapping for the serial inputs (Channel 39, Bits[15:8])
0xF31F	FTDM_IN31	FTDM mapping for the serial inputs (Channel 39, Bits[7:0])
0xF320	FTDM_IN32	FTDM mapping for the serial inputs (Channel 40, Bits[31:24])
0xF321	FTDM_IN33	FTDM mapping for the serial inputs (Channel 40, Bits[23:16])
0xF322	FTDM_IN34	FTDM mapping for the serial inputs (Channel 40, Bits[15:8])
0xF323	FTDM_IN35	FTDM mapping for the serial inputs (Channel 40, Bits[7:0])
0xF324	FTDM_IN36	FTDM mapping for the serial inputs (Channel 41, Bits[31:24])
0xF325	FTDM_IN37	FTDM mapping for the serial inputs (Channel 41, Bits[23:16])
0xF326	FTDM_IN38	FTDM mapping for the serial inputs (Channel 41, Bits[15:8])
0xF327	FTDM_IN39	FTDM mapping for the serial inputs (Channel 41, Bits[7:0])
0xF328	FTDM_IN40	FTDM mapping for the serial inputs (Channel 42, Bits[31:24])
0xF329	FTDM_IN41	FTDM mapping for the serial inputs (Channel 42, Bits[23:16])
0xF32A	FTDM_IN42	FTDM mapping for the serial inputs (Channel 42, Bits[15:8])
0xF32B	FTDM_IN43	FTDM mapping for the serial inputs (Channel 42, Bits[7:0])
0xF32C	FTDM_IN44	FTDM mapping for the serial inputs (Channel 43, Bits[31:24])
0xF32D	FTDM_IN45	FTDM mapping for the serial inputs (Channel 43, Bits[23:16])
0xF32E	FTDM_IN46	FTDM mapping for the serial inputs (Channel 43, Bits[15:8])
0xF32F	FTDM_IN47	FTDM mapping for the serial inputs (Channel 43, Bits[7:0])

Address	Register	Description
0xF330	FTDM_IN48	FTDM mapping for the serial inputs (Channel 44, Bits[31:24])
0xF331	FTDM_IN49	FTDM mapping for the serial inputs (Channel 44, Bits[23:16])
0xF332	FTDM_IN50	FTDM mapping for the serial inputs (Channel 44, Bits[15:8])
0xF333	FTDM_IN51	FTDM mapping for the serial inputs (Channel 44, Bits[7:0])
0xF334	FTDM_IN52	FTDM mapping for the serial inputs (Channel 45, Bits[31:24])
0xF335	FTDM_IN53	FTDM mapping for the serial inputs (Channel 45, Bits[23:16])
0xF336	FTDM_IN54	FTDM mapping for the serial inputs (Channel 45, Bits[15:8])
0xF337	FTDM_IN55	FTDM mapping for the serial inputs (Channel 45, Bits[7:0])
0xF338	FTDM_IN56	FTDM mapping for the serial inputs (Channel 46, Bits[31:24])
0xF339	FTDM_IN57	FTDM mapping for the serial inputs (Channel 46, Bits[23:16])
0xF33A	FTDM_IN58	FTDM mapping for the serial inputs (Channel 46, Bits[15:8])
0xF33B	FTDM_IN59	FTDM mapping for the serial inputs (Channel 46, Bits[7:0])
0xF33C	FTDM_IN60	FTDM mapping for the serial inputs (Channel 47, Bits[31:24])
0xF33D	FTDM_IN61	FTDM mapping for the serial inputs (Channel 47, Bits[23:16])
0xF33E	FTDM_IN62	FTDM mapping for the serial inputs (Channel 47, Bits[15:8])
0xF33F	FTDM_IN63	FTDM mapping for the serial inputs (Channel 47, Bits[7:0])
0xF380	FTDM_OUT0	FTDM mapping for the serial outputs (Port 2, Channel 0, Bits[31:24])
0xF381	FTDM_OUT1	FTDM mapping for the serial outputs (Port 2, Channel 0, Bits[23:16])
0xF382	FTDM_OUT2	FTDM mapping for the serial outputs (Port 2, Channel 0, Bits[15:8])
0xF383	FTDM_OUT3	FTDM mapping for the serial outputs (Port 2, Channel 0, Bits[7:0])
0xF384	FTDM_OUT4	FTDM mapping for the serial outputs (Port 2, Channel 1, Bits[31:24])
0xF385	FTDM_OUT5	FTDM mapping for the serial outputs (Port 2, Channel 1, Bits[23:16])
0xF386	FTDM_OUT6	FTDM mapping for the serial outputs (Port 2, Channel 1, Bits[15:8])
0xF387	FTDM_OUT7	FTDM mapping for the serial outputs (Port 2, Channel 1, Bits[7:0])
0xF388	FTDM_OUT8	FTDM mapping for the serial outputs (Port 2, Channel 2, Bits[31:24])
0xF389	FTDM_OUT9	FTDM mapping for the serial outputs (Port 2, Channel 2, Bits[23:16])
0xF38A	FTDM_OUT10	FTDM mapping for the serial outputs (Port 2, Channel 2, Bits[15:8])
0xF38B	FTDM_OUT11	FTDM mapping for the serial outputs (Port 2, Channel 2, Bits[7:0])
0xF38C	FTDM_OUT12	FTDM mapping for the serial outputs (Port 2, Channel 3, Bits[31:24])
0xF38D	FTDM_OUT13	FTDM mapping for the serial outputs (Port 2, Channel 3, Bits[23:16])
0xF38E	FTDM_OUT14	FTDM mapping for the serial outputs (Port 2, Channel 3, Bits[15:8])
0xF38F	FTDM_OUT15	FTDM mapping for the serial outputs (Port 2, Channel 3, Bits[7:0])
0xF390	FTDM_OUT16	FTDM mapping for the serial outputs (Port 2, Channel 4, Bits[31:24])
0xF391	FTDM_OUT17	FTDM mapping for the serial outputs (Port 2, Channel 4, Bits[23:16])
0xF392	FTDM_OUT18	FTDM mapping for the serial outputs (Port 2, Channel 4, Bits[15:8])
0xF393	FTDM_OUT19	FTDM mapping for the serial outputs (Port 2, Channel 4, Bits[7:0])
0xF394	FTDM_OUT20	FTDM mapping for the serial outputs (Port 2, Channel 5, Bits[31:24])
0xF395	FTDM_OUT21	FTDM mapping for the serial outputs (Port 2, Channel 5, Bits[23:16])
0xF396	FTDM_OUT22	FTDM mapping for the serial outputs (Port 2, Channel 5, Bits[15:8])
0xF397	FTDM_OUT23	FTDM mapping for the serial outputs (Port 2, Channel 5, Bits[7:0])
0xF398	FTDM_OUT24	FTDM mapping for the serial outputs (Port 2, Channel 6, Bits[31:24])
0xF399	FTDM_OUT25	FTDM mapping for the serial outputs (Port 2, Channel 6, Bits[23:16])
0xF39A	FTDM_OUT26	FTDM mapping for the serial outputs (Port 2, Channel 6, Bits[15:8])
0xF39B	FTDM_OUT27	FTDM mapping for the serial outputs (Port 2, Channel 6, Bits[7:0])
0xF39C	FTDM_OUT28	FTDM mapping for the serial outputs (Port 2, Channel 7, Bits[31:24])
0xF39D	FTDM_OUT29	FTDM mapping for the serial outputs (Port 2, Channel 7, Bits[23:16])
0xF39E	FTDM_OUT30	FTDM mapping for the serial outputs (Port 2, Channel 7, Bits[15:8])
0xF39F	FTDM_OUT31	FTDM mapping for the serial outputs (Port 2, Channel 7, Bits[7:0])
0xF3A0	FTDM_OUT32	FTDM mapping for the serial outputs (Port 3, Channel 0, Bits[31:24])
0xF3A1	FTDM_OUT33	FTDM mapping for the serial outputs (Port 3, Channel 0, Bits[23:16])
0xF3A2	FTDM_OUT34	FTDM mapping for the serial outputs (Port 3, Channel 0, Bits[15:8])
0xF3A3	FTDM_OUT35	FTDM mapping for the serial outputs (Port 3, Channel 0, Bits[7:0])
0xF3A4	FTDM_OUT36	FTDM mapping for the serial outputs (Port 3, Channel 1, Bits[31:24])
0xF3A5	FTDM_OUT37	FTDM mapping for the serial outputs (Port 3, Channel 1, Bits[23:16])



Address	Register	Description
0xF3A6	FTDM_OUT38	FTDM mapping for the serial outputs (Port 3, Channel 1, Bits[15:8])
0xF3A7	FTDM_OUT39	FTDM mapping for the serial outputs (Port 3, Channel 1, Bits[7:0])
0xF3A8	FTDM_OUT40	FTDM mapping for the serial outputs (Port 3, Channel 2, Bits[31:24])
0xF3A9	FTDM_OUT41	FTDM mapping for the serial outputs (Port 3, Channel 2, Bits[23:16])
0xF3AA	FTDM_OUT42	FTDM mapping for the serial outputs (Port 3, Channel 2, Bits[15:8])
0xF3AB	FTDM_OUT43	FTDM mapping for the serial outputs (Port 3, Channel 2, Bits[7:0])
0xF3AC	FTDM_OUT44	FTDM mapping for the serial outputs (Port 3, Channel 3, Bits[31:24])
0xF3AD	FTDM_OUT45	FTDM mapping for the serial outputs (Port 3, Channel 3, Bits[23:16])
0xF3AE	FTDM_OUT46	FTDM mapping for the serial outputs (Port 3, Channel 3, Bits[15:8])
0xF3AF	FTDM_OUT47	FTDM mapping for the serial outputs (Port 3, Channel 3, Bits[7:0])
0xF3B0	FTDM_OUT48	FTDM mapping for the serial outputs (Port 3, Channel 4, Bits[31:24])
0xF3B1	FTDM_OUT49	FTDM mapping for the serial outputs (Port 3, Channel 4, Bits[23:16])
0xF3B2	FTDM_OUT50	FTDM mapping for the serial outputs (Port 3, Channel 4, Bits[15:8])
0xF3B3	FTDM_OUT51	FTDM mapping for the serial outputs (Port 3, Channel 4, Bits[7:0])
0xF3B4	FTDM_OUT52	FTDM mapping for the serial outputs (Port 3, Channel 5, Bits[31:24])
0xF3B5	FTDM_OUT53	FTDM mapping for the serial outputs (Port 3, Channel 5, Bits[23:16])
0xF3B6	FTDM_OUT54	FTDM mapping for the serial outputs (Port 3, Channel 5, Bits[15:8])
0xF3B7	FTDM_OUT55	FTDM mapping for the serial outputs (Port 3, Channel 5, Bits[7:0])
0xF3B8	FTDM_OUT56	FTDM mapping for the serial outputs (Port 3, Channel 6, Bits[31:24])
0xF3B9	FTDM_OUT57	FTDM mapping for the serial outputs (Port 3, Channel 6, Bits[23:16])
0xF3BA	FTDM_OUT58	FTDM mapping for the serial outputs (Port 3, Channel 6, Bits[15:8])
0xF3BB	FTDM_OUT59	FTDM mapping for the serial outputs (Port 3, Channel 6, Bits[7:0])
0xF3BC	FTDM_OUT60	FTDM mapping for the serial outputs (Port 3, Channel 7, Bits[31:24])
0xF3BD	FTDM_OUT61	FTDM mapping for the serial outputs (Port 3, Channel 7, Bits[23:16])
0xF3BE	FTDM_OUT62	FTDM mapping for the serial outputs (Port 3, Channel 7, Bits[15:8])
0xF3BF	FTDM_OUT63	FTDM mapping for the serial outputs (Port 3, Channel 7, Bits[7:0])

## ASYNCHRONOUS SAMPLE RATE CONVERTERS

Sixteen channels of integrated asynchronous sample rate converters are available in the [ADAU1452](#) and [ADAU1451](#). These sample rate converters are capable of receiving audio data input signals, along with their corresponding clocks, and resynchronizing the data stream to an arbitrary target sample rate. The sample rate converters use some filtering to accomplish this task; therefore, the data output from the sample rate converter is not a bit-accurate representation of the data input.

The [ADAU1450](#) has no ASRCs, so any data routed to the ASRCs using the audio routing matrix or DSP core are lost.

The 16 channels of sample rate converters are grouped into eight stereo sets. These eight stereo sample rate converters are individually configurable and are referred to as ASRC 0 through ASRC 7. Channel 0 and Channel 1 belong to ASRC 0, Channel 2 and Channel 3 belong to ASRC 1, Channel 4 and Channel 5 belong to ASRC 2, Channel 6 and Channel 7 belong to ASRC 3, Channel 8 and Channel 9 belong to ASRC 4, Channel 10 and Channel 11 belong to ASRC 5, Channel 12 and Channel 13 belong to ASRC 6, and Channel 14 and Channel 15 belong to ASRC 7.

Audio is routed to the sample rate converters using the ASRC\_INPUTx registers, and the target sample rate of each ASRC is configured using the ASRC\_OUT\_RATEx registers. A complete description of audio routing is included in the Audio Signal Routing section.

### Asynchronous Sample Rate Converter Group Delay

The group delay of the sample rate converter is dependent on the input and output sampling frequencies as described in the following equations:

For  $f_{S\_OUT} > f_{S\_IN}$ ,

$$GDS = \frac{16}{f_{S\_IN}} + \frac{32}{f_{S\_IN}}$$

For  $f_{S\_OUT} < f_{S\_IN}$ ,

$$GDS = \frac{16}{f_{S\_IN}} + \left( \frac{32}{f_{S\_IN}} \right) \times \left( \frac{f_{S\_IN}}{f_{S\_OUT}} \right)$$

where  $GDS$  is the group delay in seconds.

**ASRC Lock**

Each ASRC monitors the incoming signal and attempts to lock on to the clock and data signals. When a valid signal is detected and several consecutive valid samples are received, and there is a valid output target sample rate, the corresponding bit in Register 0xF580 (ASRC\_LOCK) signifies that the ASRC has successfully locked to the incoming signal.

**ASRC Muting**

The ASRC outputs can be manually muted at any time using the corresponding bits in Register 0xF581 (ASRC\_MUTE). However, for creating a smooth volume ramp when muting audio signals, more options are available in the DSP core; therefore, in most cases, using the DSP program to manually mute signals is preferable to using Register 0xF581.

**Asynchronous Sample Rate Converters Registers**

An overview of the registers related to the ASRCs is shown in Table 51. For a more detailed description, refer to the ASRC Status and Control Registers section.

**Table 51. Asynchronous Sample Rate Converters Registers**

Address	Register	Description
0xF580	ASRC_LOCK	ASRC lock status
0xF581	ASRC_MUTE	ASRC mute
0xF582	ASRC0_RATIO	ASRC ratio (ASRC 0, Channel 0 and Channel 1)
0xF583	ASRC1_RATIO	ASRC ratio (ASRC 1, Channel 2 and Channel 3)
0xF584	ASRC2_RATIO	ASRC ratio (ASRC 2, Channel 4 and Channel 5)
0xF585	ASRC3_RATIO	ASRC ratio (ASRC 3, Channel 6 and Channel 7)
0xF586	ASRC4_RATIO	ASRC ratio (ASRC 4, Channel 8 and Channel 9)
0xF587	ASRC5_RATIO	ASRC ratio (ASRC 5, Channel 10 and Channel 11)
0xF588	ASRC6_RATIO	ASRC ratio (ASRC 6, Channel 12 and Channel 13)
0xF589	ASRC7_RATIO	ASRC ratio (ASRC 7, Channel 14 and Channel 15)

**S/PDIF INTERFACE**

For easy interfacing on the system level, wire the on-chip S/PDIF receiver and transmitter data ports directly to other S/PDIF-compatible equipment. The S/PDIF receiver consists of two audio channels input on one hardware pin (SPDIFIN). The clock signal is embedded in the data using biphasic mark code. The S/PDIF transmitter consists of two audio channels output on one hardware pin (SPDIFOUT). The clock signal is embedded in the data using biphasic mark code. The S/PDIF input and output word lengths can be independently set to 16, 20, or 24 bits.

The S/PDIF interface meets the S/PDIF consumer performance specification. It does not meet the AES3 professional specification.

The ADAU1450 does not include S/PDIF interfaces, so its SPDIFIN and SPDIFOUT pins are nonfunctional and should remain disconnected.

**S/PDIF Receiver**

The S/PDIF input port is designed to accept both TTL and bipolar signals, provided there is an ac coupling capacitor on the input pin of the chip. Because the S/PDIF input data is most likely asynchronous to the DSP core, it must be routed through an ASRC.

The S/PDIF receiver works at a wide range of sampling frequencies between 18 kHz and 96 kHz.

The S/PDIF receiver input is a comparator that is centered at IOVDD/2 and requires an input signal level of at least 200 mV p-p to operate properly.

In addition to audio data, S/PDIF streams contain user data, channel status, validity bit, virtual LRCLK, and block start information. The receiver decodes audio data and sends it to the corresponding registers in the control register map, where the information can be read over the I<sup>2</sup>C or SPI slave port.

For improved jitter performance, the S/PDIF clock recovery implementation is completely digital. The S/PDIF ports are designed to meet the following AES and EBU specifications: a jitter of 0.25 UI p-p at 8 kHz and above, a jitter of 10 UI p-p below 200 Hz, and a minimum signal voltage of 200 mV.

**S/PDIF Transmitter**

The S/PDIF transmitter outputs two channels of audio data directly from the DSP core at the core rate. The extra nonaudio data bits on the transmitted signal can be copied directly from the S/PDIF receiver or programmed manually, using the corresponding registers in the control register map.

### Auxiliary Output Mode

The received data on the S/PDIF receiver can be converted to a TDM8 stream, bypass the SigmaDSP core, and be output directly on a serial data output pin. This mode of operation is called auxiliary output mode. Configure this mode using Register 0xF608 (SPDIF\_AUX\_EN). The TDM8 output from the S/PDIF receiver regroups the recovered data in a TDM-like format, as shown in Table 52.

The S/PDIF receiver, when operating in auxiliary output mode, also recovers the embedded BCLK\_OUTx and LRCLK\_OUTx signals in the S/PDIF stream and outputs them on the corresponding BCLK\_OUTx and LRCLK\_OUTx pins in master mode when Register 0xF608 (SPDIF\_AUX\_EN), Bits[3:0] (TDMOUT), are configured to enable auxiliary output mode. The selected BCLK\_OUTx signal has a frequency of 256× the recovered sample rate, and the LRCLK\_OUTx signal is a 50-50 duty cycle square wave that has the same frequency as the audio sample rate (see Table 130).

Table 52. S/PDIF Auxiliary Output Mode, TDM8 Data Format

TDM8 Channel	Description of Data Format
0	8 zero bits followed by 24 audio bits, recovered from the left audio channel of the S/PDIF stream
1	28 zero bits followed by the left parity bit, left validity bit, left user data, and left channel status
2	30 zero bits followed by the compression type bit (0b0 = AC3, 0b1 = DTS) and the audio type bit (0 = PCM, 1 = compressed)
3	No data
4	8 zero bits followed by 24 audio bits, recovered from the right audio channel of the S/PDIF stream
5	28 zero bits followed by the right parity bit, right validity bit, right user data, and right channel status
6	No data
7	31 zero bits followed by the block start signal

### S/PDIF Interface Registers

An overview of the registers related to the S/PDIF interface is shown in Table 53. For a more detailed description, refer to the S/PDIF Interface Registers section.

Table 53. S/PDIF Interface Registers

Address	Register	Description
0xF600	SPDIF_LOCK_DET	S/PDIF receiver lock bit detection
0xF601	SPDIF_RX_CTRL	S/PDIF receiver control
0xF602	SPDIF_RX_DECODE	Decoded signals from the S/PDIF receiver
0xF603	SPDIF_RX_COMPRMODE	Compression mode from the S/PDIF receiver
0xF604	SPDIF_RESTART	Automatically resume S/PDIF receiver audio input
0xF605	SPDIF_LOSS_OF_LOCK	S/PDIF receiver loss of lock detection
0xF608	SPDIF_AUX_EN	S/PDIF receiver auxiliary outputs enable
0xF60F	SPDIF_RX_AUXBIT_READY	S/PDIF receiver auxiliary bits ready flag
0xF610 to 0xF61B	SPDIF_RX_CS_LEFT_x	S/PDIF receiver channel status bits (left)
0xF620 to 0xF62B	SPDIF_RX_CS_RIGHT_x	S/PDIF receiver channel status bits (right)
0xF630 to 0xF63B	SPDIF_RX_UD_LEFT_x	S/PDIF receiver user data bits (left)
0xF640 to 0xF64B	SPDIF_RX_UD_RIGHT_x	S/PDIF receiver user data bits (right)
0xF650 to 0xF65B	SPDIF_RX_VB_LEFT_x	S/PDIF receiver validity bits (left)
0xF660 to 0xF66B	SPDIF_RX_VB_RIGHT_x	S/PDIF receiver validity bits (right)
0xF670 to 0xF67B	SPDIF_RX_PB_LEFT_x	S/PDIF receiver parity bits (left)
0xF680 to 0xF68B	SPDIF_RX_PB_RIGHT_x	S/PDIF receiver parity bits (right)
0xF690	SPDIF_TX_EN	S/PDIF transmitter enable
0xF691	SPDIF_TX_CTRL	S/PDIF transmitter control
0xF69F	SPDIF_TX_AUXBIT_SOURCE	S/PDIF transmitter auxiliary bits source select
0xF6A0 to 0xF6AB	SPDIF_TX_CS_LEFT_x	S/PDIF transmitter channel status bits (left)
0xF6B0 to 0xF6BB	SPDIF_TX_CS_RIGHT_x	S/PDIF transmitter channel status bits (right)
0xF6C0 to 0xF6CB	SPDIF_TX_UD_LEFT_x	S/PDIF transmitter user data bits (left)
0xF6D0 to 0xF6DB	SPDIF_TX_UD_RIGHT_x	S/PDIF transmitter user data bits (right)
0xF6E0 to 0xF6EB	SPDIF_TX_VB_LEFT_x	S/PDIF transmitter validity bits (left)
0xF6F0 to 0xF6FB	SPDIF_TX_VB_RIGHT_x	S/PDIF transmitter validity bits (right)
0xF700 to 0xF70B	SPDIF_TX_PB_LEFT_x	S/PDIF transmitter parity bits (left)
0xF710 to 0xF71B	SPDIF_TX_PB_RIGHT_x	S/PDIF transmitter parity bits (right)

**DIGITAL PDM MICROPHONE INTERFACE**

Up to four pulse density modulation (PDM) microphones can be connected as audio inputs. Each pair of microphones can share a single data line; therefore, using four PDM microphones requires two GPIO pins. Any multipurpose pin can be used as a microphone data input, with up to two microphones connected to each pin. This configuration is set up using the corresponding MPx\_MODE and DMIC\_CTRLx registers.

A bit clock pin from one of the serial input clock domains (BCLK\_INx) or one of the serial output clock domains (BCLK\_OUTx) must be a master clock source, and its output signal must be connected to the PDM microphones to provide them with a clock.

PDM microphones, such as the ADMP522 from InvenSense, typically require a bit clock frequency in the range of 1 MHz to 3.3 MHz, corresponding to audio sample rates of 15.625 kHz to 51.5625 kHz. This means that the serial port corresponding to the BCLK\_INx pin or BCLK\_OUTx pin driving the PDM microphones should operate in 2-channel mode at a sample rate between 16 kHz and 48 kHz.

PDM microphone inputs are automatically routed through decimation filters and then are available for use at the DSP core, the ASRCs, and the serial output ports.

Figure 72 shows an example circuit with two ADMP522 PDM output MEMS microphones connected to the ADAU1452. Any of the BCLK\_INx pins or BCLK\_OUTx pins can be used to provide a clock signal to the microphones, and the data output of the microphones can be connected to any MPx pin that has been configured as a PDM microphone data input.

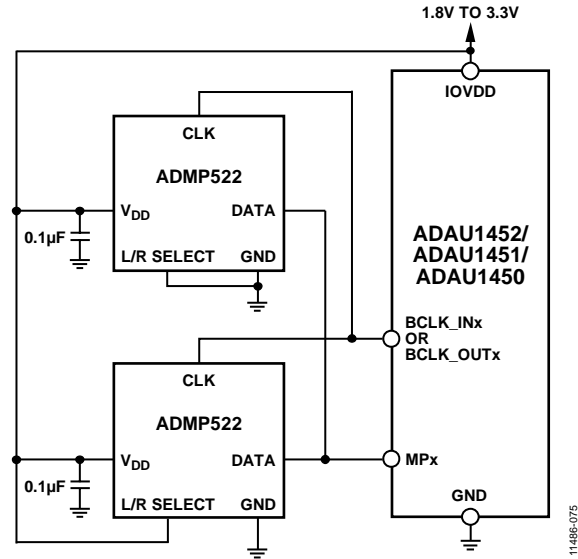

Figure 72. Example Stereo PDM Microphone Input Circuit

**Digital PDM Microphone Interface Registers**

An overview of the registers related to the digital microphone interface is shown in Table 54. For a more detailed description, see the Digital PDM Microphone Control Register.

**Table 54. Digital PDM Microphone Interface Registers**

Address	Register	Description
0xF560	DMIC_CTRL0	Digital PDM microphone control (Channel 0 and Channel 1)
0xF561	DMIC_CTRL1	Digital PDM microphone control (Channel 2 and Channel 3)

**MULTIPURPOSE PINS**

A total of 14 pins are available for use as general-purpose inputs or outputs (GPIO) that are multiplexed with other functions, such as clock inputs/outputs. Because these pins have multiple functions, they are referred to as multipurpose pins, or MPx pins.

Multipurpose pins can be configured in several modes using the MPx\_MODE registers:

- Hardware input from pin
- Software input (written via I<sup>2</sup>C or SPI slave control port)
- Hardware output with internal pull-up
- Hardware output without internal pull-up
- PDM microphone data input
- Flag output from panic manager
- Slave select line for master SPI port

When configured in hardware input mode, a debounce circuit is available to avoid data glitches.

When operating in GPIO mode, pin status is updated once per sample. This means that the state of a GPIO (MPx pin) cannot change more than once in a sample period.

**General-Purpose Inputs to the DSP Core**

When a multipurpose pin is configured as a general-purpose input, its value can be used as a control logic signal in the DSP program, which is configured using SigmaStudio. Figure 73 shows the location of the general-purpose input cell within the SigmaStudio toolbox.

The 14 available general-purpose inputs in SigmaStudio map to the corresponding 14 multipurpose pins, but their data is valid only if the corresponding multipurpose pin has been configured as an input using the MPx\_MODE registers. Figure 75 shows all of the general-purpose inputs as they appear in the SigmaStudio signal flow.

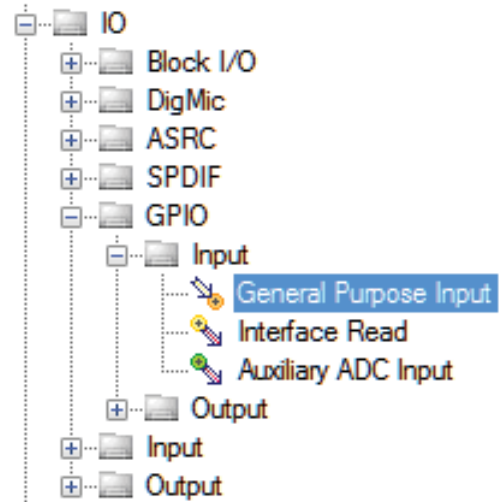

Figure 73. General-Purpose Input in the SigmaStudio Toolbox

**General-Purpose Outputs from the DSP Core**

When a multipurpose pin is configured as a general-purpose output, a Boolean value is output from the DSP program to the corresponding multipurpose pin. Figure 74 shows the location of the general-purpose output cell within the SigmaStudio toolbox.

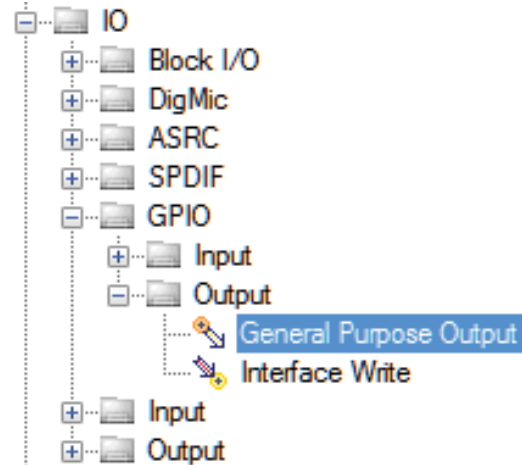

Figure 74. General-Purpose Output in the SigmaStudio Toolbox



Figure 75. Complete Set of General-Purpose Inputs in SigmaStudio

The 14 available general-purpose outputs in SigmaStudio map to the corresponding 14 multipurpose pins, but their data is output to the pin only if the corresponding multipurpose pin is

configured as an output using the MPx\_MODE registers. Figure 76 shows all of the general-purpose inputs as they appear in the SigmaStudio signal flow.



Figure 76. Complete Set of General-Purpose Outputs in SigmaStudio

11486-079

**Multipurpose Pin Registers**

An overview of the registers related to GPIO is shown in Table 55. For a more detailed description, refer to the Multipurpose Pin Configuration Registers section.

**Table 55. Multipurpose Pins Registers**

Address	Register	Description
0xF510	MP0_MODE	Multipurpose pin mode (SS_M/MP0)
0xF511	MP1_MODE	Multipurpose pin mode (MOSI_M/MP1)
0xF512	MP2_MODE	Multipurpose pin mode (SCL_M/SCLK_M/MP2)
0xF513	MP3_MODE	Multipurpose pin mode (SDA_M/MISO_M/MP3)
0xF514	MP4_MODE	Multipurpose pin mode (LRCLK_OUT0/MP4)
0xF515	MP5_MODE	Multipurpose pin mode (LRCLK_OUT1/MP5)
0xF516	MP6_MODE	Multipurpose pin mode (MP6)
0xF517	MP7_MODE	Multipurpose pin mode (MP7)
0xF518	MP8_MODE	Multipurpose pin mode (LRCLK_OUT2/MP8)
0xF519	MP9_MODE	Multipurpose pin mode (LRCLK_OUT3/MP9)
0xF51A	MP10_MODE	Multipurpose pin mode (LRCLK_IN0/MP10)
0xF51B	MP11_MODE	Multipurpose pin mode (LRCLK_IN1/MP11)
0xF51C	MP12_MODE	Multipurpose pin mode (LRCLK_IN2/MP12)
0xF51D	MP13_MODE	Multipurpose pin mode (LRCLK_IN3/MP13)
0xF520	MP0_WRITE	Multipurpose pin write value (SS_M/MP0)
0xF521	MP1_WRITE	Multipurpose pin write value (MOSI_M/MP1)
0xF522	MP2_WRITE	Multipurpose pin write value (SCL_M/SCLK_M/MP2)
0xF523	MP3_WRITE	Multipurpose pin write value (SDA_M/MISO_M/MP3)
0xF524	MP4_WRITE	Multipurpose pin write value (LRCLK_OUT0/MP4)
0xF525	MP5_WRITE	Multipurpose pin write value (LRCLK_OUT1/MP5)
0xF526	MP6_WRITE	Multipurpose pin write value (MP6)
0xF527	MP7_WRITE	Multipurpose pin write value (MP7)
0xF528	MP8_WRITE	Multipurpose pin write value (LRCLK_OUT2/MP8)
0xF529	MP9_WRITE	Multipurpose pin write value (LRCLK_OUT3/MP9)
0xF52A	MP10_WRITE	Multipurpose pin write value (LRCLK_IN0/MP10)
0xF52B	MP11_WRITE	Multipurpose pin write value (LRCLK_IN1/MP11)
0xF52C	MP12_WRITE	Multipurpose pin write value (LRCLK_IN2/MP12)
0xF52D	MP13_WRITE	Multipurpose pin write value (LRCLK_IN3/MP13)
0xF530	MP0_READ	Multipurpose pin read value (SS_M/MP0)
0xF531	MP1_READ	Multipurpose pin read value (MOSI_M/MP1)
0xF532	MP2_READ	Multipurpose pin read value (SCL_M/SCLK_M/MP2)
0xF533	MP3_READ	Multipurpose pin read value (SDA_M/MISO_M/MP3)
0xF534	MP4_READ	Multipurpose pin read value (LRCLK_OUT0/MP4)
0xF535	MP5_READ	Multipurpose pin read value (LRCLK_OUT1/MP5)
0xF536	MP6_READ	Multipurpose pin read value (MP6)
0xF537	MP7_READ	Multipurpose pin read value (MP7)
0xF538	MP8_READ	Multipurpose pin read value (LRCLK_OUT2/MP8)
0xF539	MP9_READ	Multipurpose pin read value (LRCLK_OUT3/MP9)
0xF53A	MP10_READ	Multipurpose pin read value (LRCLK_IN0/MP10)
0xF53B	MP11_READ	Multipurpose pin read value (LRCLK_IN1/MP11)
0xF53C	MP12_READ	Multipurpose pin read value (LRCLK_IN2/MP12)
0xF53D	MP13_READ	Multipurpose pin read value (LRCLK_IN3/MP13)



**AUXILIARY ADC**

There are six auxiliary ADC inputs with 10 bits of accuracy. They are intended to be used as control signal inputs, such as potentiometer outputs or battery monitor signals.

The auxiliary ADC samples each channel at a frequency of the core system clock divided by 6144. In the case of a default clocking scheme, the system clock is 294.912 MHz; thus, the auxiliary ADC sample rate is 48 kHz. If the system clock is scaled down by configuring the PLL to generate a lower output frequency, the auxiliary ADC sample rate is scaled down proportionately.

The auxiliary ADC is referenced so that a full-scale input is achieved when the input voltage is equal to AVDD, and an input of zero is achieved when the input is connected to ground.

The input impedance of the auxiliary ADC is approximately 200 kΩ at dc (zero hertz).

Auxiliary ADC inputs can be used directly in the DSP program (as configured in the SigmaStudio software). The instantaneous value of each ADC is also available in the ADC\_READx registers, which are accessible via the I<sup>2</sup>C or SPI slave control port.

**Auxiliary ADC Inputs to the DSP Core**

Auxiliary ADC inputs can be used as control signals in the DSP program as configured by SigmaStudio. Figure 77 shows the location of the auxiliary ADC input cell in the SigmaStudio toolbox.

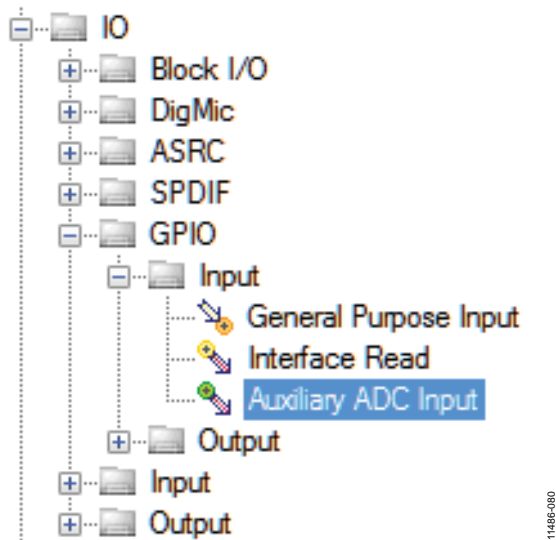

Figure 77. Auxiliary ADC Input Cell in the SigmaStudio Toolbox

The six auxiliary input pins map to the corresponding six auxiliary ADC input cells. Figure 78 shows the complete set of auxiliary ADC input cells in SigmaStudio.



Figure 78. Complete Set of Auxiliary ADC Inputs in SigmaStudio

**Auxiliary ADC Registers**

An overview of the registers related to the auxiliary ADC is shown in Table 56. For a more detailed description, see the Auxiliary ADC Registers section.

Table 56. Auxiliary ADC Registers

Address	Register	Description
0xF5A0	ADC_READ0	Auxiliary ADC read value (AUXADC0)
0xF5A1	ADC_READ1	Auxiliary ADC read value (AUXADC1)
0xF5A2	ADC_READ2	Auxiliary ADC read value (AUXADC2)
0xF5A3	ADC_READ3	Auxiliary ADC read value (AUXADC3)
0xF5A4	ADC_READ4	Auxiliary ADC read value (AUXADC4)
0xF5A5	ADC_READ5	Auxiliary ADC read value (AUXADC5)

**SigmaDSP CORE**

The SigmaDSP core operates at a maximum frequency of 294.912 MHz (or 147.456 MHz in the ADAU1450), which is equivalent to 6144 clock cycles per sample at a sample rate of 48 kHz (or 3072 clock cycles per sample in the ADAU1450). For a sample rate of 48 kHz, the largest program possible consists of 6144 program instructions per sample (or 3072 instructions per sample in the ADAU1450). If the system clock remains at 294.912 MHz but the audio frame rate of the DSP core is decreased, programs consisting of more than 6144 instructions per sample are possible. The program RAM is 8192 words long, so the largest program possible (but only at lower sample rates) is 8192 instructions per frame.

The core consists of four multipliers and two accumulators. At an operating frequency of 294.912 MHz, the core performs 1.2 billion MAC operations per second. At maximum efficiency, the core processes 3072 IIR biquad filters (single or double precision) per sample at a sample rate of 48 kHz. At maximum efficiency, the core processes approximately 24,000 FIR filter taps per sample at a sample rate of 48 kHz. The instruction set is a single instruction, multiple data (SIMD) computing model. The DSP core is 32-bit fixed-point, with an 8.24 data format for audio.



The four multipliers are 64-bit double precision, capable of multiplying an 8.56 format number by an 8.24 number. The multiply accumulators consist of 16 registers, with a depth of 80 bits. The core can access RAM with a load/store width of 256 bits (eight 32-bit words per frame). The two ALUs have an 80-bit width and operate on numbers in 24.56 format. The 24.56-bit format provides more than 42 dB of headroom.

It is possible to create combinations of time domain and frequency domain processing, using block and sample frame interrupts. Sixteen data address generator (DAG) registers are available, and circular buffer addressing is possible.

Many of the signal processing functions are coded using full, 64-bit, double precision arithmetic. The serial port input and output word lengths are 24 bits, but eight extra headroom bits are used in the processor to allow internal gains of up to 48 dB without clipping. Additional gains can be achieved by initially scaling down the input signal in the DSP signal flow.

**Numeric Formats**

DSP systems commonly use a standard numeric format. Fractional number systems are specified by an A.B format, where A is the number of bits to the left of the decimal point and B is the number of bits to the right of the decimal point.

The same numeric format is used for both the parameter and data values.

A digital clipper circuit is used within the DSP core before outputting to the serial port outputs, ASRCs, and S/PDIF. This clips the top seven bits (and the least significant bit) of the signal to produce a 24-bit output with a range of +1.0 (minus 1 LSB) to -1.0. Figure 79 shows the maximum signal levels at each point in the data flow in both binary and decibel levels.

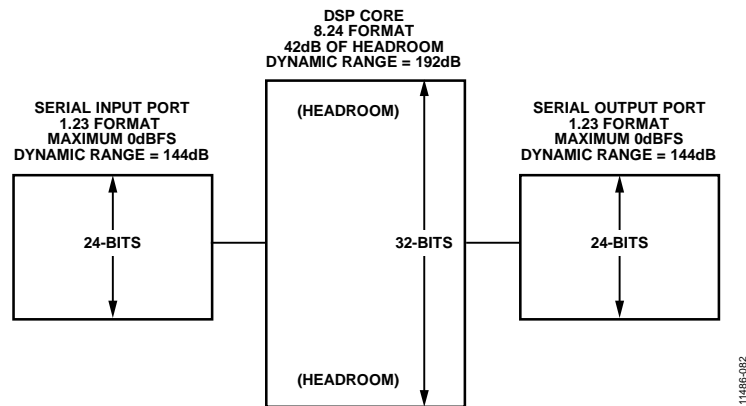

Figure 79. Signal Range for 1.23 Format (Serial Ports, ASRCs) and 8.24 Format (DSP Core)

**Numerical Format: 8.24**

Linear range: -128.0 to (+128.0 - 1 LSB)

Dynamic range (ratio of the largest possible signal level to the smallest possible non-zero signal level): 192 dB

Examples:

- 0b 1000 0000 0000 0000 0000 0000 0000 0000 = 0x80000000 = -128.0
- 0b 1110 0000 0000 0000 0000 0000 0000 0000 = 0xE0000000 = -32.0
- 0b 1111 1000 0000 0000 0000 0000 0000 0000 = 0xF8000000 = -8.0
- 0b 1111 1110 0000 0000 0000 0000 0000 0000 = 0xFE000000 = -2
- 0b 1111 1111 0000 0000 0000 0000 0000 0000 = 0xFF000000 = -1
- 0b 1111 1111 1000 0000 0000 0000 0000 0000 = 0xFF800000 = -0.5
- 0b 1111 1111 1110 0110 0110 0110 0110 0110 = 0xFFE66666 = -0.1
- 0b 1111 1111 1111 1111 1111 1111 1111 1111 = 0xFFFFFFFF = -0.00000005 (1 LSB below 0.0)
- 0b 0000 0000 0000 0000 0000 0000 0000 0000 = 0x00000000 = 0.0
- 0b 0000 0000 0000 0000 0000 0000 0000 0001 = 0x00000001 = 0.00000005 (1 LSB above 0.0)
- 0b 0000 0000 0001 1001 1001 1001 1001 1001 = 0x00199999 = 0.1
- 0b 0000 0000 0100 0000 0000 0000 0000 0000 = 0x00400000 = 0.25
- 0b 0000 0000 1000 0000 0000 0000 0000 0000 = 0x00800000 = 0.5
- 0b 0000 0001 0000 0000 0000 0000 0000 0000 = 0x01000000 = 1.0
- 0b 0000 0010 0000 0000 0000 0000 0000 0000 = 0x02000000 = 2.0
- 0b 0111 1111 1111 1111 1111 1111 1111 1111 = 0x7FFFFFFF = 127.99999994 (1 LSB below 128.0)

## Numerical Format: 32.0

The 32.0 format is used for logic signals in the DSP program flow that are integers.

Linear range: -2,147,483,648 to +2,147,483,647

Dynamic range (ratio of the largest possible signal level to the smallest possible non-zero signal level): 192 dB

Examples:

```

0b 1000 0000 0000 0000 0000 0000 0000 0000 = 0x80000000 = -2147483648
0b 1000 0000 0000 0000 0000 0000 0000 0001 = 0x80000001 = -2147483647
0b 1000 0000 0000 0000 0000 0000 0000 0010 = 0x80000002 = -2147483646
0b 1100 0000 0000 0000 0000 0000 0000 0000 = 0xC0000000 = -1073741824
0b 1110 0000 0000 0000 0000 0000 0000 0000 = 0xE0000000 = -536870912
0b 1111 1111 1111 1111 1111 1111 1111 1100 = 0xFFFFFFF0 = -4
0b 1111 1111 1111 1111 1111 1111 1111 1110 = 0xFFFFFFF2 = -2
0b 1111 1111 1111 1111 1111 1111 1111 1111 = 0xFFFFFFF8 = -1
0b 0000 0000 0000 0000 0000 0000 0000 0000 = 0x00000000 = 0
0b 0000 0000 0000 0000 0000 0000 0000 0001 = 0x00000001 = 1
0b 0000 0000 0000 0000 0000 0000 0000 0010 = 0x00000002 = 2
0b 0000 0000 0000 0000 0000 0000 0000 0011 = 0x00000003 = 3
0b 0000 0000 0000 0000 0000 0000 0000 0100 = 0x00000004 = 4
0b 0111 1111 1111 1111 1111 1111 1111 1110 = 0x7FFFFFFE = 2147483646
0b 0111 1111 1111 1111 1111 1111 1111 1111 = 0x7FFFFFFF = 2147483647
    
```

## Hardware Accelerators

The core includes accelerators like division, square root, barrel shifters, base-2 logarithm, base-2 exponential, slew, and a pseudorandom number generator. This reduces the number of instructions required for complex audio processing algorithms.

The division accelerator enables efficient processing for audio algorithms like compression and limiting. The square root accelerator enables efficient processing for audio algorithms such as loudness, rms envelopes, and filter coefficient calculations. The logarithm and exponent accelerators enable efficient processing for audio algorithms involving decibel conversion. The slew accelerators provide for click-free updates of parameters that must change slowly over time, allowing for audio processing algorithms such as mixers, crossfaders, dynamic filters, and dynamic volume controls. The pseudorandom number generator can efficiently produce white noise, pink noise, and dither.

## Programming the SigmaDSP Core

The SigmaDSP is programmable via the SigmaStudio graphical development tools.

When the SigmaDSP core is running a program and the user needs to reprogram the program and data memories during operation of the device, the core must be stopped while the memory is being updated to avoid undesired noises on the DSP outputs.

The following sequence of steps is appropriate for programming the memories at boot time, or reprogramming the memories during operation:

1. Enable soft reset (Register 0xF890 (SOFT\_RESET), Bit 0 (SOFT\_RESET) = 0b0), then disable soft reset (Register 0xF890 (SOFT\_RESET), Bit 0 (SOFT\_RESET) = 0b1).
2. If the DSP is in the process of executing a program, wait for the current sample or block to finish processing. For programs with no block processing elements in the signal flow, use the length of one sample. For example, at a sample rate of 48 kHz, one sample is 1/48000 sec, or 20.83 μs. For programs with block processing elements in the signal flow, use the length of one block. For example, at a sample rate of 48 kHz, with a block size of 256 samples, one block is 256/48,000 sec, or 53.3 ms.
3. After waiting the appropriate amount of time, as defined in the previous step, download the new program and data memory contents to the corresponding memory locations using the I<sup>2</sup>C/SPI slave control port.
4. Start the DSP core (Register 0xF402 (START\_CORE), Bit 0 (START\_CORE) = 0b1).
5. Wait at least two audio samples for the DSP initialization to execute. For example, at a sample rate of 48 kHz, two samples are equal to 2/48,000 sec, or 41.66 μs.

**Reliability Features**

Several reliability features are controlled by a panic manager subsystem that monitors the state of the SigmaDSP core and memories and generates alerts if error conditions are encountered. The panic manager indicates error conditions to the user via register flags and GPIO outputs. The origin of the error can be traced to different functional blocks such as the watchdog, memory, stack, software program, and core op codes.

Although designed mostly as an aid for software development, the panic manager is also useful in monitoring the state of the memories over long periods of time, such as in applications where the system operates unattended for an extended period, and resets are infrequent. The memories in the device have a

built-in self test feature that runs automatically while the device is in operation. If a memory corruption is detected, the appropriate flag is signaled in the panic manager. The program running in the DSP core can monitor the state of the panic manager and can mute the audio outputs if an error is encountered, and external devices, such as microcontrollers, can poll the panic manager registers or monitor the multipurpose pins to perform some preprogrammed action, if necessary.

**DSP Core and Reliability Registers**

An overview of the registers related to the DSP core is shown in Table 57. For a more detailed description, see the DSP Core Control Registers section and Debug and Reliability Registers section.

**Table 57. DSP Core and Reliability Registers**

Address	Register	Description
0xF400	HIBERNATE	Hibernate setting
0xF401	START_PULSE	Start pulse selection
0xF402	START_CORE	Instruction to start the core
0xF403	KILL_CORE	Instruction to stop the core
0xF404	START_ADDRESS	Start address of the program
0xF405	CORE_STATUS	Core status
0xF421	PANIC_CLEAR	Clear the panic manager
0xF422	PANIC_PARITY_MASK	Panic parity
0xF423	PANIC_SOFTWARE_MASK	Panic Mask 0
0xF424	PANIC_WD_MASK	Panic Mask 1
0xF425	PANIC_STACK_MASK	Panic Mask 2
0xF426	PANIC_LOOP_MASK	Panic Mask 3
0xF427	PANIC_FLAG	Panic flag
0xF428	PANIC_CODE	Panic code
0xF432	EXECUTE_COUNT	Execute stage error program count
0xF443	WATCHDOG_MAXCOUNT	Watchdog maximum count
0xF444	WATCHDOG_PRESCALE	Watchdog prescale
0xF450	BLOCKINT_EN	Enable block interrupts
0xF451	BLOCKINT_VALUE	Value for the block interrupt counter
0xF460	PROG_CNTR0	Program counter, Bits[23:16]
0xF461	PROG_CNTR1	Program counter, Bits[15:0]
0xF462	PROG_CNTR_CLEAR	Program counter clear
0xF463	PROG_CNTR_LENGTH0	Program counter length, Bits[23:16]
0xF464	PROG_CNTR_LENGTH1	Program counter length, Bits[15:0]
0xF465	PROG_CNTR_MAXLENGTH0	Program counter maximum length, Bits[23:16]

**SOFTWARE FEATURES**

**Software SafeLoad**

To update parameters in real time while avoiding pop and click noises on the output, a software safeload mechanism has been implemented by default in the SigmaStudio compiler. SigmaStudio automatically sets up the necessary code and parameters for all new projects. The safeload code, together with other initialization code, fills the beginning section of program RAM. Several data memory locations are reserved by the compiler for use with the software safeload feature. The exact parameter addresses are not fixed, so the addresses must be obtained by reading the log file generated by the compiler. In most cases, the addresses for software safeload parameters match the defaults shown in Table 58.

**Table 58. Software SafeLoad Memory Address Defaults**

Address (Hex)	Parameter	Function
0x0014	data_SafeLoad[0]	Safeload Data Slot 0
0x0015	data_SafeLoad[1]	Safeload Data Slot 1
0x0016	data_SafeLoad[2]	Safeload Data Slot 2
0x0017	data_SafeLoad[3]	Safeload Data Slot 3
0x0018	data_SafeLoad[4]	Safeload Data Slot 4
0x0019	address_SafeLoad	Target address for safeload transfer
0x001A	num_SafeLoad	Number of words to write/safeload trigger

The first five addresses in Table 58 are the five data\_SafeLoad parameters, which are slots for storing the data that is going to be transferred into another target memory location. The safeload parameter space contains five data slots, by default, because most standard signal processing algorithms have five parameters or fewer.

The address\_SafeLoad parameter is the target address in parameter RAM. This designates the first address to be written in the safeload transfer. If more than one word is written, the address increments automatically for each data-word.

The num\_SafeLoad parameter designates the number of words to be written. For a biquad filter algorithm, the number of words to be written is five because there are five coefficients in a biquad IIR filter. For a simple mono gain algorithm, the number of words to be written is one. This parameter also serves as the trigger; when it is written, a safeload write is triggered on the next frame.

The safeload mechanism is software based and executes once per audio frame. Therefore, system designers must take care when designing the communication protocol. A delay that is equal to or greater than the sampling period (the inverse of the sampling frequency) is required between each safeload write. At a sample rate of 48 kHz, this equates to a delay of  $\geq 20.83 \mu s$ . Not observing this delay corrupts the downloaded data.

Because the compiler has control over the addresses used for software safeload, the addresses assigned to each parameter may differ from the default values in Table 58. The compiler generates a file named compiler\_output.log in the project folder where the SigmaStudio project is stored on the hard drive. In this file, the addresses assigned to the software safeload parameters can be confirmed.

Figure 80 shows an example of the software safeload parameter definitions in an excerpt from the compiler\_output.log file.

The following steps are necessary for executing a software safeload:

1. Confirm that no safeload operation has been executed in the span of the last audio sample.
2. Write the desired data to the data\_SafeLoad, Bit x parameters, starting at data\_SafeLoad, Bit 0, and incrementing, as needed, up to a maximum of five parameters.
3. Write the desired starting target address to the address\_SafeLoad parameter.
4. Write the number of words to be transferred to the num\_SafeLoad parameter. The minimum write length is one word, and the maximum write length is five words.
5. Wait one audio frame for the safeload operation to complete.

```

##### DMO Allocation Summary #####
ModuleMemoryRegions:   Addr:   Module:  Length:
__STACK_MODULE__      0x0    0        16

Address:  Module:
0x0      __STACK__
0x10
0x14      __SafeLoad_Module__
0x19      __SafeLoad_Module__
0x1A      __SafeLoad_Module__
0x1B      EQS300MultiS1
0x1C      EQS300MultiS1
0x1D      EQS300MultiS1
0x1E      EQS300MultiS1
0x1F      EQS300MultiS1
0x20      __DMO_PADDING__

Param:
__STACK__ [16] =0x00000000,0x00000000,0x00000000,0x00000000,
0x00000000,0x00000000,0x00000000,0x00000000,0x00000000,0x00000000,
0x00000000,0x00000000,0x00000000,0x00000000,0x00000000,0x00000000
MP1_DM1 [4] =0x00000000,0x00000000,0x00000008,0x00000000
data_SafeLoad [5] =0x00000000,0x00000000,0x00000000,0x00000000,0x00000000
address_SafeLoad =0x00000000
num_SafeLoad =0x00000000
B2_1 =0x00000000
B1_1 =0x00000000
B0_1 =0x00000000
A2_1 =0x00000000
A1_1 =0x00000000
__DMO_PADDING__ [4] =0x00000000,0x00000000,0x00000000,0x00000000
    
```

Figure 80. Compiler Log Output Excerpt with SafeLoad Module Definitions

11485-083

**Soft Reset Function**

The soft reset function allows the device to enter a state similar to when the hardware RESET pin is connected to ground. All control registers are reset to their default values, except the PLL registers, as follows: Register 0xF000 (PLL\_CTRL0), Register 0xF001 (PLL\_CTRL1), Register 0xF002 (PLL\_CLK\_SRC), Register 0xF003 (PLL\_ENABLE), Register 0xF004 (PLL\_LOCK), Register 0xF005 (MCLK\_OUT), and Register 0xF006 (PLL\_WATCHDOG), as well as the registers related to the panic manager.

Table 59 shows an overview of the register related to the soft reset function. For more details, see the Soft Reset Register section.

**Table 59. Soft Reset Register**

Address	Name	Description
0xF890	SOFT_RESET	Software reset

**PIN DRIVE STRENGTH, SLEW RATE, AND PULL CONFIGURATION**

Every digital output pin has configurable drive strength and slew rate. This allows the current sourcing ability of the driver to be modified to fit the application circuit. In general, higher drive strength is needed to improve signal integrity when driving high frequency clocks over long distances. Lower drive strength can be used for lower frequency clock signals, shorter traces, or in cases where reduced system EMI (electromagnetic interference) is desired. Slew rate can be increased if the edges of the clock signal have rise or fall times that are too long. To achieve adequate signal integrity and minimize electromagnetic emissions, use the drive strength and slew rate settings in combination with good mixed-signal PCB design practices.

**Pin Drive Strength, Slew Rate, and Pull Configuration Registers**

An overview of the registers related to pin drive strength, slew rate, and pull configuration is shown in Table 60. For a more detailed description, see the Hardware Interfacing Registers section.

**Table 60. Pin Drive Strength, Slew Rate, and Pull Configuration Registers**

Address	Register	Description
0xF780	BCLK_IN0_PIN	BCLK input pin drive strength and slew rate (BCLK_IN0)
0xF781	BCLK_IN1_PIN	BCLK input pin drive strength and slew rate (BCLK_IN1)
0xF782	BCLK_IN2_PIN	BCLK input pin drive strength and slew rate (BCLK_IN2)
0xF783	BCLK_IN3_PIN	BCLK input pin drive strength and slew rate (BCLK_IN3)
0xF784	BCLK_OUT0_PIN	BCLK output pin drive strength and slew rate (BCLK_OUT0)
0xF785	BCLK_OUT1_PIN	BCLK output pin drive strength and slew rate (BCLK_OUT1)
0xF786	BCLK_OUT2_PIN	BCLK output pin drive strength and slew rate (BCLK_OUT2)
0xF787	BCLK_OUT3_PIN	BCLK output pin drive strength and slew rate (BCLK_OUT3)
0xF788	LRCLK_IN0_PIN	LRCLK input pin drive strength and slew rate (LRCLK_IN0)
0xF789	LRCLK_IN1_PIN	LRCLK input pin drive strength and slew rate (LRCLK_IN1)
0xF78A	LRCLK_IN2_PIN	LRCLK input pin drive strength and slew rate (LRCLK_IN2)
0xF78B	LRCLK_IN3_PIN	LRCLK input pin drive strength and slew rate (LRCLK_IN3)
0xF78C	LRCLK_OUT0_PIN	LRCLK output pin drive strength and slew rate (LRCLK_OUT0)
0xF78D	LRCLK_OUT1_PIN	LRCLK output pin drive strength and slew rate (LRCLK_OUT1)
0xF78E	LRCLK_OUT2_PIN	LRCLK output pin drive strength and slew rate (LRCLK_OUT2)
0xF78F	LRCLK_OUT3_PIN	LRCLK output pin drive strength and slew rate (LRCLK_OUT3)
0xF790	SDATA_IN0_PIN	SDATA input pin drive strength and slew rate (SDATA_IN0)
0xF791	SDATA_IN1_PIN	SDATA input pin drive strength and slew rate (SDATA_IN1)
0xF792	SDATA_IN2_PIN	SDATA input pin drive strength and slew rate (SDATA_IN2)
0xF793	SDATA_IN3_PIN	SDATA input pin drive strength and slew rate (SDATA_IN3)
0xF794	SDATA_OUT0_PIN	SDATA output pin drive strength and slew rate (SDATA_OUT0)
0xF795	SDATA_OUT1_PIN	SDATA output pin drive strength and slew rate (SDATA_OUT1)
0xF796	SDATA_OUT2_PIN	SDATA output pin drive strength and slew rate (SDATA_OUT2)
0xF797	SDATA_OUT3_PIN	SDATA output pin drive strength and slew rate (SDATA_OUT3)
0xF798	SPDIF_TX_PIN	S/PDIF transmitter pin drive strength and slew rate
0xF799	SCLK_SCL_PIN	SCLK/SCL pin drive strength and slew rate
0xF79A	MISO_SDA_PIN	MISO/SDA pin drive strength and slew rate
0xF79B	SS_PIN	SS/ADDR0 pin drive strength and slew rate
0xF79C	MOSI_ADDR1_PIN	MOSI/ADDR1 pin drive strength and slew rate
0xF79D	SCLK_SCL_M_PIN	SCL_M/SCLK_M/MP2 pin drive strength and slew rate

<b>Address</b>	<b>Register</b>	<b>Description</b>
0xF79E	MISO_SDA_M_PIN	SDA_M/MISO_M/MP3 pin drive strength and slew rate
0xF79F	SS_M_PIN	SS_M/MP0 pin drive strength and slew rate
0xF7A0	MOSI_M_PIN	MOSI_M/MP1 pin drive strength and slew rate
0xF7A1	MP6_PIN	MP6 pin drive strength and slew rate
0xF7A2	MP7_PIN	MP7 pin drive strength and slew rate
0xF7A3	CLKOUT_PIN	CLKOUT pin drive strength and slew rate

## GLOBAL RAM AND CONTROL REGISTER MAP

The complete set of addresses accessible via the slave I<sup>2</sup>C/SPI control port is described in this section. The addresses are divided into two main parts: memory and registers.

### RANDOM ACCESS MEMORY

The ADAU1452 has 1.28 Mb of data (40 kWords storing 32-bit data). The ADAU1451 has 512 kb of data (16 kWords storing 32-bit data). The ADAU1450 has 256 kb of data (8 kWords storing 32-bit data).

The ADAU1452/ADAU1451/ADAU1450 have eight kWords of program memory. Program memory consists of 32 bit words. Op codes for the DSP core are either 32 bits or 64 bits; therefore, program instructions can take up one or two addresses in memory. The program memory has parity bit protection. The panic manager flags parity errors when they are detected.

Program memory can only be written or read when the core is stopped. The program memory is hardware protected so it cannot be accidentally overwritten or corrupted at run time.

The DSP core is able to directly access all memory and registers.

Data memory acts as a storage area for both audio data and signal processing parameters, such as filter coefficients. The data memory has parity bit protection. The panic manager flags parity errors when they are detected. Modulo memory addressing is used in several audio processing algorithms. The boundaries between the fixed and rotating memories are set in SigmaStudio by the compiler, and they require no action on the part of the user.

Data and parameters assignment to the different memory spaces are handled in software. The modulo boundary locations are flexible.

A ROM table (of over seven kWords), containing a set of commonly used constants, can be accessed by the DSP core. This memory is used to increase the efficiency of audio processing algorithm development. The table includes information such as trigonometric tables, including sine, cosine, tangent, and hyperbolic tangent, twiddle factors for frequency domain processing,

real mathematical constants, such as pi and factors of 2, and complex constants. The ROM table is not accessible from the I<sup>2</sup>C or SPI slave control port.

All memory addresses store 32 bits (four bytes) of data. The memory spaces for the ADAU1452 are defined in Table 61. The memory spaces for the ADAU1451 are defined in Table 62. The memory spaces for the ADAU1450 are defined in Table 63.

**Table 61. ADAU1452 Memory Map**

Address Range	Length	Memory	Data-Word Size
0x0000 to 0x4FFF	20480 words	DM0 (Data Memory 0)	32 bits
0x6000 to 0xAFFF	20480 words	DM1 (Data Memory 1)	32 bits
0xC000 to 0xDFFF	8192 words	Program memory	32 bits

**Table 62. ADAU1451 Memory Map**

Address Range	Length	Memory	Data-Word Size
0x0000 to 0x3FFF	16384 words	DM0 (Data Memory 0)	32 bits
0x6000 to 0x9FFF	16384 words	DM1 (Data Memory 1)	32 bits
0xC000 to 0xDFFF	8192 words	Program memory	32 bits

**Table 63. ADAU1450 Memory Map**

Address Range	Length	Memory	Data-Word Size
0x0000 to 0x1FFF	8192 words	DM0 (Data Memory 0)	32 bits
0x6000 to 0x7FFF	8192 words	DM1 (Data Memory 1)	32 bits
0xC000 to 0xDFFF	8192 words	Program memory	32 bits

## CONTROL REGISTERS

All control registers store 16 bits (two bytes) of data. The register map for the [ADAU1452/ADAU1451/ADAU1450](#) is defined in Table 64.

**Table 64. Control Register Summary**

Address	Register Name	Description	Reset	RW
0xF000	PLL_CTRL0	PLL feedback divider	0x0060	RW
0xF001	PLL_CTRL1	PLL prescale divider	0x0000	RW
0xF002	PLL_CLK_SRC	PLL clock source	0x0000	RW
0xF003	PLL_ENABLE	PLL enable	0x0000	RW
0xF004	PLL_LOCK	PLL lock	0x0000	R
0xF005	MCLK_OUT	CLKOUT control	0x0000	RW
0xF006	PLL_WATCHDOG	Analog PLL watchdog control	0x0001	RW
0xF020	CLK_GEN1_M	Denominator (M) for Clock Generator 1	0x0006	RW
0xF021	CLK_GEN1_N	Numerator (N) for Clock Generator 1	0x0001	RW
0xF022	CLK_GEN2_M	Denominator (M) for Clock Generator 2	0x0009	RW
0xF023	CLK_GEN2_N	Numerator (N) for Clock Generator 2	0x0001	RW
0xF024	CLK_GEN3_M	Denominator (M) for Clock Generator 3	0x0000	RW
0xF025	CLK_GEN3_N	Numerator for (N) Clock Generator 3	0x0000	RW
0xF026	CLK_GEN3_SRC	Input Reference for Clock Generator 3	0x000E	RW
0xF027	CLK_GEN3_LOCK	Lock Bit for Clock Generator 3 input reference	0x0000	R
0xF050	POWER_ENABLE0	Power Enable 0	0x0000	RW
0xF051	POWER_ENABLE1	Power Enable 1	0x0000	RW
0xF100	ASRC_INPUT0	ASRC input selector (ASRC 0, Channel 0 and Channel 1)	0x0000	RW
0xF101	ASRC_INPUT1	ASRC input selector (ASRC 1, Channel 2 and Channel 3)	0x0000	RW
0xF102	ASRC_INPUT2	ASRC input selector (ASRC 2, Channel 4 and Channel 5)	0x0000	RW
0xF103	ASRC_INPUT3	ASRC input selector (ASRC 3, Channel 6 and Channel 7)	0x0000	RW
0xF104	ASRC_INPUT4	ASRC input selector (ASRC 4, Channel 8 and Channel 9)	0x0000	RW
0xF105	ASRC_INPUT5	ASRC input selector (ASRC 5, Channel 10 and Channel 11)	0x0000	RW
0xF106	ASRC_INPUT6	ASRC input selector (ASRC 6, Channel 12 and Channel 13)	0x0000	RW
0xF107	ASRC_INPUT7	ASRC input selector (ASRC 7, Channel 14 and Channel 15)	0x0000	RW
0xF140	ASRC_OUT_RATE0	ASRC output rate (ASRC 0, Channel 0 and Channel 1)	0x0000	RW
0xF141	ASRC_OUT_RATE1	ASRC output rate (ASRC 1, Channel 2 and Channel 3)	0x0000	RW
0xF142	ASRC_OUT_RATE2	ASRC output rate (ASRC 2, Channel 4 and Channel 5)	0x0000	RW
0xF143	ASRC_OUT_RATE3	ASRC output rate (ASRC 3, Channel 6 and Channel 7)	0x0000	RW
0xF144	ASRC_OUT_RATE4	ASRC output rate (ASRC 4, Channel 8 and Channel 9)	0x0000	RW
0xF145	ASRC_OUT_RATE5	ASRC output rate (ASRC 5, Channel 10 and Channel 11)	0x0000	RW
0xF146	ASRC_OUT_RATE6	ASRC output rate (ASRC 6, Channel 12 and Channel 13)	0x0000	RW
0xF147	ASRC_OUT_RATE7	ASRC output rate (ASRC 7, Channel 14 and Channel 15)	0x0000	RW
0xF180	SOUT_SOURCE0	Source of data for serial output ports (Channel 0 and Channel 1)	0x0000	RW
0xF181	SOUT_SOURCE1	Source of data for serial output ports (Channel 2 and Channel 3)	0x0000	RW
0xF182	SOUT_SOURCE2	Source of data for serial output ports (Channel 4 and Channel 5)	0x0000	RW
0xF183	SOUT_SOURCE3	Source of data for serial output ports (Channel 6 and Channel 7)	0x0000	RW
0xF184	SOUT_SOURCE4	Source of data for serial output ports (Channel 8 and Channel 9)	0x0000	RW
0xF185	SOUT_SOURCE5	Source of data for serial output ports (Channel 10 and Channel 11)	0x0000	RW
0xF186	SOUT_SOURCE6	Source of data for serial output ports (Channel 12 and Channel 13)	0x0000	RW
0xF187	SOUT_SOURCE7	Source of data for serial output ports (Channel 14 and Channel 15)	0x0000	RW
0xF188	SOUT_SOURCE8	Source of data for serial output ports (Channel 16 and Channel 17)	0x0000	RW
0xF189	SOUT_SOURCE9	Source of data for serial output ports (Channel 18 and Channel 19)	0x0000	RW
0xF18A	SOUT_SOURCE10	Source of data for serial output ports (Channel 20 and Channel 21)	0x0000	RW
0xF18B	SOUT_SOURCE11	Source of data for serial output ports (Channel 22 and Channel 23)	0x0000	RW
0xF18C	SOUT_SOURCE12	Source of data for serial output ports (Channel 24 and Channel 25)	0x0000	RW
0xF18D	SOUT_SOURCE13	Source of data for serial output ports (Channel 26 and Channel 27)	0x0000	RW
0xF18E	SOUT_SOURCE14	Source of data for serial output ports (Channel 28 and Channel 29)	0x0000	RW
0xF18F	SOUT_SOURCE15	Source of data for serial output ports (Channel 30 and Channel 31)	0x0000	RW
0xF190	SOUT_SOURCE16	Source of data for serial output ports (Channel 32 and Channel 33)	0x0000	RW



Address	Register Name	Description	Reset	RW
0xF191	SOUT_SOURCE17	Source of data for serial output ports (Channel 34 and Channel 35)	0x0000	RW
0xF192	SOUT_SOURCE18	Source of data for serial output ports (Channel 36 and Channel 37)	0x0000	RW
0xF193	SOUT_SOURCE19	Source of data for serial output ports (Channel 38 and Channel 39)	0x0000	RW
0xF194	SOUT_SOURCE20	Source of data for serial output ports (Channel 40 and Channel 41)	0x0000	RW
0xF195	SOUT_SOURCE21	Source of data for serial output ports (Channel 42 and Channel 43)	0x0000	RW
0xF196	SOUT_SOURCE22	Source of data for serial output ports (Channel 44 and Channel 45)	0x0000	RW
0xF197	SOUT_SOURCE23	Source of data for serial output ports (Channel 46 and Channel 47)	0x0000	RW
0xF1C0	SPDIFTX_INPUT	S/PDIF transmitter data selector	0x0000	RW
0xF200	SERIAL_BYTE_0_0	Serial Port Control 0 (SDATA_IN0)	0x0000	RW
0xF201	SERIAL_BYTE_0_1	Serial Port Control 1 (SDATA_IN0)	0x0002	RW
0xF204	SERIAL_BYTE_1_0	Serial Port Control 0 (SDATA_IN1)	0x0000	RW
0xF205	SERIAL_BYTE_1_1	Serial Port Control 1 (SDATA_IN1)	0x0002	RW
0xF208	SERIAL_BYTE_2_0	Serial Port Control 0 (SDATA_IN2)	0x0000	RW
0xF209	SERIAL_BYTE_2_1	Serial Port Control 1 (SDATA_IN2)	0x0002	RW
0xF20C	SERIAL_BYTE_3_0	Serial Port Control 0 (SDATA_IN3)	0x0000	RW
0xF20D	SERIAL_BYTE_3_1	Serial Port Control 1 (SDATA_IN3)	0x0002	RW
0xF210	SERIAL_BYTE_4_0	Serial Port Control 0 (SDATA_OUT0)	0x0000	RW
0xF211	SERIAL_BYTE_4_1	Serial Port Control 1 (SDATA_OUT0)	0x0002	RW
0xF214	SERIAL_BYTE_5_0	Serial Port Control 0 (SDATA_OUT1)	0x0000	RW
0xF215	SERIAL_BYTE_5_1	Serial Port Control 1 (SDATA_OUT1)	0x0002	RW
0xF218	SERIAL_BYTE_6_0	Serial Port Control 0 (SDATA_OUT2)	0x0000	RW
0xF219	SERIAL_BYTE_6_1	Serial Port Control 1 (SDATA_OUT2)	0x0002	RW
0xF21C	SERIAL_BYTE_7_0	Serial Port Control 0 (SDATA_OUT3)	0x0000	RW
0xF21D	SERIAL_BYTE_7_1	Serial Port Control 1 (SDATA_OUT3)	0x0002	RW
0xF300	FTDM_IN0	FTDM mapping for the serial inputs (Channel 32, Bits[31:24])	0x0000	RW
0xF301	FTDM_IN1	FTDM mapping for the serial inputs (Channel 32, Bits[23:16])	0x0000	RW
0xF302	FTDM_IN2	FTDM mapping for the serial inputs (Channel 32, Bits[15:8])	0x0000	RW
0xF303	FTDM_IN3	FTDM mapping for the serial inputs (Channel 32, Bits[7:0])	0x0000	RW
0xF304	FTDM_IN4	FTDM mapping for the serial inputs (Channel 33, Bits[31:24])	0x0000	RW
0xF305	FTDM_IN5	FTDM mapping for the serial inputs (Channel 33, Bits[23:16])	0x0000	RW
0xF306	FTDM_IN6	FTDM mapping for the serial inputs (Channel 33, Bits[15:8])	0x0000	RW
0xF307	FTDM_IN7	FTDM mapping for the serial inputs (Channel 33, Bits[7:0])	0x0000	RW
0xF308	FTDM_IN8	FTDM mapping for the serial inputs (Channel 34, Bits[31:24])	0x0000	RW
0xF309	FTDM_IN9	FTDM mapping for the serial inputs (Channel 34, Bits[23:16])	0x0000	RW
0xF30A	FTDM_IN10	FTDM mapping for the serial inputs (Channel 34, Bits[15:8])	0x0000	RW
0xF30B	FTDM_IN11	FTDM mapping for the serial inputs (Channel 34, Bits[7:0])	0x0000	RW
0xF30C	FTDM_IN12	FTDM mapping for the serial inputs (Channel 35, Bits[31:24])	0x0000	RW
0xF30D	FTDM_IN13	FTDM mapping for the serial inputs (Channel 35, Bits[23:16])	0x0000	RW
0xF30E	FTDM_IN14	FTDM mapping for the serial inputs (Channel 35, Bits[15:8])	0x0000	RW
0xF30F	FTDM_IN15	FTDM mapping for the serial inputs (Channel 35, Bits[7:0])	0x0000	RW
0xF310	FTDM_IN16	FTDM mapping for the serial inputs (Channel 36, Bits[31:24])	0x0000	RW
0xF311	FTDM_IN17	FTDM mapping for the serial inputs (Channel 36, Bits[23:16])	0x0000	RW
0xF312	FTDM_IN18	FTDM mapping for the serial inputs (Channel 36, Bits[15:8])	0x0000	RW
0xF313	FTDM_IN19	FTDM mapping for the serial inputs (Channel 36, Bits[7:0])	0x0000	RW
0xF314	FTDM_IN20	FTDM mapping for the serial inputs (Channel 37, Bits[31:24])	0x0000	RW
0xF315	FTDM_IN21	FTDM mapping for the serial inputs (Channel 37, Bits[23:16])	0x0000	RW
0xF316	FTDM_IN22	FTDM mapping for the serial inputs (Channel 37, Bits[15:8])	0x0000	RW
0xF317	FTDM_IN23	FTDM mapping for the serial inputs (Channel 37, Bits[7:0])	0x0000	RW
0xF318	FTDM_IN24	FTDM mapping for the serial inputs (Channel 38, Bits[31:24])	0x0000	RW
0xF319	FTDM_IN25	FTDM mapping for the serial inputs (Channel 38, Bits[23:16])	0x0000	RW
0xF31A	FTDM_IN26	FTDM mapping for the serial inputs (Channel 38, Bits[15:8])	0x0000	RW
0xF31B	FTDM_IN27	FTDM mapping for the serial inputs (Channel 38, Bits[7:0])	0x0000	RW
0xF31C	FTDM_IN28	FTDM mapping for the serial inputs (Channel 39, Bits[31:24])	0x0000	RW
0xF31D	FTDM_IN29	FTDM mapping for the serial inputs (Channel 39, Bits[23:16])	0x0000	RW

Address	Register Name	Description	Reset	RW
0xF31E	FTDM_IN30	FTDM mapping for the serial inputs (Channel 39, Bits[15:8])	0x0000	RW
0xF31F	FTDM_IN31	FTDM mapping for the serial inputs (Channel 39, Bits[7:0])	0x0000	RW
0xF320	FTDM_IN32	FTDM mapping for the serial inputs (Channel 40, Bits[31:24])	0x0000	RW
0xF321	FTDM_IN33	FTDM mapping for the serial inputs (Channel 40, Bits[23:16])	0x0000	RW
0xF322	FTDM_IN34	FTDM mapping for the serial inputs (Channel 40, Bits[15:8])	0x0000	RW
0xF323	FTDM_IN35	FTDM mapping for the serial inputs (Channel 40, Bits[7:0])	0x0000	RW
0xF324	FTDM_IN36	FTDM mapping for the serial inputs (Channel 41, Bits[31:24])	0x0000	RW
0xF325	FTDM_IN37	FTDM mapping for the serial inputs (Channel 41, Bits[23:16])	0x0000	RW
0xF326	FTDM_IN38	FTDM mapping for the serial inputs (Channel 41, Bits[15:8])	0x0000	RW
0xF327	FTDM_IN39	FTDM mapping for the serial inputs (Channel 41, Bits[7:0])	0x0000	RW
0xF328	FTDM_IN40	FTDM mapping for the serial inputs (Channel 42, Bits[31:24])	0x0000	RW
0xF329	FTDM_IN41	FTDM mapping for the serial inputs (Channel 42, Bits[23:16])	0x0000	RW
0xF32A	FTDM_IN42	FTDM mapping for the serial inputs (Channel 42, Bits[15:8])	0x0000	RW
0xF32B	FTDM_IN43	FTDM mapping for the serial inputs (Channel 42, Bits[7:0])	0x0000	RW
0xF32C	FTDM_IN44	FTDM mapping for the serial inputs (Channel 43, Bits[31:24])	0x0000	RW
0xF32D	FTDM_IN45	FTDM mapping for the serial inputs (Channel 43, Bits[23:16])	0x0000	RW
0xF32E	FTDM_IN46	FTDM mapping for the serial inputs (Channel 43, Bits[15:8])	0x0000	RW
0xF32F	FTDM_IN47	FTDM mapping for the serial inputs (Channel 43, Bits[7:0])	0x0000	RW
0xF330	FTDM_IN48	FTDM mapping for the serial inputs (Channel 44, Bits[31:24])	0x0000	RW
0xF331	FTDM_IN49	FTDM mapping for the serial inputs (Channel 44, Bits[23:16])	0x0000	RW
0xF332	FTDM_IN50	FTDM mapping for the serial inputs (Channel 44, Bits[15:8])	0x0000	RW
0xF333	FTDM_IN51	FTDM mapping for the serial inputs (Channel 44, Bits[7:0])	0x0000	RW
0xF334	FTDM_IN52	FTDM mapping for the serial inputs (Channel 45, Bits[31:24])	0x0000	RW
0xF335	FTDM_IN53	FTDM mapping for the serial inputs (Channel 45, Bits[23:16])	0x0000	RW
0xF336	FTDM_IN54	FTDM mapping for the serial inputs (Channel 45, Bits[15:8])	0x0000	RW
0xF337	FTDM_IN55	FTDM mapping for the serial inputs (Channel 45, Bits[7:0])	0x0000	RW
0xF338	FTDM_IN56	FTDM mapping for the serial inputs (Channel 46, Bits[31:24])	0x0000	RW
0xF339	FTDM_IN57	FTDM mapping for the serial inputs (Channel 46, Bits[23:16])	0x0000	RW
0xF33A	FTDM_IN58	FTDM mapping for the serial inputs (Channel 46, Bits[15:8])	0x0000	RW
0xF33B	FTDM_IN59	FTDM mapping for the serial inputs (Channel 46, Bits[7:0])	0x0000	RW
0xF33C	FTDM_IN60	FTDM mapping for the serial inputs (Channel 47, Bits[31:24])	0x0000	RW
0xF33D	FTDM_IN61	FTDM mapping for the serial inputs (Channel 47, Bits[23:16])	0x0000	RW
0xF33E	FTDM_IN62	FTDM mapping for the serial inputs (Channel 47, Bits[15:8])	0x0000	RW
0xF33F	FTDM_IN63	FTDM mapping for the serial inputs (Channel 47, Bits[7:0])	0x0000	RW
0xF380	FTDM_OUT0	FTDM mapping for the serial outputs (Port 2, Channel 0, Bits[31:24])	0x0000	RW
0xF381	FTDM_OUT1	FTDM mapping for the serial outputs (Port 2, Channel 0, Bits[23:16])	0x0000	RW
0xF382	FTDM_OUT2	FTDM mapping for the serial outputs (Port 2, Channel 0, Bits[15:8])	0x0000	RW
0xF383	FTDM_OUT3	FTDM mapping for the serial outputs (Port 2, Channel 0, Bits[7:0])	0x0000	RW
0xF384	FTDM_OUT4	FTDM mapping for the serial outputs (Port 2, Channel 1, Bits[31:24])	0x0000	RW
0xF385	FTDM_OUT5	FTDM mapping for the serial outputs (Port 2, Channel 1, Bits[23:16])	0x0000	RW
0xF386	FTDM_OUT6	FTDM mapping for the serial outputs (Port 2, Channel 1, Bits[15:8])	0x0000	RW
0xF387	FTDM_OUT7	FTDM mapping for the serial outputs (Port 2, Channel 1, Bits[7:0])	0x0000	RW
0xF388	FTDM_OUT8	FTDM mapping for the serial outputs (Port 2, Channel 2, Bits[31:24])	0x0000	RW
0xF389	FTDM_OUT9	FTDM mapping for the serial outputs (Port 2, Channel 2, Bits[23:16])	0x0000	RW
0xF38A	FTDM_OUT10	FTDM mapping for the serial outputs (Port 2, Channel 2, Bits[15:8])	0x0000	RW
0xF38B	FTDM_OUT11	FTDM mapping for the serial outputs (Port 2, Channel 2, Bits[7:0])	0x0000	RW
0xF38C	FTDM_OUT12	FTDM mapping for the serial outputs (Port 2, Channel 3, Bits[31:24])	0x0000	RW
0xF38D	FTDM_OUT13	FTDM mapping for the serial outputs (Port 2, Channel 3, Bits[23:16])	0x0000	RW
0xF38E	FTDM_OUT14	FTDM mapping for the serial outputs (Port 2, Channel 3, Bits[15:8])	0x0000	RW
0xF38F	FTDM_OUT15	FTDM mapping for the serial outputs (Port 2, Channel 3, Bits[7:0])	0x0000	RW
0xF390	FTDM_OUT16	FTDM mapping for the serial outputs (Port 2, Channel 4, Bits[31:24])	0x0000	RW
0xF391	FTDM_OUT17	FTDM mapping for the serial outputs (Port 2, Channel 4, Bits[23:16])	0x0000	RW
0xF392	FTDM_OUT18	FTDM mapping for the serial outputs (Port 2, Channel 4, Bits[15:8])	0x0000	RW
0xF393	FTDM_OUT19	FTDM mapping for the serial outputs (Port 2, Channel 4, Bits[7:0])	0x0000	RW

Address	Register Name	Description	Reset	RW
0xF394	FTDM_OUT20	FTDM mapping for the serial outputs (Port 2, Channel 5, Bits[31:24])	0x0000	RW
0xF395	FTDM_OUT21	FTDM mapping for the serial outputs (Port 2, Channel 5, Bits[23:16])	0x0000	RW
0xF396	FTDM_OUT22	FTDM mapping for the serial outputs (Port 2, Channel 5, Bits[15:8])	0x0000	RW
0xF397	FTDM_OUT23	FTDM mapping for the serial outputs (Port 2, Channel 5, Bits[7:0])	0x0000	RW
0xF398	FTDM_OUT24	FTDM mapping for the serial outputs (Port 2, Channel 6, Bits[31:24])	0x0000	RW
0xF399	FTDM_OUT25	FTDM mapping for the serial outputs (Port 2, Channel 6, Bits[23:16])	0x0000	RW
0xF39A	FTDM_OUT26	FTDM mapping for the serial outputs (Port 2, Channel 6, Bits[15:8])	0x0000	RW
0xF39B	FTDM_OUT27	FTDM mapping for the serial outputs (Port 2, Channel 6, Bits[7:0])	0x0000	RW
0xF39C	FTDM_OUT28	FTDM mapping for the serial outputs (Port 2, Channel 7, Bits[31:24])	0x0000	RW
0xF39D	FTDM_OUT29	FTDM mapping for the serial outputs (Port 2, Channel 7, Bits[23:16])	0x0000	RW
0xF39E	FTDM_OUT30	FTDM mapping for the serial outputs (Port 2, Channel 7, Bits[15:8])	0x0000	RW
0xF39F	FTDM_OUT31	FTDM mapping for the serial outputs (Port 2, Channel 7, Bits[7:0])	0x0000	RW
0xF3A0	FTDM_OUT32	FTDM mapping for the serial outputs (Port 3, Channel 0, Bits[31:24])	0x0000	RW
0xF3A1	FTDM_OUT33	FTDM mapping for the serial outputs (Port 3, Channel 0, Bits[23:16])	0x0000	RW
0xF3A2	FTDM_OUT34	FTDM mapping for the serial outputs (Port 3, Channel 0, Bits[15:8])	0x0000	RW
0xF3A3	FTDM_OUT35	FTDM mapping for the serial outputs (Port 3, Channel 0, Bits[7:0])	0x0000	RW
0xF3A4	FTDM_OUT36	FTDM mapping for the serial outputs (Port 3, Channel 1, Bits[31:24])	0x0000	RW
0xF3A5	FTDM_OUT37	FTDM mapping for the serial outputs (Port 3, Channel 1, Bits[23:16])	0x0000	RW
0xF3A6	FTDM_OUT38	FTDM mapping for the serial outputs (Port 3, Channel 1, Bits[15:8])	0x0000	RW
0xF3A7	FTDM_OUT39	FTDM mapping for the serial outputs (Port 3, Channel 1, Bits[7:0])	0x0000	RW
0xF3A8	FTDM_OUT40	FTDM mapping for the serial outputs (Port 3, Channel 2, Bits[31:24])	0x0000	RW
0xF3A9	FTDM_OUT41	FTDM mapping for the serial outputs (Port 3, Channel 2, Bits[23:16])	0x0000	RW
0xF3AA	FTDM_OUT42	FTDM mapping for the serial outputs (Port 3, Channel 2, Bits[15:8])	0x0000	RW
0xF3AB	FTDM_OUT43	FTDM mapping for the serial outputs (Port 3, Channel 2, Bits[7:0])	0x0000	RW
0xF3AC	FTDM_OUT44	FTDM mapping for the serial outputs (Port 3, Channel 3, Bits[31:24])	0x0000	RW
0xF3AD	FTDM_OUT45	FTDM mapping for the serial outputs (Port 3, Channel 3, Bits[23:16])	0x0000	RW
0xF3AE	FTDM_OUT46	FTDM mapping for the serial outputs (Port 3, Channel 3, Bits[15:8])	0x0000	RW
0xF3AF	FTDM_OUT47	FTDM mapping for the serial outputs (Port 3, Channel 3, Bits[7:0])	0x0000	RW
0xF3B0	FTDM_OUT48	FTDM mapping for the serial outputs (Port 3, Channel 4, Bits[31:24])	0x0000	RW
0xF3B1	FTDM_OUT49	FTDM mapping for the serial outputs (Port 3, Channel 4, Bits[23:16])	0x0000	RW
0xF3B2	FTDM_OUT50	FTDM mapping for the serial outputs (Port 3, Channel 4, Bits[15:8])	0x0000	RW
0xF3B3	FTDM_OUT51	FTDM mapping for the serial outputs (Port 3, Channel 4, Bits[7:0])	0x0000	RW
0xF3B4	FTDM_OUT52	FTDM mapping for the serial outputs (Port 3, Channel 5, Bits[31:24])	0x0000	RW
0xF3B5	FTDM_OUT53	FTDM mapping for the serial outputs (Port 3, Channel 5, Bits[23:16])	0x0000	RW
0xF3B6	FTDM_OUT54	FTDM mapping for the serial outputs (Port 3, Channel 5, Bits[15:8])	0x0000	RW
0xF3B7	FTDM_OUT55	FTDM mapping for the serial outputs (Port 3, Channel 5, Bits[7:0])	0x0000	RW
0xF3B8	FTDM_OUT56	FTDM mapping for the serial outputs (Port 3, Channel 6, Bits[31:24])	0x0000	RW
0xF3B9	FTDM_OUT57	FTDM mapping for the serial outputs (Port 3, Channel 6, Bits[23:16])	0x0000	RW
0xF3BA	FTDM_OUT58	FTDM mapping for the serial outputs (Port 3, Channel 6, Bits[15:8])	0x0000	RW
0xF3BB	FTDM_OUT59	FTDM mapping for the serial outputs (Port 3, Channel 6, Bits[7:0])	0x0000	RW
0xF3BC	FTDM_OUT60	FTDM mapping for the serial outputs (Port 3, Channel 7, Bits[31:24])	0x0000	RW
0xF3BD	FTDM_OUT61	FTDM mapping for the serial outputs (Port 3, Channel 7, Bits[23:16])	0x0000	RW
0xF3BE	FTDM_OUT62	FTDM mapping for the serial outputs (Port 3, Channel 7, Bits[15:8])	0x0000	RW
0xF3BF	FTDM_OUT63	FTDM mapping for the serial outputs (Port 3, Channel 7, Bits[7:0])	0x0000	RW
0xF400	HIBERNATE	Hibernate setting	0x0000	RW
0xF401	START_PULSE	Start pulse selection	0x0002	RW
0xF402	START_CORE	Instruction to start the core	0x0000	RW
0xF403	KILL_CORE	Instruction to stop the core	0x0000	RW
0xF404	START_ADDRESS	Start address of the program	0x0000	RW
0xF405	CORE_STATUS	Core status	0x0000	R
0xF421	PANIC_CLEAR	Clear the panic manager	0x0000	RW
0xF422	PANIC_PARITY_MASK	Panic parity	0x0003	RW
0xF423	PANIC_SOFTWARE_MASK	Panic Mask 0	0x0000	RW
0xF424	PANIC_WD_MASK	Panic Mask 1	0x0000	RW

Address	Register Name	Description	Reset	RW
0xF425	PANIC_STACK_MASK	Panic Mask 2	0x0000	RW
0xF426	PANIC_LOOP_MASK	Panic Mask 3	0x0000	RW
0xF427	PANIC_FLAG	Panic flag	0x0000	R
0xF428	PANIC_CODE	Panic code	0x0000	R
0xF432	EXECUTE_COUNT	Execute stage error program count	0x0000	R
0xF443	WATCHDOG_MAXCOUNT	Watchdog maximum count	0x0000	RW
0xF444	WATCHDOG_PRESCALE	Watchdog prescale	0x0000	RW
0xF450	BLOCKINT_EN	Enable block interrupts	0x0000	RW
0xF451	BLOCKINT_VALUE	Value for the block interrupt counter	0x0000	RW
0xF460	PROG_CNTR0	Program counter, Bits[23:16]	0x0000	R
0xF461	PROG_CNTR1	Program counter, Bits[15:0]	0x0000	R
0xF462	PROG_CNTR_CLEAR	Program counter clear	0x0000	RW
0xF463	PROG_CNTR_LENGTH0	Program counter length, Bits[23:16]	0x0000	R
0xF464	PROG_CNTR_LENGTH1	Program counter length, Bits[15:0]	0x0000	R
0xF465	PROG_CNTR_MAXLENGTH0	Program counter max length, Bits[23:16]	0x0000	R
0xF466	PROG_CNTR_MAXLENGTH1	Program counter max length, Bits[15:0]	0x0000	R
0xF510	MP0_MODE	Multipurpose pin mode (SS_M/MP0)	0x0000	RW
0xF511	MP1_MODE	Multipurpose pin mode (MOSI_M/MP1)	0x0000	RW
0xF512	MP2_MODE	Multipurpose pin mode (SCL_M/SCLK_M/MP2)	0x0000	RW
0xF513	MP3_MODE	Multipurpose pin mode (SDA_M,MISO_M/MP3)	0x0000	RW
0xF514	MP4_MODE	Multipurpose pin mode (LRCLK_OUT0/MP4)	0x0000	RW
0xF515	MP5_MODE	Multipurpose pin mode (LRCLK_OUT1/MP5)	0x0000	RW
0xF516	MP6_MODE	Multipurpose pin mode (MP6)	0x0000	RW
0xF517	MP7_MODE	Multipurpose pin mode (MP7)	0x0000	RW
0xF518	MP8_MODE	Multipurpose pin mode (LRCLK_OUT2/MP8)	0x0000	RW
0xF519	MP9_MODE	Multipurpose pin mode (LRCLK_OUT3/MP9)	0x0000	RW
0xF51A	MP10_MODE	Multipurpose pin mode (LRCLK_IN0/MP10)	0x0000	RW
0xF51B	MP11_MODE	Multipurpose pin mode (LRCLK_IN1/MP11)	0x0000	RW
0xF51C	MP12_MODE	Multipurpose pin mode (LRCLK_IN2/MP12)	0x0000	RW
0xF51D	MP13_MODE	Multipurpose pin mode (LRCLK_IN3/MP13)	0x0000	RW
0xF520	MP0_WRITE	Multipurpose pin write value (SS_M/MP0)	0x0000	RW
0xF521	MP1_WRITE	Multipurpose pin write value (MOSI_M/MP1)	0x0000	RW
0xF522	MP2_WRITE	Multipurpose pin write value SCL_M/SCLK_M/MP2)	0x0000	RW
0xF523	MP3_WRITE	Multipurpose pin write value (SDA_M,MISO_M/MP3)	0x0000	RW
0xF524	MP4_WRITE	Multipurpose pin write value (LRCLK_OUT0/MP4)	0x0000	RW
0xF525	MP5_WRITE	Multipurpose pin write value (LRCLK_OUT1/MP5)	0x0000	RW
0xF526	MP6_WRITE	Multipurpose pin write value (MP6)	0x0000	RW
0xF527	MP7_WRITE	Multipurpose pin write value (MP7)	0x0000	RW
0xF528	MP8_WRITE	Multipurpose pin write value (LRCLK_OUT2/MP8)	0x0000	RW
0xF529	MP9_WRITE	Multipurpose pin write value (LRCLK_OUT3/MP9)	0x0000	RW
0xF52A	MP10_WRITE	Multipurpose pin write value (LRCLK_IN0/MP10)	0x0000	RW
0xF52B	MP11_WRITE	Multipurpose pin write value (LRCLK_IN1/MP11)	0x0000	RW
0xF52C	MP12_WRITE	Multipurpose pin write value (LRCLK_IN2/MP12)	0x0000	RW
0xF52D	MP13_WRITE	Multipurpose pin write value (LRCLK_IN3/MP13)	0x0000	RW
0xF530	MP0_READ	Multipurpose pin read value (SS_M/MP0)	0x0000	R
0xF531	MP1_READ	Multipurpose pin read value (MOSI_M/MP1)	0x0000	R
0xF532	MP2_READ	Multipurpose pin read value (SCL_M/SCLK_M/MP2)	0x0000	R
0xF533	MP3_READ	Multipurpose pin read value (SDA_M,MISO_M/MP3)	0x0000	R
0xF534	MP4_READ	Multipurpose pin read value (LRCLK_OUT0/MP4)	0x0000	R
0xF535	MP5_READ	Multipurpose pin read value (LRCLK_OUT1/MP5)	0x0000	R
0xF536	MP6_READ	Multipurpose pin read value (MP6)	0x0000	R
0xF537	MP7_READ	Multipurpose pin read value (MP7)	0x0000	R
0xF538	MP8_READ	Multipurpose pin read value (LRCLK_OUT2/MP8)	0x0000	R
0xF539	MP9_READ	Multipurpose pin read value (LRCLK_OUT3/MP9)	0x0000	R

Address	Register Name	Description	Reset	RW
0xF53A	MP10_READ	Multipurpose pin read value (LRCLK_IN0/MP10)	0x0000	R
0xF53B	MP11_READ	Multipurpose pin read value (LRCLK_IN1/MP11)	0x0000	R
0xF53C	MP12_READ	Multipurpose pin read value (LRCLK_IN2/MP12)	0x0000	R
0xF53D	MP13_READ	Multipurpose pin read value (LRCLK_IN3/MP13)	0x0000	R
0xF560	DMIC_CTRL0	Digital PDM microphone control (Channel 0 and Channel 1)	0x4000	RW
0xF561	DMIC_CTRL1	Digital PDM microphone control (Channel 2 and Channel 3)	0x4000	RW
0xF580	ASRC_LOCK	ASRC lock status	0x0000	R
0xF581	ASRC_MUTE	ASRC mute	0x0000	RW
0xF582	ASRC0_RATIO	ASRC ratio (ASRC 0, Channel 0 and Channel 1)	0x0000	R
0xF583	ASRC1_RATIO	ASRC ratio (ASRC 1, Channel 2 and Channel 3)	0x0000	R
0xF584	ASRC2_RATIO	ASRC ratio (ASRC 2, Channel 4 and Channel 5)	0x0000	R
0xF585	ASRC3_RATIO	ASRC ratio (ASRC 3, Channel 6 and Channel 7)	0x0000	R
0xF586	ASRC4_RATIO	ASRC ratio (ASRC 4, Channel 8 and Channel 9)	0x0000	R
0xF587	ASRC5_RATIO	ASRC ratio (ASRC 5, Channel 10 and Channel 11)	0x0000	R
0xF588	ASRC6_RATIO	ASRC ratio (ASRC 6, Channel 12 and Channel 13)	0x0000	R
0xF589	ASRC7_RATIO	ASRC ratio (ASRC 7, Channel 14 and Channel 15)	0x0000	R
0xF5A0	ADC_READ0	Auxiliary ADC read value (AUXADC0)	0x0000	R
0xF5A1	ADC_READ1	Auxiliary ADC read value (AUXADC1)	0x0000	R
0xF5A2	ADC_READ2	Auxiliary ADC read value (AUXADC2)	0x0000	R
0xF5A3	ADC_READ3	Auxiliary ADC read value (AUXADC3)	0x0000	R
0xF5A4	ADC_READ4	Auxiliary ADC read value (AUXADC4)	0x0000	R
0xF5A5	ADC_READ5	Auxiliary ADC read value (AUXADC5)	0x0000	R
0xF600	SPDIF_LOCK_DET	S/PDIF receiver lock bit detection	0x0000	R
0xF601	SPDIF_RX_CTRL	S/PDIF receiver control	0x0000	RW
0xF602	SPDIF_RX_DECODE	Decoded signals from the S/PDIF receiver	0x0000	R
0xF603	SPDIF_RX_COMPRMODE	Compression mode from the S/PDIF receiver	0x0000	R
0xF604	SPDIF_RESTART	Automatically resume S/PDIF receiver audio input	0x0000	RW
0xF605	SPDIF_LOSS_OF_LOCK	S/PDIF receiver loss of lock detection	0x0000	R
0xF608	SPDIF_AUX_EN	S/PDIF receiver auxiliary outputs enable	0x0000	RW
0xF60F	SPDIF_RX_AUXBIT_READY	S/PDIF receiver auxiliary bits ready flag	0x0000	R
0xF610	SPDIF_RX_CS_LEFT_0	S/PDIF receiver channel status bits (left)	0x0000	R
0xF611	SPDIF_RX_CS_LEFT_1	S/PDIF receiver channel status bits (left)	0x0000	R
0xF612	SPDIF_RX_CS_LEFT_2	S/PDIF receiver channel status bits (left)	0x0000	R
0xF613	SPDIF_RX_CS_LEFT_3	S/PDIF receiver channel status bits (left)	0x0000	R
0xF614	SPDIF_RX_CS_LEFT_4	S/PDIF receiver channel status bits (left)	0x0000	R
0xF615	SPDIF_RX_CS_LEFT_5	S/PDIF receiver channel status bits (left)	0x0000	R
0xF616	SPDIF_RX_CS_LEFT_6	S/PDIF receiver channel status bits (left)	0x0000	R
0xF617	SPDIF_RX_CS_LEFT_7	S/PDIF receiver channel status bits (left)	0x0000	R
0xF618	SPDIF_RX_CS_LEFT_8	S/PDIF receiver channel status bits (left)	0x0000	R
0xF619	SPDIF_RX_CS_LEFT_9	S/PDIF receiver channel status bits (left)	0x0000	R
0xF61A	SPDIF_RX_CS_LEFT_10	S/PDIF receiver channel status bits (left)	0x0000	R
0xF61B	SPDIF_RX_CS_LEFT_11	S/PDIF receiver channel status bits (left)	0x0000	R
0xF620	SPDIF_RX_CS_RIGHT_0	S/PDIF receiver channel status bits (right)	0x0000	R
0xF621	SPDIF_RX_CS_RIGHT_1	S/PDIF receiver channel status bits (right)	0x0000	R
0xF622	SPDIF_RX_CS_RIGHT_2	S/PDIF receiver channel status bits (right)	0x0000	R
0xF623	SPDIF_RX_CS_RIGHT_3	S/PDIF receiver channel status bits (right)	0x0000	R
0xF624	SPDIF_RX_CS_RIGHT_4	S/PDIF receiver channel status bits (right)	0x0000	R
0xF625	SPDIF_RX_CS_RIGHT_5	S/PDIF receiver channel status bits (right)	0x0000	R
0xF626	SPDIF_RX_CS_RIGHT_6	S/PDIF receiver channel status bits (right)	0x0000	R
0xF627	SPDIF_RX_CS_RIGHT_7	S/PDIF receiver channel status bits (right)	0x0000	R
0xF628	SPDIF_RX_CS_RIGHT_8	S/PDIF receiver channel status bits (right)	0x0000	R
0xF629	SPDIF_RX_CS_RIGHT_9	S/PDIF receiver channel status bits (right)	0x0000	R
0xF62A	SPDIF_RX_CS_RIGHT_10	S/PDIF receiver channel status bits (right)	0x0000	R
0xF62B	SPDIF_RX_CS_RIGHT_11	S/PDIF receiver channel status bits (right)	0x0000	R

Address	Register Name	Description	Reset	RW
0xF630	SPDIF_RX_UD_LEFT_0	S/PDIF receiver user data bits (left)	0x0000	R
0xF631	SPDIF_RX_UD_LEFT_1	S/PDIF receiver user data bits (left)	0x0000	R
0xF632	SPDIF_RX_UD_LEFT_2	S/PDIF receiver user data bits (left)	0x0000	R
0xF633	SPDIF_RX_UD_LEFT_3	S/PDIF receiver user data bits (left)	0x0000	R
0xF634	SPDIF_RX_UD_LEFT_4	S/PDIF receiver user data bits (left)	0x0000	R
0xF635	SPDIF_RX_UD_LEFT_5	S/PDIF receiver user data bits (left)	0x0000	R
0xF636	SPDIF_RX_UD_LEFT_6	S/PDIF receiver user data bits (left)	0x0000	R
0xF637	SPDIF_RX_UD_LEFT_7	S/PDIF receiver user data bits (left)	0x0000	R
0xF638	SPDIF_RX_UD_LEFT_8	S/PDIF receiver user data bits (left)	0x0000	R
0xF639	SPDIF_RX_UD_LEFT_9	S/PDIF receiver user data bits (left)	0x0000	R
0xF63A	SPDIF_RX_UD_LEFT_10	S/PDIF receiver user data bits (left)	0x0000	R
0xF63B	SPDIF_RX_UD_LEFT_11	S/PDIF receiver user data bits (left)	0x0000	R
0xF640	SPDIF_RX_UD_RIGHT_0	S/PDIF receiver user data bits (right)	0x0000	R
0xF641	SPDIF_RX_UD_RIGHT_1	S/PDIF receiver user data bits (right)	0x0000	R
0xF642	SPDIF_RX_UD_RIGHT_2	S/PDIF receiver user data bits (right)	0x0000	R
0xF643	SPDIF_RX_UD_RIGHT_3	S/PDIF receiver user data bits (right)	0x0000	R
0xF644	SPDIF_RX_UD_RIGHT_4	S/PDIF receiver user data bits (right)	0x0000	R
0xF645	SPDIF_RX_UD_RIGHT_5	S/PDIF receiver user data bits (right)	0x0000	R
0xF646	SPDIF_RX_UD_RIGHT_6	S/PDIF receiver user data bits (right)	0x0000	R
0xF647	SPDIF_RX_UD_RIGHT_7	S/PDIF receiver user data bits (right)	0x0000	R
0xF648	SPDIF_RX_UD_RIGHT_8	S/PDIF receiver user data bits (right)	0x0000	R
0xF649	SPDIF_RX_UD_RIGHT_9	S/PDIF receiver user data bits (right)	0x0000	R
0xF64A	SPDIF_RX_UD_RIGHT_10	S/PDIF receiver user data bits (right)	0x0000	R
0xF64B	SPDIF_RX_UD_RIGHT_11	S/PDIF receiver user data bits (right)	0x0000	R
0xF650	SPDIF_RX_VB_LEFT_0	S/PDIF receiver validity bits (left)	0x0000	R
0xF651	SPDIF_RX_VB_LEFT_1	S/PDIF receiver validity bits (left)	0x0000	R
0xF652	SPDIF_RX_VB_LEFT_2	S/PDIF receiver validity bits (left)	0x0000	R
0xF653	SPDIF_RX_VB_LEFT_3	S/PDIF receiver validity bits (left)	0x0000	R
0xF654	SPDIF_RX_VB_LEFT_4	S/PDIF receiver validity bits (left)	0x0000	R
0xF655	SPDIF_RX_VB_LEFT_5	S/PDIF receiver validity bits (left)	0x0000	R
0xF656	SPDIF_RX_VB_LEFT_6	S/PDIF receiver validity bits (left)	0x0000	R
0xF657	SPDIF_RX_VB_LEFT_7	S/PDIF receiver validity bits (left)	0x0000	R
0xF658	SPDIF_RX_VB_LEFT_8	S/PDIF receiver validity bits (left)	0x0000	R
0xF659	SPDIF_RX_VB_LEFT_9	S/PDIF receiver validity bits (left)	0x0000	R
0xF65A	SPDIF_RX_VB_LEFT_10	S/PDIF receiver validity bits (left)	0x0000	R
0xF65B	SPDIF_RX_VB_LEFT_11	S/PDIF receiver validity bits (left)	0x0000	R
0xF660	SPDIF_RX_VB_RIGHT_0	S/PDIF receiver validity bits (right)	0x0000	R
0xF661	SPDIF_RX_VB_RIGHT_1	S/PDIF receiver validity bits (right)	0x0000	R
0xF662	SPDIF_RX_VB_RIGHT_2	S/PDIF receiver validity bits (right)	0x0000	R
0xF663	SPDIF_RX_VB_RIGHT_3	S/PDIF receiver validity bits (right)	0x0000	R
0xF664	SPDIF_RX_VB_RIGHT_4	S/PDIF receiver validity bits (right)	0x0000	R
0xF665	SPDIF_RX_VB_RIGHT_5	S/PDIF receiver validity bits (right)	0x0000	R
0xF666	SPDIF_RX_VB_RIGHT_6	S/PDIF receiver validity bits (right)	0x0000	R
0xF667	SPDIF_RX_VB_RIGHT_7	S/PDIF receiver validity bits (right)	0x0000	R
0xF668	SPDIF_RX_VB_RIGHT_8	S/PDIF receiver validity bits (right)	0x0000	R
0xF669	SPDIF_RX_VB_RIGHT_9	S/PDIF receiver validity bits (right)	0x0000	R
0xF66A	SPDIF_RX_VB_RIGHT_10	S/PDIF receiver validity bits (right)	0x0000	R
0xF66B	SPDIF_RX_VB_RIGHT_11	S/PDIF receiver validity bits (right)	0x0000	R
0xF670	SPDIF_RX_PB_LEFT_0	S/PDIF receiver parity bits (left)	0x0000	R
0xF671	SPDIF_RX_PB_LEFT_1	S/PDIF receiver parity bits (left)	0x0000	R
0xF672	SPDIF_RX_PB_LEFT_2	S/PDIF receiver parity bits (left)	0x0000	R
0xF673	SPDIF_RX_PB_LEFT_3	S/PDIF receiver parity bits (left)	0x0000	R
0xF674	SPDIF_RX_PB_LEFT_4	S/PDIF receiver parity bits (left)	0x0000	R
0xF675	SPDIF_RX_PB_LEFT_5	S/PDIF receiver parity bits (left)	0x0000	R

Address	Register Name	Description	Reset	RW
0xF676	SPDIF_RX_PB_LEFT_6	S/PDIF receiver parity bits (left)	0x0000	R
0xF677	SPDIF_RX_PB_LEFT_7	S/PDIF receiver parity bits (left)	0x0000	R
0xF678	SPDIF_RX_PB_LEFT_8	S/PDIF receiver parity bits (left)	0x0000	R
0xF679	SPDIF_RX_PB_LEFT_9	S/PDIF receiver parity bits (left)	0x0000	R
0xF67A	SPDIF_RX_PB_LEFT_10	S/PDIF receiver parity bits (left)	0x0000	R
0xF67B	SPDIF_RX_PB_LEFT_11	S/PDIF receiver parity bits (left)	0x0000	R
0xF680	SPDIF_RX_PB_RIGHT_0	S/PDIF receiver parity bits (right)	0x0000	R
0xF681	SPDIF_RX_PB_RIGHT_1	S/PDIF receiver parity bits (right)	0x0000	R
0xF682	SPDIF_RX_PB_RIGHT_2	S/PDIF receiver parity bits (right)	0x0000	R
0xF683	SPDIF_RX_PB_RIGHT_3	S/PDIF receiver parity bits (right)	0x0000	R
0xF684	SPDIF_RX_PB_RIGHT_4	S/PDIF receiver parity bits (right)	0x0000	R
0xF685	SPDIF_RX_PB_RIGHT_5	S/PDIF receiver parity bits (right)	0x0000	R
0xF686	SPDIF_RX_PB_RIGHT_6	S/PDIF receiver parity bits (right)	0x0000	R
0xF687	SPDIF_RX_PB_RIGHT_7	S/PDIF receiver parity bits (right)	0x0000	R
0xF688	SPDIF_RX_PB_RIGHT_8	S/PDIF receiver parity bits (right)	0x0000	R
0xF689	SPDIF_RX_PB_RIGHT_9	S/PDIF receiver parity bits (right)	0x0000	R
0xF68A	SPDIF_RX_PB_RIGHT_10	S/PDIF receiver parity bits (right)	0x0000	R
0xF68B	SPDIF_RX_PB_RIGHT_11	S/PDIF receiver parity bits (right)	0x0000	R
0xF690	SPDIF_TX_EN	S/PDIF transmitter enable	0x0000	RW
0xF691	SPDIF_TX_CTRL	S/PDIF transmitter control	0x0000	RW
0xF69F	SPDIF_TX_AUXBIT_SOURCE	S/PDIF transmitter auxiliary bits source select	0x0000	RW
0xF6A0	SPDIF_TX_CS_LEFT_0	S/PDIF transmitter channel status bits (left)	0x0000	RW
0xF6A1	SPDIF_TX_CS_LEFT_1	S/PDIF transmitter channel status bits (left)	0x0000	RW
0xF6A2	SPDIF_TX_CS_LEFT_2	S/PDIF transmitter channel status bits (left)	0x0000	RW
0xF6A3	SPDIF_TX_CS_LEFT_3	S/PDIF transmitter channel status bits (left)	0x0000	RW
0xF6A4	SPDIF_TX_CS_LEFT_4	S/PDIF transmitter channel status bits (left)	0x0000	RW
0xF6A5	SPDIF_TX_CS_LEFT_5	S/PDIF transmitter channel status bits (left)	0x0000	RW
0xF6A6	SPDIF_TX_CS_LEFT_6	S/PDIF transmitter channel status bits (left)	0x0000	RW
0xF6A7	SPDIF_TX_CS_LEFT_7	S/PDIF transmitter channel status bits (left)	0x0000	RW
0xF6A8	SPDIF_TX_CS_LEFT_8	S/PDIF transmitter channel status bits (left)	0x0000	RW
0xF6A9	SPDIF_TX_CS_LEFT_9	S/PDIF transmitter channel status bits (left)	0x0000	RW
0xF6AA	SPDIF_TX_CS_LEFT_10	S/PDIF transmitter channel status bits (left)	0x0000	RW
0xF6AB	SPDIF_TX_CS_LEFT_11	S/PDIF transmitter channel status bits (left)	0x0000	RW
0xF6B0	SPDIF_TX_CS_RIGHT_0	S/PDIF transmitter channel status bits (right)	0x0000	RW
0xF6B1	SPDIF_TX_CS_RIGHT_1	S/PDIF transmitter channel status bits (right)	0x0000	RW
0xF6B2	SPDIF_TX_CS_RIGHT_2	S/PDIF transmitter channel status bits (right)	0x0000	RW
0xF6B3	SPDIF_TX_CS_RIGHT_3	S/PDIF transmitter channel status bits (right)	0x0000	RW
0xF6B4	SPDIF_TX_CS_RIGHT_4	S/PDIF transmitter channel status bits (right)	0x0000	RW
0xF6B5	SPDIF_TX_CS_RIGHT_5	S/PDIF transmitter channel status bits (right)	0x0000	RW
0xF6B6	SPDIF_TX_CS_RIGHT_6	S/PDIF transmitter channel status bits (right)	0x0000	RW
0xF6B7	SPDIF_TX_CS_RIGHT_7	S/PDIF transmitter channel status bits (right)	0x0000	RW
0xF6B8	SPDIF_TX_CS_RIGHT_8	S/PDIF transmitter channel status bits (right)	0x0000	RW
0xF6B9	SPDIF_TX_CS_RIGHT_9	S/PDIF transmitter channel status bits (right)	0x0000	RW
0xF6BA	SPDIF_TX_CS_RIGHT_10	S/PDIF transmitter channel status bits (right)	0x0000	RW
0xF6BB	SPDIF_TX_CS_RIGHT_11	S/PDIF transmitter channel status bits (right)	0x0000	RW
0xF6C0	SPDIF_TX_UD_LEFT_0	S/PDIF transmitter user data bits (left)	0x0000	RW
0xF6C1	SPDIF_TX_UD_LEFT_1	S/PDIF transmitter user data bits (left)	0x0000	RW
0xF6C2	SPDIF_TX_UD_LEFT_2	S/PDIF transmitter user data bits (left)	0x0000	RW
0xF6C3	SPDIF_TX_UD_LEFT_3	S/PDIF transmitter user data bits (left)	0x0000	RW
0xF6C4	SPDIF_TX_UD_LEFT_4	S/PDIF transmitter user data bits (left)	0x0000	RW
0xF6C5	SPDIF_TX_UD_LEFT_5	S/PDIF transmitter user data bits (left)	0x0000	RW
0xF6C6	SPDIF_TX_UD_LEFT_6	S/PDIF transmitter user data bits (left)	0x0000	RW
0xF6C7	SPDIF_TX_UD_LEFT_7	S/PDIF transmitter user data bits (left)	0x0000	RW
0xF6C8	SPDIF_TX_UD_LEFT_8	S/PDIF transmitter user data bits (left)	0x0000	RW

Address	Register Name	Description	Reset	RW
0xF6C9	SPDIF_TX_UD_LEFT_9	S/PDIF transmitter user data bits (left)	0x0000	RW
0xF6CA	SPDIF_TX_UD_LEFT_10	S/PDIF transmitter user data bits (left)	0x0000	RW
0xF6CB	SPDIF_TX_UD_LEFT_11	S/PDIF transmitter user data bits (left)	0x0000	RW
0xF6D0	SPDIF_TX_UD_RIGHT_0	S/PDIF transmitter user data bits (right)	0x0000	RW
0xF6D1	SPDIF_TX_UD_RIGHT_1	S/PDIF transmitter user data bits (right)	0x0000	RW
0xF6D2	SPDIF_TX_UD_RIGHT_2	S/PDIF transmitter user data bits (right)	0x0000	RW
0xF6D3	SPDIF_TX_UD_RIGHT_3	S/PDIF transmitter user data bits (right)	0x0000	RW
0xF6D4	SPDIF_TX_UD_RIGHT_4	S/PDIF transmitter user data bits (right)	0x0000	RW
0xF6D5	SPDIF_TX_UD_RIGHT_5	S/PDIF transmitter user data bits (right)	0x0000	RW
0xF6D6	SPDIF_TX_UD_RIGHT_6	S/PDIF transmitter user data bits (right)	0x0000	RW
0xF6D7	SPDIF_TX_UD_RIGHT_7	S/PDIF transmitter user data bits (right)	0x0000	RW
0xF6D8	SPDIF_TX_UD_RIGHT_8	S/PDIF transmitter user data bits (right)	0x0000	RW
0xF6D9	SPDIF_TX_UD_RIGHT_9	S/PDIF transmitter user data bits (right)	0x0000	RW
0xF6DA	SPDIF_TX_UD_RIGHT_10	S/PDIF transmitter user data bits (right)	0x0000	RW
0xF6DB	SPDIF_TX_UD_RIGHT_11	S/PDIF transmitter user data bits (right)	0x0000	RW
0xF6E0	SPDIF_TX_VB_LEFT_0	S/PDIF transmitter validity bits (left)	0x0000	RW
0xF6E1	SPDIF_TX_VB_LEFT_1	S/PDIF transmitter validity bits (left)	0x0000	RW
0xF6E2	SPDIF_TX_VB_LEFT_2	S/PDIF transmitter validity bits (left)	0x0000	RW
0xF6E3	SPDIF_TX_VB_LEFT_3	S/PDIF transmitter validity bits (left)	0x0000	RW
0xF6E4	SPDIF_TX_VB_LEFT_4	S/PDIF transmitter validity bits (left)	0x0000	RW
0xF6E5	SPDIF_TX_VB_LEFT_5	S/PDIF transmitter validity bits (left)	0x0000	RW
0xF6E6	SPDIF_TX_VB_LEFT_6	S/PDIF transmitter validity bits (left)	0x0000	RW
0xF6E7	SPDIF_TX_VB_LEFT_7	S/PDIF transmitter validity bits (left)	0x0000	RW
0xF6E8	SPDIF_TX_VB_LEFT_8	S/PDIF transmitter validity bits (left)	0x0000	RW
0xF6E9	SPDIF_TX_VB_LEFT_9	S/PDIF transmitter validity bits (left)	0x0000	RW
0xF6EA	SPDIF_TX_VB_LEFT_10	S/PDIF transmitter validity bits (left)	0x0000	RW
0xF6EB	SPDIF_TX_VB_LEFT_11	S/PDIF transmitter validity bits (left)	0x0000	RW
0xF6F0	SPDIF_TX_VB_RIGHT_0	S/PDIF transmitter validity bits (right)	0x0000	RW
0xF6F1	SPDIF_TX_VB_RIGHT_1	S/PDIF transmitter validity bits (right)	0x0000	RW
0xF6F2	SPDIF_TX_VB_RIGHT_2	S/PDIF transmitter validity bits (right)	0x0000	RW
0xF6F3	SPDIF_TX_VB_RIGHT_3	S/PDIF transmitter validity bits (right)	0x0000	RW
0xF6F4	SPDIF_TX_VB_RIGHT_4	S/PDIF transmitter validity bits (right)	0x0000	RW
0xF6F5	SPDIF_TX_VB_RIGHT_5	S/PDIF transmitter validity bits (right)	0x0000	RW
0xF6F6	SPDIF_TX_VB_RIGHT_6	S/PDIF transmitter validity bits (right)	0x0000	RW
0xF6F7	SPDIF_TX_VB_RIGHT_7	S/PDIF transmitter validity bits (right)	0x0000	RW
0xF6F8	SPDIF_TX_VB_RIGHT_8	S/PDIF transmitter validity bits (right)	0x0000	RW
0xF6F9	SPDIF_TX_VB_RIGHT_9	S/PDIF transmitter validity bits (right)	0x0000	RW
0xF6FA	SPDIF_TX_VB_RIGHT_10	S/PDIF transmitter validity bits (right)	0x0000	RW
0xF6FB	SPDIF_TX_VB_RIGHT_11	S/PDIF transmitter validity bits (right)	0x0000	RW
0xF700	SPDIF_TX_PB_LEFT_0	S/PDIF transmitter parity bits (left)	0x0000	RW
0xF701	SPDIF_TX_PB_LEFT_1	S/PDIF transmitter parity bits (left)	0x0000	RW
0xF702	SPDIF_TX_PB_LEFT_2	S/PDIF transmitter parity bits (left)	0x0000	RW
0xF703	SPDIF_TX_PB_LEFT_3	S/PDIF transmitter parity bits (left)	0x0000	RW
0xF704	SPDIF_TX_PB_LEFT_4	S/PDIF transmitter parity bits (left)	0x0000	RW
0xF705	SPDIF_TX_PB_LEFT_5	S/PDIF transmitter parity bits (left)	0x0000	RW
0xF706	SPDIF_TX_PB_LEFT_6	S/PDIF transmitter parity bits (left)	0x0000	RW
0xF707	SPDIF_TX_PB_LEFT_7	S/PDIF transmitter parity bits (left)	0x0000	RW
0xF708	SPDIF_TX_PB_LEFT_8	S/PDIF transmitter parity bits (left)	0x0000	RW
0xF709	SPDIF_TX_PB_LEFT_9	S/PDIF transmitter parity bits (left)	0x0000	RW
0xF70A	SPDIF_TX_PB_LEFT_10	S/PDIF transmitter parity bits (left)	0x0000	RW
0xF70B	SPDIF_TX_PB_LEFT_11	S/PDIF transmitter parity bits (left)	0x0000	RW
0xF710	SPDIF_TX_PB_RIGHT_0	S/PDIF transmitter parity bits (right)	0x0000	RW
0xF711	SPDIF_TX_PB_RIGHT_1	S/PDIF transmitter parity bits (right)	0x0000	RW
0xF712	SPDIF_TX_PB_RIGHT_2	S/PDIF transmitter parity bits (right)	0x0000	RW



Address	Register Name	Description	Reset	RW
0xF713	SPDIF_TX_PB_RIGHT_3	S/PDIF transmitter parity bits (right)	0x0000	RW
0xF714	SPDIF_TX_PB_RIGHT_4	S/PDIF transmitter parity bits (right)	0x0000	RW
0xF715	SPDIF_TX_PB_RIGHT_5	S/PDIF transmitter parity bits (right)	0x0000	RW
0xF716	SPDIF_TX_PB_RIGHT_6	S/PDIF transmitter parity bits (right)	0x0000	RW
0xF717	SPDIF_TX_PB_RIGHT_7	S/PDIF transmitter parity bits (right)	0x0000	RW
0xF718	SPDIF_TX_PB_RIGHT_8	S/PDIF transmitter parity bits (right)	0x0000	RW
0xF719	SPDIF_TX_PB_RIGHT_9	S/PDIF transmitter parity bits (right)	0x0000	RW
0xF71A	SPDIF_TX_PB_RIGHT_10	S/PDIF transmitter parity bits (right)	0x0000	RW
0xF71B	SPDIF_TX_PB_RIGHT_11	S/PDIF transmitter parity bits (right)	0x0000	RW
0xF780	BCLK_IN0_PIN	BCLK input pins drive strength and slew rate (BCLK_IN0)	0x0018	RW
0xF781	BCLK_IN1_PIN	BCLK input pins drive strength and slew rate (BCLK_IN1)	0x0018	RW
0xF782	BCLK_IN2_PIN	BCLK input pins drive strength and slew rate (BCLK_IN2)	0x0018	RW
0xF783	BCLK_IN3_PIN	BCLK input pins drive strength and slew rate (BCLK_IN3)	0x0018	RW
0xF784	BCLK_OUT0_PIN	BCLK output pins drive strength and slew rate (BCLK_OUT0)	0x0018	RW
0xF785	BCLK_OUT1_PIN	BCLK output pins drive strength and slew rate (BCLK_OUT1)	0x0018	RW
0xF786	BCLK_OUT2_PIN	BCLK output pins drive strength and slew rate (BCLK_OUT2)	0x0018	RW
0xF787	BCLK_OUT3_PIN	BCLK output pins drive strength and slew rate (BCLK_OUT3)	0x0018	RW
0xF788	LRCLK_IN0_PIN	LRCLK input pins drive strength and slew rate (LRCLK_IN0)	0x0018	RW
0xF789	LRCLK_IN1_PIN	LRCLK input pins drive strength and slew rate (LRCLK_IN1)	0x0018	RW
0xF78A	LRCLK_IN2_PIN	LRCLK input pins drive strength and slew rate (LRCLK_IN2)	0x0018	RW
0xF78B	LRCLK_IN3_PIN	LRCLK input pins drive strength and slew rate (LRCLK_IN3)	0x0018	RW
0xF78C	LRCLK_OUT0_PIN	LRCLK output pins drive strength and slew rate (LRCLK_OUT0)	0x0018	RW
0xF78D	LRCLK_OUT1_PIN	LRCLK output pins drive strength and slew rate (LRCLK_OUT1)	0x0018	RW
0xF78E	LRCLK_OUT2_PIN	LRCLK output pins drive strength and slew rate (LRCLK_OUT2)	0x0018	RW
0xF78F	LRCLK_OUT3_PIN	LRCLK output pins drive strength and slew rate (LRCLK_OUT3)	0x0018	RW
0xF790	SDATA_IN0_PIN	SDATA input pins drive strength and slew rate (SDATA_IN0)	0x0018	RW
0xF791	SDATA_IN1_PIN	SDATA input pins drive strength and slew rate (SDATA_IN1)	0x0018	RW
0xF792	SDATA_IN2_PIN	SDATA input pins drive strength and slew rate (SDATA_IN2)	0x0018	RW
0xF793	SDATA_IN3_PIN	SDATA input pins drive strength and slew rate (SDATA_IN3)	0x0018	RW
0xF794	SDATA_OUT0_PIN	SDATA output pins drive strength and slew rate (SDATA_OUT0)	0x0008	RW
0xF795	SDATA_OUT1_PIN	SDATA output pins drive strength and slew rate (SDATA_OUT1)	0x0008	RW
0xF796	SDATA_OUT2_PIN	SDATA output pins drive strength and slew rate (SDATA_OUT2)	0x0008	RW
0xF797	SDATA_OUT3_PIN	SDATA output pins drive strength and slew rate (SDATA_OUT3)	0x0008	RW
0xF798	SPDIF_TX_PIN	S/PDIF transmitter pin drive strength and slew rate	0x0008	RW
0xF799	SCLK_SCL_PIN	SCLK/SCL pin drive strength and slew rate	0x0008	RW
0xF79A	MISO_SDA_PIN	MISO/SDA pin drive strength and slew rate	0x0008	RW
0xF79B	SS_PIN	SS/ADDR0 pin drive strength and slew rate	0x0018	RW
0xF79C	MOSI_ADDR1_PIN	MOSI/ADDR1 pin drive strength and slew rate	0x0018	RW
0xF79D	SCLK_SCL_M_PIN	SCL_M/SCLK_M/MP2 pin drive strength and slew rate	0x0008	RW
0xF79E	MISO_SDA_M_PIN	SDA_M/MISO_M/MP3 pin drive strength and slew rate	0x0008	RW
0xF79F	SS_M_PIN	SS_M/MP0 pin drive strength and slew rate	0x0018	RW
0xF7A0	MOSI_M_PIN	MOSI_M/MP1 pin drive strength and slew rate	0x0018	RW
0xF7A1	MP6_PIN	MP6 pin drive strength and slew rate	0x0018	RW
0xF7A2	MP7_PIN	MP7 pin drive strength and slew rate	0x0018	RW
0xF7A3	CLKOUT_PIN	CLKOUT pin drive strength and slew rate	0x0008	RW
0xF890	SOFT_RESET	Soft reset	0x0001	RW

## CONTROL REGISTER DETAILS

### PLL CONFIGURATION REGISTERS

#### PLL Feedback Divider Register

Address: 0xF000, Reset: 0x0060, Name: PLL\_CTRL0

This register is the value of the feedback divider in the PLL. This value effectively multiplies the frequency of the input clock to the PLL, creating the output system clock, which clocks the DSP core and other digital circuit blocks. The format of the value stored in this register is binary integer in 7.0 format. For example, the default feedback divider value of 96 is stored as 0x60. The value written to this register does not take effect until Register 0xF003 (PLL\_ENABLE), Bit 0 (PLL\_ENABLE) changes state from 0b0 to 0b1.

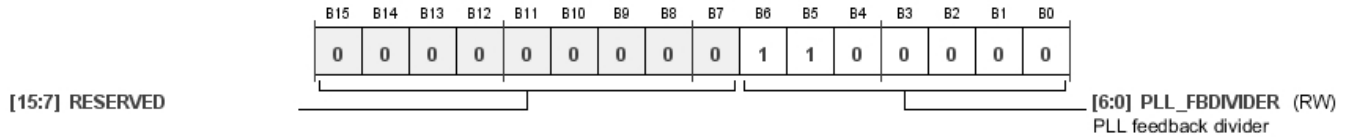

Table 65. Bit Descriptions for PLL\_CTRL0

Bits	Bit Name	Settings	Description	Reset	Access
[15:7]	RESERVED			0x0	RW
[6:0]	PLL_FBDIVIDER		PLL feedback divider. This is the value of the feedback divider in the PLL, which effectively multiplies the frequency of the input clock to the PLL, creating the output system clock, which clocks the DSP core and other digital circuit blocks. The format of the value stored in this register is binary integer in 7.0 format. For example, the default feedback divider value of 96 is stored as 0x60.	0x60	RW

#### PLL Prescale Divider Register

Address: 0xF001, Reset: 0x0000, Name: PLL\_CTRL1

This register sets the input prescale divider for the PLL. The value written to this register does not take effect until Register 0xF003 (PLL\_ENABLE), Bit 0 (PLL\_ENABLE) changes state from 0b0 to 0b1.

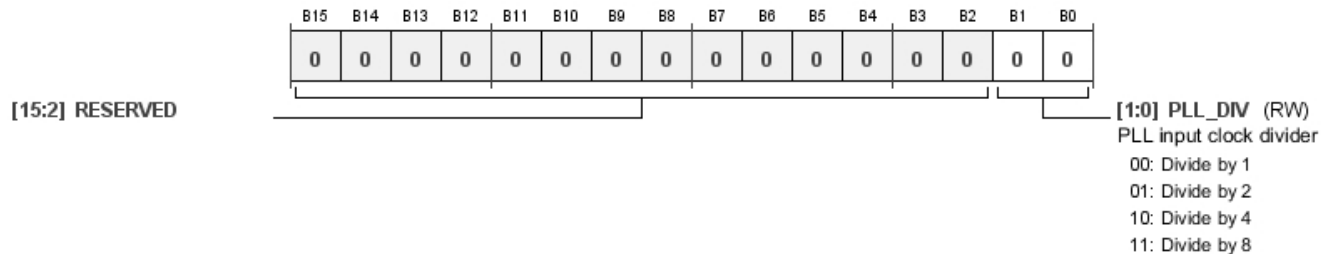

Table 66. Bit Descriptions for PLL\_CTRL1

Bits	Bit Name	Settings	Description	Reset	Access
[15:2]	RESERVED			0x0	RW
[1:0]	PLL_DIV		PLL input clock divider. This prescale clock divider creates the PLL input clock from the externally input master clock. The nominal frequency of the PLL input is 3.072 MHz. Therefore, if the input master clock frequency is 3.072 MHz, set the prescale clock divider to divide by 1. If the input clock is 12.288 MHz, set the prescale clock divider to divide by 4. The goal is to make the input to the PLL as close to 3.072 MHz as possible.	0x0	RW
		00	Divide by 1		
		01	Divide by 2		
		10	Divide by 4		
		11	Divide by 8		

**PLL Clock Source Register**

Address: 0xF002, Reset: 0x0000, Name: PLL\_CLK\_SRC

This register selects the source of the clock used for input to the core and the clock generators. The clock can either be taken directly from the signal on the XTALIN/MCLK pin or from the output of the PLL. In almost every case, the PLL clock should be used. The value written to this register does not take effect until Register 0xF003 (PLL\_ENABLE), Bit 0 (PLL\_ENABLE) changes state from 0b0 to 0b1.

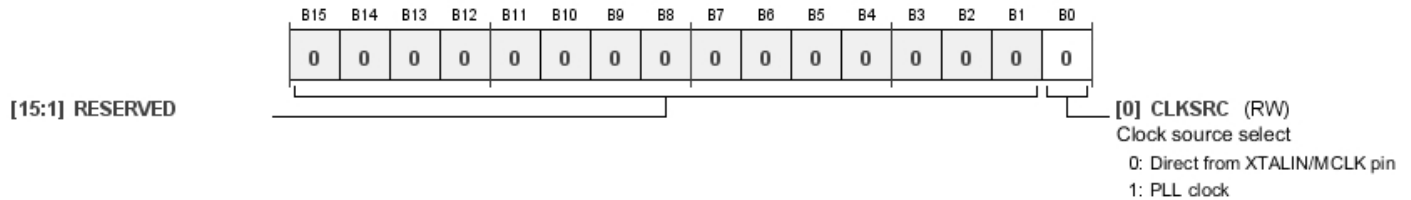

Table 67. Bit Descriptions for PLL\_CLK\_SRC

Bits	Bit Name	Settings	Description	Reset	Access
[15:1]	RESERVED			0x0	RW
0	CLKSRC	0 1	Clock source select. The PLL output is nominally 294.912 MHz, which is the nominal operating frequency of the core and the clock generator inputs. In most use cases, do not use the direct XTALIN/MCLK input option because the range of allowable frequencies on the XTALIN/MCLK pin is has an upper limit that is significantly lower in frequency than the nominal system clock frequency. 0 Direct from XTALIN/MCLK pin 1 PLL clock	0x0	RW

**PLL Enable Register**

Address: 0xF003, Reset: 0x0000, Name: PLL\_ENABLE

This register enables or disables the PLL. The PLL does not attempt to lock to an incoming clock until Bit 0 (PLL\_ENABLE) is enabled. When Bit 0 (PLL\_ENABLE) is set to 0b0, the PLL does not output a clock signal, causing all other clock circuits in the device that rely on the PLL to become idle. When Bit 0 (PLL\_ENABLE) transitions from 0b0 to 0b1, the settings in Register 0xF000 (PLL\_CTRL0), Register 0xF001 (PLL\_CTRL1), Register 0xF002 (PLL\_CLK\_SRC), and Register 0xF005 (MCLK\_OUT) are activated.

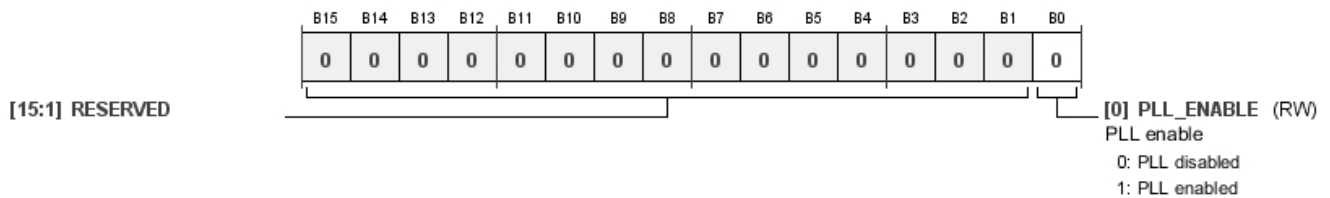

Table 68. Bit Descriptions for PLL\_ENABLE

Bits	Bit Name	Settings	Description	Reset	Access
[15:1]	RESERVED			0x0	RW
0	PLL_ENABLE	0 1	PLL enable. Load the values of Register 0xF000, Register 0xF001, Register 0xF002, and Register 0xF005 when this bit transitions from 0b0 to 0b1. 0 PLL disabled 1 PLL enabled	0x0	RW

**PLL Lock Register**

Address: 0xF004, Reset: 0x0000, Name: PLL\_LOCK

This register contains a flag that represents the lock status of the PLL. Lock status has four prerequisites: a stable input clock is being routed to the PLL, the related PLL registers (Register 0xF000 (PLL\_CTRL0), Register 0xF001 (PLL\_CTRL1), and Register 0xF002 (PLL\_CLK\_SRC)) are set appropriately, the PLL is enabled (Register 0xF003 (PLL\_ENABLE), Bit 0 (PLL\_ENABLE) = 0b1), and the PLL has had adequate time to adjust its feedback path and provide a stable output clock to the rest of the device. The amount of time required to achieve lock to a new input clock signal varies based on system conditions, so Bit 0 (PLL\_LOCK) provides a clear indication of when lock has been achieved.

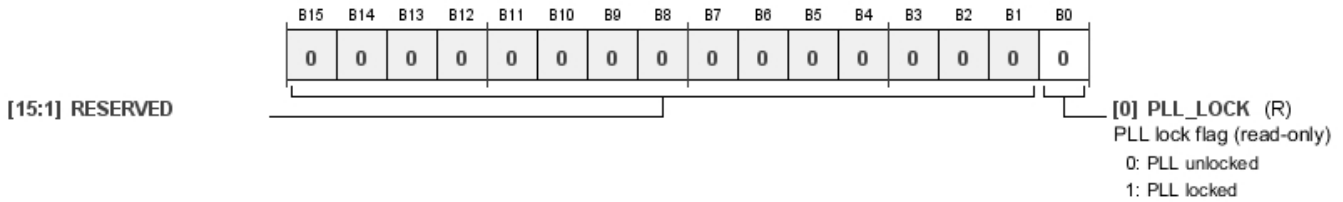

Table 69. Bit Descriptions for PLL\_LOCK

Bits	Bit Name	Settings	Description	Reset	Access
[15:1]	RESERVED			0x0	RW
0	PLL_LOCK	0 1	PLL lock flag (read only). PLL unlocked PLL locked	0x0	R

**CLKOUT Control Register**

Address: 0xF005, Reset: 0x0000, Name: MCLK\_OUT

This register enables and configures the signal output from the CLKOUT pin. The value written to this register does not take effect until Register 0xF003 (PLL\_ENABLE), Bit 0 (PLL\_ENABLE), changes state from 0b0 to 0b1.

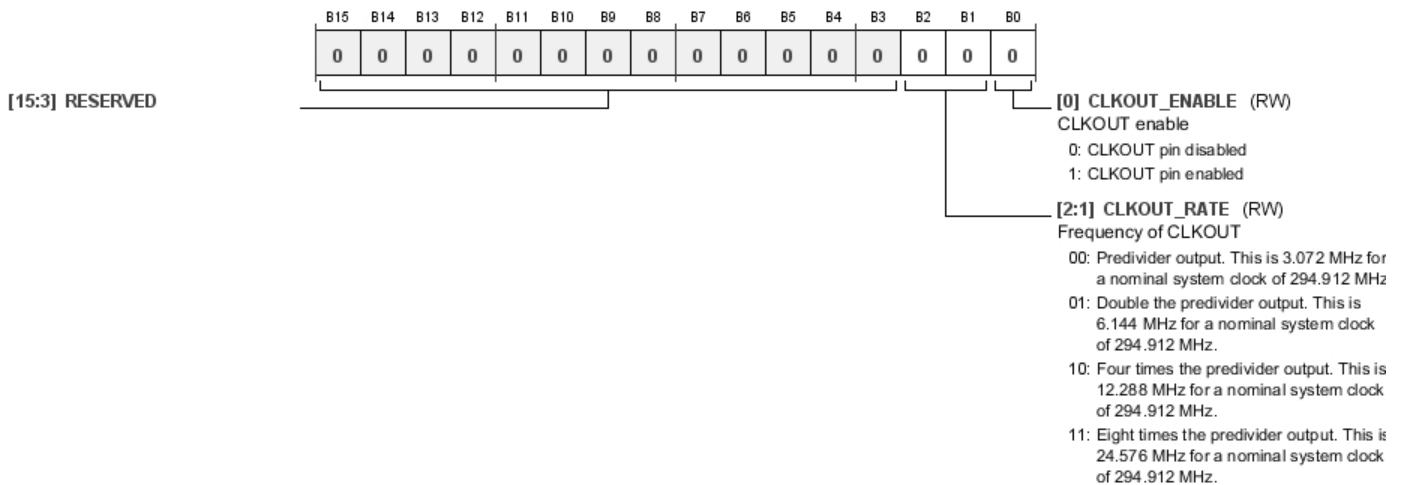

Table 70. Bit Descriptions for MCLK\_OUT

Bits	Bit Name	Settings	Description	Reset	Access
[15:3]	RESERVED			0x0	RW
[2:1]	CLKOUT_RATE	00 Predivider output. This is 3.072 MHz for a nominal system clock of 294.912 MHz. 01 Double the predivider output. This is 6.144 MHz for a nominal system clock of 294.912 MHz. 10 Four times the predivider output. This is 12.288 MHz for a nominal system clock of 294.912 MHz. 11 Eight times the predivider output. This is 24.576 MHz for a nominal system clock of 294.912 MHz.	Frequency of CLKOUT. Frequency of the signal output from the CLKOUT pin. These bits set the frequency of the signal on the CLKOUT pin. The frequencies documented in Table 70 are examples that are valid for a master clock input that is a binary multiple of 3.072 MHz. In this case, the options for output rates are 3.072 MHz, 6.144 MHz, 12.288 MHz, or 24.576 MHz. If the input master clock is scaled down (for example, to a binary multiple of 2.8224 MHz), the possible output rates are 2.8224 MHz, 5.6448 MHz, 11.2896 MHz, or 22.5792 MHz).	0x0	RW
0	CLKOUT_ENABLE	0 CLKOUT pin disabled 1 CLKOUT pin enabled	CLKOUT enable. When this bit is enabled, a clock signal is output from the CLKOUT pin of the device. When disabled, the CLKOUT pin is high impedance.	0x0	RW

**Analog PLL Watchdog Control Register**

Address: 0xF006, Reset: 0x0001, Name: PLL\_WATCHDOG

The PLL watchdog is a feature that monitors the PLL and automatically resets it in the event that it reaches an unstable condition. The PLL resets itself and automatically attempts to lock to the incoming clock signal again, with the same settings as before. This functionality requires no interaction on the part of the user. Ensure that the PLL watchdog is enabled at all times.

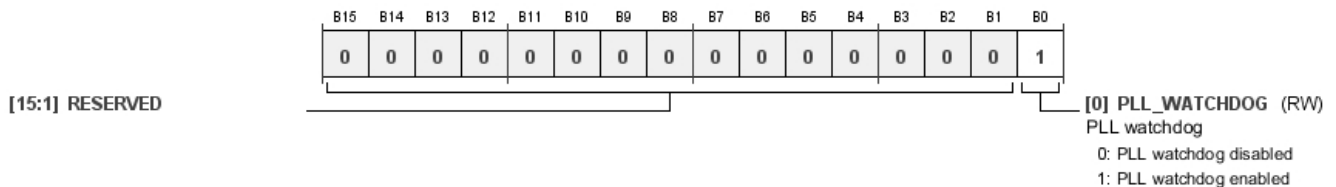

Table 71. Bit Descriptions for PLL\_WATCHDOG

Bits	Bit Name	Settings	Description	Reset	Access
[15:1]	RESERVED			0x0	RW
0	PLL_WATCHDOG	0 PLL watchdog disabled 1 PLL watchdog enabled	PLL watchdog.	0x1	RW

**CLOCK GENERATOR REGISTERS**

**Denominator (M) for Clock Generator 1 Register**

Address: 0xF020, Reset: 0x0006, Name: CLK\_GEN1\_M

The denominator (M) for Clock Generator 1.

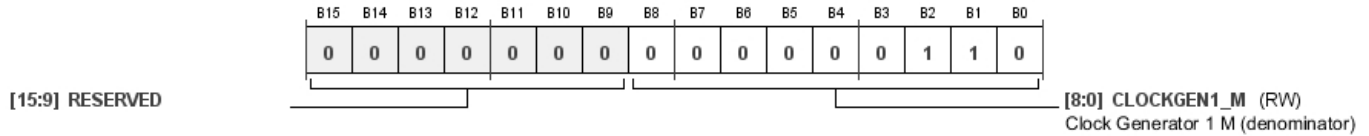

Table 72. Bit Descriptions for CLK\_GEN1\_M

Bits	Bit Name	Settings	Description	Reset	Access
[15:9]	RESERVED			0x0	RW
[8:0]	CLOCKGEN1_M		Clock Generator 1 M (denominator). Format is binary integer.	0x006	RW

**Numerator (N) for Clock Generator 1 Register**

Address: 0xF021, Reset: 0x0001, Name: CLK\_GEN1\_N

The numerator (N) for Clock Generator 1.

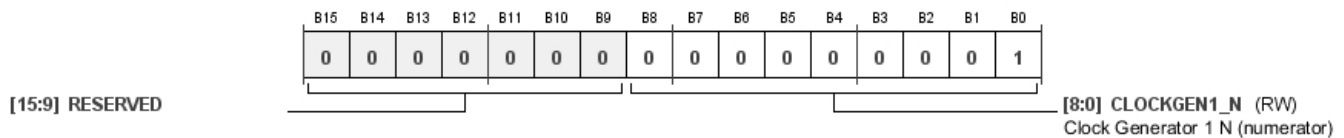

Table 73. Bit Descriptions for CLK\_GEN1\_N

Bits	Bit Name	Settings	Description	Reset	Access
[15:9]	RESERVED			0x0	RW
[8:0]	CLOCKGEN1_N		Clock Generator 1 N (numerator). Format is binary integer.	0x001	RW

**Denominator (M) for Clock Generator 2 Register**

Address: 0xF022, Reset: 0x0009, Name: CLK\_GEN2\_M

The denominator (M) for Clock Generator 2.

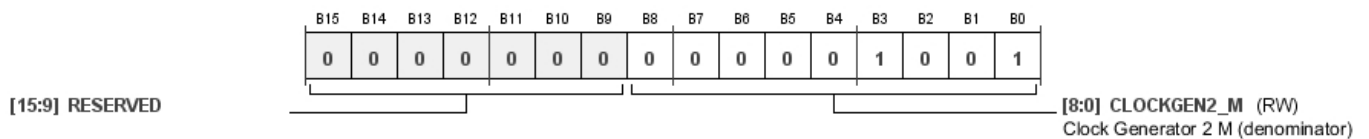

Table 74. Bit Descriptions for CLK\_GEN2\_M

Bits	Bit Name	Settings	Description	Reset	Access
[15:9]	RESERVED			0x0	RW
[8:0]	CLOCKGEN2_M		Clock Generator 2 M (denominator). Format is binary integer.	0x009	RW

**Numerator (N) for Clock Generator 2 Register**

Address: 0xF023, Reset: 0x0001, Name: CLK\_GEN2\_N

The numerator (N) for Clock Generator 2.

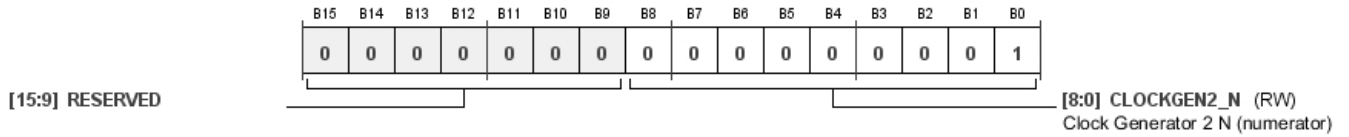

Table 75. Bit Descriptions for CLK\_GEN2\_N

Bits	Bit Name	Settings	Description	Reset	Access
[15:9]	RESERVED			0x0	RW
[8:0]	CLOCKGEN2_N		Clock Generator 2 N (numerator). Format is binary integer.	0x001	RW

**Denominator (M) for Clock Generator 3 Register**

Address: 0xF024, Reset: 0x0000, Name: CLK\_GEN3\_M

The denominator (M) for Clock Generator 3.

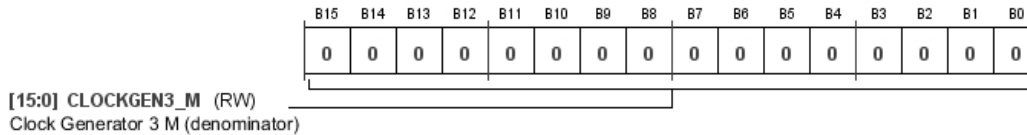

Table 76. Bit Descriptions for CLK\_GEN3\_M

Bits	Bit Name	Settings	Description	Reset	Access
[15:0]	CLOCKGEN3_M		Clock Generator 3 M (denominator). Format is binary integer.	0x0000	RW

**Numerator for (N) Clock Generator 3 Register**

Address: 0xF025, Reset: 0x0000, Name: CLK\_GEN3\_N

The numerator (N) for Clock Generator 3.

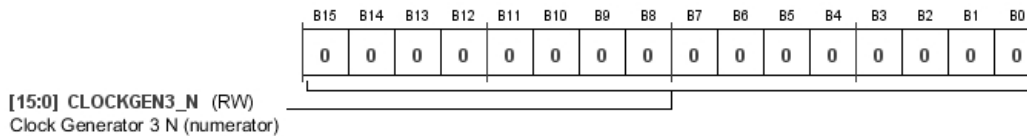

Table 77. Bit Descriptions for CLK\_GEN3\_N

Bits	Bit Name	Settings	Description	Reset	Access
[15:0]	CLOCKGEN3_N		Clock Generator 3 N (numerator). Format is binary integer.	0x0000	RW

**Input Reference for Clock Generator 3 Register**

Address: 0xF026, Reset: 0x000E, Name: CLK\_GEN3\_SRC

Clock Generator 3 can generate audio clocks using the PLL output (system clock) as a reference, or it can optionally use a reference clock entering the device from an external source either on a multipurpose pin (MPx) or the S/PDIF receiver. This register determines the source of the reference signal.

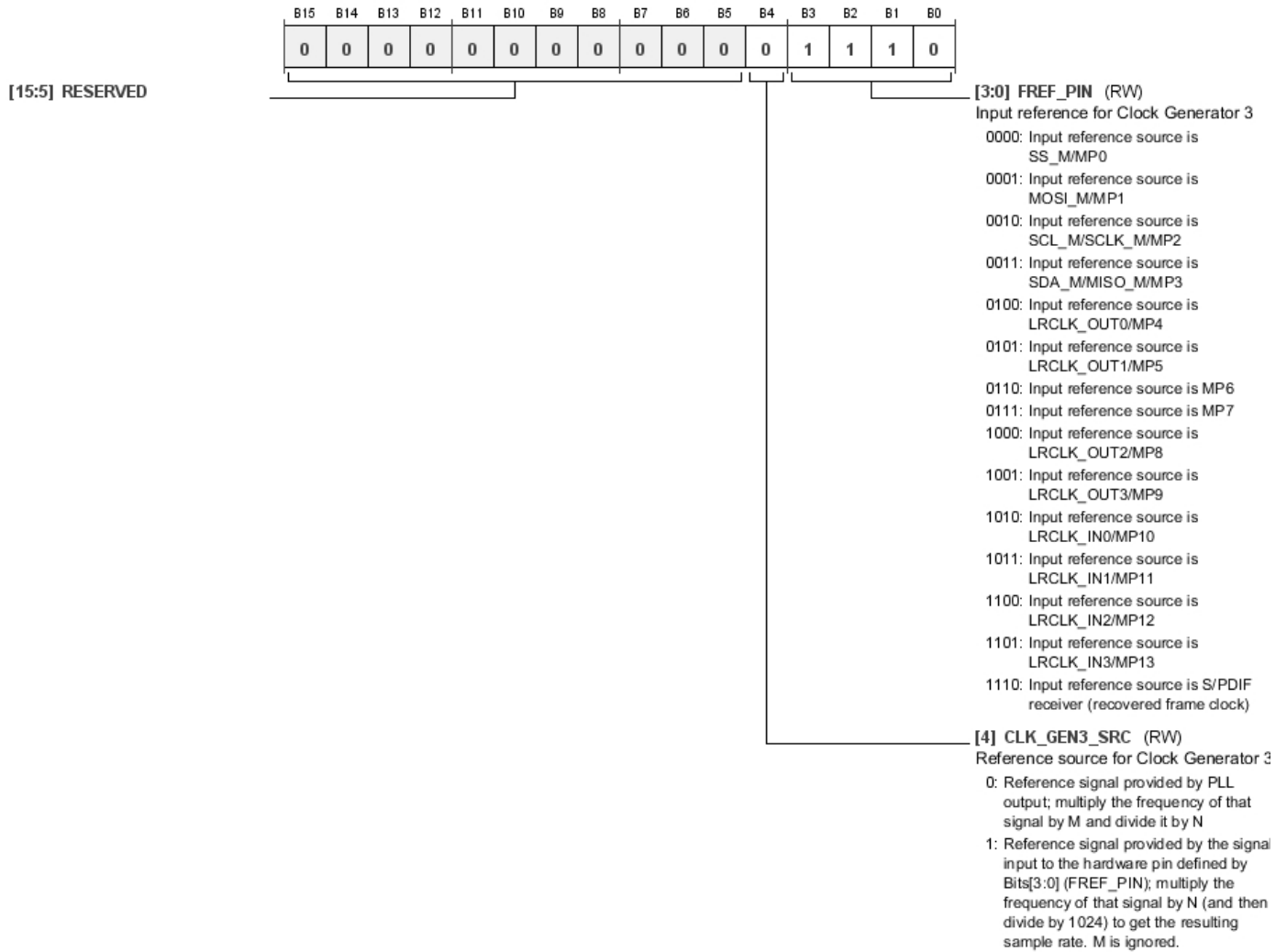

Table 78. Bit Descriptions for CLK\_GEN3\_SRC

Bits	Bit Name	Settings	Description	Reset	Access
[15:5]	RESERVED			0x0	RW



Bits	Bit Name	Settings	Description	Reset	Access
4	CLK_GEN3_SRC		Reference source for Clock Generator 3. This bit selects the reference of Clock Generator 3. If set to use an external reference clock, Bits[3:0] define the source pin. Otherwise, the PLL output is used as the reference clock. When an external reference clock is used for Clock Generator 3, the resulting base output frequency of Clock Generator 3 is the frequency of the input reference clock multiplied by the Clock Generator 3 numerator, divided by 1024. For example: if Bit 4 (CLK_GEN3_SRC) = 0b1 (an external reference clock is used); Bits[3:0] (FREF_PIN) = 0b1110 (the input signal of the S/PDIF receiver is used as the reference source); the sample rate of the S/PDIF input signal = 48 kHz; and the numerator of Clock Generator 3 = 2048; the resulting base output sample rate of Clock Generator 3 is 48 kHz × 2048/1024 = 96 kHz. 0 Reference signal provided by PLL output; multiply the frequency of that signal by M and divide it by N 1 Reference signal provided by the signal input to the hardware pin defined by Bits[3:0] (FREF_PIN); multiply the frequency of that signal by N (and then divide by 1024) to get the resulting sample rate; M is ignored	0x0	RW
[3:0]	FREF_PIN		Input reference for Clock Generator 3. If Clock Generator 3 is set up to lock to an external reference clock (Bit 4 (CLK_GEN3_SRC) = 0b1), these bits allow the user to specify which pin is receiving the reference clock. The signal input to the corresponding pin should be a 50% duty cycle square wave clock representing the reference sample rate. 0000 Input reference source is SS_M/MP0 0001 Input reference source is MOSI_M/MP1 0010 Input reference source is SCL_M/SCLK_M/MP2 0011 Input reference source is SDA_M/MISO_M/MP3 0100 Input reference source is LRCLK_OUT0/MP4 0101 Input reference source is LRCLK_OUT1/MP5 0110 Input reference source is MP6 0111 Input reference source is MP7 1000 Input reference source is LRCLK_OUT2/MP8 1001 Input reference source is LRCLK_OUT3/MP9 1010 Input reference source is LRCLK_IN0/MP10 1011 Input reference source is LRCLK_IN1/MP11 1100 Input reference source is LRCLK_IN2/MP12 1101 Input reference source is LRCLK_IN3/MP13 1110 Input reference source is S/PDIF receiver (recovered frame clock)	0xE	RW

### Lock Bit for Clock Generator 3 Input Reference Register

Address: 0xF027, Reset: 0x0000, Name: CLK\_GEN3\_LOCK

This register monitors whether or not Clock Generator 3 has locked to its reference clock source, regardless of whether it is coming from the PLL output or from an external reference signal, which is configured in Register 0xF026, Bit 4 (CLK\_GEN3\_SRC).

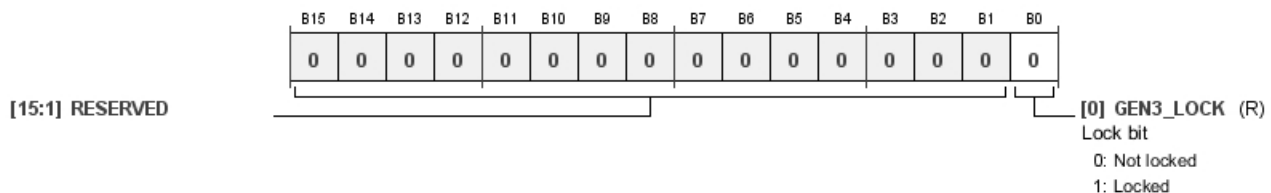

Table 79. Bit Descriptions for CLK\_GEN3\_LOCK

Bits	Bit Name	Settings	Description	Reset	Access
[15:1]	RESERVED			0x0	RW
0	GEN3_LOCK		Lock bit. 0 Not locked 1 Locked	0x0	R

**POWER REDUCTION REGISTERS**

**Power Enable 0 Register**

Address: 0xF050, Reset: 0x0000, Name: POWER\_ENABLE0

For the purpose of power savings, this register allows the clock generators, ASRCs, and serial ports to be disabled when not in use. When these functional blocks are disabled, the current draw on the corresponding supply pins decreases.

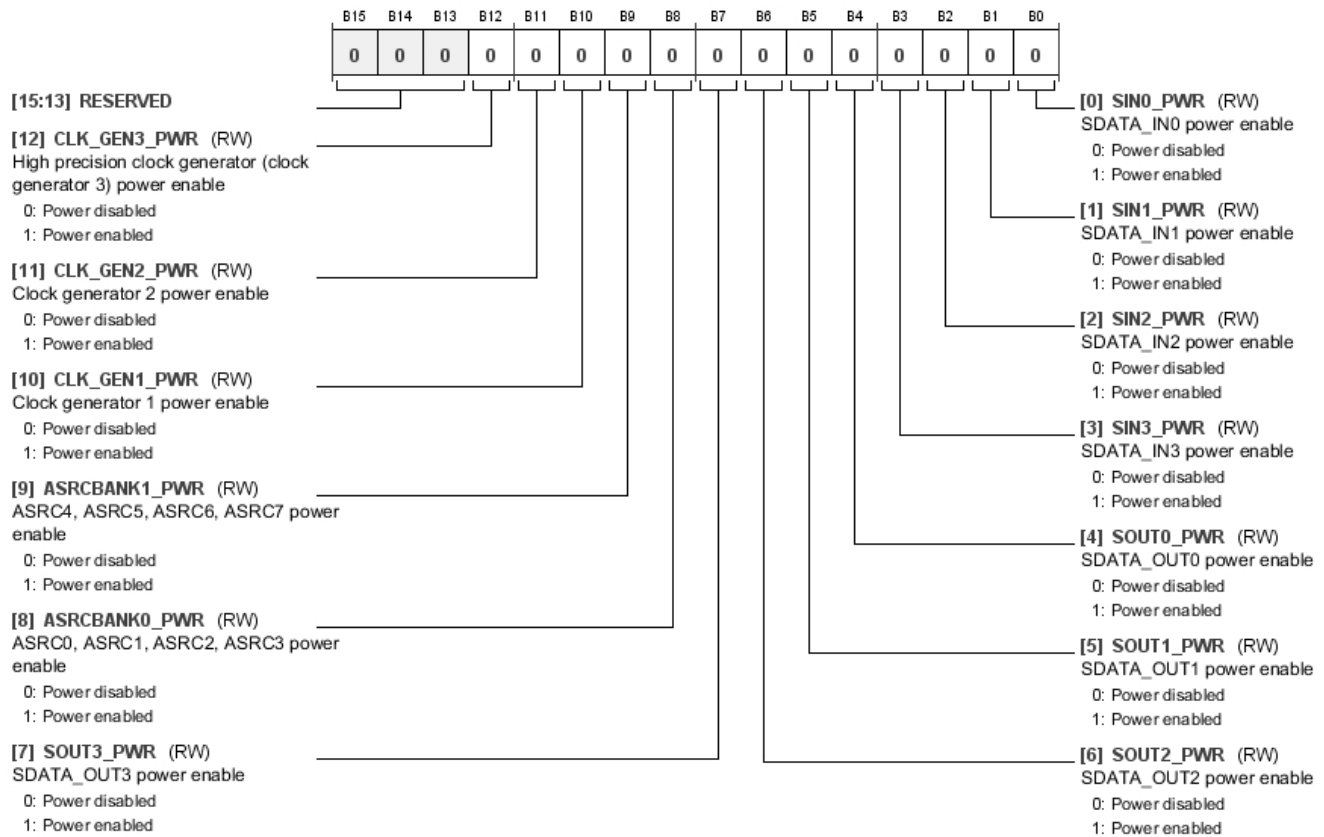

**Table 80. Bit Descriptions for POWER\_ENABLE0**

Bits	Bit Name	Settings	Description	Reset	Access
[15:13]	RESERVED			0x0	RW
12	CLK_GEN3_PWR	0 1	High precision clock generator (Clock Generator 3) power enable. When this bit is disabled, Clock Generator 3 is disabled and ceases to output audio clocks. Any functional block in hardware, including the DSP core, that has been configured to be clocked by Clock Generator 3 ceases to function while this bit is disabled. 0 Power disabled 1 Power enabled	0x0	RW
11	CLK_GEN2_PWR	0 1	Clock Generator 2 power enable. When this bit is disabled, Clock Generator 2 is disabled and ceases to output audio clocks. Any LRCLK_OUTx, LRCLK_INx or BCLK_OUTx, BCLK_INx pins that have been configured to output clocks generated by Clock Generator 2 output a logic low signal while Clock Generator 2 is disabled. Any functional block in hardware, including the DSP core, that has been configured to be clocked by Clock Generator 2 ceases to function while this bit is disabled. 0 Power disabled 1 Power enabled	0x0	RW

Bits	Bit Name	Settings	Description	Reset	Access
10	CLK_GEN1_PWR	0 1	Clock Generator 1 power enable. When this bit is disabled, Clock Generator 1 is disabled and ceases to output audio clocks. Any LRCLK_OUTx, LRCLK_INx or BCLK_OUTx, BCLK_INx pins that are configured to output clocks generated by Clock Generator 1 output a logic low signal while Clock Generator 1 is disabled. Any functional block in hardware, including the DSP core, that is configured to be clocked by Clock Generator 1 ceases to function when this bit is disabled. Power disabled Power enabled	0x0	RW
9	ASRCBANK1_PWR	0 1	ASRC 4, ASRC 5, ASRC 6, ASRC 7 power enable. When this bit is disabled, ASRC Channel 8 to Channel 15 are disabled, and their output data streams cease. Power disabled Power enabled	0x0	RW
8	ASRCBANK0_PWR	0 1	ASRC 0, ASRC 1, ASRC 2, ASRC 3 power enable. When this bit is disabled, ASRC Channel 0 to Channel 7 are disabled, and their output data streams cease. Power disabled Power enabled	0x0	RW
7	SOUT3_PWR	0 1	SDATA_OUT3 power enable. When this bit is disabled, the SDATA_OUT3 pin and associated serial port circuitry are also disabled. LRCLK_OUT3 and BCLK_OUT3 are not affected. Power disabled Power enabled	0x0	RW
6	SOUT2_PWR	0 1	SDATA_OUT2 power enable. When this bit is disabled, the SDATA_OUT2 pin and associated serial port circuitry is disabled. LRCLK_OUT2 and BCLK_OUT2 are not affected. Power disabled Power enabled	0x0	RW
5	SOUT1_PWR	0 1	SDATA_OUT1 power enable. When this bit is disabled, the SDATA_OUT1 pin and associated serial port circuitry are also disabled. LRCLK_OUT1 and BCLK_OUT1 are not affected. Power disabled Power enabled	0x0	RW
4	SOUT0_PWR	0 1	SDATA_OUT0 power enable. When this bit is disabled, the SDATA_OUT0 pin and associated serial port circuitry are disabled. LRCLK_OUT0 and BCLK_OUT0 are not affected. Power disabled Power enabled	0x0	RW
3	SIN3_PWR	0 1	SDATA_IN3 power enable. When this bit is disabled, the SDATA_IN3 pin and associated serial port circuitry are disabled. LRCLK_IN3 and BCLK_IN3 are not affected. Power disabled Power enabled	0x0	RW
2	SIN2_PWR	0 1	SDATA_IN2 power enable. When this bit is disabled, the SDATA_IN2 pin and associated serial port circuitry are disabled. LRCLK_IN2 and BCLK_IN2 are not affected. Power disabled Power enabled	0x0	RW
1	SIN1_PWR	0 1	SDATA_IN1 power enable. When this bit is disabled, the SDATA_IN1 pin and associated serial port circuitry are disabled. The LRCLK_IN1 and BCLK_IN1 pins are not affected. Power disabled Power enabled	0x0	RW
0	SIN0_PWR	0 1	SDATA_IN0 power enable. When this bit is disabled, the SDATA_IN0 pin and associated serial port circuitry are disabled. The LRCLK_IN0 and BCLK_IN0 pins are not affected. Power disabled Power enabled	0x0	RW

**Power Enable 1 Register**

Address: 0xF051, Reset: 0x0000, Name: POWER\_ENABLE1

For the purpose of power savings, this register allows the PDM microphone interfaces, S/PDIF interfaces, and auxiliary ADCs to be disabled when not in use. When these functional blocks are disabled, the current draw on the corresponding supply pins decreases.

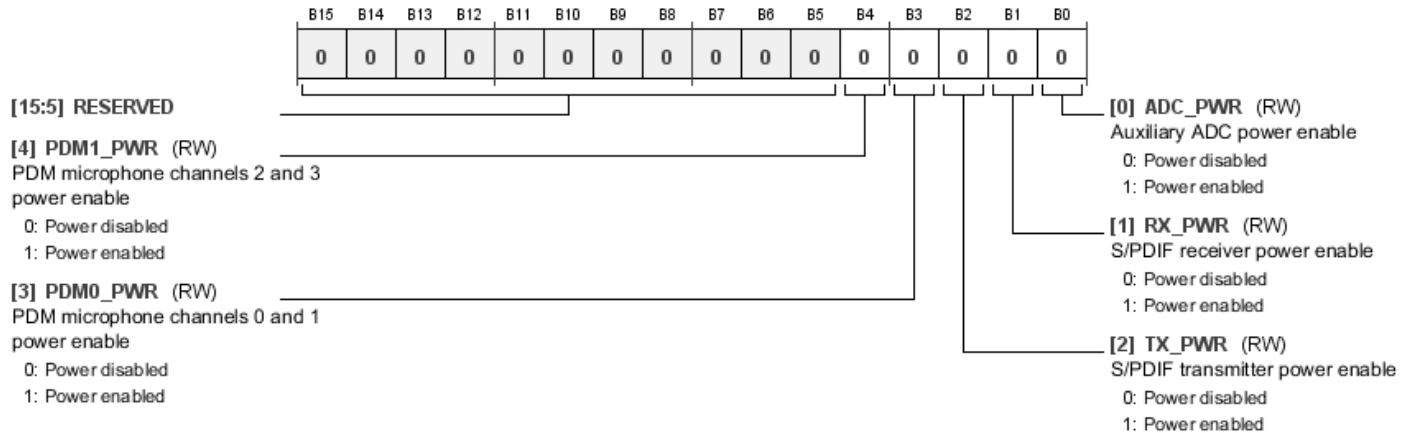

**Table 81. Bit Descriptions for POWER\_ENABLE1**

Bits	Bit Name	Settings	Description	Reset	Access
[15:5]	RESERVED			0x0	RW
4	PDM1_PWR	0 1	PDM Microphone Channel 2 and PDM Microphone Channel 3 power enable. When this bit is disabled, PDM Microphone Channel 2 and PDM Microphone Channel 3 and their associated circuitry are disabled, and their data values cease to update. 0 Power disabled 1 Power enabled	0x0	RW
3	PDM0_PWR	0 1	PDM Microphone Channel 0 and PDM Microphone Channel 1 power enable. When this bit is disabled, PDM Microphone Channel 0 and PDM Microphone Channel 1 and their associated circuitry are disabled, and their data values cease to update. 0 Power disabled 1 Power enabled	0x0	RW
2	TX_PWR	0 1	S/PDIF transmitter power enable. This bit disables the S/PDIF transmitter circuit. Clock and data ceases to output from the S/PDIF transmitter pin, and the output is held at logic low as long as this bit is disabled. 0 Power disabled 1 Power enabled	0x0	RW
1	RX_PWR	0 1	S/PDIF receiver power enable. This bit disables the S/PDIF receiver circuit. Clock and data recovery from the S/PDIF input stream ceases until this bit is reenabled. 0 Power disabled 1 Power enabled	0x0	RW
0	ADC_PWR	0 1	Auxiliary ADC power enable. When this bit is disabled, the auxiliary ADCs are powered down, their outputs cease to update, and they hold their last value. 0 Power disabled 1 Power enabled	0x0	RW

**AUDIO SIGNAL ROUTING REGISTERS**

**ASRC Input Selector Register**

Address: 0xF100 to Address 0xF107 (Increments of 0x1), Reset: 0x0000, Name: ASRC\_INPUTx

These eight registers configure the input signal to the corresponding eight stereo ASRCs on the ADAU1452 and ADAU1451. ASRC\_INPUT0 configures ASRC Channel 0 and ASRC Channel 1, ASRC\_INPUT1 configures ASRC Channel 2 and ASRC Channel 3, and so on. Valid input signals to the ASRCs include Serial Input Channel 0 to Serial Input Channel 47, the PDM Microphone Input Channel 0 to PDM Microphone Input Channel 3, and the S/PDIF Receiver Channel 0 to S/PDIF Receiver Channel 1.

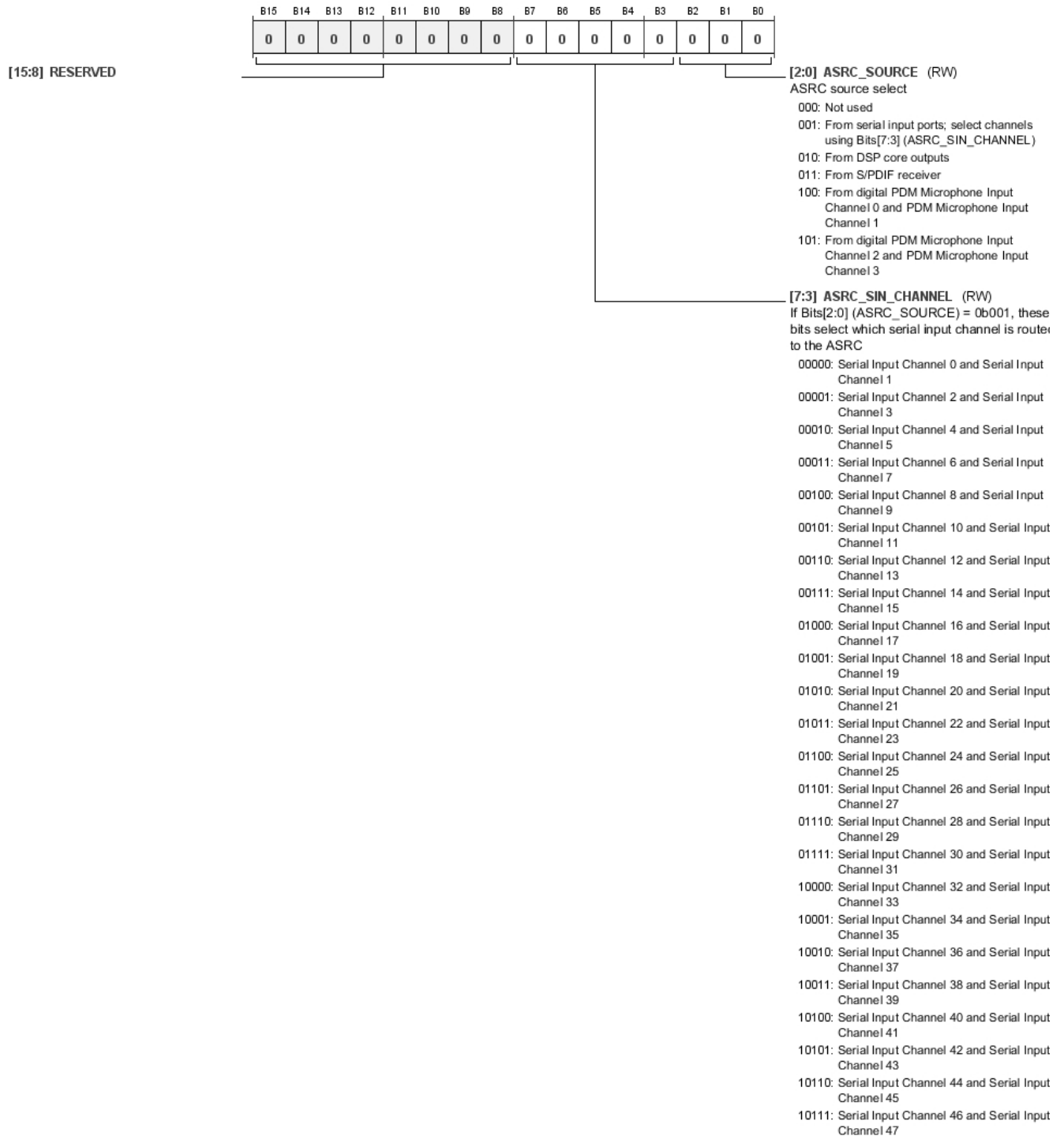

Table 82. Bit Descriptions for ASRC\_INPUTx

Bits	Bit Name	Settings	Description	Reset	Access
[15:8]	RESERVED			0x0	RW
[7:3]	ASRC_SIN_CHANNEL	00000 Serial Input Channel 0 and Serial Input Channel 1 00001 Serial Input Channel 2 and Serial Input Channel 3 00010 Serial Input Channel 4 and Serial Input Channel 5 00011 Serial Input Channel 6 and Serial Input Channel 7 00100 Serial Input Channel 8 and Serial Input Channel 9 00101 Serial Input Channel 10 and Serial Input Channel 11 00110 Serial Input Channel 12 and Serial Input Channel 13 00111 Serial Input Channel 14 and Serial Input Channel 15 01000 Serial Input Channel 16 and Serial Input Channel 17 01001 Serial Input Channel 18 and Serial Input Channel 19 01010 Serial Input Channel 20 and Serial Input Channel 21 01011 Serial Input Channel 22 and Serial Input Channel 23 01100 Serial Input Channel 24 and Serial Input Channel 25 01101 Serial Input Channel 26 and Serial Input Channel 27 01110 Serial Input Channel 28 and Serial Input Channel 29 01111 Serial Input Channel 30 and Serial Input Channel 31 10000 Serial Input Channel 32 and Serial Input Channel 33 10001 Serial Input Channel 34 and Serial Input Channel 35 10010 Serial Input Channel 36 and Serial Input Channel 37 10011 Serial Input Channel 38 and Serial Input Channel 39 10100 Serial Input Channel 40 and Serial Input Channel 41 10101 Serial Input Channel 42 and Serial Input Channel 43 10110 Serial Input Channel 44 and Serial Input Channel 45 10111 Serial Input Channel 46 and Serial Input Channel 47	If Bits[2:0] (ASRC_SOURCE) = 0b001, these bits select which serial input channel is routed to the ASRC.	0x00	RW
[2:0]	ASRC_SOURCE	000 Not used 001 From serial input ports; select channels using Bits[7:3] (ASRC_SIN_CHANNEL) 010 From DSP core outputs 011 From S/PDIF receiver 100 From digital PDM Microphone Input Channel 0 and PDM Microphone Input Channel 1 101 From digital PDM Microphone Input Channel 2 and PDM Microphone Input Channel 3	ASRC source select.	0x0	RW

**ASRC Output Rate Selector Register**

Address: 0xF140 to Address 0xF147 (Increments of 0x1), Reset: 0x0000, Name: ASRC\_OUT\_RATEx

These eight registers configure the target output sample rates of the corresponding eight stereo ASRCs on the ADAU1452 and ADAU1451. The ASRC takes any arbitrary input sample rate and automatically attempts to resample the data in that signal and output it at the target sample rate as configured by these registers. Each of the eight registers corresponds to one of the eight stereo ASRCs. ASRC\_OUT\_RATE0 configures ASRC Channel 0 and ASRC Channel 1, ASRC\_OUT\_RATE1 configures ASRC Channel 2 and ASRC Channel 3, ASRC\_OUT\_RATE2 configures ASRC Channel 4 and ASRC Channel 5, ASRC\_OUT\_RATE3 configures ASRC Channel 6 and ASRC Channel 7, ASRC\_OUT\_RATE4 configures ASRC Channel 8 and ASRC Channel 9, ASRC\_OUT\_RATE5 configures ASRC Channel 10 and ASRC Channel 11, ASRC\_OUT\_RATE6 configures ASRC Channel 12 and ASRC Channel 13, and ASRC\_OUT\_RATE7 configures ASRC Channel 14 and ASRC Channel 15. The ASRCs lock their output frequencies to the audio sample rates of any of the serial output ports, the DSP start pulse rate of the core, or one of several internally generated sample rates coming from the clock generators.

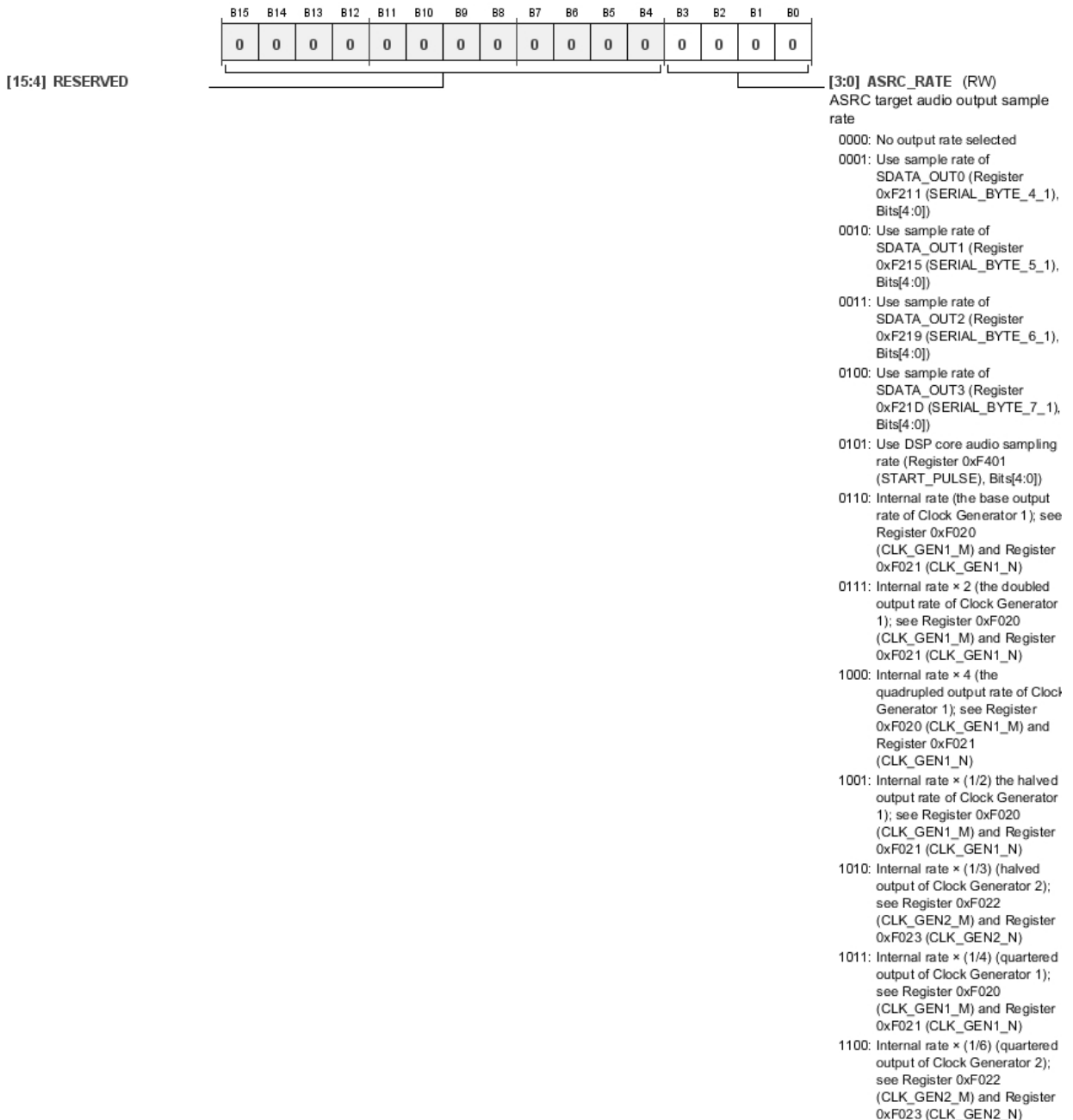

Table 83. Bit Descriptions for ASRC\_OUT\_RATEx

Bits	Bit Name	Settings	Description	Reset	Access
[15:4]	RESERVED			0x0	RW
[3:0]	ASRC_RATE		ASRC target audio output sample rate. The corresponding ASRC can lock its output to a serial output port, the DSP core, or an internally generated rate.	0x0	RW
		0000	No output rate selected		
		0001	Use sample rate of SDATA_OUT0 (Register 0xF211 (SERIAL_BYTE_4_1), Bits[4:0])		
		0010	Use sample rate of SDATA_OUT1 (Register 0xF215 (SERIAL_BYTE_5_1), Bits[4:0])		
		0011	Use sample rate of SDATA_OUT2 (Register 0xF219 (SERIAL_BYTE_6_1), Bits[4:0])		
		0100	Use sample rate of SDATA_OUT3 (Register 0xF21D (SERIAL_BYTE_7_1), Bits[4:0])		
		0101	Use DSP core audio sampling rate (Register 0xF401 (START_PULSE), Bits[4:0])		
		0110	Internal rate (the base output rate of Clock Generator 1); see Register 0xF020 (CLK_GEN1_M) and Register 0xF021 (CLK_GEN1_N)		
		0111	Internal rate × 2 (the doubled output rate of Clock Generator 1); see Register 0xF020 (CLK_GEN1_M) and Register 0xF021 (CLK_GEN1_N)		
		1000	Internal rate × 4 (the quadrupled output rate of Clock Generator 1); see Register 0xF020 (CLK_GEN1_M) and Register 0xF021 (CLK_GEN1_N)		
		1001	Internal rate × (1/2) the halved output rate of Clock Generator 1; see Register 0xF020 (CLK_GEN1_M) and Register 0xF021 (CLK_GEN1_N)		
		1010	Internal rate × (1/3) (halved output of Clock Generator 2); see Register 0xF022 (CLK_GEN2_M) and Register 0xF023 (CLK_GEN2_N)		
		1011	Internal rate × (1/4) (quartered output of Clock Generator 1); see Register 0xF020 (CLK_GEN1_M) and Register 0xF021 (CLK_GEN1_N)		
		1100	Internal rate × (1/6) (quartered output of Clock Generator 2); see Register 0xF022 (CLK_GEN2_M) and Register 0xF023 (CLK_GEN2_N)		



**Source of Data for Serial Output Ports Register**

**Address: 0xF180 to 0xF197 (Increments of 0x1), Reset: 0x0000, Name: SOUT\_SOURCEx**

These 24 registers correspond to the 24 pairs of output channels used by the serial output ports. Each register corresponds to two audio channels. SOUT\_SOURCE0 corresponds to Channel 0 and Channel 1, SOUT\_SOURCE1 corresponds to Channel 2 and Channel 3, and so on. SOUT\_SOURCE0 to SOUT\_SOURCE7 map to the 16 total channels (Channel 0 to Channel 15) that are fed to SDATA\_OUT0. SOUT\_SOURCE8 to SOUT\_SOURCE15 map to the 16 total channels (Channel 16 to Channel 31) that are fed to SDATA\_OUT1. SOUT\_SOURCE16 to SOUT\_SOURCE19 map to the eight total channels (Channel 32 to Channel 39) that are fed to SDATA\_OUT2. SOUT\_SOURCE20 to SOUT\_SOURCE23 map to the eight total channels (Channel 40 to Channel 47) that are fed to SDATA\_OUT3. Data originates from several places, including directly from the corresponding input audio channels from the serial input ports, from the corresponding audio output channels of the DSP core, from an ASRC output pair, or directly from the PDM microphone inputs.

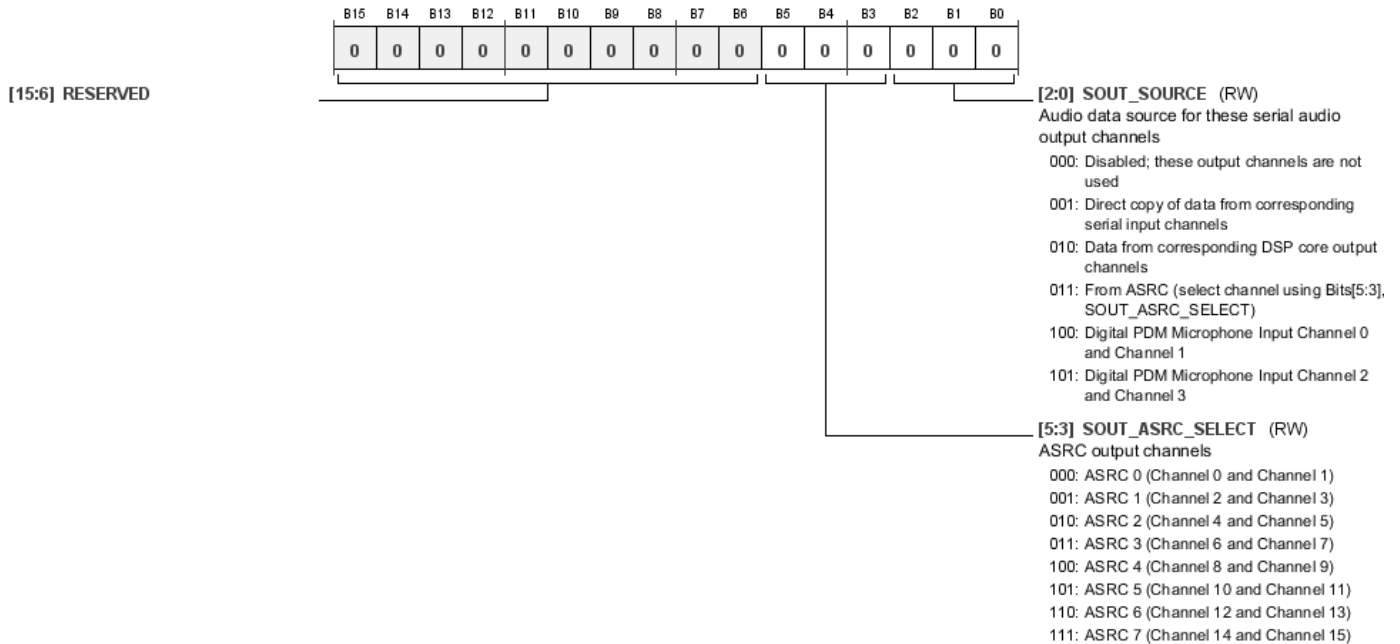

**Table 84. Bit Descriptions for SOUT\_SOURCEx**

Bits	Bit Name	Settings	Description	Reset	Access
[15:6]	RESERVED			0x000	RW
[5:3]	SOUT_ASRC_SELECT	000 001 010 011 100 101 110 111	ASRC output channels. If Bits[2:0] (SOUT_SOURCE) are set to 0b011, these bits select which ASRC channels are routed to the serial output channels. ASRC 0 (Channel 0 and Channel 1) on the <a href="#">ADAU1452</a> and <a href="#">ADAU1451</a> ASRC 1 (Channel 2 and Channel 3) on the <a href="#">ADAU1452</a> and <a href="#">ADAU1451</a> ASRC 2 (Channel 4 and Channel 5) on the <a href="#">ADAU1452</a> and <a href="#">ADAU1451</a> ASRC 3 (Channel 6 and Channel 7) on the <a href="#">ADAU1452</a> and <a href="#">ADAU1451</a> ASRC 4 (Channel 8 and Channel 9) on the <a href="#">ADAU1452</a> and <a href="#">ADAU1451</a> ASRC 5 (Channel 10 and Channel 11) on the <a href="#">ADAU1452</a> and <a href="#">ADAU1451</a> ASRC 6 (Channel 12 and Channel 13) on the <a href="#">ADAU1452</a> and <a href="#">ADAU1451</a> ASRC 7 (Channel 14 and Channel 15) on the <a href="#">ADAU1452</a> and <a href="#">ADAU1451</a>	0x0	RW

Bits	Bit Name	Settings	Description	Reset	Access
[2:0]	SOUT_SOURCE	000 Disabled; these output channels are not used 001 Direct copy of data from corresponding serial input channels 010 Data from corresponding DSP core output channels 011 From ASRC (select channel using Bits[5:3], SOUT_ASRC_SELECT) on the <a href="#">ADAU1452</a> and <a href="#">ADAU1451</a> 100 Digital PDM Microphone Input Channel 0 and Digital PDM Microphone Input Channel 1 101 Digital PDM Microphone Input Channel 2 and Digital PDM Microphone Input Channel 3	Audio data source for these serial audio output channels. If these bits are set to 0b001, the corresponding output channels output a copy of the data from the corresponding input channels. For example, if Address 0xF180, Bits[2:0] are set to 0b001, Serial Input Channel 0 and Serial Input Channel 1 copy to Serial Output Channel 0 and Serial Output Channel 1, respectively. If these bits are set to 0b010, DSP Output Channel 0 and DSP Output Channel 1 copy to Serial Output Channel 0 and Serial Output Channel 1, respectively. If these bits are set to 0b011, Bits[5:3] (SOUT_ASRC_SELECT) must be configured to select the desired ASRC output.	0x0	RW

**S/PDIF Transmitter Data Selector Register**

Address: 0xF1C0, Reset: 0x0000, Name: SPDIFTX\_INPUT

This register configures which data source feeds the S/PDIF transmitter on the [ADAU1452](#) and [ADAU1451](#). Data can originate from the S/PDIF outputs of the DSP core or directly from the S/PDIF receiver.

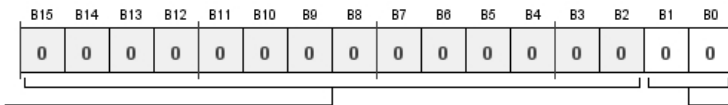

**[1:0] SPDIFTX\_SOURCE (RW)**  
 S/PDIF transmitter source  
 00: Disables S/PDIF transmitter  
 01: Data originates from S/PDIF Output Channel 0 and S/PDIF Output Channel 1 of the DSP core, as configured in the DSP program  
 10: Data copied directly from S/PDIF Receiver Channel 0 and S/PDIF Receiver Channel 1 to S/PDIF Transmitter Channel 0 and S/PDIF Transmitter Channel 1, respectively

**Table 85. Bit Descriptions for SPDIFTX\_INPUT**

Bits	Bit Name	Settings	Description	Reset	Access
[15:2]	RESERVED			0x0	RW
[1:0]	SPDIFTX_SOURCE	00 Disables S/PDIF transmitter 01 Data originates from S/PDIF Output Channel 0 and S/PDIF Output Channel 1 of the DSP core, as configured in the DSP program 10 Data copied directly from S/PDIF Receiver Channel 0 and S/PDIF Receiver Channel 1 to S/PDIF Transmitter Channel 0 and S/PDIF Transmitter Channel 1, respectively	S/PDIF transmitter source.	0x0	RW

**SERIAL PORT CONFIGURATION REGISTERS**

**Serial Port Control 0 Register**

Address: 0xF200 to 0xF21C (Increments of 0x4), Reset: 0x0000, Name: SERIAL\_BYTE\_x\_0

These eight registers configure several settings for the corresponding serial input and serial output ports. Channel count, MSB position, data-word length, clock polarity, clock sources, and clock type are configured using these registers. On the input side, Register 0xF200 (SERIAL\_BYTE\_0\_0) corresponds to SDATA\_IN0; Register 0xF204 (SERIAL\_BYTE\_1\_0) corresponds to SDATA\_IN1; Register 0xF208 (SERIAL\_BYTE\_2\_0) corresponds to SDATA\_IN2; and Register 0xF20C (SERIAL\_BYTE\_3\_0) corresponds to SDATA\_IN3. On the output side, Register 0xF210 (SERIAL\_BYTE\_4\_0) corresponds to SDATA\_OUT0; Register 0xF214 (SERIAL\_BYTE\_5\_0) corresponds to SDATA\_OUT1; Register 0xF218 (SERIAL\_BYTE\_6\_0) corresponds to SDATA\_OUT2; and Register 0xF21C (SERIAL\_BYTE\_7\_0) corresponds to SDATA\_OUT3.

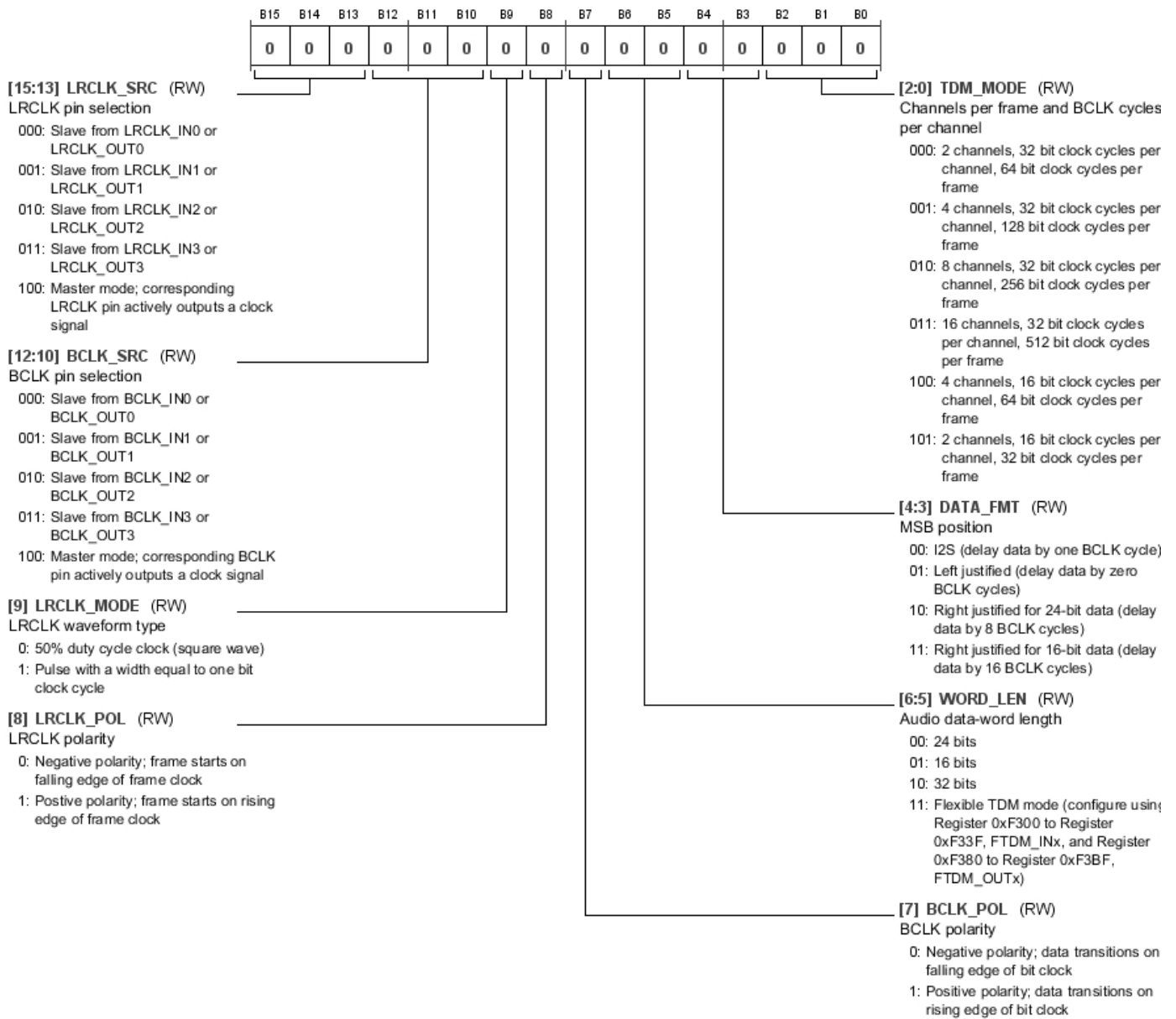

Table 86. Bit Descriptions for SERIAL\_BYTE\_x\_0

Bits	Bit Name	Settings	Description	Reset	Access
[15:13]	LRCLK_SRC	<p>000 Slave from LRCLK_IN0 or LRCLK_OUT0</p> <p>001 Slave from LRCLK_IN1 or LRCLK_OUT1</p> <p>010 Slave from LRCLK_IN2 or LRCLK_OUT2</p> <p>011 Slave from LRCLK_IN3 or LRCLK_OUT3</p> <p>100 Master mode; corresponding LRCLK pin actively outputs a clock signal</p>	LRCLK pin selection. These bits configure whether the corresponding serial port is a frame clock master or slave. When configured as a master, the corresponding LRCLK pin (LRCLK_INx for SDATA_IN pins and LRCLK_OUTx for SDATA_OUT pins) with the same number as the serial port (for example, LRCLK_OUT0 for SDATA_OUT0) actively drives out a clock signal. When configured as a slave, the serial port can receive its clock signal from any of the four corresponding LRCLK pins (LRCLK_INx pins for SDATA_INx pins or LRCLK_OUTx pins for SDATA_OUTx pins).	0x0	RW
[12:10]	BCLK_SRC	<p>000 Slave from BCLK_IN0 or BCLK_OUT0</p> <p>001 Slave from BCLK_IN1 or BCLK_OUT1</p> <p>010 Slave from BCLK_IN2 or BCLK_OUT2</p> <p>011 Slave from BCLK_IN3 or BCLK_OUT3</p> <p>100 Master mode; corresponding BCLK pin actively outputs a clock signal</p>	BCLK pin selection. These bits configure whether the corresponding serial port is a bit clock master or slave. When configured as a master, the corresponding BCLK pin (BCLK_INx for SDATA_INx pins and BCLK_OUTx for SDATA_OUTx pins) with the same number as the serial port (for example, BCLK_OUT0 for SDATA_OUT0) actively drives out a clock signal. When configured as a slave, the serial port can receive its clock signal from any of the four corresponding BCLK pins (BCLK_INx pins for SDATA_INx pins or BCLK_OUTx pins for SDATA_OUTx pins).	0x0	RW
9	LRCLK_MODE	<p>0 50% duty cycle clock (square wave)</p> <p>1 Pulse with a width equal to one bit clock cycle</p>	LRCLK waveform type. The frame clock can be a 50/50 duty cycle square wave or a short pulse.	0x0	RW
8	LRCLK_POL	<p>0 Negative polarity; frame starts on falling edge of frame clock</p> <p>1 Positive polarity; frame starts on rising edge of frame clock</p>	LRCLK polarity. This bit sets the frame clock polarity on the corresponding serial port. Negative polarity means that the frame starts on the falling edge of the frame clock. This conforms to the I <sup>2</sup> S standard audio format.	0x0	RW
7	BCLK_POL	<p>0 Negative polarity; data transitions on falling edge of bit clock</p> <p>1 Positive polarity; data transitions on rising edge of bit clock</p>	BCLK polarity. This bit sets the bit clock polarity on the corresponding serial port. Negative polarity means that the data signal transitions on the falling edge of the bit clock. This conforms to the I <sup>2</sup> S standard audio format.	0x0	RW
[6:5]	WORD_LEN	<p>00 24 bits</p> <p>01 16 bits</p> <p>10 32 bits</p> <p>11 Flexible TDM mode (configure using Register 0xF300 to Register 0xF33F, FTDM_INx, and Register 0xF380 to Register 0xF3BF, FTDM_OUTx)</p>	Audio data-word length. These bits set the word length of the audio data channels on the corresponding serial port. For serial input ports, if the input data has more words than the length as configured by these bits, the extra data bits are ignored. For output serial ports, if the word length, as configured by these bits, is shorter than the data length coming from the data source (the DSP, ASRCs, S/PDIF receiver, PDM inputs, or serial inputs), the extra data bits are truncated and output as 0s. If Bits[6:5] (WORD_LEN) are set to 0b10 for 32-bit mode, the corresponding 32-bit input or output cells are required in SigmaStudio.	0x0	RW

Bits	Bit Name	Settings	Description	Reset	Access
[4:3]	DATA_FMT	00 01 10 11	MSB position. These bits set the positioning of the data in the frame on the corresponding serial port. 00 I <sup>2</sup> S (delay data by one BCLK cycle) 01 Left justified (delay data by zero BCLK cycles) 10 Right justified for 24-bit data (delay data by 8 BCLK cycles) 11 Right justified for 16-bit data (delay data by 16 BCLK cycles)	0x0	RW
[2:0]	TDM_MODE	000 001 010 011 100 101	Channels per frame and BCLK cycles per channel. These bits set the number of channels per frame and the number of bit clock cycles per frame on the corresponding serial port. 000 2 channels, 32 bit clock cycles per channel, 64 bit clock cycles per frame 001 4 channels, 32 bit clock cycles per channel, 128 bit clock cycles per frame 010 8 channels, 32 bit clock cycles per channel, 256 bit clock cycles per frame 011 16 channels, 32 bit clock cycles per channel, 512 bit clock cycles per frame 100 4 channels, 16 bit clock cycles per channel, 64 bit clock cycles per frame 101 2 channels, 16 bit clock cycles per channel, 32 bit clock cycles per frame	0x0	RW

**Serial Port Control 1 Register**

Address: 0xF201 to 0xF21D (Increments of 0x4), Reset: 0x0002, Name: SERIAL\_BYTE\_x\_1

These eight registers configure several settings for the corresponding serial input and serial output ports. Clock generator, sample rate, and behavior during inactive channels are configured with these registers. On the input side, Register 0xF201 (SERIAL\_BYTE\_0\_1) corresponds to SDATA\_IN0; Register 0xF205 (SERIAL\_BYTE\_1\_1) corresponds to SDATA\_IN1; Register 0xF209 (SERIAL\_BYTE\_2\_1) corresponds to SDATA\_IN2; and Register 0xF20D (SERIAL\_BYTE\_3\_1) corresponds to SDATA\_IN3. On the output side, Register 0xF211 (SERIAL\_BYTE\_4\_1) corresponds to SDATA\_OUT0; Register 0xF215 (SERIAL\_BYTE\_5\_1) corresponds to SDATA\_OUT1; Register 0xF219 (SERIAL\_BYTE\_6\_1) corresponds to SDATA\_OUT2; and Register 0xF21D (SERIAL\_BYTE\_7\_1) corresponds to SDATA\_OUT3.

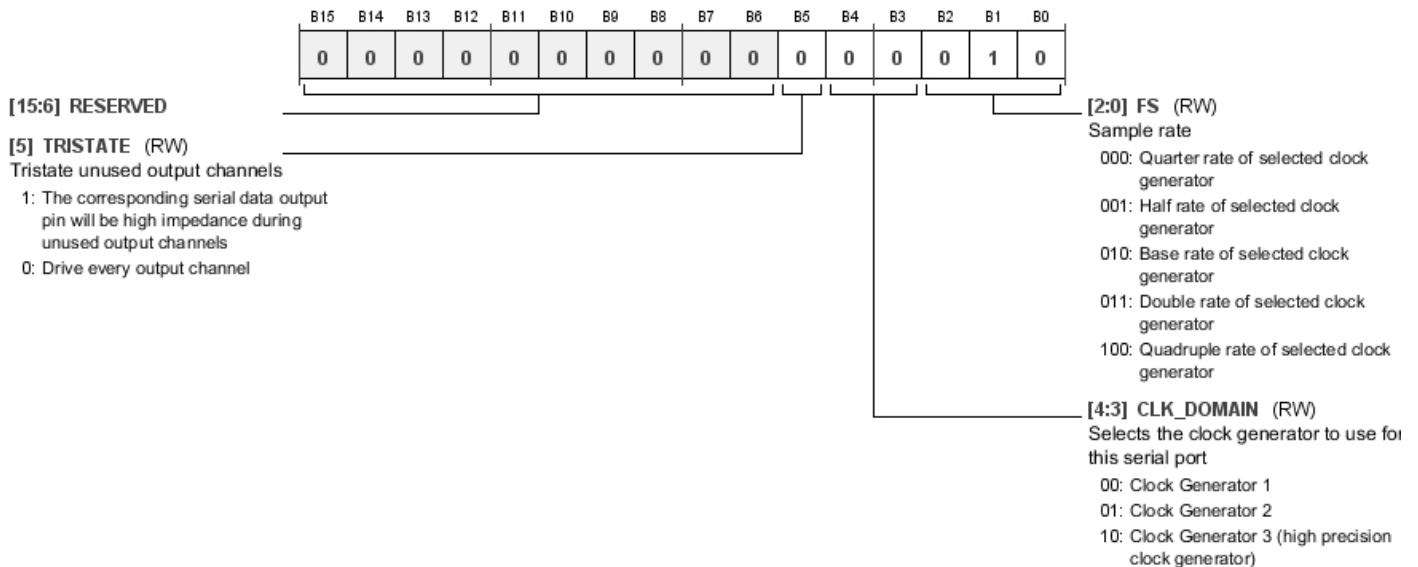

Table 87. Bit Descriptions for SERIAL\_BYTE\_x\_1

Bits	Bit Name	Settings	Description	Reset	Access
[15:6]	RESERVED			0x000	RW
5	TRISTATE	1 0	Tristate unused output channels. This bit has no effect on serial input ports. 1 The corresponding serial data output pin is high impedance during unused output channels 0 Drive every output channel	0x0	RW

Bits	Bit Name	Settings	Description	Reset	Access
[4:3]	CLK_DOMAIN	00 01 10	Selects the clock generator to use for the serial port. These bits select the clock generator to use for this serial port when it is configured as a clock master. This setting is valid only when Bits[15:13] (LRCLK_SRC) of the corresponding SERIAL_BYTE_x_0 register are set to 0b100 (master mode) and Bits[12:10] (BCLK_SRC) are set to 0b100 (master mode). Clock Generator 1 Clock Generator 2 Clock Generator 3 (high precision clock generator)	0x0	RW
[2:0]	FS	000 001 010 011 100	Sample rate. These bits set the sample rate to use for the serial port when it is configured as a clock master. This setting is valid only when Bits[15:13] (LRCLK_SRC) of the corresponding SERIAL_BYTE_x_0 register are set to 0b100 (master mode) and Bits[12:10] BCLK_SRC are set to 0b100 (master mode). Bits[4:3] (CLK_DOMAIN) select which clock generator to use, and Bits[2:0] (FS) select which of the five clock generator outputs to use. Quarter rate of selected clock generator Half rate of selected clock generator Base rate of selected clock generator Double rate of selected clock generator Quadruple rate of selected clock generator	0x2	RW

## FLEXIBLE TDM INTERFACE REGISTERS

### FTDM Mapping for the Serial Inputs Register

Address: 0xF300 to 0xF33F (Increments of 0x1), Reset: 0x0000, Name: FTDM\_INx

These 64 registers correspond to the 64 bytes of data that combine to form the 16 audio channels derived from the data streams being input to the SDATA\_IN2 and SDATA\_IN3 pins.

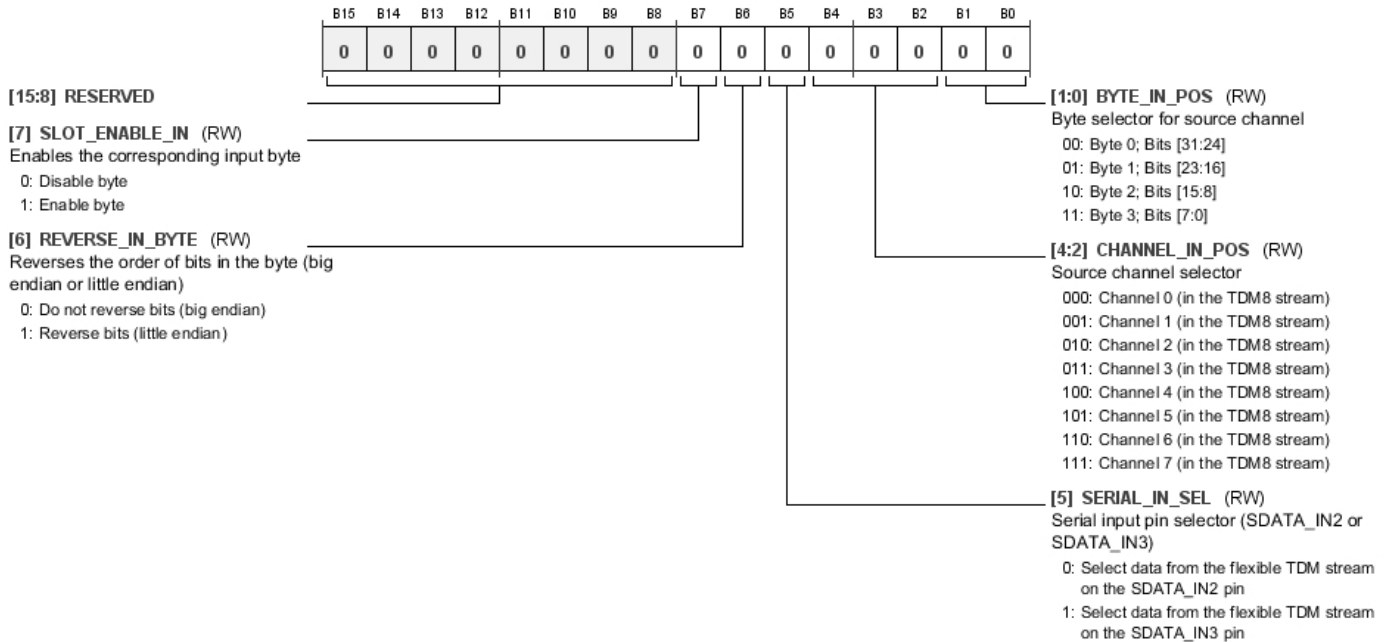

Table 88. Bit Descriptions for FTDM\_INx

Bits	Bit Name	Settings	Description	Reset	Access
[15:8]	RESERVED			0x0	RW
7	SLOT_ENABLE_IN	0 1	Enables the corresponding input byte. This bit determines whether or not the slot is active. If active, valid data is input from the corresponding data slot on the selected channel of the selected input pin. If disabled, input data from the corresponding data slot on the selected channel of the selected input pin is ignored. 0 Disable byte 1 Enable byte	0x0	RW
6	REVERSE_IN_BYTE	0 1	Reverses the order of bits in the byte (big endian or little endian). This bit changes the endianness of the data bits within the byte by optionally reversing the order of the bits from MSB to LSB. 0 Do not reverse bits (big endian) 1 Reverse bits (little endian)	0x0	RW
5	SERIAL_IN_SEL	0 1	Serial input pin selector (SDATA_IN2 or SDATA_IN3). If this bit = 0b0, the slot is mapped to Audio Channel 32 to Audio Channel 39. If this bit = 0b1, the slot is mapped to Audio Channel 40 to Audio Channel 47. The exact channel assignment is determined by Bits[4:2] (CHANNEL_IN_POS). 0 Select data from the flexible TDM stream on the SDATA_IN2 pin 1 Select data from the flexible TDM stream on the SDATA_IN3 pin	0x0	RW
[4:2]	CHANNEL_IN_POS	000 001 010 011 100 101 110 111	Source channel selector. These bits map the slot to an audio input channel. If Bit 5 (SERIAL_IN_SEL) = 0b0, Position 0 maps to Channel 32, Position 1 maps to Channel 33, and so on. . If Bit 5 (SERIAL_IN_SEL) = 0b1, Position 0 maps to Channel 40, Position 1 maps to Channel 41, and so on. 000 Channel 0 (in the TDM8 stream) 001 Channel 1 (in the TDM8 stream) 010 Channel 2 (in the TDM8 stream) 011 Channel 3 (in the TDM8 stream) 100 Channel 4 (in the TDM8 stream) 101 Channel 5 (in the TDM8 stream) 110 Channel 6 (in the TDM8 stream) 111 Channel 7 (in the TDM8 stream)	0x0	RW
[1:0]	BYTE_IN_POS	00 01 10 11	Byte selector for source channel. These bits determine which byte the slot fills in the channel selected by Bit 5 (SERIAL_IN_SEL) and Bits[4:2] (CHANNEL_IN_POS). Each channel consists of four bytes that are selectable by the four options available in this bit field. 00 Byte 0; Bits[31:24] 01 Byte 1; Bits[23:16] 10 Byte 2; Bits[15:8] 11 Byte 3; Bits[7:0]	0x0	RW

**FTDM Mapping for the Serial Outputs Register**

Address: 0xF380 to 0xF3BF (Increments of 0x1), Reset: 0x0000, Name: FTDM\_OUTx

These 64 registers correspond to the 64 data slots for the flexible TDM output modes on the SDATA\_OUT2 and SDATA\_OUT3 pins. Slot 0 to Slot 31 are available for use on SDATA\_OUT2, and Slot 32 to Slot 63 are available for use on SDATA\_OUT3. Each slot can potentially hold one byte of data. Slots are mapped to corresponding audio channels in the serial ports by Bits[5:0] in these registers.

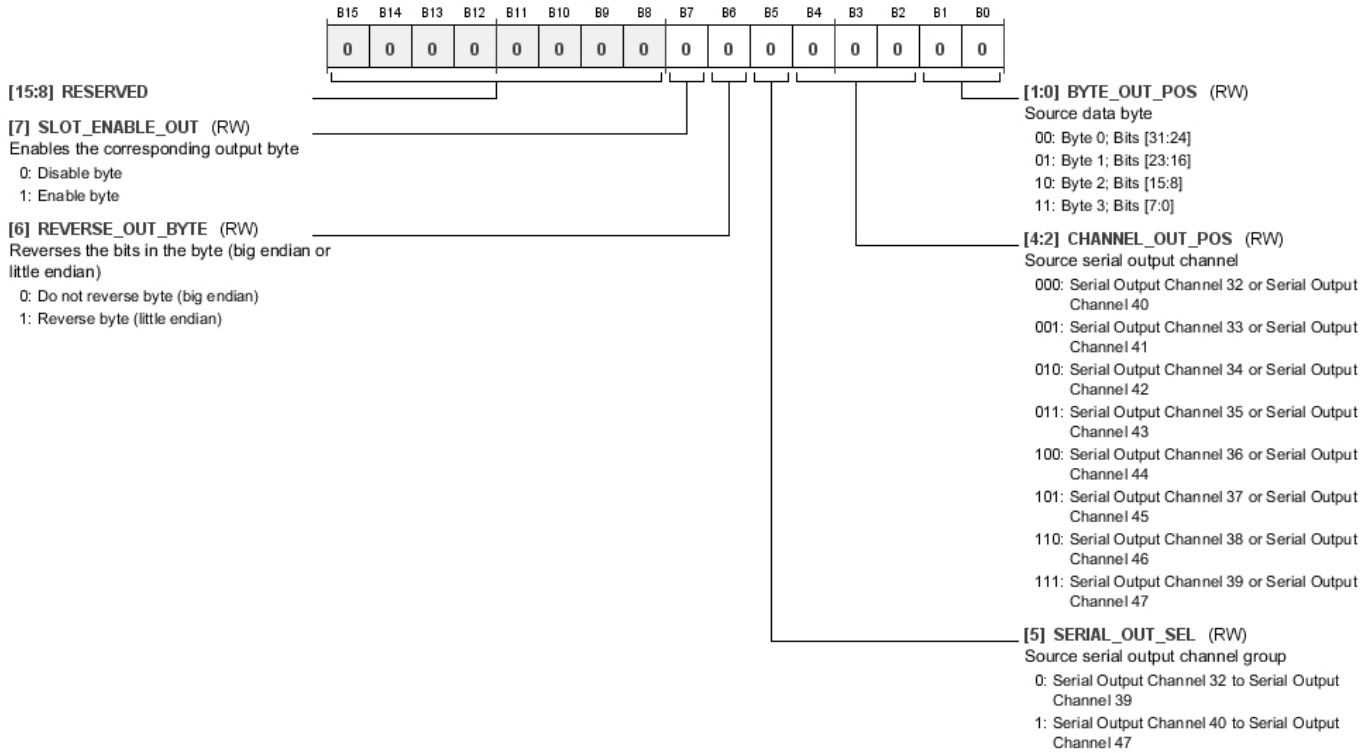

**Table 89. Bit Descriptions for FTDM\_OUTx**

Bits	Bit Name	Settings	Description	Reset	Access
[15:8]	RESERVED			0x0	RW
7	SLOT_ENABLE_OUT	0 1	Enables the corresponding output byte. This bit determines whether or not the slot is active. If Bit 7 (SLOT_ENABLE_OUT) = 0b0 and Bit 5 (TRISTATE) of the corresponding serial output port = 0b1, the corresponding output pin is high impedance during the period in which the corresponding flexible TDM slot is output. If Bit 7 (SLOT_ENABLE_OUT) = 0b0, and Bit 5 (TRISTATE) of the corresponding serial output port = 0b0, the corresponding output pin drives logic low during the period in which the corresponding flexible TDM slot is output. If Bit 7 (SLOT_ENABLE_OUT) = 0b1, the corresponding serial output pin outputs valid data during the period in which the corresponding flexible TDM slot is output.	0x0	RW
6	REVERSE_OUT_BYTE	0 1	Reverses the bits in the byte (big endian or little endian). This bit changes the endianness of the data bits within the corresponding flexible TDM slot by optionally reversing the order of the bits from MSB to LSB. 0: Do not reverse byte (big endian) 1: Reverse byte (little endian)	0x0	RW
5	SERIAL_OUT_SEL	0 1	Source serial output channel group. This bit, together with Bits[4:2] (CHANNEL_OUT_POS), selects which serial output channel is the source of data for the corresponding flexible TDM output slot. 0: Serial Output Channel 32 to Serial Output Channel 39 1: Serial Output Channel 40 to Serial Output Channel 47	0x0	RW



Bits	Bit Name	Settings	Description	Reset	Access
[4:2]	CHANNEL_OUT_POS	000 001 010 011 100 101 110 111	Source serial output channel. These bits, along with Bit 5 (SERIAL_OUT_SEL), select which serial output channel is the source of data for the corresponding flexible TDM output slot. If Bit 5 (SERIAL_OUT_SEL) = 0b0, Bits[4:2] (CHANNEL_OUT_POS) select serial output channels between Serial Output Channel 32 and Serial Output Channel 39. If Bit 5 (SERIAL_OUT_SEL) = 0b1, Bits[4:2] (CHANNEL_OUT_POS) selects serial output channels between Serial Output Channel 40 and Serial Output Channel 47.	0x0	RW
[1:0]	BYTE_OUT_POS	00 01 10 11	Source data byte. These bits determine which data byte is used from the corresponding serial output channel (selected by setting Bit 5 (SERIAL_OUT_SEL) and Bits[4:2] (CHANNEL_OUT_POS)). Because there can be up to 32 bits in the data-word, four bytes are available.	0x0	RW

**DSP CORE CONTROL REGISTERS**

***Hibernate Setting Register***

Address: 0xF400, Reset: 0x0000, Name: HIBERNATE

When hibernation mode is activated, the DSP core continues processing the current audio sample or block, and then enters a low power hibernation state. If Bit 0 (HIBERNATE) is set to 0b1 when the DSP core is processing audio, wait at least the duration of one sample before attempting to modify any other control registers. If Bit 0 (HIBERNATE) is set to 0b1 when the DSP core is processing audio, and block processing is used in the signal flow, wait at least the duration of one block plus the duration of one sample before attempting to modify any other control registers. During hibernation, interrupts to the core are disabled. This prevents audio from flowing into or out of the DSP core. Because DSP processing ceases when hibernation is active, there is a significant drop in the current consumption on the DVDD supply.

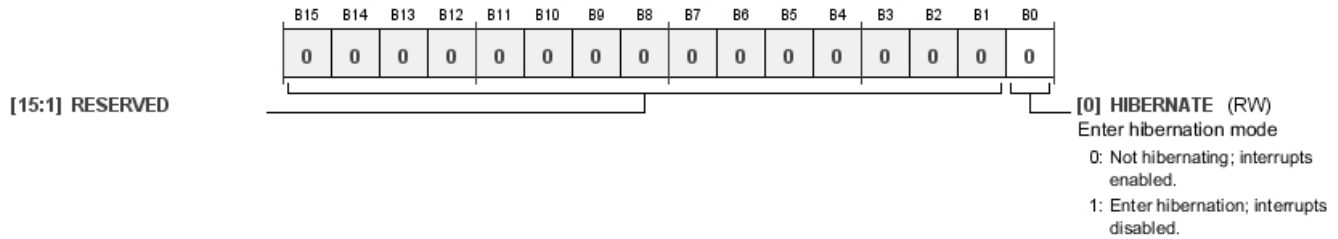

**Table 90. Bit Descriptions for Hibernate**

Bits	Bit Name	Settings	Description	Reset	Access
[15:1]	RESERVED			0x0	RW
0	HIBERNATE	0 1	Enter hibernation mode. This bit disables incoming interrupts and tells the DSP core to go to a low power sleep mode after the next audio sample or block has finished processing. It causes the DSP to enter hibernation mode by masking all interrupts. Not hibernating; interrupts enabled. Enter hibernation; interrupts disabled.	0x0	RW

**Start Pulse Selection Register**

Address: 0xF401, Reset: 0x0002, Name: START\_PULSE

This register selects the start pulse that marks the beginning of each audio frame in the DSP core. This effectively sets the sample rate of the audio going through the DSP. This start pulse can originate from either an internally generated pulse (from Clock Generator 1 or Clock Generator 2) or from an external clock that is received on one of the LRCLK pins of one of the serial ports. Any audio input or output from the DSP core that is asynchronous to this DSP start pulse rate must go through an ASRC. If asynchronous audio signals (that is, signals that are not synchronized to whatever start pulse is selected) are input to the DSP without first going through an ASRC, samples are skipped or doubled, leading to distortion and audible artifacts in the audio signal.

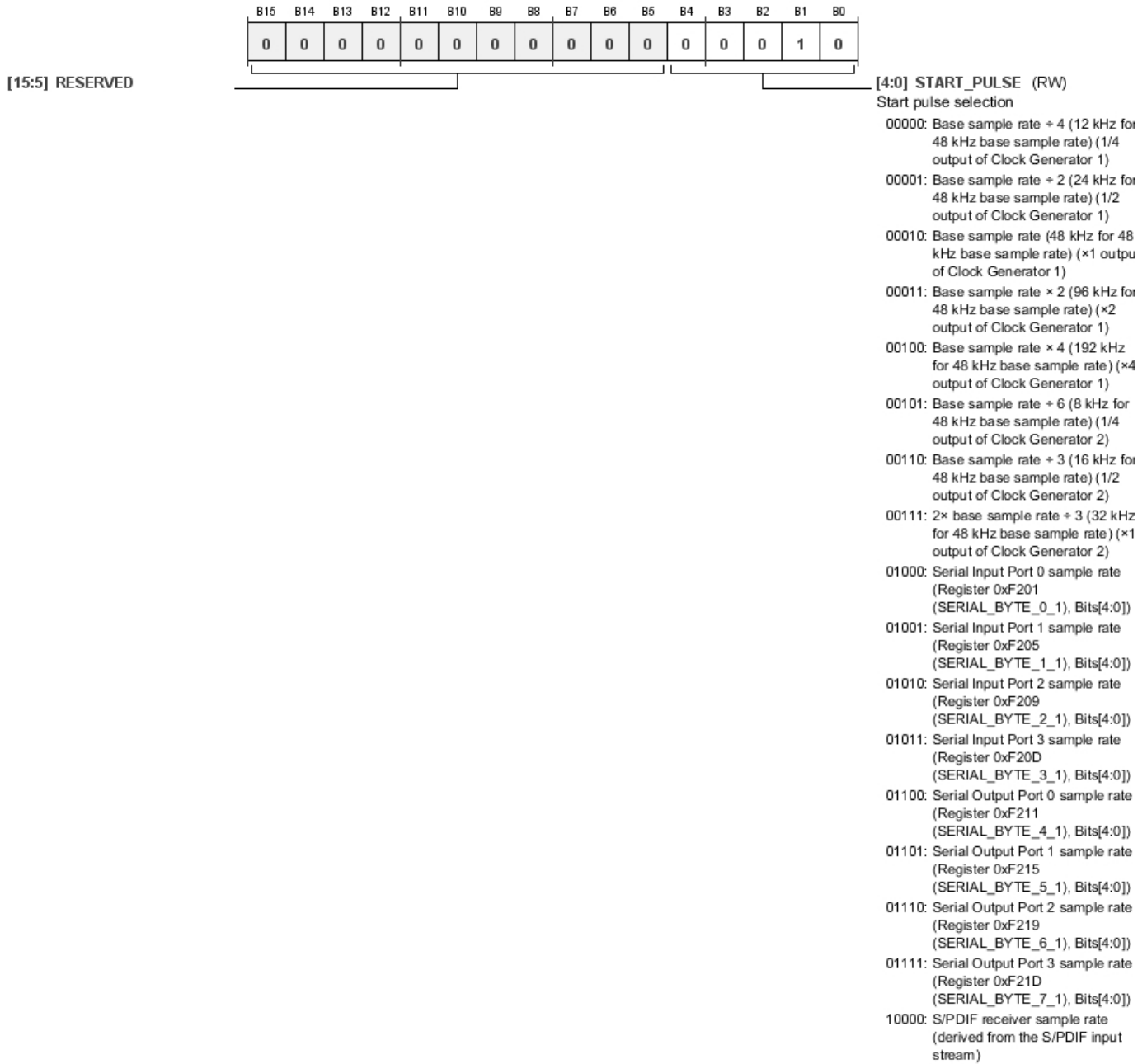

**Table 91. Bit Descriptions for START\_PULSE**

Bits	Bit Name	Settings	Description	Reset	Access
[15:5]	RESERVED			0x0	RW
[4:0]	START_PULSE	00000 Base sample rate ÷ 4 (12 kHz for 48 kHz base sample rate) (1/4 output of Clock Generator 1) 00001 Base sample rate ÷ 2 (24 kHz for 48 kHz base sample rate) (1/2 output of Clock Generator 1) 00010 Base sample rate (48 kHz for 48 kHz base sample rate) (×1 output of Clock Generator 1) 00011 Base sample rate × 2 (96 kHz for 48 kHz base sample rate) (×2 output of Clock Generator 1) 00100 Base sample rate × 4 (192 kHz for 48 kHz base sample rate) (×4 output of Clock Generator 1) 00101 Base sample rate ÷ 6 (8 kHz for 48 kHz base sample rate) (1/4 output of Clock Generator 2) 00110 Base sample rate ÷ 3 (16 kHz for 48 kHz base sample rate) (1/2 output of Clock Generator 2) 00111 2× base sample rate ÷ 3 (32 kHz for 48 kHz base sample rate) (×1 output of Clock Generator 2) 01000 Serial Input Port 0 sample rate (Register 0xF201 (SERIAL_BYTE_0_1), Bits[4:0]) 01001 Serial Input Port 1 sample rate (Register 0xF205 (SERIAL_BYTE_1_1), Bits[4:0]) 01010 Serial Input Port 2 sample rate (Register 0xF209 (SERIAL_BYTE_2_1), Bits[4:0]) 01011 Serial Input Port 3 sample rate (Register 0xF20D (SERIAL_BYTE_3_1), Bits[4:0]) 01100 Serial Output Port 0 sample rate (Register 0xF211 (SERIAL_BYTE_4_1), Bits[4:0]) 01101 Serial Output Port 1 sample rate (Register 0xF215 (SERIAL_BYTE_5_1), Bits[4:0]) 01110 Serial Output Port 2 sample rate (Register 0xF219 (SERIAL_BYTE_6_1), Bits[4:0]) 01111 Serial Output Port 3 sample rate (Register 0xF21D (SERIAL_BYTE_7_1), Bits[4:0]) 10000 S/PDIF receiver sample rate (derived from the S/PDIF input stream)	0x02	RW	

### Instruction to Start the Core Register

**Address: 0xF402, Reset: 0x0000, Name: START\_CORE**

Enables the DSP core and initiates the program counter, which then begins incrementing through the program memory and executing instruction codes. This register is edge triggered, meaning that a rising edge on Bit 0 (START\_CORE), that is, a transition from 0b0 to 0b1, initiates the program counter. A falling edge on Bit 0 (START\_CORE), that is, a transition from 0b1 to 0b0, has no effect. To stop the DSP core, use Register 0xF400 (HIBERNATE), Bit 0 (HIBERNATE).

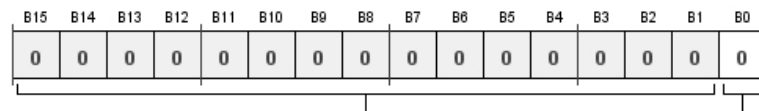

**[0] START\_CORE (RW)**  
 A transition of this bit from 0b0 to 0b1 enables the DSP core to start executing its program. A transition from 0b1 to 0b0 does not affect the DSP core.  
 0: A transition from 0b0 to 0b1 enables the DSP core to start program execution  
 1: A transition from 0b1 to 0b0 does not affect the DSP core

**Table 92. Bit Descriptions for START\_CORE**

Bits	Bit Name	Settings	Description	Reset	Access
[15:1]	RESERVED			0x0	RW

Bits	Bit Name	Settings	Description	Reset	Access
0	START_CORE		A transition of this bit from 0b0 to 0b1 enables the DSP core to start executing its program. A transition from 0b1 to 0b0 does not affect the DSP core.	0x0	RW
		0	A transition from 0b0 to 0b1 enables the DSP core to start program execution		
		1	A transition from 0b1 to 0b0 does not affect the DSP core		

**Instruction to Stop the Core Register**

Address: 0xF403, Reset: 0x0000, Name: KILL\_CORE

Bit 0 (KILL\_CORE) halts the DSP core immediately, even when it is in an undefined state. Because halting the DSP core immediately can lead to memory corruption, and it must be used only in debugging situations. This register is edge triggered, meaning that a rising edge on Bit 0 (KILL\_CORE), that is, a transition from 0b0 to 0b1, halts the core. A falling edge on Bit 0 (KILL\_CORE), that is, a transition from 0b1 to 0b0, has no effect. To stop the DSP core after the next audio frame or block, use Register 0xF400 (HIBERNATE), Bit 0 (HIBERNATE).

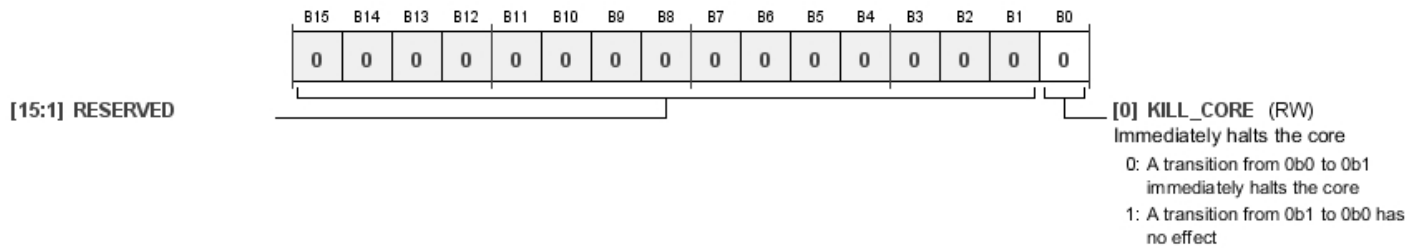

Table 93. Bit Descriptions for KILL\_CORE

Bits	Bit Name	Settings	Description	Reset	Access
[15:1]	RESERVED			0x0	RW
0	KILL_CORE		Immediately halts the core. When this bit transitions from 0b0 to 0b1, the core immediately halts. This can bring about undesired effects and, therefore, should be used only in debugging. To stop the core while it is running, use Register 0xF400 (HIBERNATE) to halt the core in a controlled manner.	0x0	RW
		0	A transition from 0b0 to 0b1 immediately halts the core		
		1	A transition from 0b1 to 0b0 has no effect		

**Start Address of the Program Register**

Address: 0xF404, Reset: 0x0000, Name: START\_ADDRESS

This register sets the program address where the program counter begins after the DSP core is enabled, using Register 0xF402, Bit 0 (START\_CORE). The SigmaStudio compiler automatically sets the program start address; therefore, the user is not required to manually modify the value of this register.



Table 94. Bit Descriptions for START\_ADDRESS

Bits	Bit Name	Settings	Description	Reset	Access
[15:0]	START_ADDRESS		Program start address.	0x0000	RW

**Core Status Register**

Address: 0xF405, Reset: 0x0000, Name: CORE\_STATUS

This read only register allows the user to check the status of the DSP core. To manually modify the core status, use Register 0xF400 (HIBERNATE), Register 0xF402 (START\_CORE), and Register 0xF403 (KILL\_CORE).

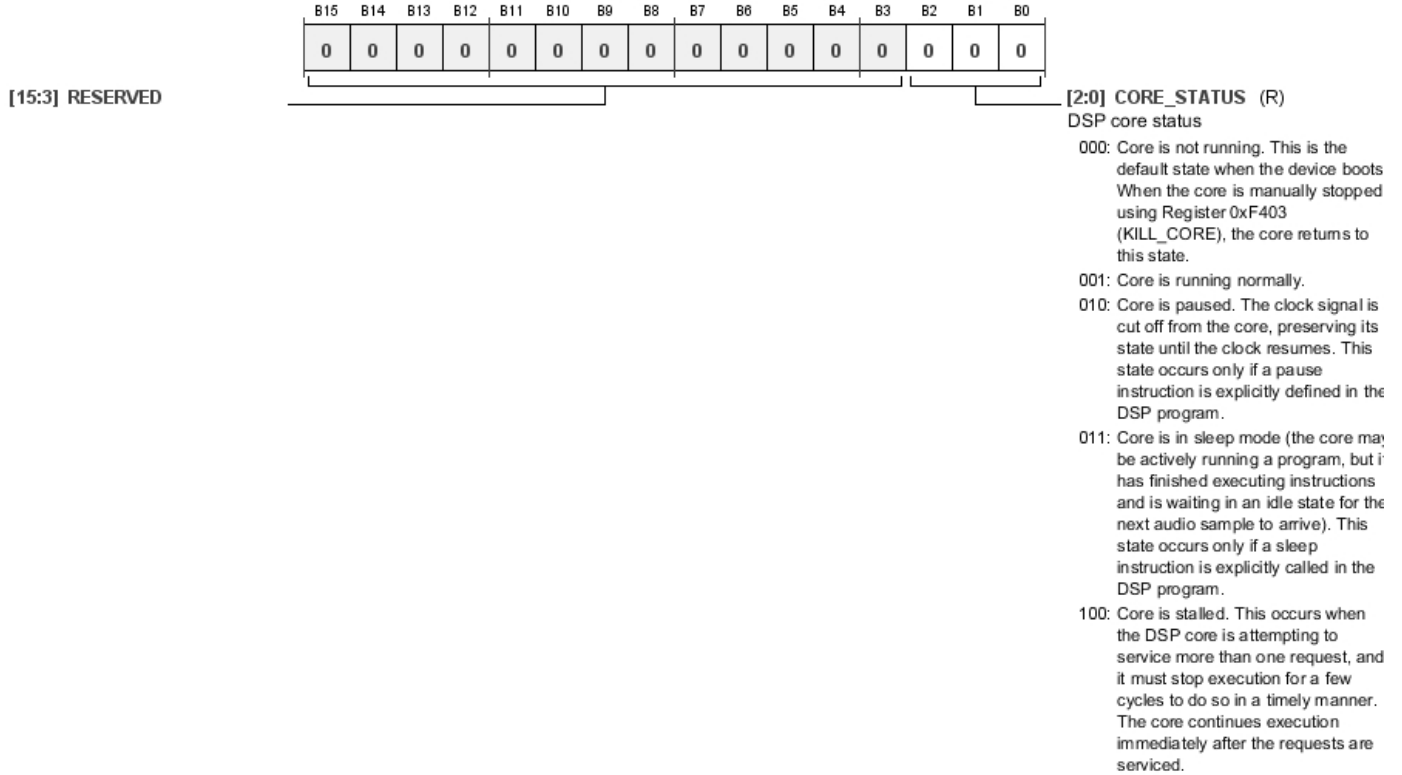

**Table 95. Bit Descriptions for CORE\_STATUS**

Bits	Bit Name	Settings	Description	Reset	Access
[15:3]	RESERVED			0x0	RW
[2:0]	CORE_STATUS		DSP core status. These bits display the status of the DSP core at the moment the value is read.	0x0	RW
		000	Core is not running. This is the default state when the device boots. When the core is manually stopped using Register 0xF403 (KILL_CORE), the core returns to this state.		
		001	Core is running normally.		
		010	Core is paused. The clock signal is cut off from the core, preserving its state until the clock resumes. This state occurs only if a pause instruction is explicitly defined in the DSP program.		
		011	Core is in sleep mode (the core may be actively running a program, but it has finished executing instructions and is waiting in an idle state for the next audio sample to arrive). This state occurs only if a sleep instruction is explicitly called in the DSP program.		
		100	Core is stalled. This occurs when the DSP core is attempting to service more than one request, and it must stop execution for a few cycles to do so in a timely manner. The core continues execution immediately after the requests are serviced.		

**DEBUG AND RELIABILITY REGISTERS****Clear the Panic Manager Register**

Address: 0xF421, Reset: 0x0000, Name: PANIC\_CLEAR

When Register 0xF427 (PANIC\_FLAG) signals that an error has occurred, use Register 0xF421 (PANIC\_CLEAR) to reset it. Toggle Bit 0 (PANIC\_CLEAR) of this register from 0b0 to 0b1 and then back to 0b0 again to clear the flag and reset the state of the panic manager.

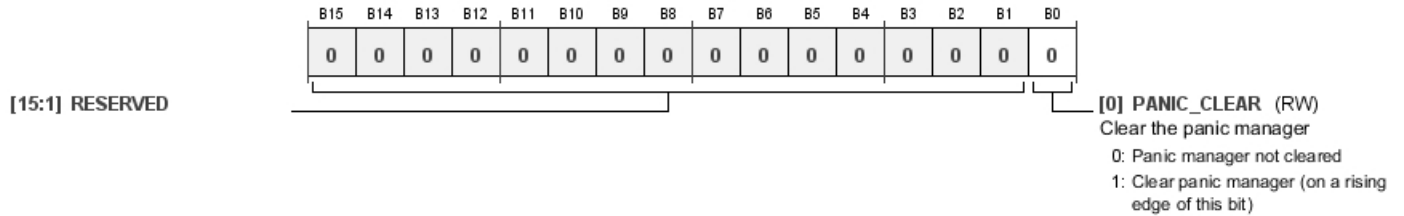
**Table 96. Bit Descriptions for PANIC\_CLEAR**

Bits	Bit Name	Settings	Description	Reset	Access
[15:1]	RESERVED			0x0	RW
0	PANIC_CLEAR	0 1	Clear the panic manager. To reset the PANIC_FLAG register, toggle this bit on and then off again. Panic manager is not cleared Clear panic manager (on a rising edge of this bit)	0x0	RW

**Panic Parity Register**

Address: 0xF422, Reset: 0x0003, Name: PANIC\_PARITY\_MASK

The panic manager checks and reports memory parity mask errors. Register 0xF422 (PANIC\_PARITY\_MASK) allows the user to configure which memories, if any, should be subject to error reporting.

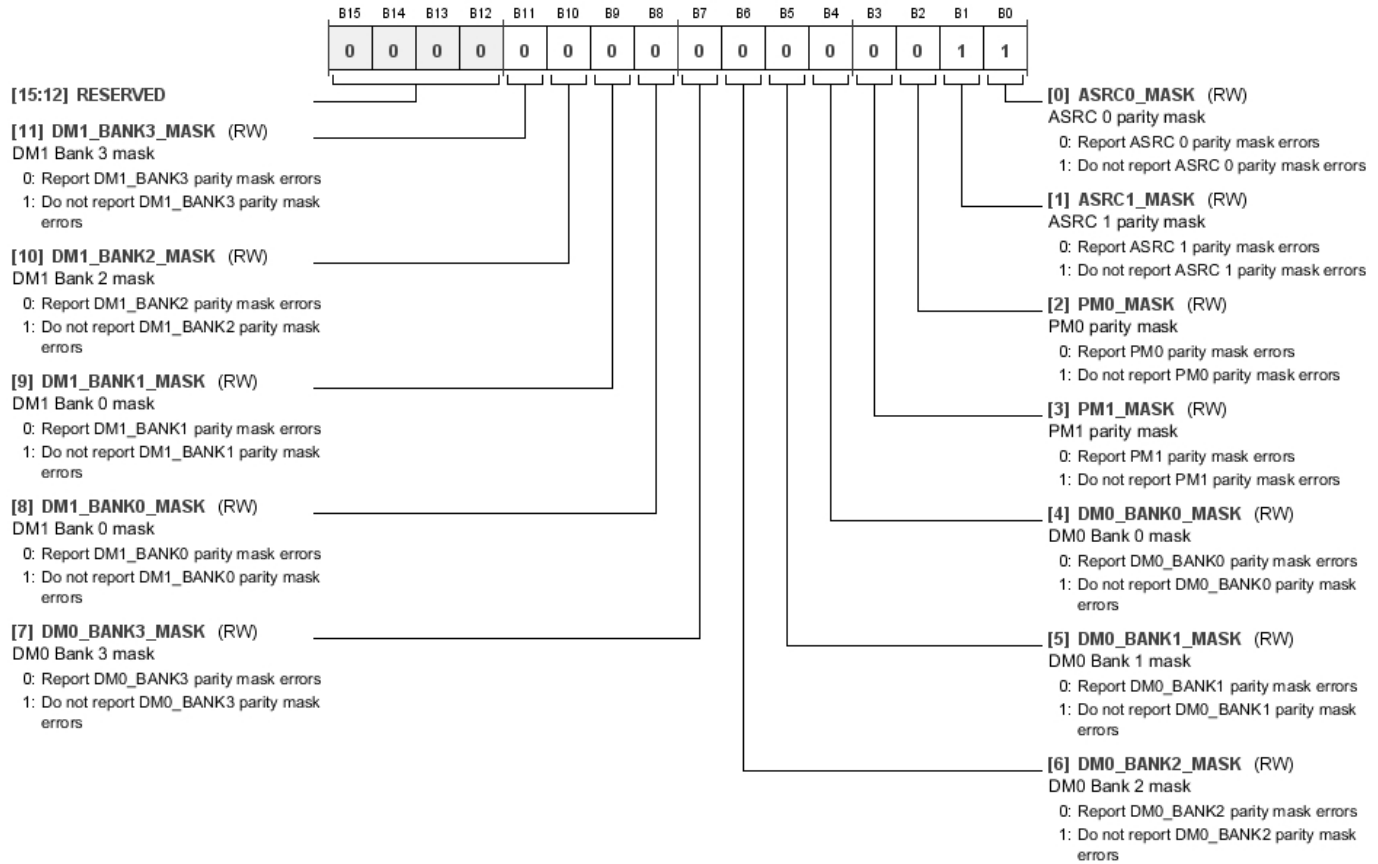

**Table 97. Bit Descriptions for PANIC\_PARITY\_MASK**

Bits	Bit Name	Settings	Description	Reset	Access
[15:12]	RESERVED			0x0	RW
11	DM1_BANK3_MASK	0 1	DM1 Bank 3 mask. Report DM1_BANK3 parity mask errors Do not report DM1_BANK3 parity mask errors	0x0	RW
10	DM1_BANK2_MASK	0 1	DM1 Bank 2 mask. Report DM1_BANK2 parity mask errors Do not report DM1_BANK2 parity mask errors	0x0	RW
9	DM1_BANK1_MASK	0 1	DM1 Bank 1 mask. Report DM1_BANK1 parity mask errors Do not report DM1_BANK1 parity mask errors	0x0	RW
8	DM1_BANK0_MASK	0 1	DM1 Bank 0 mask. Report DM1_BANK0 parity mask errors Do not report DM1_BANK0 parity mask errors	0x0	RW
7	DM0_BANK3_MASK	0 1	DM0 Bank 3 mask. Report DM0_BANK3 parity mask errors Do not report DM0_BANK3 parity mask errors	0x0	RW



Bits	Bit Name	Settings	Description	Reset	Access
6	DM0_BANK2_MASK	0 1	DM0 Bank 2 mask. 0 Report DM0_BANK2 parity mask errors 1 Do not report DM0_BANK2 parity mask errors	0x0	RW
5	DM0_BANK1_MASK	0 1	DM0 Bank 1 mask. 0 Report DM0_BANK1 parity mask errors 1 Do not report DM0_BANK1 parity mask errors	0x0	RW
4	DM0_BANK0_MASK	0 1	DM0 Bank 0 mask. 0 Report DM0_BANK0 parity mask errors 1 Do not report DM0_BANK0 parity mask errors	0x0	RW
3	PM1_MASK	0 1	PM1 parity mask. 0 Report PM1 parity mask errors 1 Do not report PM1 parity mask errors	0x0	RW
2	PM0_MASK	0 1	PM0 parity mask. 0 Report PM0 parity mask errors 1 Do not report PM0 parity mask errors	0x0	RW
1	ASRC1_MASK	0 1	ASRC 1 parity mask. 0 Report ASRC 1 parity mask errors 1 Do not report ASRC 1 parity mask errors	0x1	RW
0	ASRC0_MASK	0 1	ASRC 0 parity mask. 0 Report ASRC 0 parity mask errors 1 Do not report ASRC 0 parity mask errors	0x1	RW

**Panic Mask 0 Register**

Address: 0xF423, Reset: 0x0000, Name: PANIC\_SOFTWARE\_MASK

The panic manager checks and reports software errors. Register 0xF423 (PANIC\_SOFTWARE\_MASK) allows the user to configure whether software errors are reported to the panic manager or ignored.

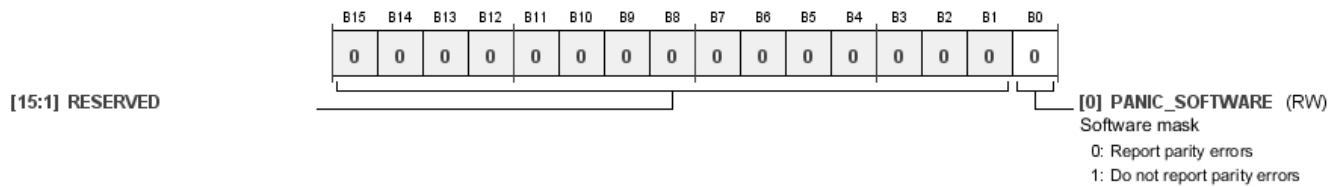

Table 98. Bit Descriptions for PANIC\_SOFTWARE\_MASK

Bits	Bit Name	Settings	Description	Reset	Access
[15:1]	RESERVED			0x0	RW
0	PANIC_SOFTWARE	0 1	Software mask. 0 Report parity errors 1 Do not report parity errors	0x0	RW

**Panic Mask 1 Register**

Address: 0xF424, Reset: 0x0000, Name: PANIC\_WD\_MASK

The panic manager checks and reports watchdog errors. Register 0xF424 (PANIC\_WD\_MASK) allows the user to configure whether watchdog errors are reported to the panic manager or ignored.

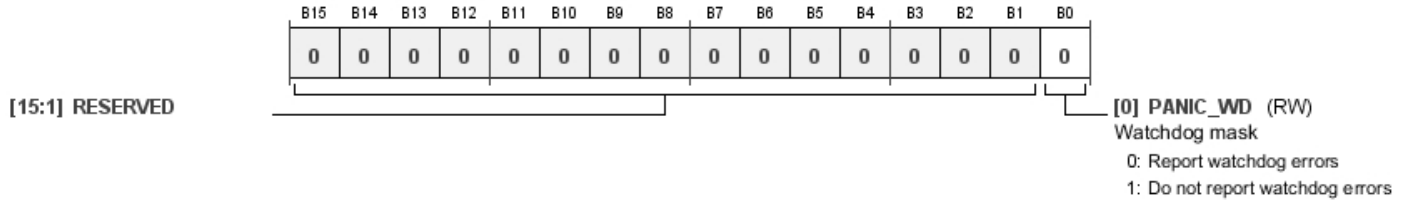

**Table 99. Bit Descriptions for PANIC\_WD\_MASK**

Bits	Bit Name	Settings	Description	Reset	Access
[15:1]	RESERVED			0x0	RW
0	PANIC_WD	0 1	Watchdog mask. 0 Report watchdog errors 1 Do not report watchdog errors	0x0	RW

**Panic Mask 2 Register**

Address: 0xF425, Reset: 0x0000, Name: PANIC\_STACK\_MASK

The panic manager checks and reports stack errors. Register 0xF425 (PANIC\_STACK\_MASK) allows the user to configure whether stack errors are reported to the panic manager or ignored.

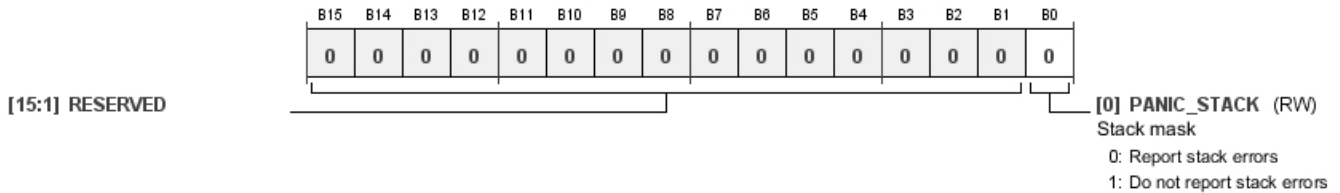

**Table 100. Bit Descriptions for PANIC\_STACK\_MASK**

Bits	Bit Name	Settings	Description	Reset	Access
[15:1]	RESERVED			0x0	RW
0	PANIC_STACK	0 1	Stack mask. 0 Report stack errors 1 Do not report stack errors	0x0	RW

**Panic Mask 3 Register**

Address: 0xF426, Reset: 0x0000, Name: PANIC\_LOOP\_MASK

The panic manager checks and reports software errors related to looping code sections. Register 0xF426 (PANIC\_LOOP\_MASK) allows the user to configure whether loop errors are reported to the panic manager or ignored.

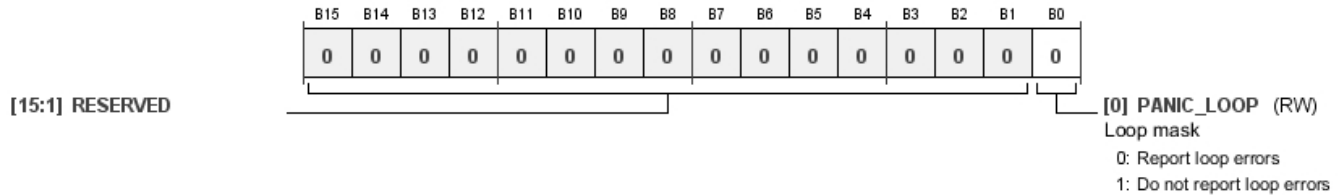

Table 101. Bit Descriptions for PANIC\_LOOP\_MASK

Bits	Bit Name	Settings	Description	Reset	Access
[15:1]	RESERVED			0x0	RW
0	PANIC_LOOP	0 1	Loop mask. 0 Report loop errors 1 Do not report loop errors	0x0	RW

**Panic Flag Register**

Address: 0xF427, Reset: 0x0000, Name: PANIC\_FLAG

This register acts as the master error flag for the panic manager. If any error is encountered in any functional block whose panic manager mask is disabled, this register logs that an error has occurred. Individual functional block masks are configured using Register 0xF422 (PANIC\_PARITY\_MASK), Register 0xF423 (PANIC\_SOFTWARE\_MASK), Register 0xF424 (PANIC\_WD\_MASK), Register 0xF425 (PANIC\_STACK\_MASK), and Register 0xF426 (PANIC\_LOOP\_MASK).

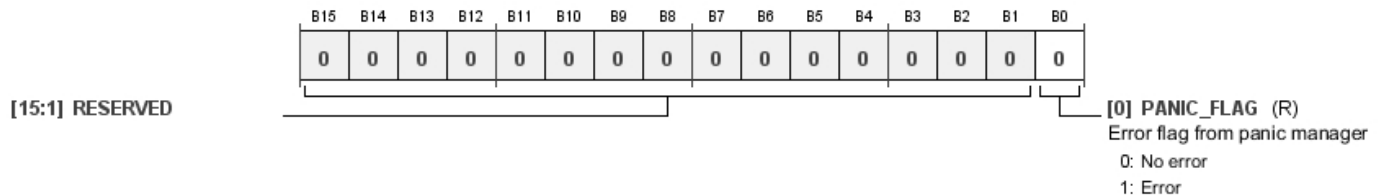

Table 102. Bit Descriptions for PANIC\_FLAG

Bits	Bit Name	Settings	Description	Reset	Access
[15:1]	RESERVED			0x0	RW
0	PANIC_FLAG	0 1	Error flag from panic manager. This error flag bit is sticky. When an error is reported, this bit goes high, and it stays high until the user resets it using Register 0xF421 (PANIC_CLEAR). 0 No error 1 Error	0x0	R

**Panic Code Register**

Address: 0xF428, Reset: 0x0000, Name: PANIC\_CODE

When Register 0xF427 (PANIC\_FLAG) indicates that an error has occurred, this register provides details revealing which subsystem is reporting an error. If several errors occur, this register reports only the first error that occurs. Subsequent errors are ignored until the register is cleared by toggling Register 0xF421 (PANIC\_CLEAR).

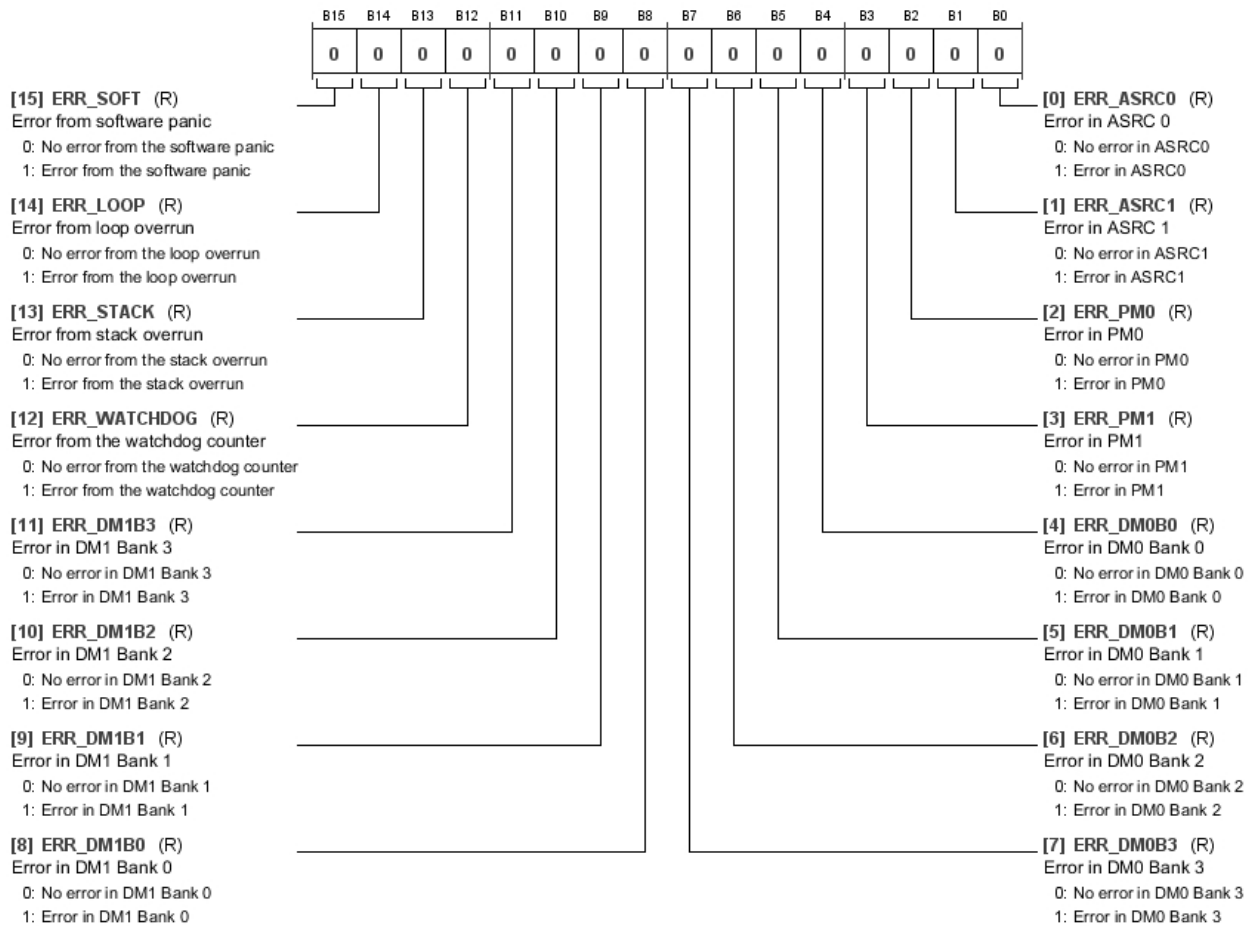

**Table 103. Bit Descriptions for PANIC\_CODE**

Bits	Bit Name	Settings	Description	Reset	Access
15	ERR_SOFT	0 1	Error from software panic. No error from the software panic Error from the software panic	0x0	R
14	ERR_LOOP	0 1	Error from loop overrun. No error from the loop overrun Error from the loop overrun	0x0	R
13	ERR_STACK	0 1	Error from stack overrun. No error from the stack overrun Error from the stack overrun	0x0	R
12	ERR_WATCHDOG	0 1	Error from the watchdog counter. No error from the watchdog counter Error from the watchdog counter	0x0	R
11	ERR_DM1B3	0 1	Error in DM1 Bank 3. No error in DM1 Bank 3 Error in DM1 Bank 3	0x0	R

Bits	Bit Name	Settings	Description	Reset	Access
10	ERR_DM1B2	0 1	Error in DM1 Bank 2. No error in DM1 Bank 2 Error in DM1 Bank 2	0x0	R
9	ERR_DM1B1	0 1	Error in DM1 Bank 1. No error in DM1 Bank 1 Error in DM1 Bank 1	0x0	R
8	ERR_DM1B0	0 1	Error in DM1 Bank 0. No error in DM1 Bank 0 Error in DM1 Bank 0	0x0	R
7	ERR_DM0B3	0 1	Error in DM0 Bank 3. No error in DM0 Bank 3 Error in DM0 Bank 3	0x0	R
6	ERR_DM0B2	0 1	Error in DM0 Bank 2. No error in DM0 Bank 2 Error in DM0 Bank 2	0x0	R
5	ERR_DM0B1	0 1	Error in DM0 Bank 1. No error in DM0 Bank 1 Error in DM0 Bank 1	0x0	R
4	ERR_DM0B0	0 1	Error in DM0 Bank 0. No error in DM0 Bank 0 Error in DM0 Bank 0	0x0	R
3	ERR_PM1	0 1	Error in PM1. No error in PM1 Error in PM1	0x0	R
2	ERR_PM0	0 1	Error in PM0. No error in PM0 Error in PM0	0x0	R
1	ERR_ASRC1	0 1	Error in ASRC 1. No error in ASRC 1 Error in ASRC 1	0x0	R
0	ERR_ASRC0	0 1	Error in ASRC 0. No error in ASRC 0 Error in ASRC 0	0x0	R

**Execute Stage Error Program Count Register**

Address: 0xF432, Reset: 0x0000, Name: EXECUTE\_COUNT

When a software error occurs, this register logs the program instruction count at the time when the error occurred for software debugging purposes.

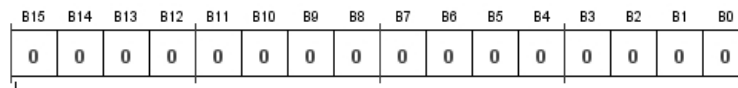

[15:0] EXECUTE\_COUNT (RW)  
Program count in the execute stage when the error occurred

**Table 104. Bit Descriptions for EXECUTE\_COUNT**

Bits	Bit Name	Settings	Description	Reset	Access
[15:0]	EXECUTE_COUNT		Program count in the execute stage when the error occurred.	0x0000	RW

**Watchdog Maximum Count Register**

Address: 0xF443, Reset: 0x0000, Name: WATCHDOG\_MAXCOUNT

This register is designed to start counting at a specified number and decrement by 1 for each clock cycle of the system clock in the core. The counter is reset to the maximum value each time the program counter jumps to the beginning of the program to begin processing another audio frame (this is implemented in the DSP program code generated by SigmaStudio). If the counter reaches 0, a watchdog error flag is raised in the panic manager. The watchdog is typically set to begin counting from a number slightly larger than the maximum number of instructions expected to execute in the program, such that an error occurs if the program does not finish in time for the next incoming sample.

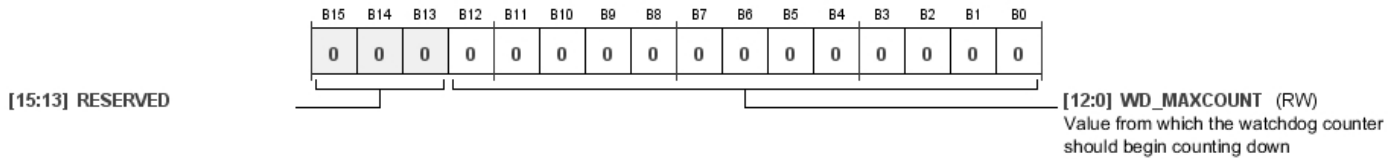

Table 105. Bit Descriptions for WATCHDOG\_MAXCOUNT

Bits	Bit Name	Settings	Description	Reset	Access
[15:13]	RESERVED			0x0	RW
[12:0]	WD_MAXCOUNT		Value from which the watchdog counter should begin counting down.	0x0000	RW

**Watchdog Prescale Register**

Address: 0xF444, Reset: 0x0000, Name: WATCHDOG\_PRESCALE

The watchdog prescaler is a number that is multiplied by the setting in Register 0xF443 (WATCHDOG\_MAXCOUNT) to achieve very large counts for the watchdog, if necessary. Using the largest prescale factor of 128 × 1024 and the largest watchdog maximum count of 64 × 1024, a very large watchdog counter, on the order of 8.5 billion clock cycles, can be achieved.

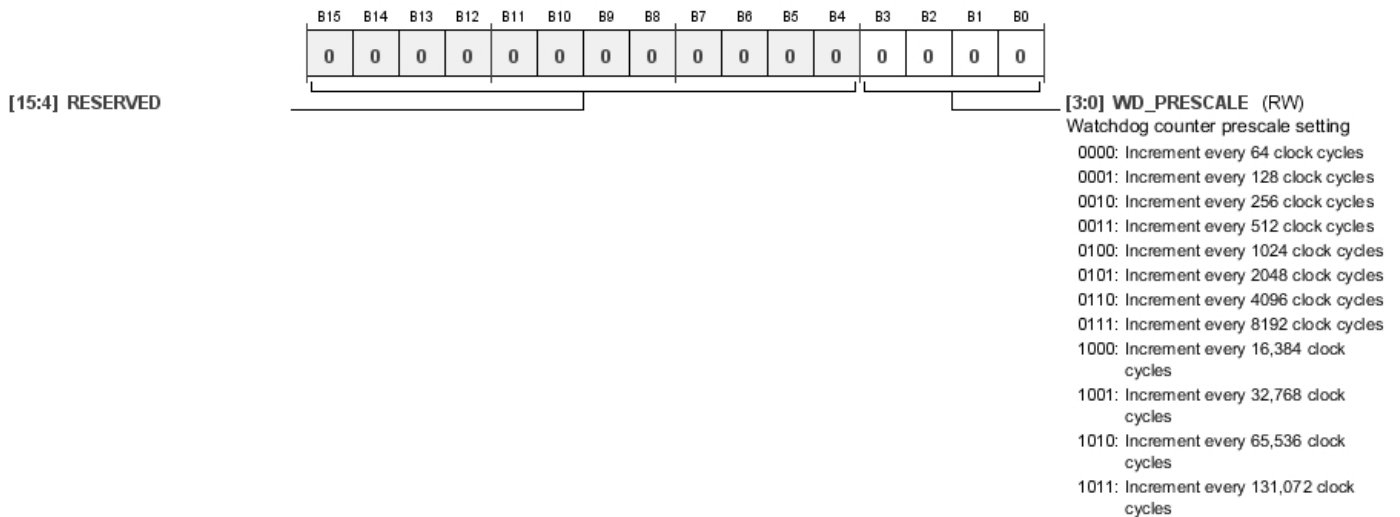

Table 106. Bit Descriptions for WATCHDOG\_PRESCALE

Bits	Bit Name	Settings	Description	Reset	Access
[15:4]	RESERVED			0x0	RW
[3:0]	WD_PRESCALE	0000 Increment every 64 clock cycles 0001 Increment every 128 clock cycles 0010 Increment every 256 clock cycles 0011 Increment every 512 clock cycles 0100 Increment every 1024 clock cycles 0101 Increment every 2048 clock cycles 0110 Increment every 4096 clock cycles 0111 Increment every 8192 clock cycles 1000 Increment every 16,384 clock cycles 1001 Increment every 32,768 clock cycles 1010 Increment every 65,536 clock cycles 1011 Increment every 131,072 clock cycles	Watchdog counter prescale setting.	0x0	RW

**DSP PROGRAM EXECUTION REGISTERS**

**Enable Block Interrupts Register**

Address: 0xF450, Reset: 0x0000, Name: BLOCKINT\_EN

This register enables block interrupts, which are necessary when frequency domain processing is required in the audio processing program. If block processing algorithms are used in SigmaStudio, SigmaStudio automatically sets this register accordingly. The user does not need to manually change the value of this register after SigmaStudio has configured it.

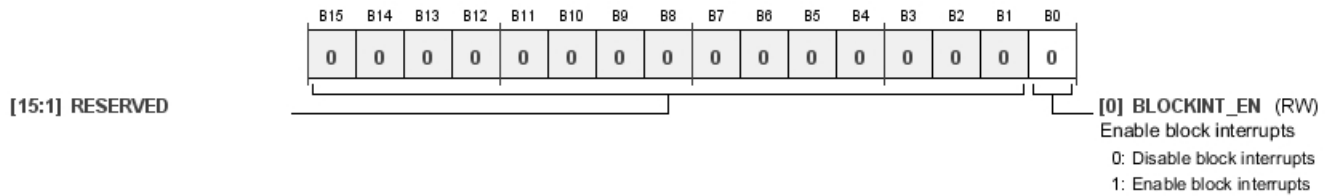

Table 107. Bit Descriptions for BLOCKINT\_EN

Bits	Bit Name	Settings	Description	Reset	Access
[15:1]	RESERVED			0x0	RW
0	BLOCKINT_EN	0 Disable block interrupts 1 Enable block interrupts	Enable block interrupts.	0x0	RW

**Value for the Block Interrupt Counter Register**

Address: 0xF451, Reset: 0x0000, Name: BLOCKINT\_VALUE

This 16-bit register controls the duration in audio frames of a block. A counter increments each time a new frame start pulse is received by the DSP core. When the counter reaches the value determined by this register, a block interrupt is generated and the counter is reset. If block processing algorithms are used in SigmaStudio, SigmaStudio automatically sets this register accordingly. The user does not need to manually change the value of this register after SigmaStudio has configured it.

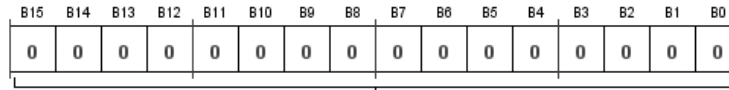

[15:0] BLOCKINT\_VALUE (RW)  
Value for the block interrupt counter

Table 108. Bit Descriptions for BLOCKINT\_VALUE

Bits	Bit Name	Settings	Description	Reset	Access
[15:0]	BLOCKINT_VALUE		Value for the block interrupt counter.	0x0000	RW

**Program Counter, Bits[23:16] Register**

Address: 0xF460, Reset: 0x0000, Name: PROG\_CNTR0

This register, in combination with Register 0xF461 (PROG\_CNTR1), stores the current value of the program counter.

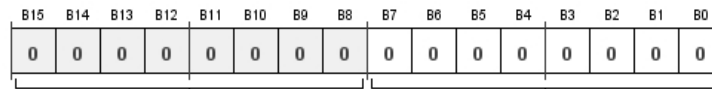

[15:8] RESERVED

[7:0] PROG\_CNTR\_MSB (R)  
Program counter, Bits [23:16]

Table 109. Bit Descriptions for PROG\_CNTR0

Bits	Bit Name	Settings	Description	Reset	Access
[15:8]	RESERVED			0x0	RW
[7:0]	PROG_CNTR_MSB		Program counter, Bits[23:16].	0x00	R

**Program Counter, Bits[15:0] Register**

Address: 0xF461, Reset: 0x0000, Name: PROG\_CNTR1

This register, in combination with Register 0xF460 (PROG\_CNTR0), stores the current value of the program counter.

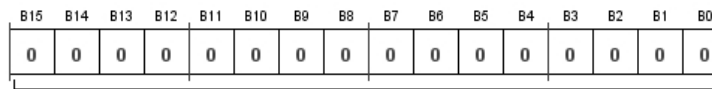

[15:0] PROG\_CNTR\_LSB (R)  
Program counter, Bits [15:0]

Table 110. Bit Descriptions for PROG\_CNTR1

Bits	Bit Name	Settings	Description	Reset	Access
[15:0]	PROG_CNTR_LSB		Program counter, Bits[15:0].	0x0000	R



**Program Counter Clear Register**

Address: 0xF462, Reset: 0x0000, Name: PROG\_CNTR\_CLEAR

Enabling and disabling Bit 0 (PROG\_CNTR\_CLEAR) resets Register 0xF465 (PROG\_CNTR\_MAXLENGTH0) and Register 0xF466 (PROG\_CNTR\_MAXLENGTH1).

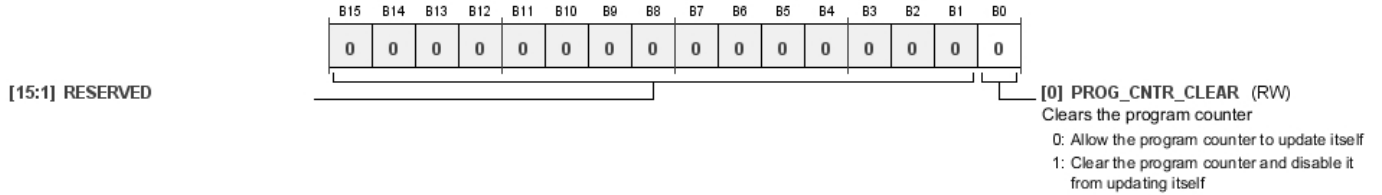

Table 111. Bit Descriptions for PROG\_CNTR\_CLEAR

Bits	Bit Name	Settings	Description	Reset	Access
[15:1]	RESERVED			0x0	RW
0	PROG_CNTR_CLEAR	0 1	Clears the program counter. Allow the program counter to update itself Clear the program counter and disable it from updating itself	0x0	RW

**Program Counter Length, Bits[23:16] Register**

Address: 0xF463, Reset: 0x0000, Name: PROG\_CNTR\_LENGTH0

This register, in combination with Register 0xF464 (PROG\_CNTR\_LENGTH1), keeps track of the peak value reached by the program counter during the last audio frame or block. It can be cleared using Register 0xF462 (PROG\_CNTR\_CLEAR).

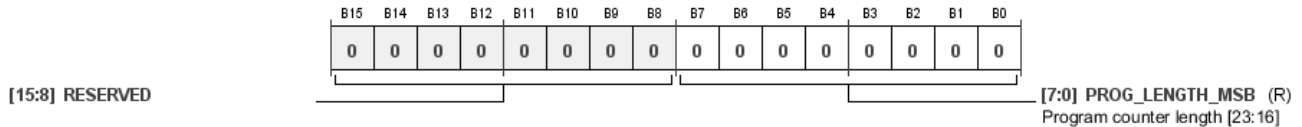

Table 112. Bit Descriptions for PROG\_CNTR\_LENGTH0

Bits	Bit Name	Settings	Description	Reset	Access
[15:8]	RESERVED			0x0	RW
[7:0]	PROG_LENGTH_MSB		Program counter length, Bits[23:16].	0x00	R

**Program Counter Length, Bits[15:0] Register**

Address: 0xF464, Reset: 0x0000, Name: PROG\_CNTR\_LENGTH1

This register, in combination with Register 0xF463 (PROG\_CNTR\_LENGTH0), keeps track of the peak value reached by the program counter during the last audio frame or block. It can be cleared using Register 0xF462 (PROG\_CNTR\_CLEAR).

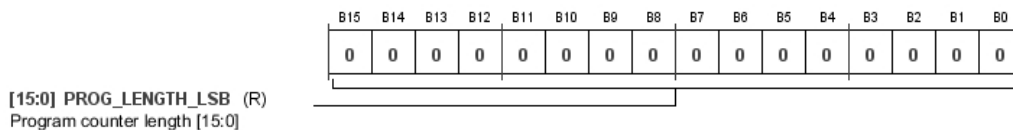

Table 113. Bit Descriptions for PROG\_CNTR\_LENGTH1

Bits	Bit Name	Settings	Description	Reset	Access
[15:0]	PROG_LENGTH_LSB		Program counter length, Bits[15:0].	0x0000	R

**Program Counter Max Length, Bits[23:16] Register**

Address: 0xF465, Reset: 0x0000, Name: PROG\_CNTR\_MAXLENGTH0

This register, in combination with Register 0xF466 (PROG\_CNTR\_MAXLENGTH1), keeps track of the highest peak value reached by the program counter since the DSP core started. It can be cleared using Register 0xF462 (PROG\_CNTR\_CLEAR).

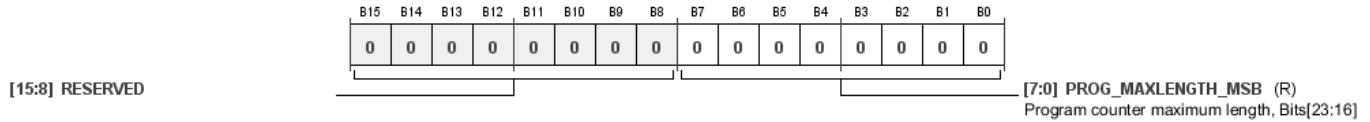

**Table 114. Bit Descriptions for PROG\_CNTR\_MAXLENGTH0**

Bits	Bit Name	Settings	Description	Reset	Access
[15:8]	RESERVED			0x0	RW
[7:0]	PROG_MAXLENGTH_MSB		Program counter maximum length, Bits[23:16].	0x00	R

**Program Counter Max Length, Bits[15:0] Register**

Address: 0xF466, Reset: 0x0000, Name: PROG\_CNTR\_MAXLENGTH1

This register, in combination with Register 0xF465 (PROG\_CNTR\_MAXLENGTH0), keeps track of the highest peak value reached by the program counter since the DSP core started. It can be cleared using Register 0xF462 (PROG\_CNTR\_CLEAR).

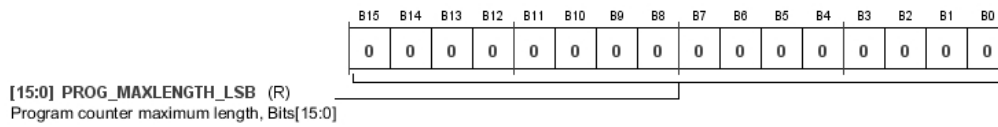

**Table 115. Bit Descriptions for PROG\_CNTR\_MAXLENGTH1**

Bits	Bit Name	Settings	Description	Reset	Access
[15:0]	PROG_MAXLENGTH_LSB		Program counter maximum length, Bits[15:0].	0x0000	R

**MULTIPURPOSE PIN CONFIGURATION REGISTERS**

**Multipurpose Pin Mode Register**

Address: 0xF510 to 0xF51D (Increments of 0x1), Reset: 0x0000, Name: MPx\_MODE

These 14 registers configure the multipurpose pins. Certain multipurpose pins can function as audio clock pins, control bus pins, or general-purpose input or output (GPIO) pins.

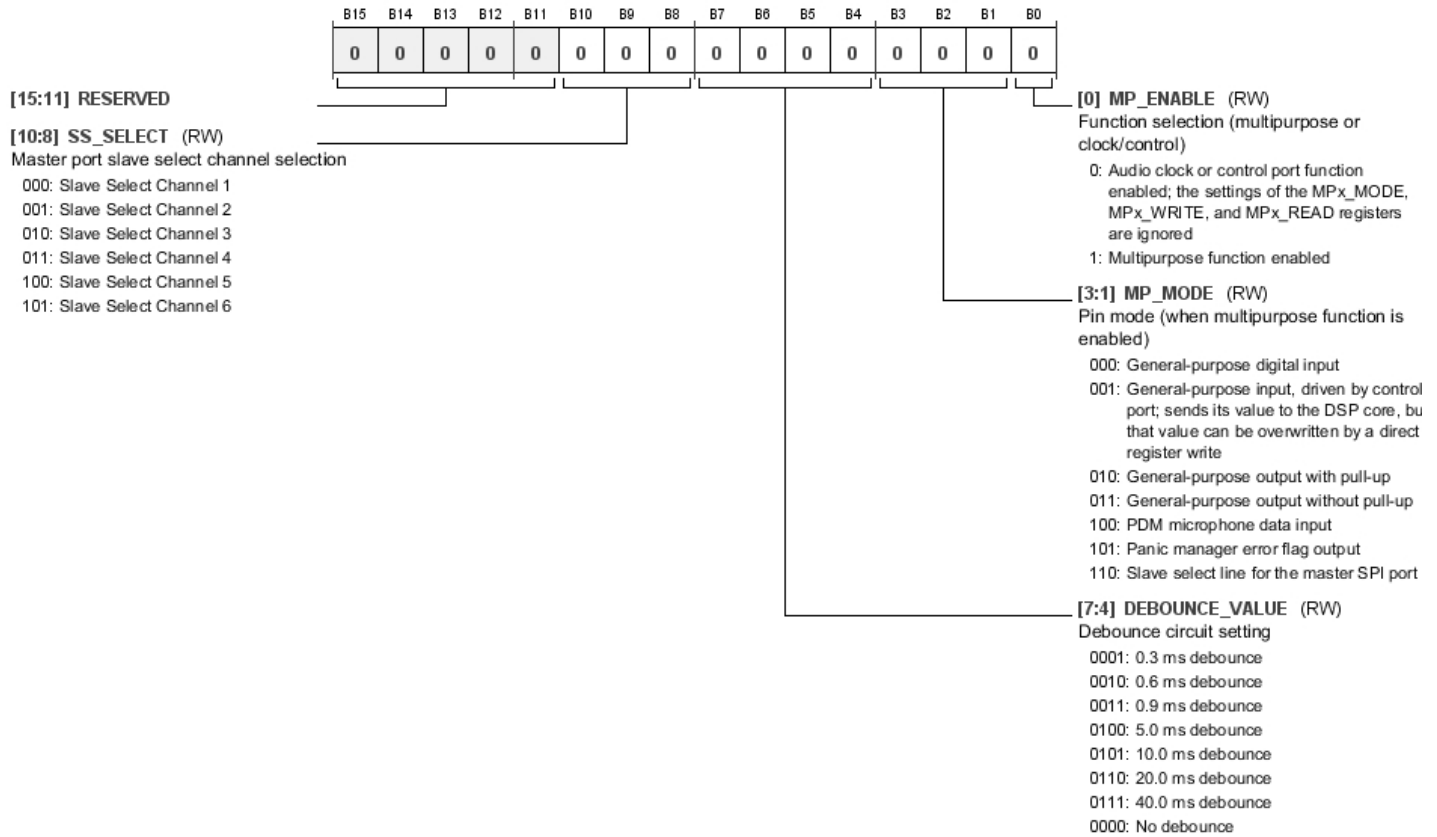

**Table 116. Bit Descriptions for MPx\_MODE**

Bits	Bit Name	Settings	Description	Reset	Access
[15:11]	RESERVED			0x0	RW
[10:8]	SS_SELECT		Master port slave select channel selection. If the pin is configured as a slave select line (Bits[3:1] (MP_MODE) = 0b110), these bits configure which slave select channel the pin corresponds to. This allows multiple slave devices to be connected to the SPI master port, all using different slave select lines. The first slave select signal (Slave Select 0) is always routed to the SS_M/MP0 pin. The remaining six slave select lines can be routed to any multipurpose pin that has been configured as a slave select output.	0x0	RW
		000	Slave Select Channel 1		
		001	Slave Select Channel 2		
		010	Slave Select Channel 3		
		011	Slave Select Channel 4		
		100	Slave Select Channel 5		
		101	Slave Select Channel 6		

Bits	Bit Name	Settings	Description	Reset	Access
[7:4]	DEBOUNCE_VALUE	0001 0.3 ms debounce 0010 0.6 ms debounce 0011 0.9 ms debounce 0100 5.0 ms debounce 0101 10.0 ms debounce 0110 20.0 ms debounce 0111 40.0 ms debounce 0000 No debounce	Debounce circuit setting. These bits configure the duration of the debounce circuitry when the corresponding pin is configured as an input (Bits[3:1] (MP_MODE) = 0b000).	0x0	RW
[3:1]	MP_MODE	000 General-purpose digital input 001 General-purpose input, driven by control port; sends its value to the DSP core, but that value can be overwritten by a direct register write 010 General-purpose output with pull-up 011 General-purpose output without pull-up 100 PDM microphone data input 101 Panic manager error flag output 110 Slave select line for the master SPI port	Pin mode (when multipurpose function is enabled). These bits select the function of the corresponding pin if it is enabled in multipurpose mode (Bit 0 (MP_ENABLE) = 0b1).	0x0	RW
0	MP_ENABLE	0 Audio clock or control port function enabled; the settings of the MPx_MODE, MPx_WRITE, and MPx_READ registers are ignored 1 Multipurpose function enabled	Function selection (multipurpose or clock/control). This bit selects whether the corresponding pin is used as a multipurpose pin or as its primary function (which could be either an audio clock or control bus pin).	0x0	RW

**Multipurpose Pin Write Value Register**

Address: 0xF520 to 0xF52D (Increments of 0x1), Reset: 0x0000, Name: MPx\_WRITE

If a multipurpose pin is configured as an output driven by the control port (the corresponding Bits[3:1] (MP\_MODE) = 0b001), the value that is output from the DSP core can be configured by directly writing to these registers.

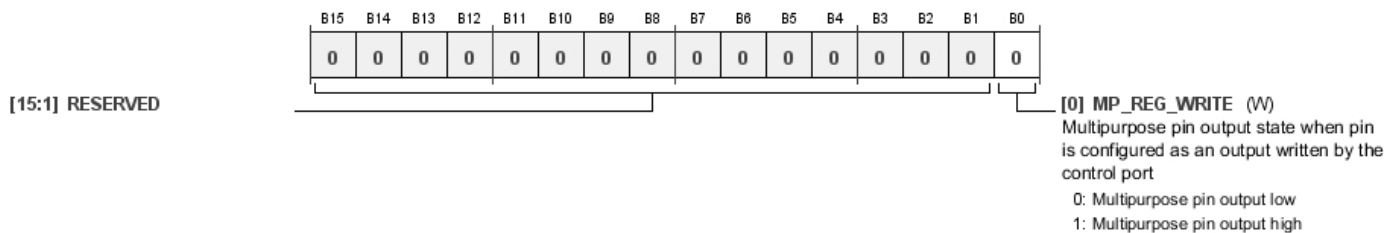

Table 117. Bit Descriptions for MPx\_WRITE

Bits	Bit Name	Settings	Description	Reset	Access
[15:1]	RESERVED			0x0	W
0	MP_REG_WRITE	0 Multipurpose pin output low 1 Multipurpose pin output high	Multipurpose pin output state when pin is configured as an output written by the control port. This register configures the value seen by the DSP core for the corresponding multipurpose pin input. The pin can have two states: logic low (off) or logic high (on).	0x0	W

**Multipurpose Pin Read Value Registers**

Address: 0xF530 to 0xF53D (Increments of 0x1), Reset: 0x0000, Name: MPx\_READ

These registers log the current state of the multipurpose pins when they are configured as inputs. The pins can have two states: logic low (off) or logic high (on).

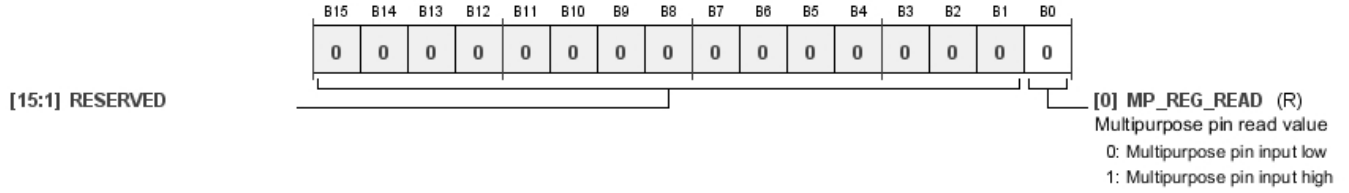

**Table 118. Bit Descriptions for MPx\_READ**

Bits	Bit Name	Settings	Description	Reset	Access
[15:1]	RESERVED			0x0	R
0	MP_REG_READ	0 1	Multipurpose pin read value. Multipurpose pin input low Multipurpose pin input high	0x0	R

**Digital PDM Microphone Control Register**

Address: 0xF560 to 0xF561 (Increments of 0x1), Reset: 0x4000, Name: DMIC\_CTRLx

These registers configure the digital PDM microphone interface. Two registers are used to control up to four PDM microphones: Register 0xF560 (DMIC\_CTRL0) configures PDM Microphone Channel 0 and PDM Microphone Channel 1, and Register 0xF561 (DMIC\_CTRL1) configures PDM Microphone Channel 2 and PDM Microphone Channel 3.

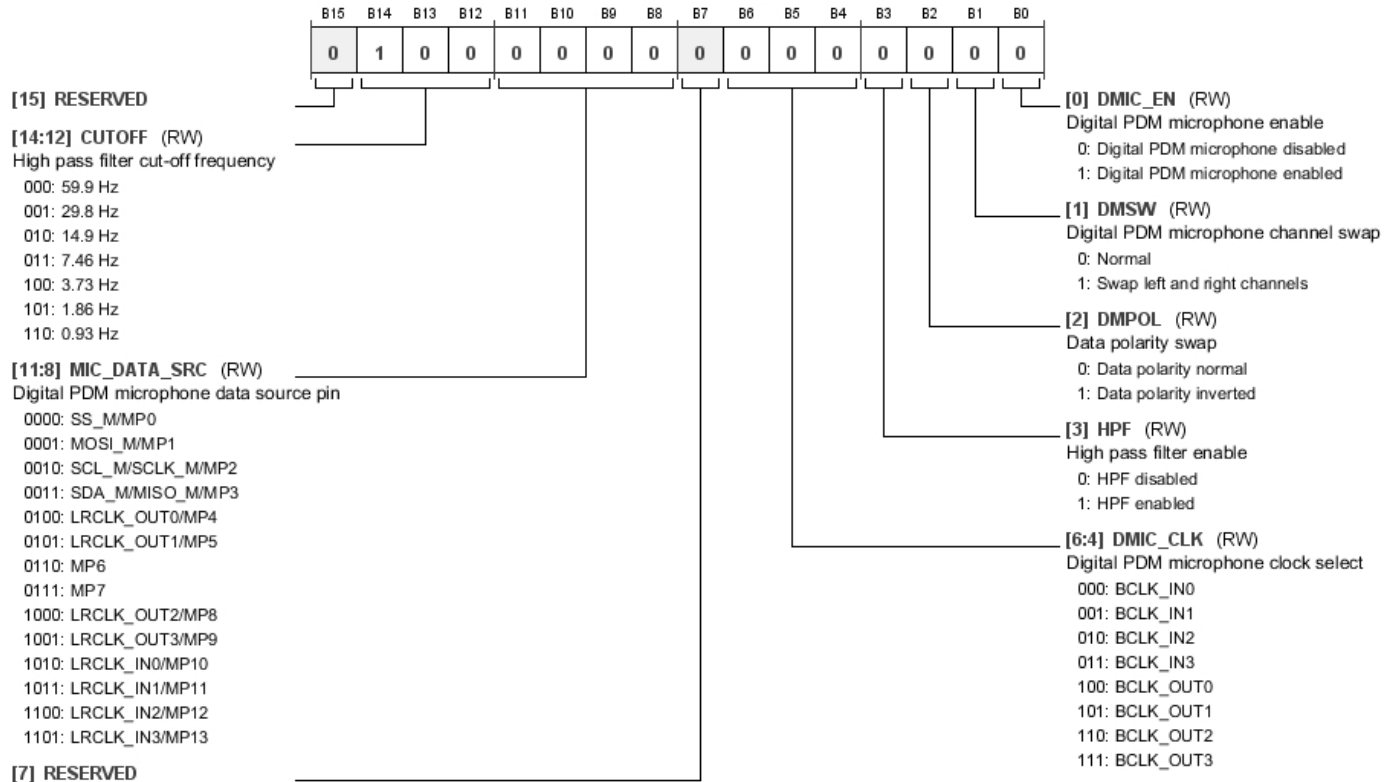

**Table 119. Bit Descriptions for DMIC\_CTRLx**

Bits	Bit Name	Settings	Description	Reset	Access
15	RESERVED			0x0	RW
[14:12]	CUTOFF	000 001 010 011 100 101 110	High-pass filter cutoff frequency. These bits configure the cutoff frequency of an optional high-pass filter designed to remove dc components from the microphone data signal(s). To use these bits, Bit 3 (HPF), must be enabled. 59.9 Hz 29.8 Hz 14.9 Hz 7.46 Hz 3.73 Hz 1.86 Hz 0.93 Hz	0x4	RW

Bits	Bit Name	Settings	Description	Reset	Access
[11:8]	MIC_DATA_SRC	0000 SS_M/MP0 0001 MOSI_M/MP1 0010 SCL_M/SCLK_M/MP2 0011 SDA_M/MISO_M/MP3 0100 LRCLK_OUT0/MP4 0101 LRCLK_OUT1/MP5 0110 MP6 0111 MP7 1000 LRCLK_OUT2/MP8 1001 LRCLK_OUT3/MP9 1010 LRCLK_IN0/MP10 1011 LRCLK_IN1/MP11 1100 LRCLK_IN2/MP12 1101 LRCLK_IN3/MP13	Digital PDM microphone data source pin. These bits configure which hardware pin acts as a data input from the PDM microphone(s). Up to two microphones can be connected to a single pin.	0x0	RW
7	RESERVED			0x0	RW
[6:4]	DMIC_CLK	000 BCLK_IN0 001 BCLK_IN1 010 BCLK_IN2 011 BCLK_IN3 100 BCLK_OUT0 101 BCLK_OUT1 110 BCLK_OUT2 111 BCLK_OUT3	Digital PDM microphone clock select. A valid bit clock signal must be assigned to the PDM microphones. Any of the four BCLK_INPUTx or four BCLK_OUTPUTx signals can be used. A trace must connect the selected pin to the clock input pin on the corresponding PDM microphone(s). If the corresponding BCLK_x pin is not configured in master mode, use an external clock source, with the BCLK_x pin and the PDM microphone acting as slaves.	0x0	RW
3	HPF	0 HPF disabled 1 HPF enabled	High-pass filter enable. This bit enables or disables a high-pass filter to remove dc components from the microphone data signals. The cutoff of the filter is controlled by Bits[14:12] (CUTOFF).	0x0	RW
2	DMPOL	0 Data polarity normal 1 Data polarity inverted	Data polarity swap. When this bit is set to 0b0, a logic high data input is treated as logic high, and a logic low data input is treated as logic low. When this bit is set to 0b1, the opposite is true: a logic high data input is treated as a logic low, and a logic low data input is treated as logic high. This effectively inverts the amplitude of the incoming audio data.	0x0	RW
1	DMSW	0 Normal 1 Swap left and right channels	Digital PDM microphone channel swap. In DMIC_CTRL0, this bit swaps PDM Microphone Channel 0 and PDM Microphone Channel 1. In the DMIC_CTRL1 register, this bit swaps PDM Microphone Channel 2 and PDM Microphone Channel 3.	0x0	RW
0	DMIC_EN	0 Digital PDM microphone disabled 1 Digital PDM microphone enabled	Digital PDM microphone enable. This bit enables or disables the data input from the PDM microphones.	0x0	RW

**ASRC STATUS AND CONTROL REGISTERS**

**ASRC Lock Status Register**

Address: 0xF580, Reset: 0x0000, Name: ASRC\_LOCK

This register contains eight bits that represent the lock status of each ASRC stereo pair on the ADAU1452 and ADAU1451. Lock status requires three conditions: the output target rate is set, the input rate is steady and has been detected, and the ratio between input and output rates has been calculated. If all of these conditions are true for a given stereo ASRC, the corresponding lock bit is low. If any of these conditions is not true, the corresponding lock bit is high.

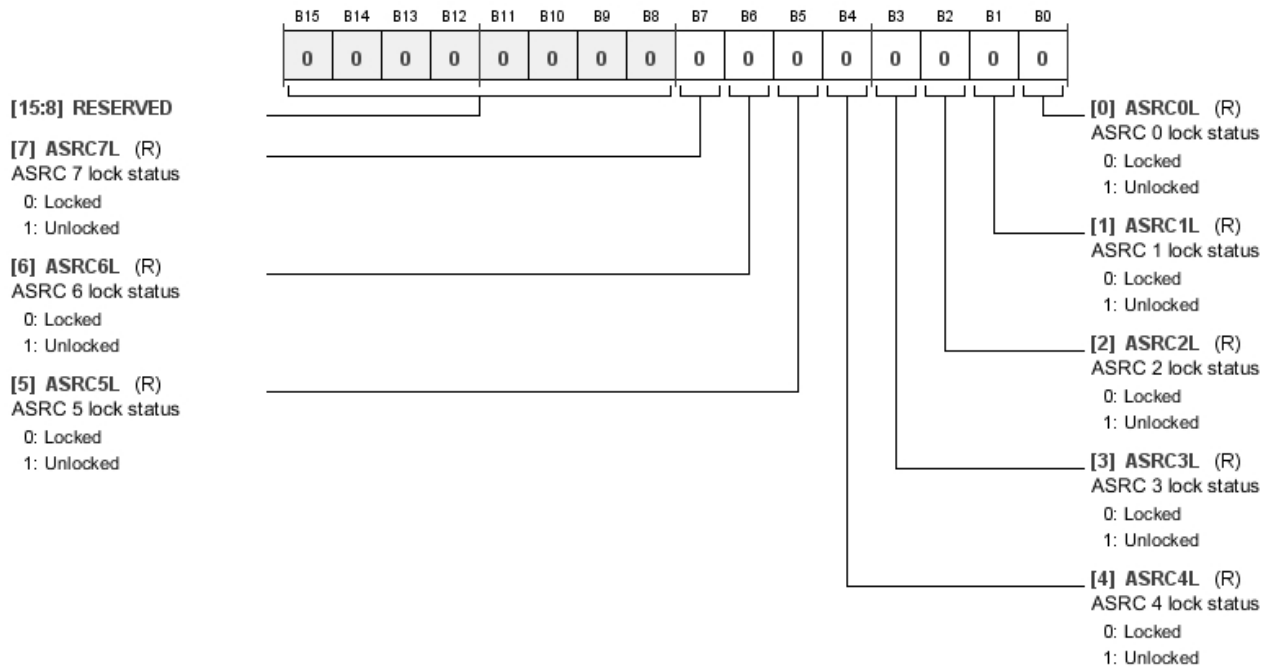

Table 120. Bit Descriptions for ASRC\_LOCK

Bits	Bit Name	Settings	Description	Reset	Access
[15:8]	RESERVED			0x0	RW
7	ASRC7L	0 1	ASRC 7 lock status. Locked Unlocked	0x0	R
6	ASRC6L	0 1	ASRC 6 lock status. Locked Unlocked	0x0	R
5	ASRC5L	0 1	ASRC 5 lock status. Locked Unlocked	0x0	R
4	ASRC4L	0 1	ASRC 4 lock status. Locked Unlocked	0x0	R
3	ASRC3L	0 1	ASRC 3 lock status. Locked Unlocked	0x0	R
2	ASRC2L	0 1	ASRC 2 lock status. Locked Unlocked	0x0	R



Bits	Bit Name	Settings	Description	Reset	Access
1	ASRC1L	0 1	ASRC 1 lock status. Locked Unlocked	0x0	R
0	ASRC0L	0 1	ASRC 0 lock status. Locked Unlocked	0x0	R

**ASRC Mute Register**

Address: 0xF581, Reset: 0x0000, Name: ASRC\_MUTE

This register contains controls related to the muting of audio on ASRC channels. Bits[7:0] (ASRCxM) are individual mute controls for each stereo ASRC on the ADAU1452 and ADAU1451. Bit 8 (ASRC\_RAMP0) and Bit 9 (ASRC\_RAMP1) enable or disable an optional volume ramp-up and ramp-down to smoothly transition between muted and unmuted states. The mute and unmute ramps are linear. The duration of the ramp is determined by the sample rate of the DSP core, which is set by Register 0xF401 (START\_PULSE). The ramp takes exactly 2048 input samples to complete. For example, if the sample rate of audio entering an ASRC channel is 48 kHz, the duration of the ramp is 2048/48,000 = 42.7 ms. If the sample rate of audio entering an ASRC channel is 6 kHz, the duration of the ramp is 2048/6000 = 341.3 ms. Bit 10 (LOCKMUTE) allows the ASRCs to automatically mute themselves in the event that lock status is lost or not attained.

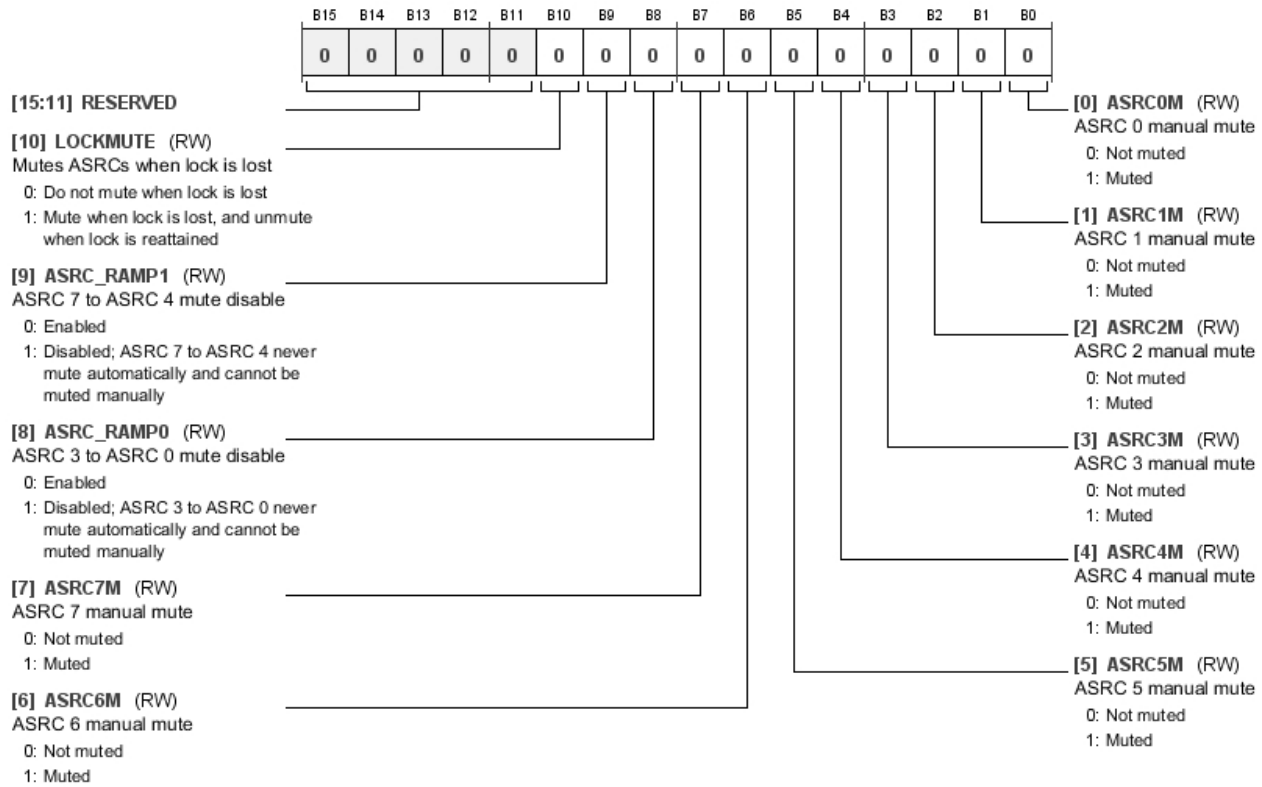

Table 121. Bit Descriptions for ASRC\_MUTE

Bits	Bit Name	Settings	Description	Reset	Access
[15:11]	RESERVED			0x0	RW

Bits	Bit Name	Settings	Description	Reset	Access
10	LOCKMUTE	0 1	Mutes ASRCs when lock is lost. When this bit is enabled, individual stereo ASRCs automatically mute on the event that lock status is lost (for example, if the sample rate of the input suddenly changes and the ASRC needs to regain lock), provided that the corresponding ASRC_RAMPx bit is set to 0b0 (enabled). This automatic mute uses a volume ramp instead of an instantaneous mute to avoid click-and-pop noises on the output. When lock status is attained again (and the corresponding ASRC_RAMPx and ASRCxM bits are set to 0b0 (enabled) and 0b0 (unmuted), respectively), the ASRC automatically unmutes using a volume ramp. However, because there is a period of uncertainty when the ASRC is attaining lock, there still may be noise on the ASRC outputs when the input signal returns. Measures must be taken in the DSP program to delay the unmuting of the ASRC output signals if this noise is not desired. The individual ASRCxM mute bits override the automatic LOCKMUTE behavior. Do not mute when lock is lost Mute when lock is lost, and unmute when lock is regained	0x0	RW
9	ASRC_RAMP1	0 1	ASRC 7 to ASRC 4 mute disable. ASRC 7 to ASRC 4 (Channel 15 to Channel 8) are defined as ASRC Block 1. This bit enables or disables mute ramping for all ASRCs in Block 1. If this bit is 0b1, Bit 7 (ASRC7M), Bit 6 (ASRC6M), Bit 5 (ASRC5M), and Bit 4 (ASRC4M) are ignored, and the outputs of ASRC 7 to ASRC 4 are active at all times. Enabled Disabled; ASRC 7 to ASRC 4 never mute automatically and cannot be muted manually	0x0	RW
8	ASRC_RAMPO	0 1	ASRC 3 to ASRC 0 mute disable. ASRC 3 to ASRC 0 (Channel 7 to Channel 0) are defined as ASRC Block 0. This bit enables or disables mute ramping for all ASRCs in Block 0. If this bit is 0b1, Bit 3 (ASRC3M), Bit 2 (ASRC2M), Bit 1 (ASRC1M), and Bit 0 (ASRC0M) are ignored, and the outputs of ASRC 3 to ASRC 0 are active at all times. Enabled Disabled; ASRC 3 to ASRC 0 never mute automatically and cannot be muted manually	0x0	RW
7	ASRC7M	0 1	ASRC 7 manual mute. Not muted Muted	0x0	RW
6	ASRC6M	0 1	ASRC 6 manual mute. Not muted Muted	0x0	RW
5	ASRC5M	0 1	ASRC 5 manual mute. Not muted Muted	0x0	RW
4	ASRC4M	0 1	ASRC 4 manual mute. Not muted Muted	0x0	RW
3	ASRC3M	0 1	ASRC 3 manual mute. Not muted Muted	0x0	RW
2	ASRC2M	0 1	ASRC 2 manual mute. Not muted Muted	0x0	RW
1	ASRC1M	0 1	ASRC 1 manual mute. Not muted Muted	0x0	RW
0	ASRC0M	0 1	ASRC 0 manual mute. Not muted Muted	0x0	RW

**ASRC Ratio Registers**

**Address: 0xF582 to 0xF589 (Increments of 0x1), Reset: 0x0000, Name: ASRCx\_RATIO**

These eight read only registers contain the sample rate conversion ratio of the corresponding ASRC on the [ADAU1452](#) and [ADAU1451](#), which is calculated as the ratio between the detected input rate and the selected target output rate. The format of the value stored in these registers is 4.12 format. For example, a ratio of 1 is shown as 0b0001000000000000 (0x1000). A ratio of 2 is shown as 0b0010000000000000 (0x2000). A ratio of 0.5 is shown as 0b0000100000000000 (0x0800).

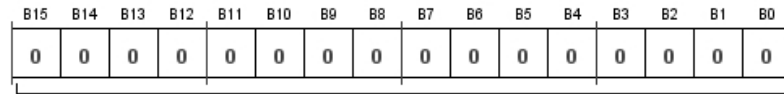

**[15:0] ASRC\_RATIO (RW)**  
Output rate of the ASRC in 4.12 format

**Table 122. Bit Descriptions for ASRCx\_RATIO**

Bits	Bit Name	Settings	Description	Reset	Access
[15:0]	ASRC_RATIO		Output rate of the ASRC in 4.12 format. The value of this register represents the input to output rate of the corresponding ASRC. It is stored in 4.12 format.	0x0000	RW

**AUXILIARY ADC REGISTERS****Auxiliary ADC Read Value Register**

**Address: 0xF5A0 to 0xF5A5 (Increments of 0x1), Reset: 0x0000, Name: ADC\_READx**

These six register contains the output data of the auxiliary ADC for the corresponding channel. Each of the six channels of the ADC are updated once per audio frame. The format for the value in this register is 6.10 format, but the top six bits are always zero, meaning that the effective format is 0.10 format. If, for example, the input to the corresponding auxiliary ADC channel is equal to AVDD (the full-scale analog input voltage), this register reads its maximum value of 0b0000001111111111 (0x3FF). If the input to the auxiliary ADC channel is AVDD/2, this register reads 0b0000001000000000 (0x200). If the input to the auxiliary ADC channel is AVDD/4, this register reads 0b0000000100000000 (0x100).

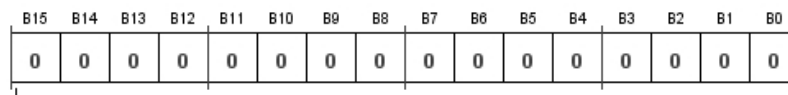

**[15:0] ADC\_VALUE (RW)**  
ADC input value in 0.10 format, as a proportion of AVDD

**Table 123. Bit Descriptions for ADC\_READx**

Bits	Bit Name	Settings	Description	Reset	Access
[15:0]	ADC_VALUE		ADC input value in 0.10 format, as a proportion of AVDD. Instantaneous value of the sampled data on the ADC input. The top six bits are not used, and the least significant 10 bits contain the value of the ADC input. The minimum value of 0 maps to 0V, and the maximum value of 1023 maps to $3.3\text{ V} \pm 10\%$ (equal to the AVDD supply). Values between 0 and 1023 are linearly mapped to dc voltages between 0V and AVDD.	0x0000	RW

**S/PDIF INTERFACE REGISTERS**

**S/PDIF Receiver Lock Bit Detection Register**

Address: 0xF600, Reset: 0x0000, Name: SPDIF\_LOCK\_DET

This register contains a flag that monitors the S/PDIF receiver on the ADAU1452 and ADAU1451 and provides a way to check the validity of the input signal.

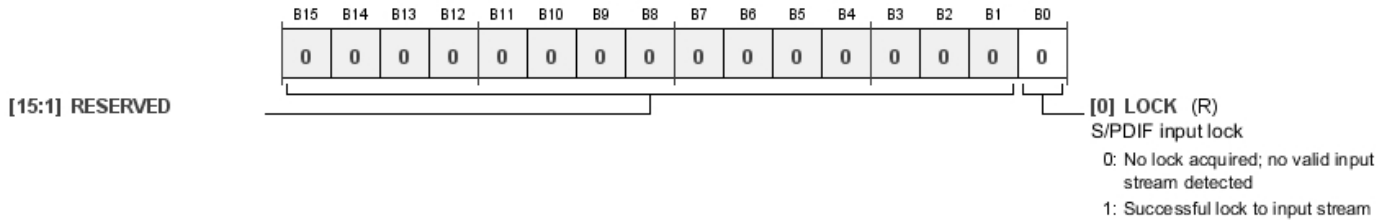

Table 124. Bit Descriptions for SPDIF\_LOCK\_DET

Bits	Bit Name	Settings	Description	Reset	Access
[15:1]	RESERVED			0x0	RW
0	LOCK	0 1	S/PDIF input lock. No lock acquired; no valid input stream detected Successful lock to input stream	0x0	R

**S/PDIF Receiver Control Register**

Address: 0xF601, Reset: 0x0000, Name: SPDIF\_RX\_CTRL

This register provides controls that govern the behavior of the S/PDIF receiver on the ADAU1452 and ADAU1451.

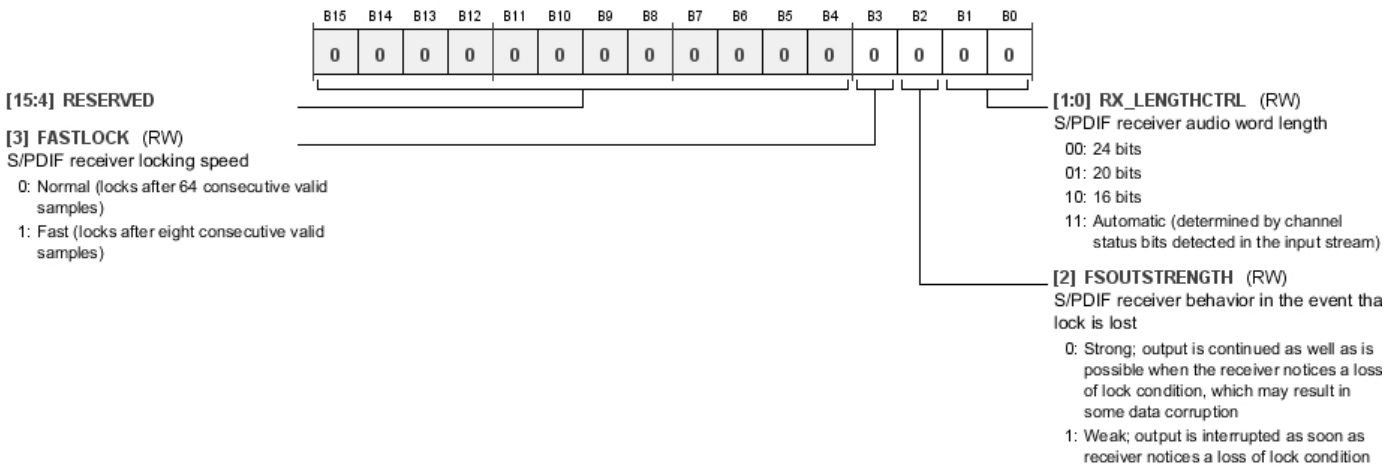

Table 125. Bit Descriptions for SPDIF\_RX\_CTRL

Bits	Bit Name	Settings	Description	Reset	Access
[15:4]	RESERVED			0x0	RW
3	FASTLOCK	0 1	S/PDIF receiver locking speed. Normal (locks after 64 consecutive valid samples) Fast (locks after eight consecutive valid samples)	0x0	RW

Bits	Bit Name	Settings	Description	Reset	Access
2	FSOUTSTRENGTH	0 1	S/PDIF receiver behavior in the event that lock is lost. FSOUTSTRENGTH applies to the output of the recovered frame clock from the S/PDIF receiver. Strong; output is continued as well as is possible when the receiver notices a loss of lock condition, which may result in some data corruption Weak; output is interrupted as soon as receiver notices a loss of lock condition	0x0	RW
[1:0]	RX_LENGTHCTRL	00 01 10 11	S/PDIF receiver audio word length. 24 bits 20 bits 16 bits Automatic (determined by channel status bits detected in the input stream)	0x0	RW

**Decoded Signals From the S/PDIF Receiver Register**

Address: 0xF602, Reset: 0x0000, Name: SPDIF\_RX\_DECODE

This register monitors the embedded nonaudio data bits in the incoming S/PDIF stream on the ADAU1452 and ADAU1451 and decodes them, providing insight into the data format of the S/PDIF input stream.

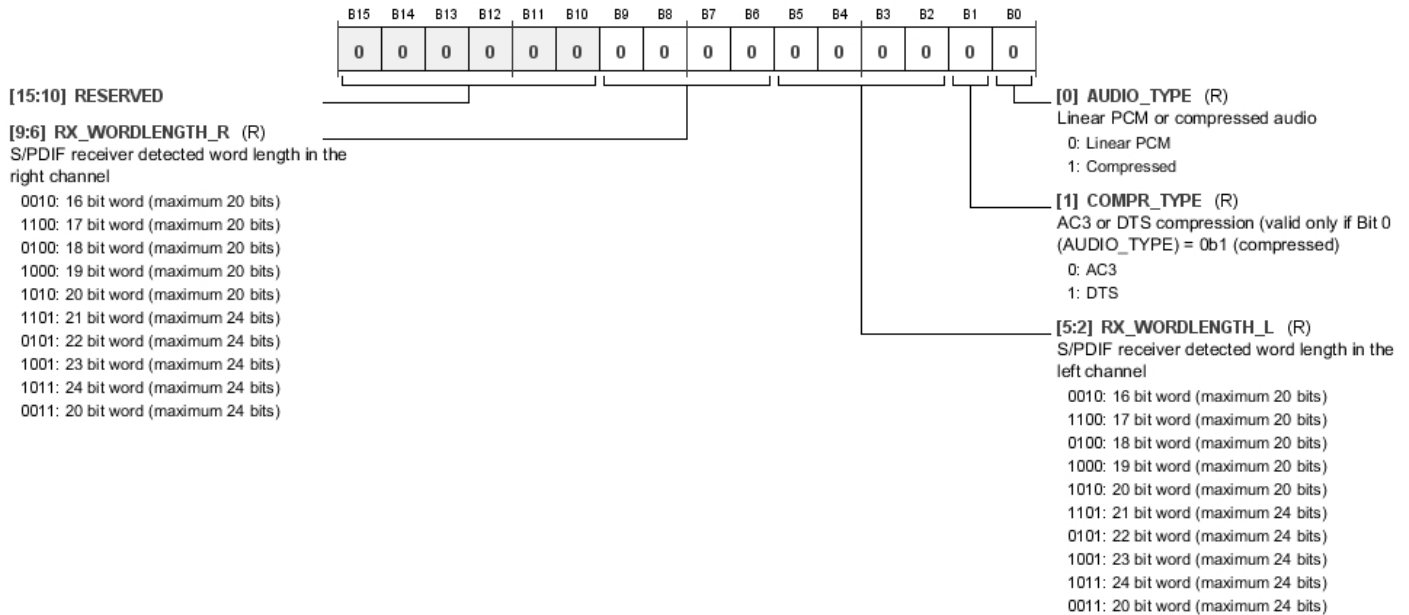

**Table 126. Bit Descriptions for SPDIF\_RX\_DECODE**

Bits	Bit Name	Settings	Description	Reset	Access
[15:10]	RESERVED			0x0	RW
[9:6]	RX_WORDLENGTH_R	0010 1100 0100 1000 1010 1101 0101 1001 1011 0011	S/PDIF receiver detected word length in the right channel. 16 bit word (maximum 20 bits) 17 bit word (maximum 20 bits) 18 bit word (maximum 20 bits) 19 bit word (maximum 20 bits) 20 bit word (maximum 20 bits) 21 bit word (maximum 24 bits) 22 bit word (maximum 24 bits) 23 bit word (maximum 24 bits) 24 bit word (maximum 24 bits) 20 bit word (maximum 24 bits)	0x0	R

Bits	Bit Name	Settings	Description	Reset	Access
[5:2]	RX_WORDLENGTH_L	0010 16 bit word (maximum 20 bits) 1100 17 bit word (maximum 20 bits) 0100 18 bit word (maximum 20 bits) 1000 19 bit word (maximum 20 bits) 1010 20 bit word (maximum 20 bits) 1101 21 bit word (maximum 24 bits) 0101 22 bit word (maximum 24 bits) 1001 23 bit word (maximum 24 bits) 1011 24 bit word (maximum 24 bits) 0011 20 bit word (maximum 24 bits)	S/PDIF receiver detected word length in the left channel.	0x0	R
1	COMPR_TYPE	0 AC3 1 DTS	AC3 or DTS compression (valid only if Bit 0 (AUDIO_TYPE) = 0b1 (compressed)).	0x0	R
0	AUDIO_TYPE	0 Linear PCM 1 Compressed	Linear PCM or compressed audio.	0x0	R

**Compression Mode From the S/PDIF Receiver Register**

Address: 0xF603, Reset: 0x0000, Name: SPDIF\_RX\_COMPRMODE

If the incoming S/PDIF data on the ADAU1452 and ADAU1451 has been encoded using a compression algorithm, this register displays the 16-bit code that represents the type of compression being used.

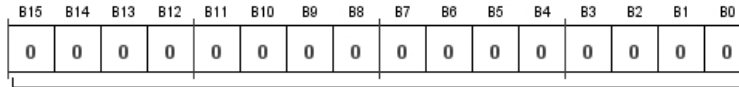

[15:0] COMPR\_MODE (R)  
 Compression mode detected by the S/PDIF receiver

**Table 127. Bit Descriptions for SPDIF\_RX\_COMPRMODE**

Bits	Bit Name	Settings	Description	Reset	Access
[15:0]	COMPR_MODE		Compression mode detected by the S/PDIF receiver.	0x0000	R

**Automatically Resume S/PDIF Receiver Audio Input Register**

**Address: 0xF604, Reset: 0x0000, Name: SPDIF\_RESTART**

When the S/PDIF receiver on the ADAU1452 and ADAU1451 loses lock on the incoming S/PDIF signal, which can occur due to issues with signal integrity, the receiver automatically mutes itself. This register determines whether the S/PDIF receiver then automatically resumes outputting data if the S/PDIF receiver subsequently begins to receive valid data and a lock condition is reattained. By default, the S/PDIF receiver does not automatically resume audio when lock is lost (Register 0xF604 (SPDIF\_RESTART), Bit 0 (RESTART\_AUDIO) = 0b0); and, therefore, the user must manually reset the S/PDIF receiver by toggling Register 0xF604 (SPDIF\_RESTART), Bit 0 (RESTART\_AUDIO), from 0b0 to 0b1 and then back to 0b0 again. To ensure that the S/PDIF receiver always begins outputting data when a valid input signal is detected, set Register 0xF604 (SPDIF\_RESTART), Bit 0 (RESTART\_AUDIO), to 0b1 at all times.

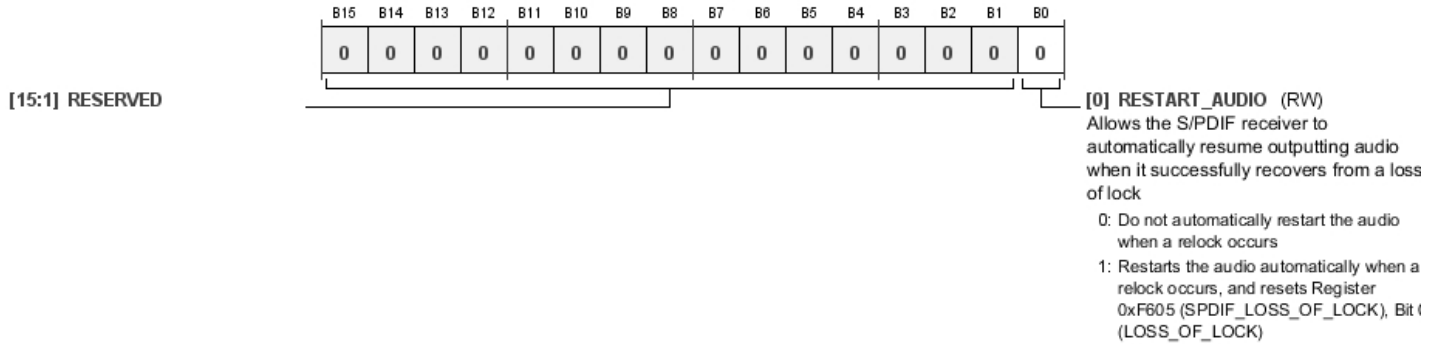

**Table 128. Bit Descriptions for SPDIF\_RESTART**

Bits	Bit Name	Settings	Description	Reset	Access
[15:1]	RESERVED			0x0	RW
0	RESTART_AUDIO	0 1	Allows the S/PDIF receiver to automatically resume outputting audio when it successfully recovers from a loss of lock. 0 Do not automatically restart the audio when a relock occurs 1 Restarts the audio automatically when a relock occurs, and resets Register 0xF605 (SPDIF_LOSS_OF_LOCK), Bit 0 (LOSS_OF_LOCK)	0x0	RW

**S/PDIF Receiver Loss of Lock Detection Register**

Address: 0xF605, Reset: 0x0000, Name: SPDIF\_LOSS\_OF\_LOCK

This bit monitors the S/PDIF lock status and checks to see if the lock is lost during operation of the S/PDIF receiver on the ADAU1452 and ADAU1451. This condition can arise when, for example, a valid S/PDIF input signal was present for an extended period of time, but signal integrity worsened for a brief period, causing the receiver to then lose its lock to the input signal. In this case, Bit 0 (LOSS\_OF\_LOCK) transitions from 0b0 to 0b1 and remains set at 0b1 indefinitely. This indicates that, at some point during the operation of the device, lock to the input stream was lost. Bit 0 (LOSS\_OF\_LOCK) stays high at 0b1 until Register 0xF604 (SPDIF\_RESTART), Bit 0 (RESTART\_AUDIO), is set to 0b1, which clears Bit 0 (LOSS\_OF\_LOCK) back to 0b0. At that point, Register 0xF604 (SPDIF\_RESTART), Bit 0 (RESTART\_AUDIO), can be reset to 0b0 if required.

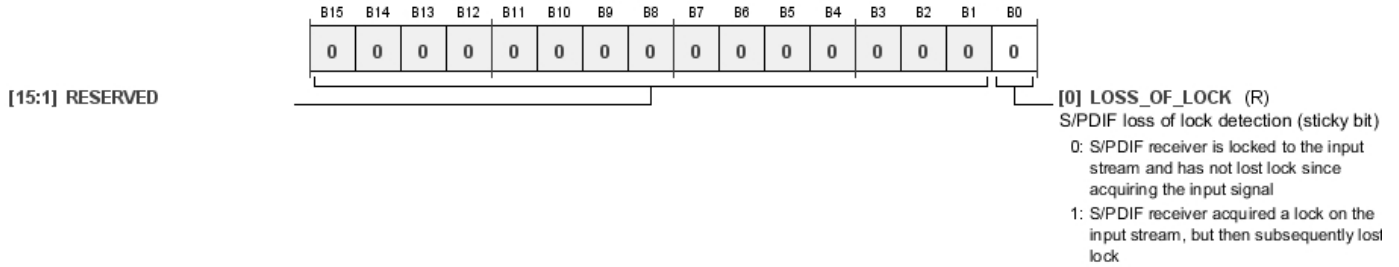

**Table 129. Bit Descriptions for SPDIF\_LOSS\_OF\_LOCK**

Bits	Bit Name	Settings	Description	Reset	Access
[15:1]	RESERVED			0x0	RW
0	LOSS_OF_LOCK	0 1	S/PDIF loss of lock detection (sticky bit). S/PDIF receiver is locked to the input stream and has not lost lock since acquiring the input signal S/PDIF receiver acquired a lock on the input stream but then, subsequently, lost lock	0x0	R



**S/PDIF Receiver Auxiliary Outputs Enable Register**

Address: 0xF608, Reset: 0x0000, Name: SPDIF\_AUX\_EN

The S/PDIF receiver on the ADAU1452 and ADAU1451 decodes embedded nonaudio data bits on the incoming data stream, including channel status, user data, validity bits, and parity bits. This information, together with the decoded audio data, can optionally be output on one of the SDATA\_OUTx pins using Register 0xF608 (SPDIF\_AUX\_EN). The serial output port selected by Bits[3:0] (TDMOUT) outputs an 8-channel TDM stream containing this decoded information.

Channel 0 in the TDM8 stream contains the 24 audio bits from the left S/PDIF input channel, followed by eight zero bits.

Channel 1 in the TDM8 stream contains 20 zero bits, the parity bit, validity bit, user data bit, and the channel status bit from the left S/PDIF input channel, followed by eight zero bits.

Channel 2 in the TDM8 stream contains 22 zero bits, followed by the compression type bit (0b0 represents AC3 and 0b1 represents DTS) and the audio type bit (0b0 represents PCM and 0b1 represents compressed), followed by eight zero bits.

Channel 3 in the TDM8 stream contains 32 zero bits.

Channel 4 in the TDM8 stream contains the 24 audio bits from the right S/PDIF input channel, followed by eight zero bits.

Channel 5 in the TDM8 stream contains 20 zero bits followed by the parity bit, validity bit, user data bit, and channel status bit from the right S/PDIF input channel, followed by eight zero bits.

Channel 6 in the TDM8 stream contains 32 zero bits.

Channel 7 in the TDM8 stream contains 23 zero bits, the block start bit, and eight zero bits.

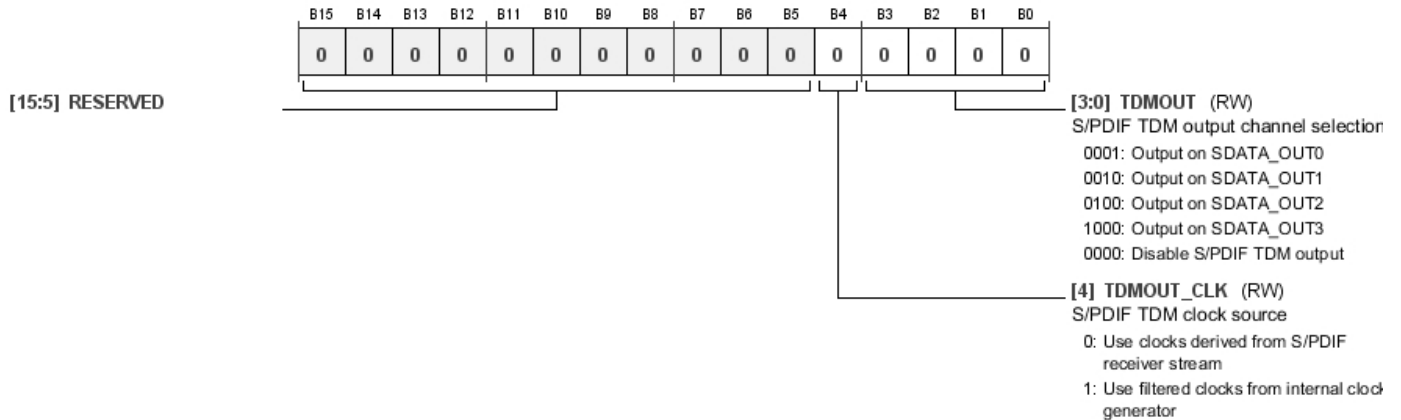

Table 130. Bit Descriptions for SPDIF\_AUX\_EN

Bits	Bit Name	Settings	Description	Reset	Access
[15:5]	RESERVED			0x0	RW
4	TDMOUT_CLK	0 1	S/PDIF TDM clock source. When Bits[3:0] (TDMOUT) are configured to output S/PDIF receiver data on one of the SDATA_OUTx pins, the corresponding serial port must be set in master mode; and Bit 4 (TDMOUT_CLK) configures which clock signals are used on the corresponding BCLK_OUTx and LRCLK_OUTx pins. If Bit 4 (TDMOUT_CLK) = 0b0, the clock signals recovered from the S/PDIF input signal are used to clock the serial output. If Bit 4 (TDMOUT_CLK) = 0b1, the output of Clock Generator 3 is used to clock serial output; and Register 0xF026 (CLK_GEN3_SRC), Bits[3:0] (FREF_PIN), must be 0b1110, and Register 0xF026 (CLK_GEN3_SRC), Bit 4 (CLK_GEN3_SRC), must be 0b1.	0x0	RW
[3:0]	TDMOUT	0001 0010 0100 1000 0000	S/PDIF TDM output channel selection. Output on SDATA_OUT0 Output on SDATA_OUT1 Output on SDATA_OUT2 Output on SDATA_OUT3 Disable S/PDIF TDM output	0x0	RW

**S/PDIF Receiver Auxiliary Bits Ready Flag Register**

Address: 0xF60F, Reset: 0x0000, Name: SPDIF\_RX\_AUXBIT\_READY

The decoded channel status, user data, validity, and parity bits are recovered from the input signal one frame at a time until a full block of 192 frames is received on the ADAU1452 and ADAU1451. When all of the 192 frames are received and decoded, Bit 0 (AUXBITS\_READY), changes state from 0b0 to 0b1, indicating that the full block of data has been recovered and is available to be read from the corresponding registers.

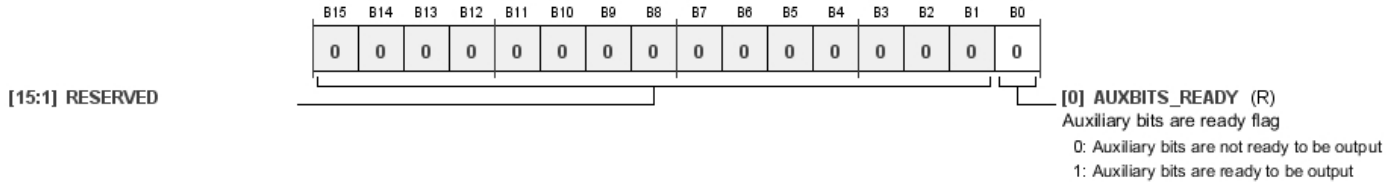

Table 131. Bit Descriptions for SPDIF\_RX\_AUXBIT\_READY

Bits	Bit Name	Settings	Description	Reset	Access
[15:1]	RESERVED			0x0	RW
0	AUXBITS_READY	0 1	Auxiliary bits are ready flag. Auxiliary bits are not ready to be output Auxiliary bits are ready to be output	0x0	R

**S/PDIF Receiver Channel Status Bits (Left) Register**

Address: 0xF610 to 0xF61B (Increments of 0x1), Reset: 0x0000, Name: SPDIF\_RX\_CS\_LEFT\_x

These 12 registers store the 192 channel status bits decoded from the left channel of the S/PDIF input stream on the ADAU1452 and ADAU1451.

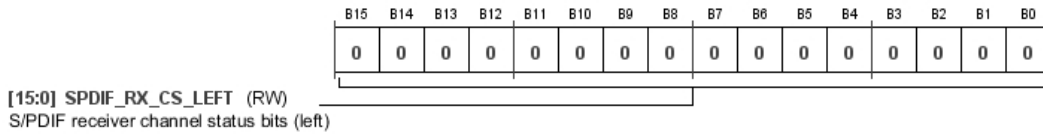

Table 132. Bit Descriptions for SPDIF\_RX\_CS\_LEFT\_x

Bits	Bit Name	Settings	Description	Reset	Access
[15:0]	SPDIF_RX_CS_LEFT		S/PDIF receiver channel status bits (left).	0x0000	R

**S/PDIF Receiver Channel Status Bits (Right) Register**

Address: 0xF620 to 0xF62B (Increments of 0x1), Reset: 0x0000, Name: SPDIF\_RX\_CS\_RIGHT\_x

These 12 registers store the 192 channel status bits decoded from the right channel of the S/PDIF input stream on the ADAU1452 and ADAU1451.

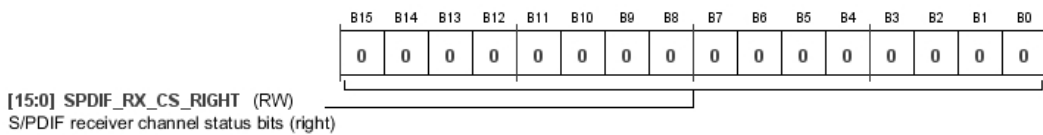

Table 133. Bit Descriptions for SPDIF\_RX\_CS\_RIGHT\_x

Bits	Bit Name	Settings	Description	Reset	Access
[15:0]	SPDIF_RX_CS_RIGHT		S/PDIF receiver channel status bits (right).	0x0000	R

**S/PDIF Receiver User Data Bits (Left) Register**

Address: 0xF630 to 0xF63B (Increments of 0x1), Reset: 0x0000, Name: SPDIF\_RX\_UD\_LEFT\_x

These 12 registers store the 192 user data bits decoded from the left channel of the S/PDIF input stream on the ADAU1452 and ADAU1451.

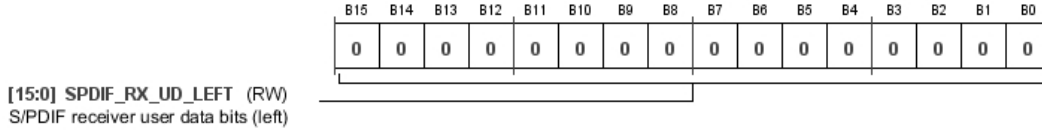

Table 134. Bit Descriptions for SPDIF\_RX\_UD\_LEFT\_x

Bits	Bit Name	Settings	Description	Reset	Access
[15:0]	SPDIF_RX_UD_LEFT		S/PDIF receiver user data bits (left).	0x0000	R

**S/PDIF Receiver User Data Bits (Right) Register**

Address: 0xF640 to 0xF64B (Increments of 0x1), Reset: 0x0000, Name: SPDIF\_RX\_UD\_RIGHT\_x

These 12 registers store the 192 user data bits decoded from the right channel of the S/PDIF input stream on the ADAU1452 and ADAU1451.

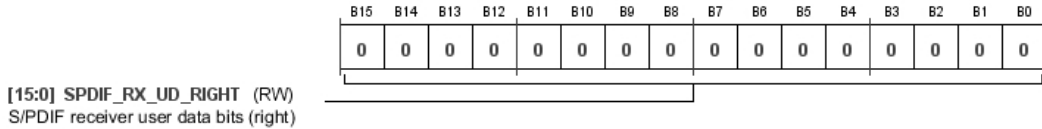

Table 135. Bit Descriptions for SPDIF\_RX\_UD\_RIGHT\_x

Bits	Bit Name	Settings	Description	Reset	Access
[15:0]	SPDIF_RX_UD_RIGHT		S/PDIF receiver user data bits (right).	0x0000	R

**S/PDIF Receiver Validity Bits (Left) Register**

Address: 0xF650 to 0xF65B (Increments of 0x1), Reset: 0x0000, Name: SPDIF\_RX\_VB\_LEFT\_x

These 12 registers store the 192 validity bits decoded from the left channel of the S/PDIF input stream on the ADAU1452 and ADAU1451.

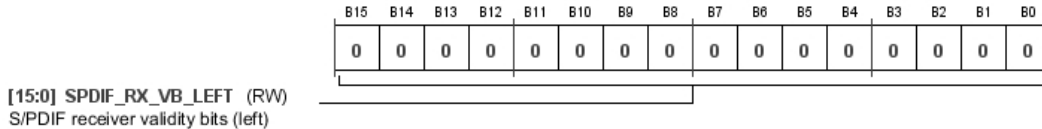

Table 136. Bit Descriptions for SPDIF\_RX\_VB\_LEFT\_x

Bits	Bit Name	Settings	Description	Reset	Access
[15:0]	SPDIF_RX_VB_LEFT		S/PDIF receiver validity bits (left).	0x0000	R

### S/PDIF Receiver Validity Bits (Right) Register

Address: 0xF660 to 0xF66B (Increments of 0x1), Reset: 0x0000, Name: SPDIF\_RX\_VB\_RIGHT\_x

These 12 registers store the 192 validity bits decoded from the left channel of the S/PDIF input stream on the [ADAU1452](#) and [ADAU1451](#).

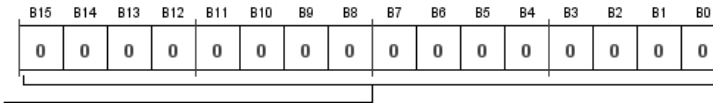

[15:0] SPDIF\_RX\_VB\_RIGHT (RW)  
S/PDIF receiver validity bits (right)

Table 137. Bit Descriptions for SPDIF\_RX\_VB\_RIGHT\_x

Bits	Bit Name	Settings	Description	Reset	Access
[15:0]	SPDIF_RX_VB_RIGHT		S/PDIF receiver validity bits (right).	0x0000	R

### S/PDIF Receiver Parity Bits (Left) Register

Address: 0xF670 to 0xF67B (Increments of 0x1), Reset: 0x0000, Name: SPDIF\_RX\_PB\_LEFT\_x

These 12 registers store the 192 parity bits decoded from the left channel of the S/PDIF input stream on the [ADAU1452](#) and [ADAU1451](#).



[15:0] SPDIF\_RX\_PB\_LEFT (RW)  
S/PDIF receiver parity bits (left)

Table 138. Bit Descriptions for SPDIF\_RX\_PB\_LEFT\_x

Bits	Bit Name	Settings	Description	Reset	Access
[15:0]	SPDIF_RX_PB_LEFT		S/PDIF receiver parity bits (left).	0x0000	R

### S/PDIF Receiver Parity Bits (Right) Register

Address: 0xF680 to 0xF68B (Increments of 0x1), Reset: 0x0000, Name: SPDIF\_RX\_PB\_RIGHT\_x

These 12 registers store the 192 parity bits decoded from the right channel of the S/PDIF input stream on the [ADAU1452](#) and [ADAU1451](#).



[15:0] SPDIF\_RX\_PB\_RIGHT (RW)  
S/PDIF receiver parity bits (right)

Table 139. Bit Descriptions for SPDIF\_RX\_PB\_RIGHT\_x

Bits	Bit Name	Settings	Description	Reset	Access
[15:0]	SPDIF_RX_PB_RIGHT		S/PDIF receiver parity bits (right).	0x0000	R

**S/PDIF Transmitter Enable Register**

Address: 0xF690, Reset: 0x0000, Name: SPDIF\_TX\_EN

This register enables or disables the S/PDIF transmitter on the ADAU1452 and ADAU1451. When the transmitter is disabled, it outputs a constant stream of zero data. When the S/PDIF transmitter is disabled, it still consumes power. To power down the S/PDIF transmitter for the purpose of power savings, set Register 0xF051 (POWER\_ENABLE1), Bit 2 (TX\_PWR) = 0b0.

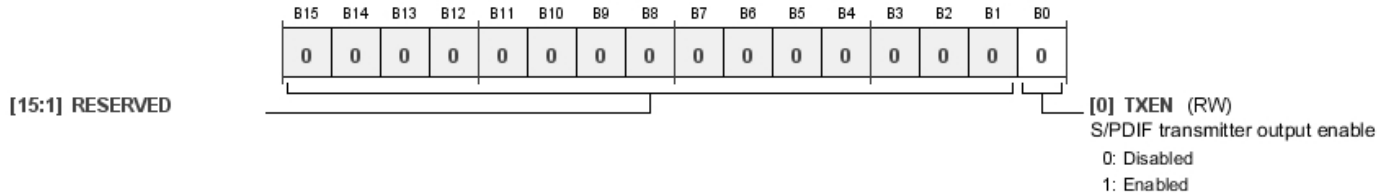

Table 140. Bit Descriptions for SPDIF\_TX\_EN

Bits	Bit Name	Settings	Description	Reset	Access
[15:1]	RESERVED			0x0	RW
0	TXEN	0 1	S/PDIF transmitter output enable. Disabled Enabled	0x0	RW

**S/PDIF Transmitter Control Register**

Address: 0xF691, Reset: 0x0000, Name: SPDIF\_TX\_CTRL

This register controls the length of the audio data-words output by the S/PDIF transmitter on the ADAU1452 and ADAU1451. The maximum word length is 24 bits. If a shorter word length is selected using Bits[1:0] (TX\_LENGTHCTRL), the extraneous bits are truncated, starting with the least significant bit. If Bits[1:0] (TX\_LENGTHCTRL) = 0b11, the decoded channel status bits on the input stream of the S/PDIF receiver automatically set the word length on the S/PDIF transmitter.

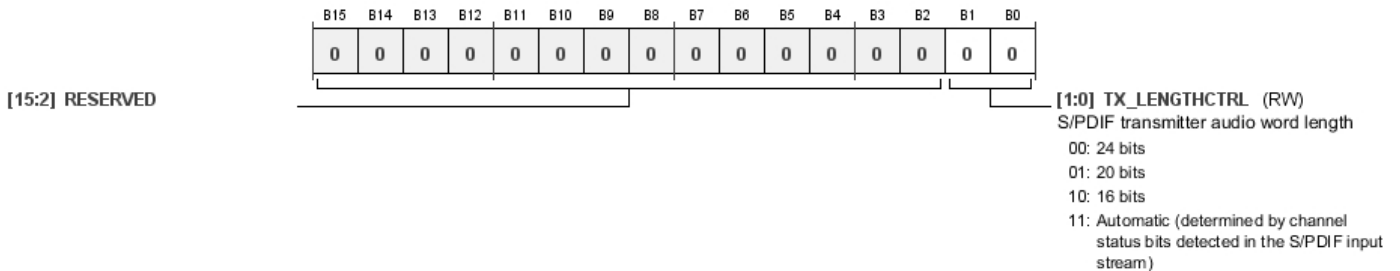

Table 141. Bit Descriptions for SPDIF\_TX\_CTRL

Bits	Bit Name	Settings	Description	Reset	Access
[15:2]	RESERVED			0x0	RW
[1:0]	TX_LENGTHCTRL	00 01 10 11	S/PDIF transmitter audio word length. 24 bits 20 bits 16 bits Automatic (determined by channel status bits detected in the S/PDIF input stream)	0x0	RW

**S/PDIF Transmitter Auxiliary Bits Source Select Register**

Address: 0xF69F, Reset: 0x0000, Name: SPDIF\_TX\_AUXBIT\_SOURCE

This register configures whether the encoded nonaudio data bits in the output data stream of the S/PDIF transmitter on the ADAU1452 and ADAU1451 are copied directly from the S/PDIF receiver or set manually using the corresponding control registers. If the data is configured manually, all channel status, parity, user data, and validity bits can be manually set using the following registers: SPDIF\_TX\_CS\_LEFT\_x, SPDIF\_TX\_CS\_RIGHT\_x, SPDIF\_TX\_UD\_LEFT\_x, SPDIF\_TX\_UD\_RIGHT\_x, SPDIF\_TX\_VB\_LEFT\_x, SPDIF\_TX\_VB\_RIGHT\_x, SPDIF\_TX\_PB\_LEFT\_x, and SPDIF\_TX\_PB\_RIGHT\_x.

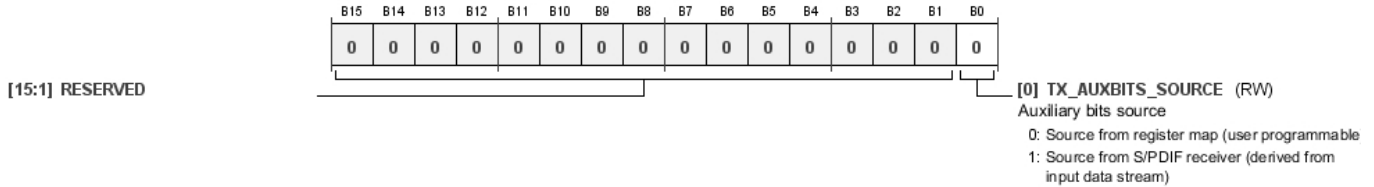

Table 142. Bit Descriptions for SPDIF\_TX\_AUXBIT\_SOURCE

Bits	Bit Name	Settings	Description	Reset	Access
[15:1]	RESERVED			0x0	RW
0	TX_AUXBITS_SOURCE	0 1	Auxiliary bits source. 0 Source from register map (user programmable) 1 Source from S/PDIF receiver (derived from input data stream)	0x0	RW

**S/PDIF Transmitter Channel Status Bits (Left) Register**

Address: 0xF6A0 to 0xF6AB (Increments of 0x1), Reset: 0x0000, Name: SPDIF\_TX\_CS\_LEFT\_x

These 12 registers allow the 192 channel status bits encoded on the left channel of the output data stream of the S/PDIF transmitter on the ADAU1452 and ADAU1451 to be manually configured. For these bits to be output properly on the S/PDIF transmitter, Register 0xF69F (SPDIF\_TX\_AUXBIT\_SOURCE), Bit 0 (TX\_AUXBITS\_SOURCE), must be set to 0b0.

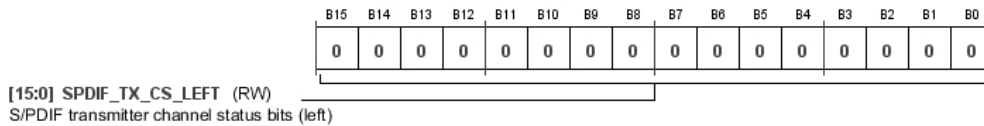

Table 143. Bit Descriptions for SPDIF\_TX\_CS\_LEFT\_x

Bits	Bit Name	Settings	Description	Reset	Access
[15:0]	SPDIF_TX_CS_LEFT		S/PDIF transmitter channel status bits (left).	0x0000	RW

**S/PDIF Transmitter Channel Status Bits (Right) Register**

Address: 0xF6B0 to 0xF6BB (Increments of 0x1), Reset: 0x0000, Name: SPDIF\_TX\_CS\_RIGHT\_x

These 12 registers allow the 192 channel status bits encoded on the right channel of the output data stream of the S/PDIF transmitter on the ADAU1452 and ADAU1451 to be manually configured. For these bits to be output properly on the S/PDIF transmitter, Register 0xF69F (SPDIF\_TX\_AUXBIT\_SOURCE), Bit 0 (TX\_AUXBITS\_SOURCE), must be set to 0b0.

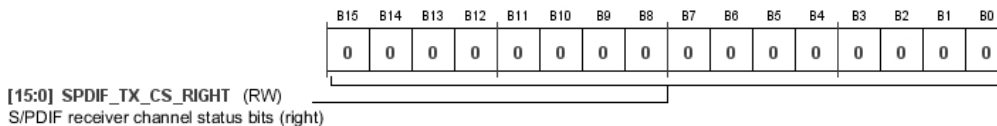

Table 144. Bit Descriptions for SPDIF\_TX\_CS\_RIGHT\_x

Bits	Bit Name	Settings	Description	Reset	Access
[15:0]	SPDIF_TX_CS_RIGHT		S/PDIF receiver channel status bits (right).	0x0000	RW

**S/PDIF Transmitter User Data Bits (Left) Register**

Address: 0xF6C0 to 0xF6CB (Increments of 0x1), Reset: 0x0000, Name: SPDIF\_TX\_UD\_LEFT\_x

These 12 registers allow the 192 user data bits encoded on the left channel of the output data stream of the S/PDIF transmitter on the ADAU1452 and ADAU1451 to be manually configured. For these bits to be output properly on the S/PDIF transmitter, Register 0xF69F (SPDIF\_TX\_AUXBIT\_SOURCE), Bit 0 (TX\_AUXBITS\_SOURCE), must be set to 0b0.

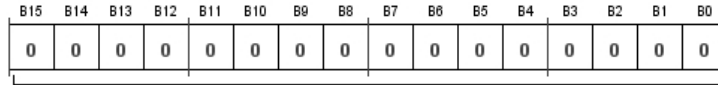

[15:0] SPDIF\_TX\_UD\_LEFT (RW)  
S/PDIF transmitter user data bits (left)

**Table 145. Bit Descriptions for SPDIF\_TX\_UD\_LEFT\_x**

Bits	Bit Name	Settings	Description	Reset	Access
[15:0]	SPDIF_TX_UD_LEFT		S/PDIF transmitter user data bits (left).	0x0000	RW

**S/PDIF Transmitter User Data Bits (Right) Register**

Address: 0xF6D0 to 0xF6DB (Increments of 0x1), Reset: 0x0000, Name: SPDIF\_TX\_UD\_RIGHT\_x

These 12 registers allow the 192 user data bits encoded on the right channel of the output data stream of the S/PDIF transmitter on the ADAU1452 and ADAU1451 to be manually configured. For these bits to be output properly on the S/PDIF transmitter, Register 0xF69F (SPDIF\_TX\_AUXBIT\_SOURCE), Bit 0 (TX\_AUXBITS\_SOURCE), must be set to 0b0.

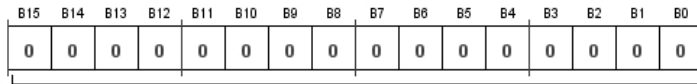

[15:0] SPDIF\_TX\_UD\_RIGHT (RW)  
S/PDIF transmitter user data bits (right)

**Table 146. Bit Descriptions for SPDIF\_TX\_UD\_RIGHT\_x**

Bits	Bit Name	Settings	Description	Reset	Access
[15:0]	SPDIF_TX_UD_RIGHT		S/PDIF transmitter user data bits (right).	0x0000	RW

**S/PDIF Transmitter Validity Bits (Left) Register**

Address: 0xF6E0 to 0xF6EB (Increments of 0x1), Reset: 0x0000, Name: SPDIF\_TX\_VB\_LEFT\_x

These 12 registers allow the 192 validity bits encoded on the left channel of the output data stream of the S/PDIF transmitter on the ADAU1452 and ADAU1451 to be manually configured. For these bits to be output properly on the S/PDIF transmitter, Register 0xF69F (SPDIF\_TX\_AUXBIT\_SOURCE), Bit 0 (TX\_AUXBITS\_SOURCE), must be set to 0b0.

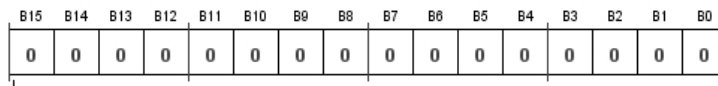

[15:0] SPDIF\_TX\_VB\_LEFT (RW)  
S/PDIF transmitter validity bits (left)

**Table 147. Bit Descriptions for SPDIF\_TX\_VB\_LEFT\_x**

Bits	Bit Name	Settings	Description	Reset	Access
[15:0]	SPDIF_TX_VB_LEFT		S/PDIF transmitter validity bits (left).	0x0000	RW

### S/PDIF Transmitter Validity Bits (Right) Register

Address: 0xF6F0 to 0xF6FB (Increments of 0x1), Reset: 0x0000, Name: SPDIF\_TX\_VB\_RIGHT\_x

These 12 registers allow the 192 validity bits encoded on the right channel of the output data stream of the S/PDIF transmitter on the ADAU1452 and ADAU1451 to be manually configured. For these bits to be output properly on the S/PDIF transmitter, Register 0xF69F (SPDIF\_TX\_AUXBIT\_SOURCE), Bit 0 (TX\_AUXBITS\_SOURCE), must be set to 0b0.

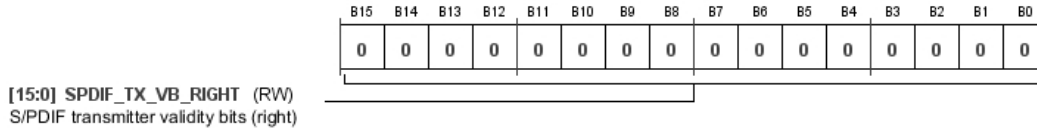

Table 148. Bit Descriptions for SPDIF\_TX\_VB\_RIGHT\_x

Bits	Bit Name	Settings	Description	Reset	Access
[15:0]	SPDIF_TX_VB_RIGHT		S/PDIF transmitter validity bits (right).	0x0000	RW

### S/PDIF Transmitter Parity Bits (Left) Register

Address: 0xF700 to Address 0xF70B (Increments of 0x1), Reset: 0x0000, Name: SPDIF\_TX\_PB\_LEFT\_x

These 12 registers allow the 192 parity bits encoded on the left channel of the output data stream of the S/PDIF transmitter on the ADAU1452 and ADAU1451 to be manually configured. For these bits to be output properly on the S/PDIF transmitter, Register 0xF69F (SPDIF\_TX\_AUXBIT\_SOURCE), Bit 0 (TX\_AUXBITS\_SOURCE), must be set to 0b0.

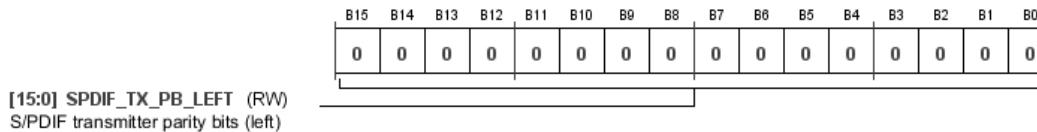

Table 149. Bit Descriptions for SPDIF\_TX\_PB\_LEFT\_x

Bits	Bit Name	Settings	Description	Reset	Access
[15:0]	SPDIF_TX_PB_LEFT		S/PDIF transmitter parity bits (left).	0x0000	RW

### S/PDIF Transmitter Parity Bits (Right) Register

Address: 0xF710 to Address 0xF71B (Increments of 0x1), Reset: 0x0000, Name: SPDIF\_TX\_PB\_RIGHT\_x

These 12 registers allow the 192 parity bits encoded on the right channel of the output data stream of the S/PDIF transmitter on the ADAU1452 and ADAU1451 to be manually configured. For these bits to be output properly on the S/PDIF transmitter, Register 0xF69F (SPDIF\_TX\_AUXBIT\_SOURCE), Bit 0 (TX\_AUXBITS\_SOURCE), must be set to 0b0.

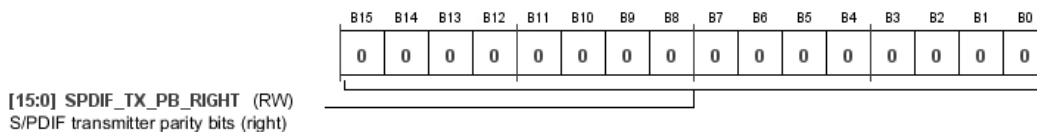

Table 150. Bit Descriptions for SPDIF\_TX\_PB\_RIGHT\_x

Bits	Bit Name	Settings	Description	Reset	Access
[15:0]	SPDIF_TX_PB_RIGHT		S/PDIF transmitter parity bits (right).	0x0000	RW



**HARDWARE INTERFACING REGISTERS**

***BCLK Input Pins Drive Strength and Slew Rate Register***

Address: 0xF780 to 0xF783 (Increments of 0x1), Reset: 0x0018, Name: BCLK\_INx\_PIN

These registers configure the drive strength, slew rate, and pull resistors for the BCLK\_INx pins. Register 0xF780 corresponds to BCLK\_IN0, Register 0xF781 corresponds to BCLK\_IN1, Register 0xF782 corresponds to BCLK\_IN2, and Register 0xF783 corresponds to BCLK\_IN3.

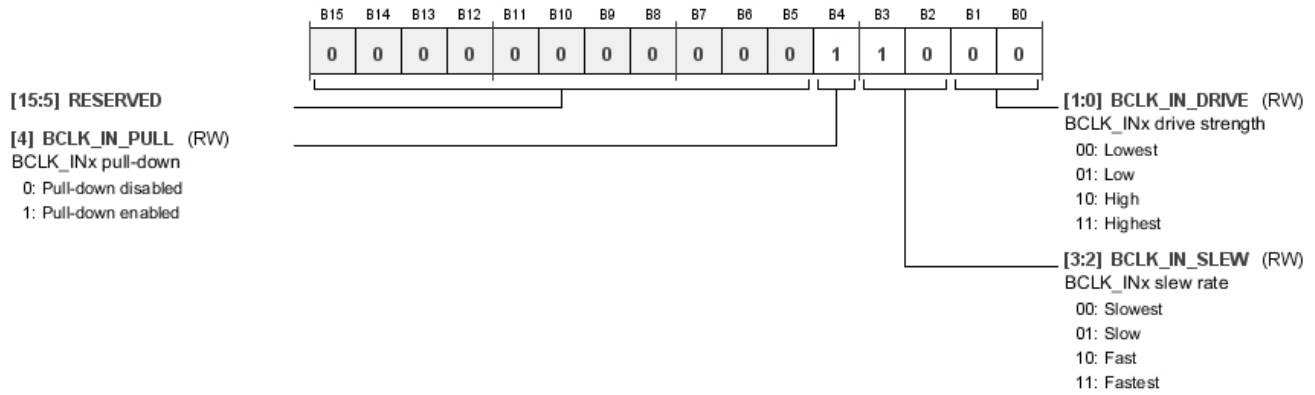

**Table 151. Bit Descriptions for BCLK\_INx\_PIN**

Bits	Bit Name	Settings	Description	Reset	Access
[15:5]	RESERVED			0x0	RW
4	BCLK_IN_PULL	0 1	BCLK_INx pull-down. Pull-down disabled Pull-down enabled	0x1	RW
[3:2]	BCLK_IN_SLEW	00 01 10 11	BCLK_INx slew rate. Slowest Slow Fast Fastest	0x2	RW
[1:0]	BCLK_IN_DRIVE	00 01 10 11	BCLK_INx drive strength. Lowest Low High Highest	0x0	RW

**BCLK Output Pins Drive Strength and Slew Rate Register**

Address: 0xF784 to 0xF787 (Increments of 0x1), Reset: 0x0018, Name: BCLK\_OUTx\_PIN

These registers configure the drive strength, slew rate, and pull resistors for the BCLK\_OUTx pins. Register 0xF784 corresponds to BCLK\_OUT0, Register 0xF785 corresponds to BCLK\_OUT1, Register 0xF786 corresponds to BCLK\_OUT2, and Register 0xF787 corresponds to BCLK\_OUT3.

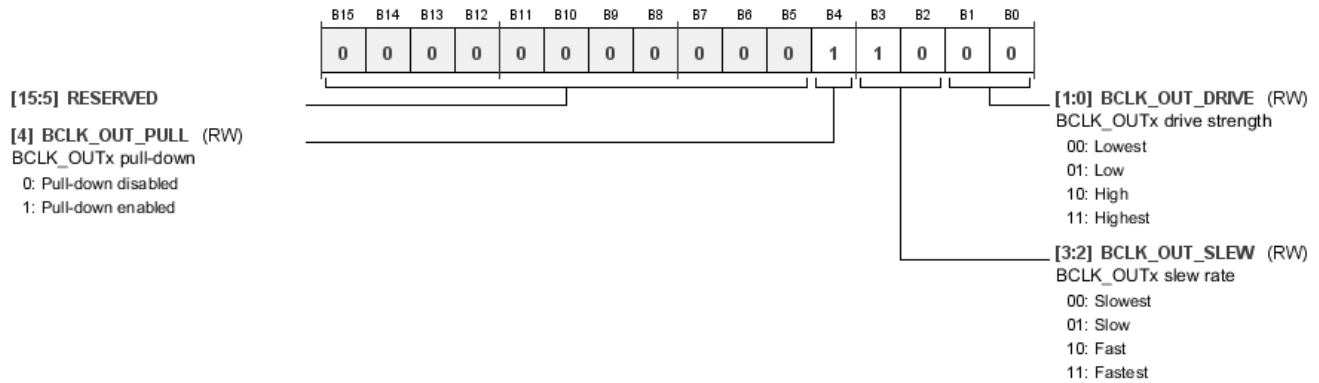

Table 152. Bit Descriptions for BCLK\_OUTx\_PIN

Bits	Bit Name	Settings	Description	Reset	Access
[15:5]	RESERVED			0x0	RW
4	BCLK_OUT_PULL	0 1	BCLK_OUTx pull-down. Pull-down disabled Pull-down enabled	0x1	RW
[3:2]	BCLK_OUT_SLEW	00 01 10 11	BCLK_OUTx slew rate. Slowest Slow Fast Fastest	0x2	RW
[1:0]	BCLK_OUT_DRIVE	00 01 10 11	BCLK_OUTx drive strength. Lowest Low High Highest	0x0	RW

**LRCLK Input Pins Drive Strength and Slew Rate Register**

Address: 0xF788 to 0xF78B (Increments of 0x1), Reset: 0x0018, Name: LRCLK\_INx\_PIN

These registers configure the drive strength, slew rate, and pull resistors for the LRCLK\_INx pins. Register 0xF788 corresponds to LRCLK\_IN0/MP10, Register 0xF789 corresponds to LRCLK\_IN1/MP11, Register 0xF78A corresponds to LRCLK\_IN2/MP12, and Register 0xF78B corresponds to LRCLK\_IN3/MP13.

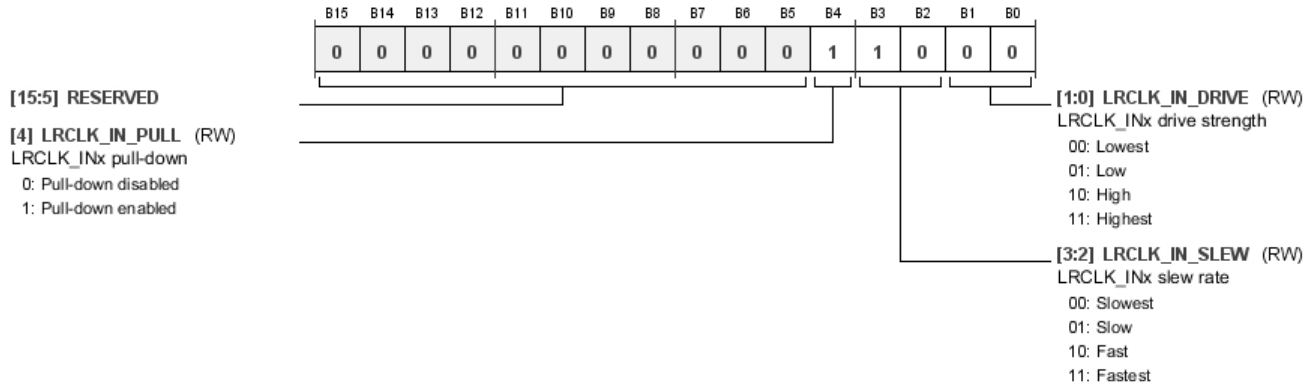

**Table 153. Bit Descriptions for LRCLK\_INx\_PIN**

Bits	Bit Name	Settings	Description	Reset	Access
[15:5]	RESERVED			0x0	RW
4	LRCLK_IN_PULL	0 1	LRCLK_INx pull-down. 0 Pull-down disabled 1 Pull-down enabled	0x1	RW
[3:2]	LRCLK_IN_SLEW	00 01 10 11	LRCLK_INx slew rate. 00 Slowest 01 Slow 10 Fast 11 Fastest	0x2	RW
[1:0]	LRCLK_IN_DRIVE	00 01 10 11	LRCLK_INx drive strength. 00 Lowest 01 Low 10 High 11 Highest	0x0	RW

**LRCLK Output Pins Drive Strength and Slew Rate Register**

Address: 0xF78C to 0xF78F (Increments of 0x1), Reset: 0x0018, Name: LRCLK\_OUTx\_PIN

These registers configure the drive strength, slew rate, and pull resistors for the LRCLK\_OUTx pins. Register 0xF78C corresponds to LRCLK\_OUT0/MP4, Register 0xF78D corresponds to LRCLK\_OUT1/MP5, Register 0xF78E corresponds to LRCLK\_OUT2/MP8, and Register 0xF78F corresponds to LRCLK\_OUT3/MP9.

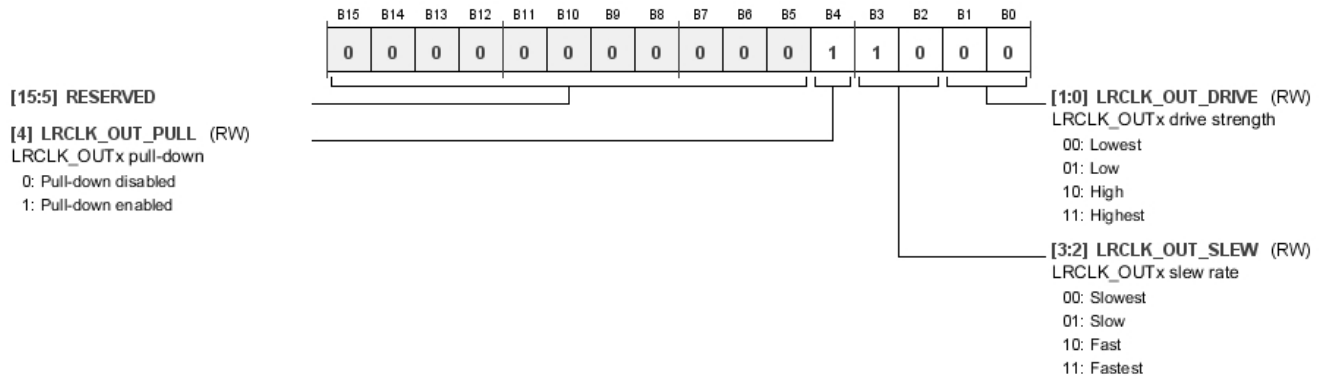

**Table 154. Bit Descriptions for LRCLK\_OUTx\_PIN**

Bits	Bit Name	Settings	Description	Reset	Access
[15:5]	RESERVED			0x0	RW
4	LRCLK_OUT_PULL	0 1	LRCLK_OUTx pull-down. Pull-down disabled Pull-down enabled	0x1	RW
[3:2]	LRCLK_OUT_SLEW	00 01 10 11	LRCLK_OUTx slew rate. Slowest Slow Fast Fastest	0x2	RW
[1:0]	LRCLK_OUT_DRIVE	00 01 10 11	LRCLK_OUTx drive strength. Lowest Low High Highest	0x0	RW

**SDATA Input Pins Drive Strength and Slew Rate Register**

Address: 0xF790 to 0xF793 (Increments of 0x1), Reset: 0x0018, Name: SDATA\_INx\_PIN

These registers configure the drive strength, slew rate, and pull resistors for the SDATA\_INx pins. Register 0xF790 corresponds to SDATA\_IN0, Register 0xF791 corresponds to SDATA\_IN1, Register 0xF792 corresponds to SDATA\_IN2, and Register 0xF793 corresponds to SDATA\_IN3.

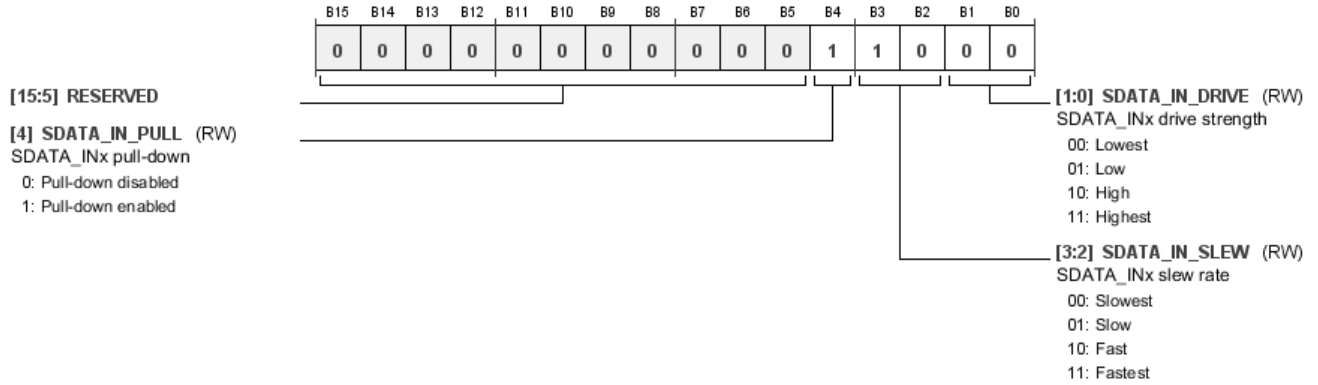

**Table 155. Bit Descriptions for SDATA\_INx\_PIN**

Bits	Bit Name	Settings	Description	Reset	Access
[15:5]	RESERVED			0x0	RW
4	SDATA_IN_PULL	0 1	SDATA_INx pull-down. Pull-down disabled Pull-down enabled	0x1	RW
[3:2]	SDATA_IN_SLEW	00 01 10 11	SDATA_INx slew rate. Slowest Slow Fast Fastest	0x2	RW
[1:0]	SDATA_IN_DRIVE	00 01 10 11	SDATA_INx drive strength. Lowest Low High Highest	0x0	RW

**SDATA Output Pins Drive Strength and Slew Rate Register**

Address: 0xF794 to 0xF797 (Increments of 0x1), Reset: 0x0008, Name: SDATA\_OUTx\_PIN

These registers configure the drive strength, slew rate, and pull resistors for the SDATA\_OUTx pins. Register 0xF794 corresponds to SDATA\_OUT0, Register 0xF795 corresponds to SDATA\_OUT1, Register 0xF796 corresponds to SDATA\_OUT2, and Register 0xF797 corresponds to SDATA\_OUT3.

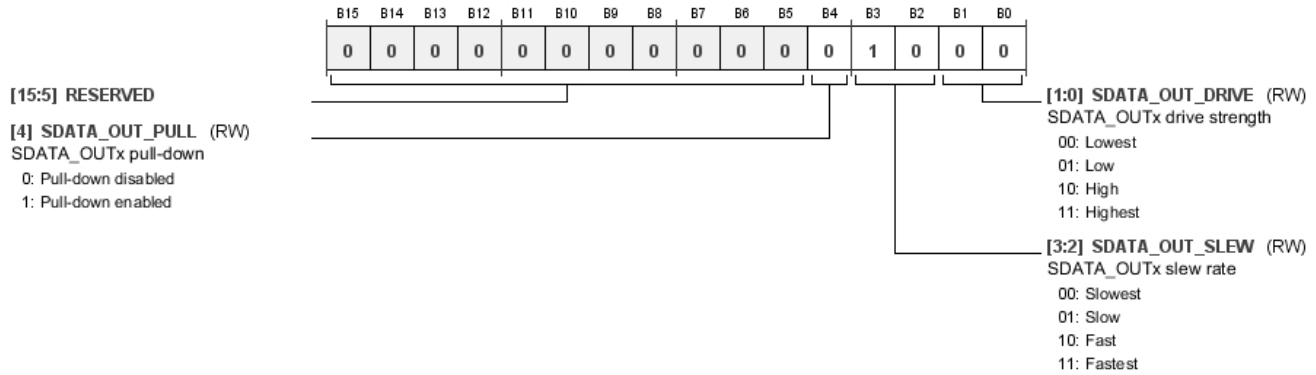

**Table 156. Bit Descriptions for SDATA\_OUTx\_PIN**

Bits	Bit Name	Settings	Description	Reset	Access
[15:5]	RESERVED			0x0	RW
4	SDATA_OUT_PULL	0 1	SDATA_OUTx pull-down. Pull-down disabled Pull-down enabled	0x0	RW
[3:2]	SDATA_OUT_SLEW	00 01 10 11	SDATA_OUTx slew rate. Slowest Slow Fast Fastest	0x2	RW
[1:0]	SDATA_OUT_DRIVE	00 01 10 11	SDATA_OUTx drive strength. Lowest Low High Highest	0x0	RW

**S/PDIF Transmitter Pin Drive Strength and Slew Rate Register**

Address: 0xF798, Reset: 0x0008, Name: SPDIF\_TX\_PIN

This register configures the drive strength, slew rate, and pull resistors for the SPDIFOUT pin on the ADAU1452 and ADAU1451.

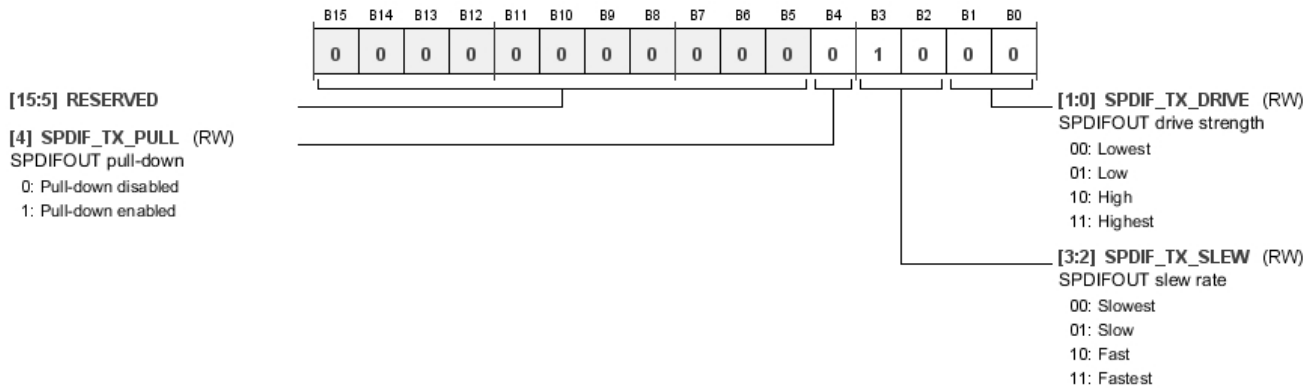

**Table 157. Bit Descriptions for SPDIF\_TX\_PIN**

Bits	Bit Name	Settings	Description	Reset	Access
[15:5]	RESERVED			0x0	RW
4	SPDIF_TX_PULL	0 1	SPDIFOUT pull-down. Pull-down disabled Pull-down enabled	0x0	RW
[3:2]	SPDIF_TX_SLEW	00 01 10 11	SPDIFOUT slew rate. Slowest Slow Fast Fastest	0x2	RW
[1:0]	SPDIF_TX_DRIVE	00 01 10 11	SPDIFOUT drive strength. Lowest Low High Highest	0x0	RW

**SCLK/SCL Pin Drive Strength and Slew Rate Register**

Address: 0xF799, Reset: 0x0008, Name: SCLK\_SCL\_PIN

This register configures the drive strength, slew rate, and pull resistors for the SCLK/SCL pin.

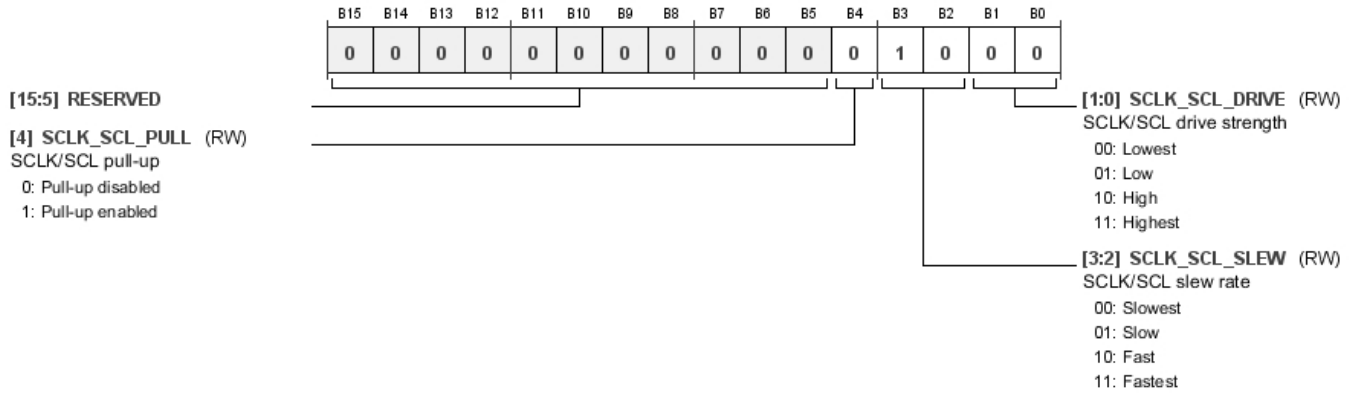

Table 158. Bit Descriptions for SCLK\_SCL\_PIN

Bits	Bit Name	Settings	Description	Reset	Access
[15:5]	RESERVED			0x0	RW
4	SCLK_SCL_PULL	0 1	SCLK/SCL pull-up. Pull-up disabled Pull-up enabled	0x0	RW
[3:2]	SCLK_SCL_SLEW	00 01 10 11	SCLK/SCL slew rate. Slowest Slow Fast Fastest	0x2	RW
[1:0]	SCLK_SCL_DRIVE	00 01 10 11	SCLK/SCL drive strength. Lowest Low High Highest	0x0	RW



**MISO/SDA Pin Drive Strength and Slew Rate Register**

Address: 0xF79A, Reset: 0x0008, Name: MISO\_SDA\_PIN

This register configures the drive strength, slew rate, and pull resistors for the MISO/SDA pin.

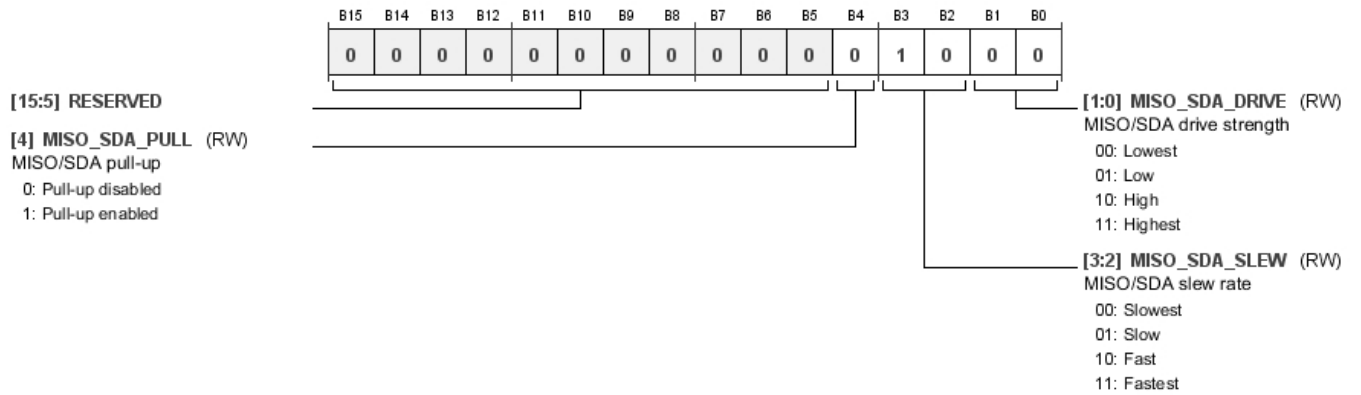

Table 159. Bit Descriptions for MISO\_SDA\_PIN

Bits	Bit Name	Settings	Description	Reset	Access
[15:5]	RESERVED			0x0	RW
4	MISO_SDA_PULL	0 1	MISO/SDA pull-up. Pull-up disabled Pull-up enabled	0x0	RW
[3:2]	MISO_SDA_SLEW	00 01 10 11	MISO/SDA slew rate. Slowest Slow Fast Fastest	0x2	RW
[1:0]	MISO_SDA_DRIVE	00 01 10 11	MISO/SDA drive strength. Lowest Low High Highest	0x0	RW

**SS/ADDR0 Pin Drive Strength and Slew Rate Register**

Address: 0xF79B, Reset: 0x0018, Name: SS\_PIN

This register configures the drive strength, slew rate, and pull resistors for the SS/ADDR0 pin.

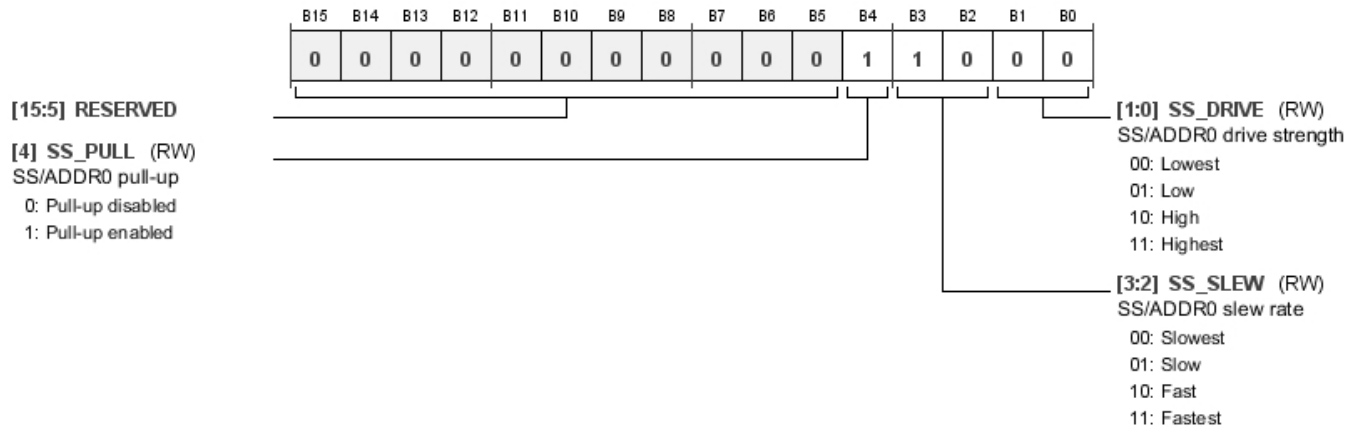

**Table 160. Bit Descriptions for SS\_PIN**

Bits	Bit Name	Settings	Description	Reset	Access
[15:5]	RESERVED			0x0	RW
4	SS_PULL	0 1	SS/ADDR0 pull-up. Pull-up disabled Pull-up enabled	0x1	RW
[3:2]	SS_SLEW	00 01 10 11	SS/ADDR0 slew rate. Slowest Slow Fast Fastest	0x2	RW
[1:0]	SS_DRIVE	00 01 10 11	SS/ADDR0 drive strength. Lowest Low High Highest	0x0	RW

**MOSI/ADDR1 Pin Drive Strength and Slew Rate Register**

Address: 0xF79C, Reset: 0x0018, Name: MOSI\_ADDR1\_PIN

This register configures the drive strength, slew rate, and pull resistors for the MOSI/ADDR1 pin.

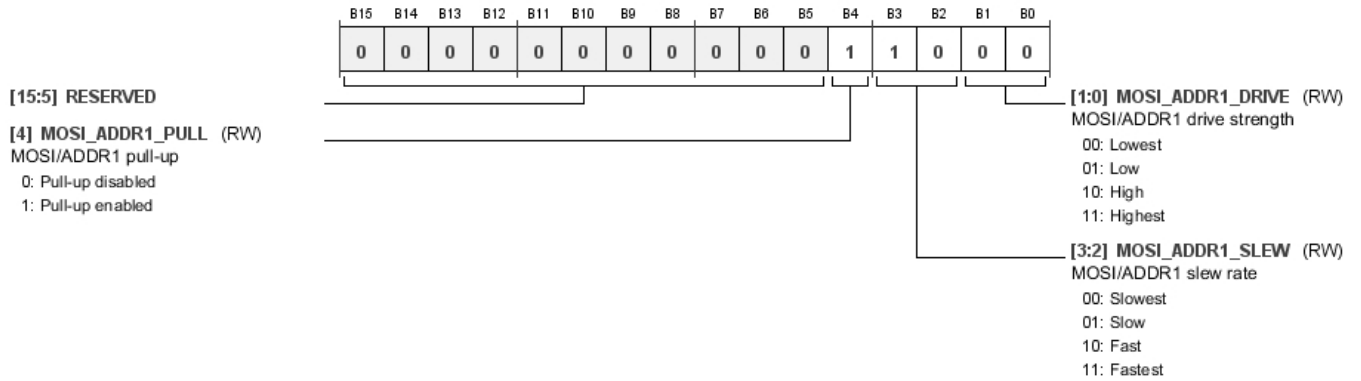

**Table 161. Bit Descriptions for MOSI\_ADDR1\_PIN**

Bits	Bit Name	Settings	Description	Reset	Access
[15:5]	RESERVED			0x0	RW
4	MOSI_ADDR1_PULL	0 1	MOSI/ADDR1 pull-up. Pull-up disabled Pull-up enabled	0x1	RW
[3:2]	MOSI_ADDR1_SLEW	00 01 10 11	MOSI/ADDR1 slew rate. Slowest Slow Fast Fastest	0x2	RW
[1:0]	MOSI_ADDR1_DRIVE	00 01 10 11	MOSI/ADDR1 drive strength. Lowest Low High Highest	0x0	RW

**SCL\_M/SCLK\_M/MP2 Pin Drive Strength and Slew Rate Register**

Address: 0xF79D, Reset: 0x0008, Name: SCLK\_SCL\_M\_PIN

This register configures the drive strength, slew rate, and pull resistors for the SCL\_M/SCLK\_M/MP2 pin.

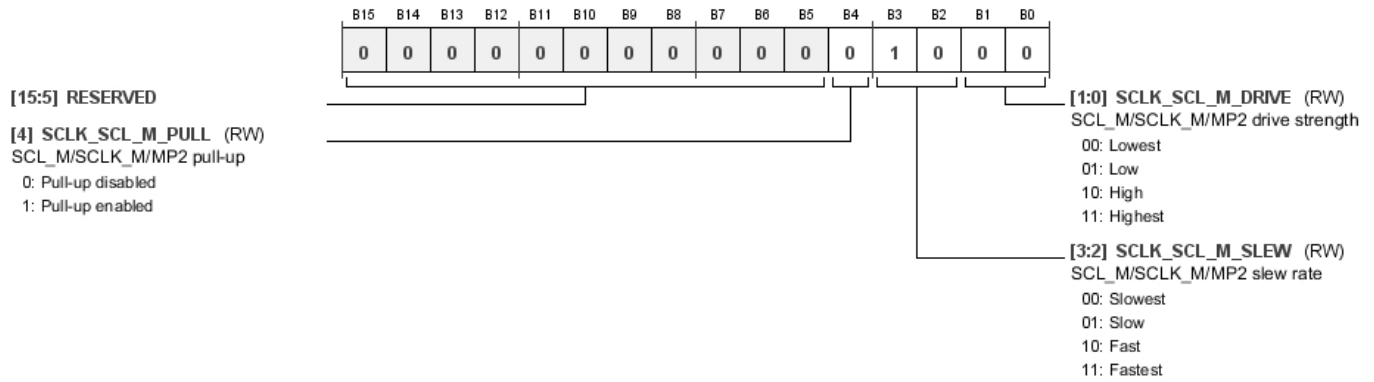

**Table 162. Bit Descriptions for SCLK\_SCL\_M\_PIN**

Bits	Bit Name	Settings	Description	Reset	Access
[15:5]	RESERVED			0x0	RW
4	SCLK_SCL_M_PULL	0 1	SCL_M/SCLK_M/MP2 pull-up. 0 Pull-up disabled 1 Pull-up enabled	0x0	RW
[3:2]	SCLK_SCL_M_SLEW	00 01 10 11	SCL_M/SCLK_M/MP2 slew rate. 00 Slowest 01 Slow 10 Fast 11 Fastest	0x2	RW
[1:0]	SCLK_SCL_M_DRIVE	00 01 10 11	SCL_M/SCLK_M/MP2 drive strength. 00 Lowest 01 Low 10 High 11 Highest	0x0	RW

**SDA\_M/MISO\_M/MP3 Pin Drive Strength and Slew Rate Register**

Address: 0xF79E, Reset: 0x0008, Name: MISO\_SDA\_M\_PIN

This register configures the drive strength, slew rate, and pull resistors for the SDA\_M/MISO\_M/MP3 pin.

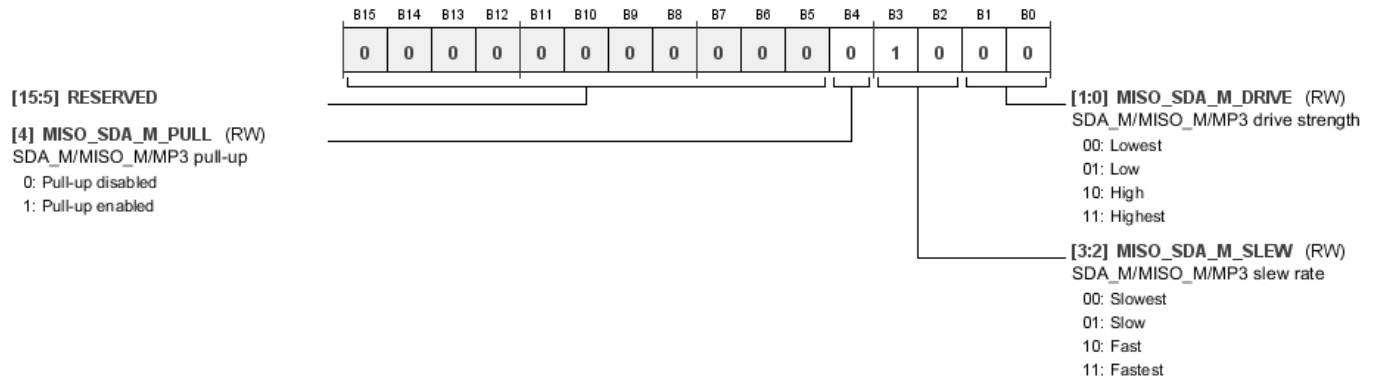

**Table 163. Bit Descriptions for MISO\_SDA\_M\_PIN**

Bits	Bit Name	Settings	Description	Reset	Access
[15:5]	RESERVED			0x0	RW
4	MISO_SDA_M_PULL	0 1	SDA_M/MISO_M/MP3 pull-up. Pull-up disabled Pull-up enabled	0x0	RW
[3:2]	MISO_SDA_M_SLEW	00 01 10 11	SDA_M/MISO_M/MP3 slew rate. Slowest Slow Fast Fastest	0x2	RW
[1:0]	MISO_SDA_M_DRIVE	00 01 10 11	SDA_M/MISO_M/MP3 drive strength. Lowest Low High Highest	0x0	RW

**SS\_M/MP0 Pin Drive Strength and Slew Rate Register**

Address: 0xF79F, Reset: 0x0018, Name: SS\_M\_PIN

This register configures the drive strength, slew rate, and pull resistors for the SS\_M/MP0 pin.

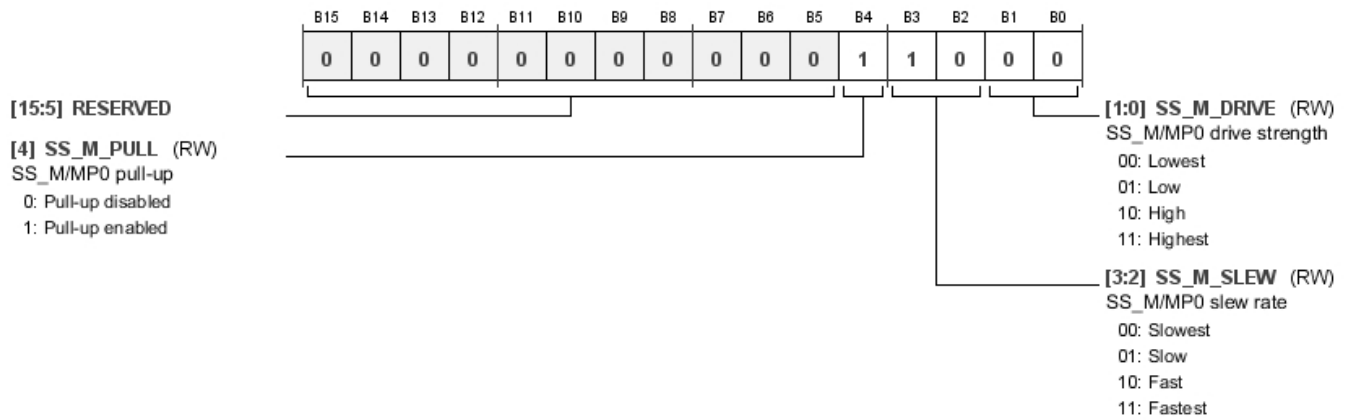

**Table 164. Bit Descriptions for SS\_M\_PIN**

Bits	Bit Name	Settings	Description	Reset	Access
[15:5]	RESERVED			0x0	RW
4	SS_M_PULL	0 1	SS_M/MP0 pull-up. Pull-up disabled Pull-up enabled	0x1	RW
[3:2]	SS_M_SLEW	00 01 10 11	SS_M/MP0 slew rate. Slowest Slow Fast Fastest	0x2	RW
[1:0]	SS_M_DRIVE	00 01 10 11	SS_M/MP0 drive strength. Lowest Low High Highest	0x0	RW

**MOSI\_M/MP1 Pin Drive Strength and Slew Rate Register**

Address: 0xF7A0, Reset: 0x0018, Name: MOSI\_M\_PIN

This register configures the drive strength, slew rate, and pull resistors for the MOSI\_M/MP1 pin.

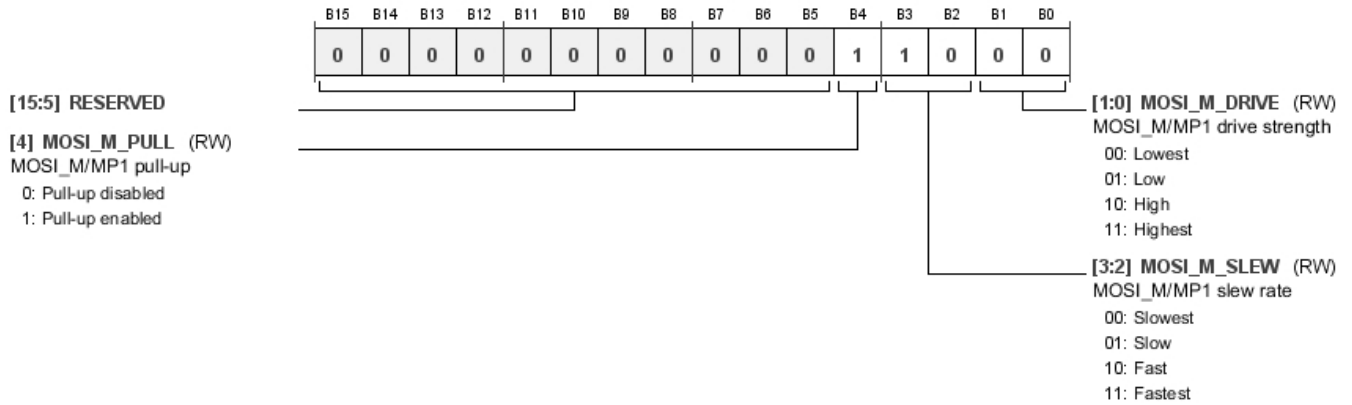

**Table 165. Bit Descriptions for MOSI\_M\_PIN**

Bits	Bit Name	Settings	Description	Reset	Access
[15:5]	RESERVED			0x0	RW
4	MOSI_M_PULL	0 1	MOSI_M/MP1 pull-up. 0 Pull-up disabled 1 Pull-up enabled	0x1	RW
[3:2]	MOSI_M_SLEW	00 01 10 11	MOSI_M/MP1 slew rate. 00 Slowest 01 Slow 10 Fast 11 Fastest	0x2	RW
[1:0]	MOSI_M_DRIVE	00 01 10 11	MOSI_M/MP1 drive strength. 00 Lowest 01 Low 10 High 11 Highest	0x0	RW

**MP6 Pin Drive Strength and Slew Rate Register**

Address: 0xF7A1, Reset: 0x0018, Name: MP6\_PIN

This register configures the drive strength, slew rate, and pull resistors for the MP6 pin.

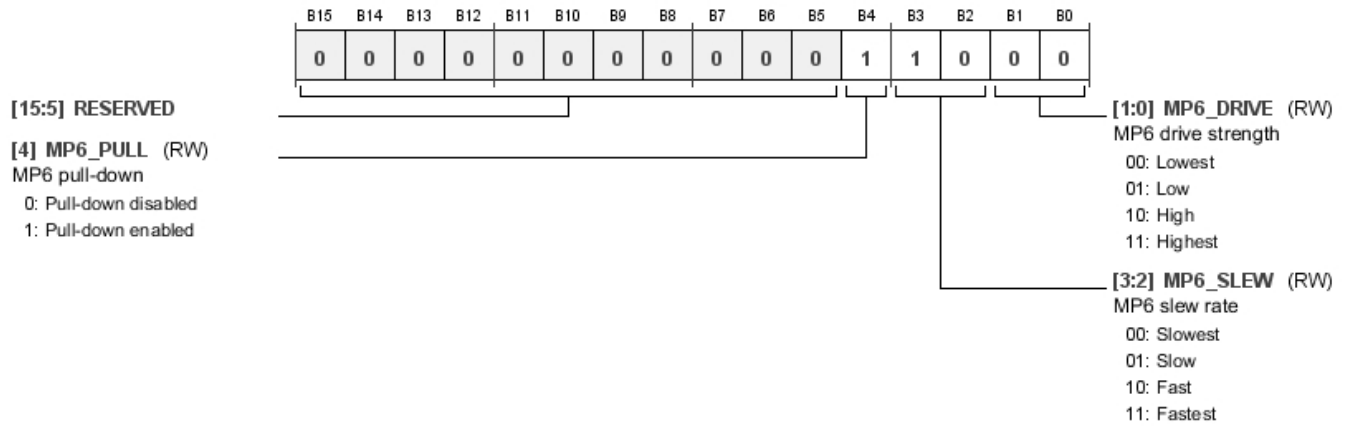

**Table 166. Bit Descriptions for MP6\_PIN**

Bits	Bit Name	Settings	Description	Reset	Access
[15:5]	RESERVED			0x0	RW
4	MP6_PULL	0 1	MP6 pull-down. Pull-down disabled Pull-down enabled	0x1	RW
[3:2]	MP6_SLEW	00 01 10 11	MP6 slew rate. Slowest Slow Fast Fastest	0x2	RW
[1:0]	MP6_DRIVE	00 01 10 11	MP6 drive strength. Lowest Low High Highest	0x0	RW



**MP7 Pin Drive Strength and Slew Rate Register**

Address: 0xF7A2, Reset: 0x0018, Name: MP7\_PIN

This register configures the drive strength, slew rate, and pull resistors for the MP7 pin.

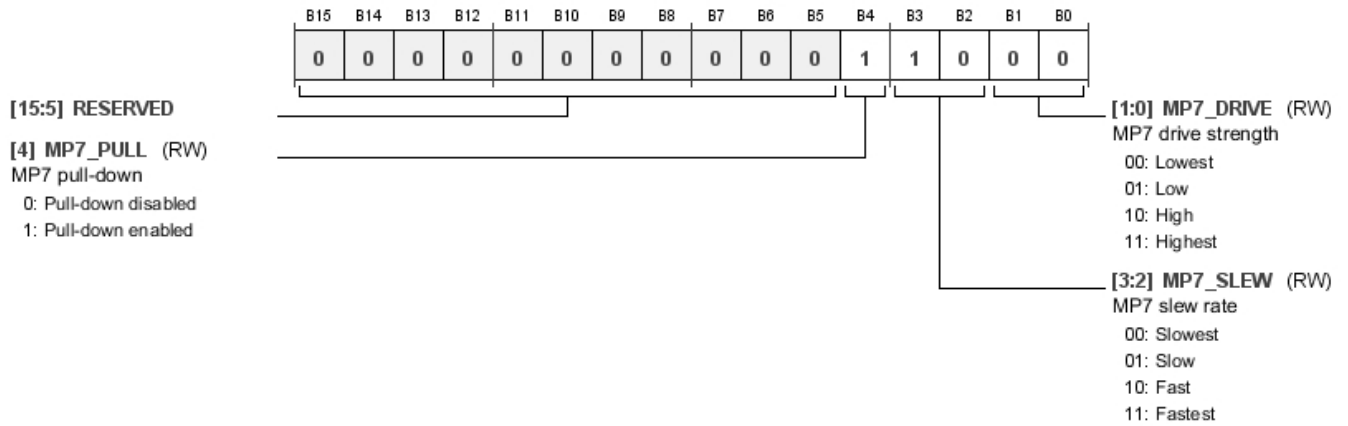

Table 167. Bit Descriptions for MP7\_PIN

Bits	Bit Name	Settings	Description	Reset	Access
[15:5]	RESERVED			0x0	RW
4	MP7_PULL	0 1	MP7 pull-down. 0 Pull-down disabled 1 Pull-down enabled	0x1	RW
[3:2]	MP7_SLEW	00 01 10 11	MP7 slew rate. 00 Slowest 01 Slow 10 Fast 11 Fastest	0x2	RW
[1:0]	MP7_DRIVE	00 01 10 11	MP7 drive strength. 00 Lowest 01 Low 10 High 11 Highest	0x0	RW

**CLKOUT Pin Drive Strength and Slew Rate Register**

Address: 0xF7A3, Reset: 0x0008, Name: CLKOUT\_PIN

This register configures the drive strength, slew rate, and pull resistors for the CLKOUT pin.

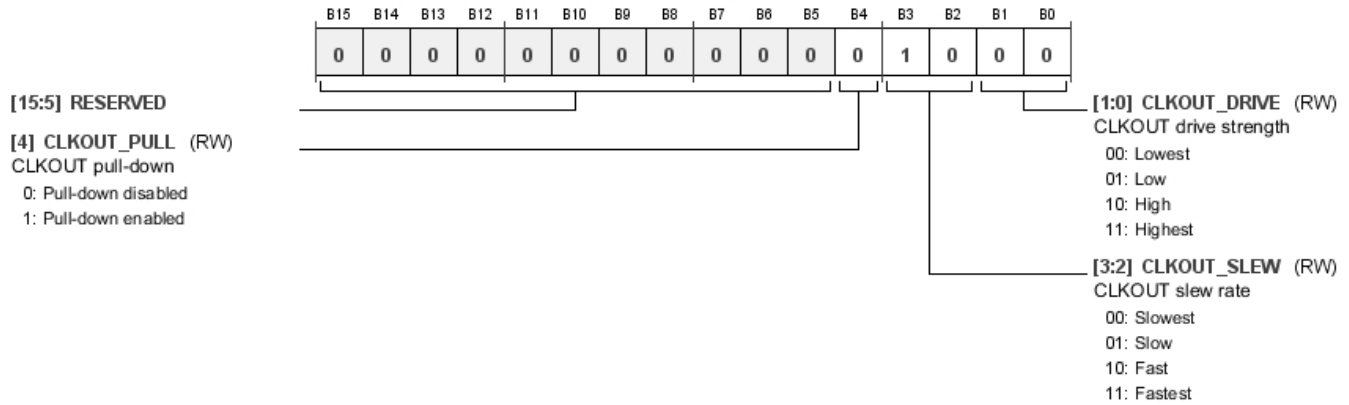

**Table 168. Bit Descriptions for CLKOUT\_PIN**

Bits	Bit Name	Settings	Description	Reset	Access
[15:5]	RESERVED			0x0	RW
4	CLKOUT_PULL	0 1	CLKOUT pull-down. Pull-down disabled Pull-down enabled	0x0	RW
[3:2]	CLKOUT_SLEW	00 01 10 11	CLKOUT slew rate. Slowest Slow Fast Fastest	0x2	RW
[1:0]	CLKOUT_DRIVE	00 01 10 11	CLKOUT drive strength. Lowest Low High Highest	0x0	RW

**SOFT RESET REGISTER**

**Address: 0xF890, Reset: 0x0001, Name: SOFT\_RESET**

SOFT\_RESET provides the capability to reset all control registers in the device or put it into a state similar to a hardware reset, where the RESET pin is pulled low to ground. All control registers are reset to their default values, except for the PLL registers: Register 0xF000 (PLL\_CTRL0), Register 0xF001 (PLL\_CTRL1), Register 0xF002 (PLL\_CLK\_SRC), Register 0xF003 (PLL\_ENABLE), Register 0xF004 (PLL\_LOCK), Register 0xF005 (MCLK\_OUT), and Register 0xF006 (PLL\_WATCHDOG), as well as registers related to the panic manager. The I<sup>2</sup>C and SPI slave ports remain operational, and the user can write new values to the PLL registers while the soft reset is active. If SPI slave mode is enabled, the device remains in SPI slave mode during and after the soft reset state. To reset the device to I<sup>2</sup>C slave mode, the device must undergo a hardware reset by pulling the RESET pin low to ground. Bit 0 (SOFT\_RESET) is active low, meaning that setting it to 0b1 enables normal operation and setting it to 0b0 enables the soft reset state.

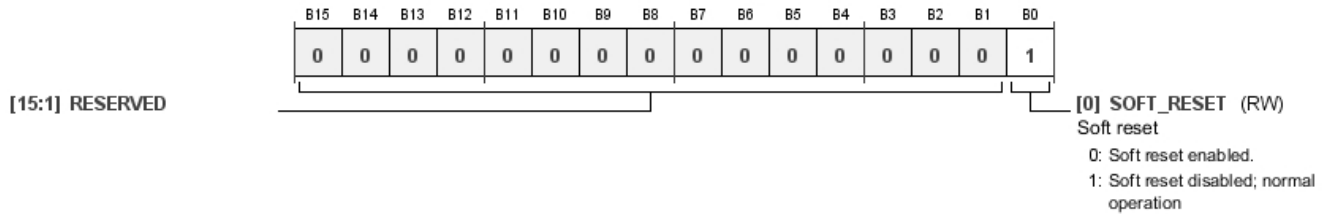

**Table 169. Bit Descriptions for SOFT\_RESET**

Bits	Bit Name	Settings	Description	Reset	Access
[15:1]	RESERVED			0x0	RW
0	SOFT_RESET	0 1	Soft reset. Soft reset enabled Soft reset disabled; normal operation	0x1	RW

## APPLICATIONS INFORMATION

### PCB DESIGN CONSIDERATIONS

A solid ground plane is a necessity for maintaining signal integrity and minimizing EMI radiation. If the PCB has two ground planes, they can be stitched together using vias that are spread evenly throughout the board.

#### Power Supply Bypass Capacitors

Bypass each power supply pin to its nearest appropriate ground pin with a single 100 nF capacitor and, optionally, with an additional 10 nF capacitor in parallel. Make the connections to each side of the capacitor as short as possible, and keep the trace on a single layer with no vias. For maximum effectiveness, place the capacitor either equidistant from the power and ground pins or, when equidistant placement is not possible, slightly nearer to the power pin (see Figure 81). Establish the thermal connections to the planes on the far side of the capacitor.

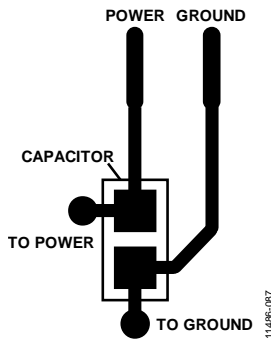

Figure 81. Recommended Power Supply Bypass Capacitor Layout

Typically, a single 100 nF capacitor for each power ground pin pair is sufficient. However, if there is excessive high frequency noise in the system, use an additional 10 nF capacitor in parallel (see Figure 82). In that case, place the 10 nF capacitor between the devices and the 100 nF capacitor, and establish the thermal connections on the far side of the 100 nF capacitor.

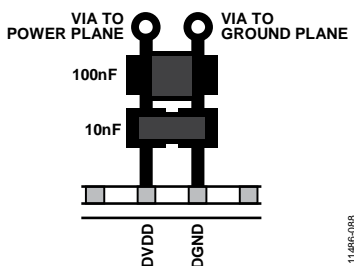

Figure 82. Layout for Multiple Power Supply Bypass Capacitors

To provide a current reservoir in case of sudden current spikes, use a 10 μF capacitor for each named supply (DVDD, AVDD, PVDD, and IOVDD) as shown in Figure 83.

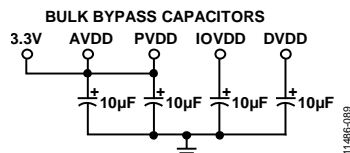

Figure 83. Bulk Capacitor Schematic

#### Parts Placement

Place all 100 nF bypass capacitors, which are recommended for every analog, digital, and PLL power ground pair, as near as possible to the ADAU1452/ADAU1451/ADAU1450. Bypass each of the AVDD, DVDD, PVDD, and IOVDD supply signals on the board with an additional single bulk capacitor (10 μF to 47 μF).

Keep all traces in the crystal resonator circuit (see Figure 15) as short as possible to minimize stray capacitance. Do not connect any long board traces to the crystal oscillator circuit components because such traces may affect crystal startup and operation.

#### Grounding

Use a single ground plane in the application layout. Place all components in an analog signal path away from digital signals.

#### Exposed Pad PCB Design

The device package includes an exposed pad for improved heat dissipation. When designing a board for such a package, give special consideration to the following:

- Place a copper layer, equal in size to the exposed pad, on all layers of the board, from top to bottom. Connect the copper layers to a dedicated copper board layer (see Figure 84).

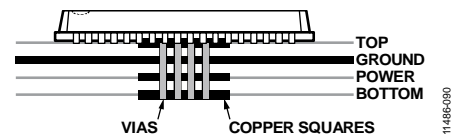

Figure 84. Exposed Pad Layout Example—Side View

- Place vias such that all layers of copper are connected, allowing for efficient heat and energy conductivity. For an example, see Figure 85, which shows 49 vias arranged in a 7 × 7 grid in the pad area.

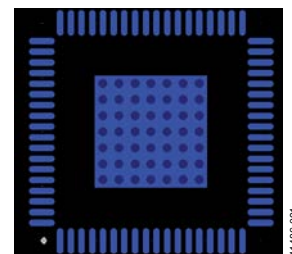

Figure 85. Exposed Pad Layout Example—Top View

#### PLL Filter

To minimize jitter, connect the single resistor and two capacitors in the PLL filter to the PLLFILT and PVDD pins with short traces.

**Power Supply Isolation with Ferrite Beads**

Ferrite beads can be used for supply isolation. When using ferrite beads, always place the beads outside the local high frequency decoupling capacitors, as shown in Figure 86. If the ferrite beads are placed between the supply pin and the decoupling capacitor, high frequency noise is reflected back into the IC because there is no suitable return path to ground. As a result, EMI increases, creating noisy supplies.

**EOS/ESD Protection**

Although the ADAU1452/ADAU1451/ADAU1450 has robust internal protection circuitry against overvoltages and electrostatic discharge, an external transient voltage suppressor (TVS) is recommended for all systems to prevent damage to the IC. For examples, see the AN-311 Application Note.

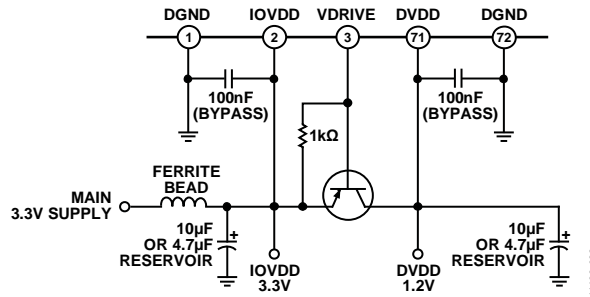

Figure 86. Ferrite Bead Power Supply Isolation Circuit Example

**TYPICAL APPLICATIONS BLOCK DIAGRAM**

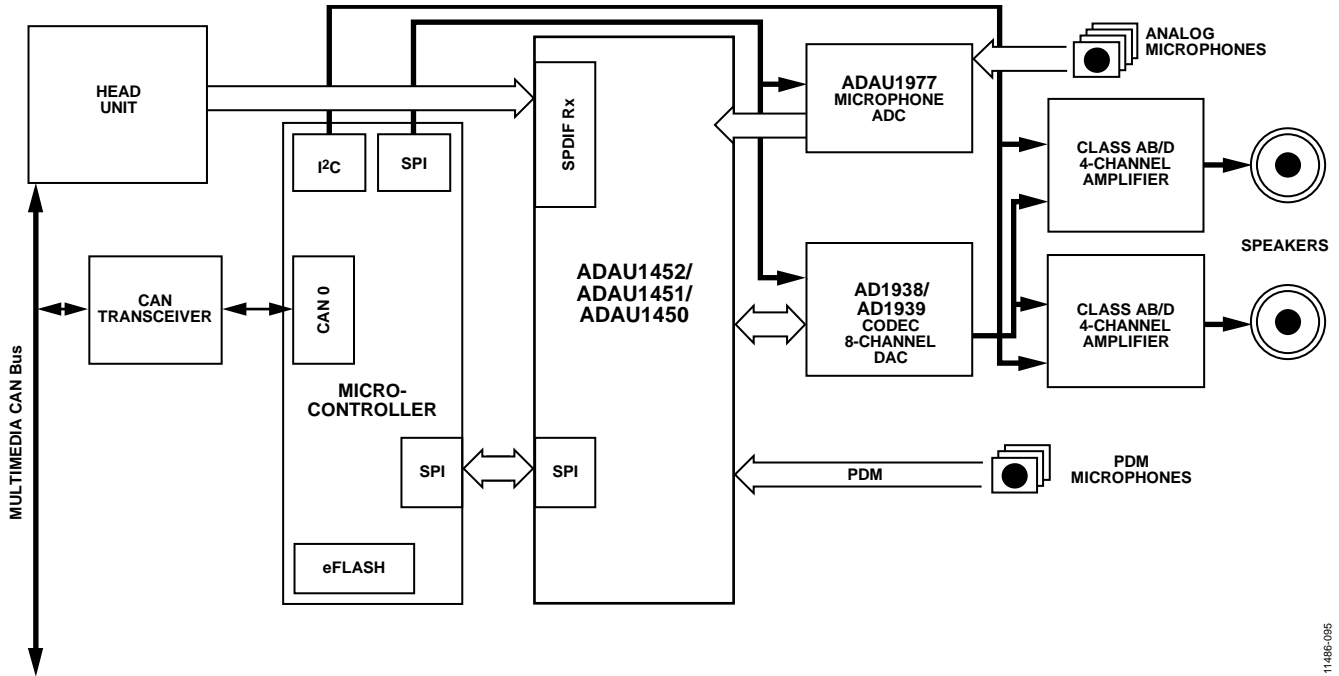

Figure 87. Automotive Infotainment Amplifier Block Diagram

**EXAMPLE PCB LAYOUT**

Several external components, such as capacitors, resistors, and a transistor, are required for proper operation of the device. An example of the connection and layout of these components is shown in Figure 88. Thick black lines represent traces, gray rectangles represent components, and white circles with a thick black ring represent thermal via connections to power or ground planes. If a 1.2 V supply is available in the system, the transistor circuit (including the associated 1 kΩ resistor) can be removed, and 1.2 V can be connected directly to the DVDD power net, with the VDRIVE pin left floating.

The analog (AVDD), PLL (PVDD), and interface (IOVDD) supply pins each have local 100 nF bypass capacitors to provide high frequency return currents with a short path to ground.

The digital (DVDD) supply pins each have up to three local bypass capacitors, as follows:

- The 10 nF bypass capacitor, placed closest to the pin, acts as a return path for very high frequency currents resulting from the nominal 294 MHz operating frequency of the DSP core.
- The 100 nF bypass capacitor acts as a return path for high frequency currents from the DSP and other digital circuitry.
- The 1 μF bypass capacitor is required to provide a local current supply for sudden spikes in current that occur at the beginning of each audio frame when the DSP core switches from idle mode to operating mode.

Of these three bypass capacitors, the most important is the 100 nF bypass capacitor, which is required for proper power supply bypassing. The 10 nF and 1 μF capacitors can optionally be used to improve the EMI/EMC performance of the system.

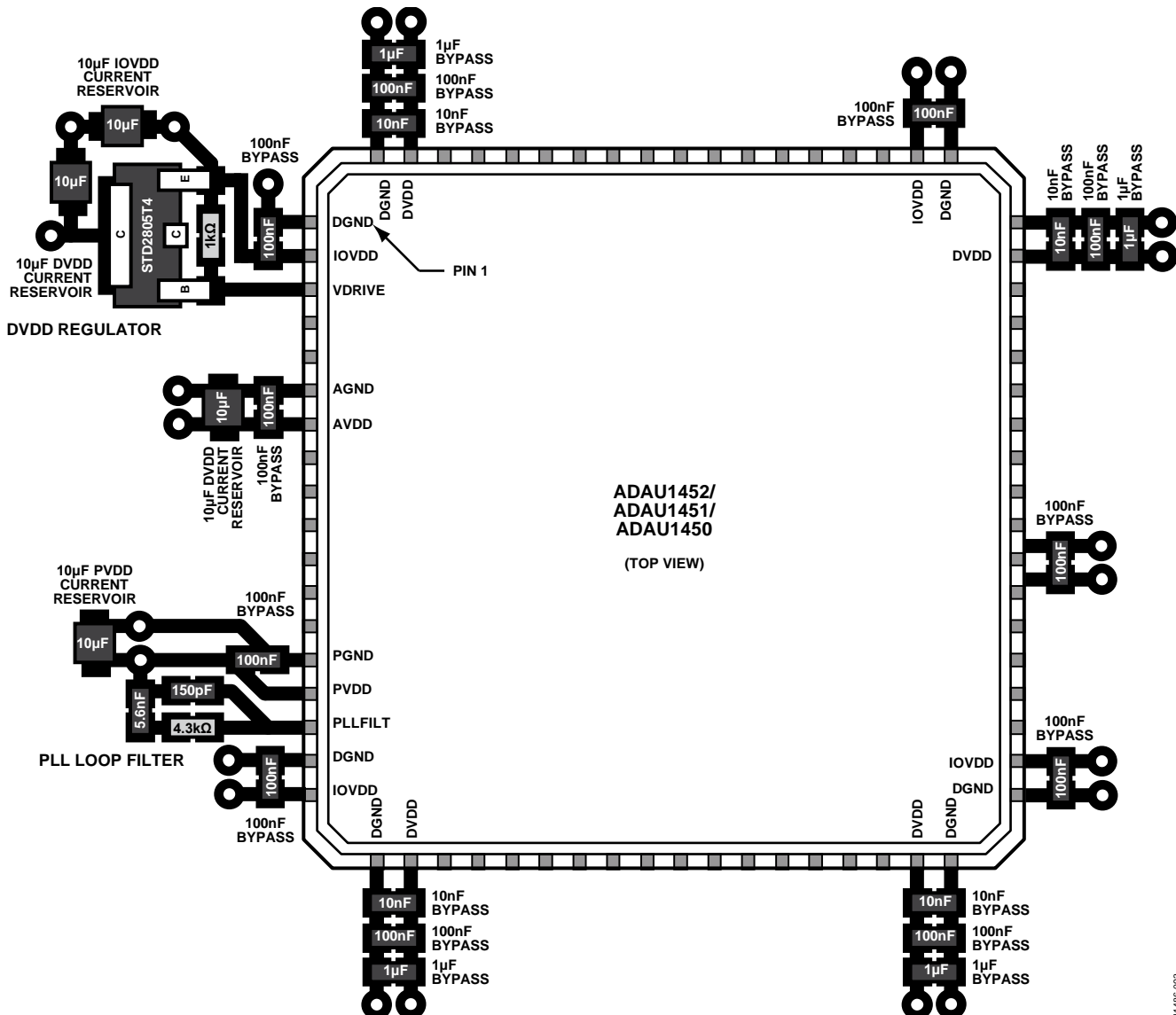

Figure 88. Supporting Component Placement and Layout

11486-003

**PCB MANUFACTURING GUIDELINES**

The soldering profile in Figure 89 is recommended for the LFCSP package. See the [AN-772 Application Note](#) for more information about PCB manufacturing guidelines.

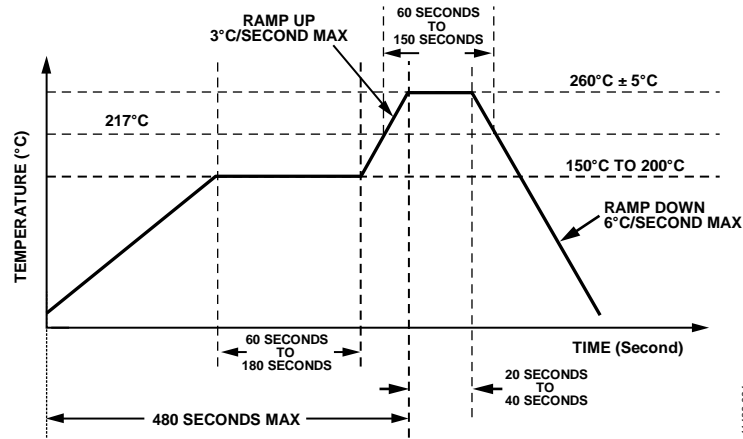

Figure 89. Soldering Profile

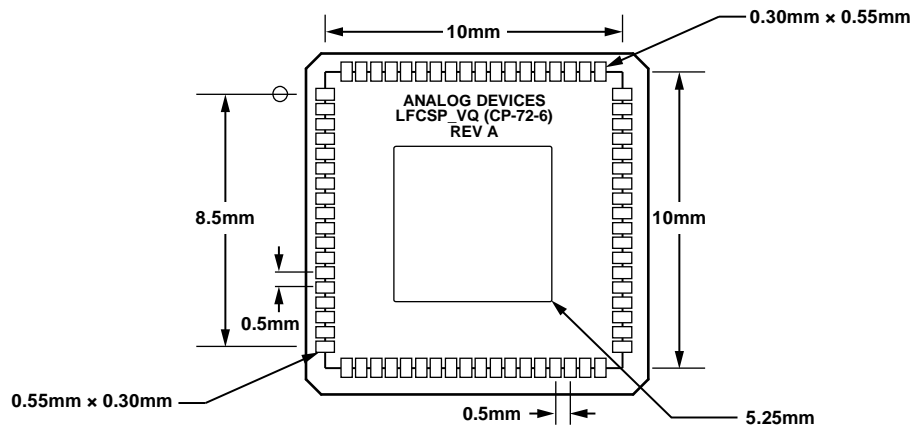
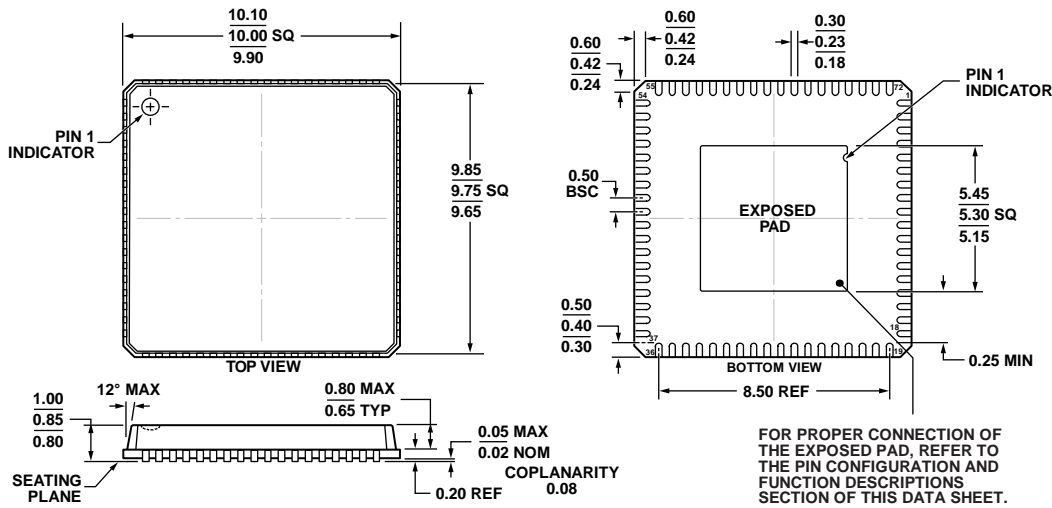

Figure 90. PCB Decal Dimensions

OUTLINE DIMENSIONS



COMPLIANT TO JEDEC STANDARDS MO-220-VNND-4

Figure 91. 72-Lead Lead Frame Chip Scale Package [LFCSP\_VQ]  
 10 mm × 10 mm Body, Very Thin Quad  
 (CP-72-6)  
 Dimensions shown in millimeters

ORDERING GUIDE

Model <sup>1,2</sup>	Temperature Range	Package Description	Package Option
ADAU1452WBCPZ	-40°C to +105°C	72-Lead Lead Frame Chip Scale Package [LFCSP_VQ]	CP-72-6
ADAU1452WBCPZ-RL	-40°C to +105°C	72-Lead Lead Frame Chip Scale Package [LFCSP_VQ], 13" Tape and Reel	CP-72-6
ADAU1451WBCPZ	-40°C to +105°C	72-Lead Lead Frame Chip Scale Package [LFCSP_VQ]	CP-72-6
ADAU1451WBCPZ-RL	-40°C to +105°C	72-Lead Lead Frame Chip Scale Package [LFCSP_VQ], 13" Tape and Reel	CP-72-6
ADAU1450WBCPZ	-40°C to +105°C	72-Lead Lead Frame Chip Scale Package [LFCSP_VQ]	CP-72-6
ADAU1450WBCPZ-RL	-40°C to +105°C	72-Lead Lead Frame Chip Scale Package [LFCSP_VQ], 13" Tape and Reel	CP-72-6
EVAL-ADAU1452Z		Evaluation Board	
EVAL-ADAU1452MINIZ		Evaluation Board	

<sup>1</sup> Z = RoHS compliant part.  
<sup>2</sup> W = Qualified for Automotive Applications.

AUTOMOTIVE PRODUCTS

The ADAU1452W/ADAU1451W/ADAU1450W models are available with controlled manufacturing to support the quality and reliability requirements of automotive applications. Note that these automotive models may have specifications that differ from the commercial models; therefore, designers should review the Specifications section of this data sheet carefully. Only the automotive grade products shown are available for use in automotive applications. Contact your local Analog Devices account representative for specific product ordering information and to obtain the specific Automotive Reliability reports for these models.

<sup>1</sup>C refers to a communications protocol originally developed by Philips Semiconductors (now NXP Semiconductors).