

**PLEASE CHECK WWW.MOLEX.COM FOR LATEST PART INFORMATION**

**Part Number:** [63891-1000](#)  
**Status:** **Active**  
**Description:** Mini-Mac™ Applicator

**Documents:**

[RoHS Certificate of Compliance \(PDF\)](#)

**General**

Product Family	Application Tooling
Series	T9999
Comments	See Tooling Specification (PDF) Above
Function	Crimp
Geographic Area	Global
Level of Automation	Automatic, Semi-Automatic
More Detailed Tech Information	<a href="mailto:applicationtooling@molex.com">applicationtooling@molex.com</a>
Product Name	Mini-Mac™
Survey	<a href="http://www.molex.com//review/apptool_survey.html">www.molex.com//review/apptool_survey.html</a>
Tool Type	Mini-Mac Applicator
UPC	800756654157

**Physical**

Net Weight 4950.616/g

**Material Info**

**Reference - Drawing Numbers**

Application Tooling Documents

ATS-638911000, TM-638000029, TM-638000029CN, TM-638000029DE, TM-638000029FR, TM-638000029IT, TM-638000029JP, TM-638000029KR, TM-638000029MY, TM-638000029PL, TM-638000029RU, TM-638000029SK, TM-638000029SP, TM-638000029TH, TM-638000029TW, TM-638000029VN, TM-638000100, TM-638000100SP

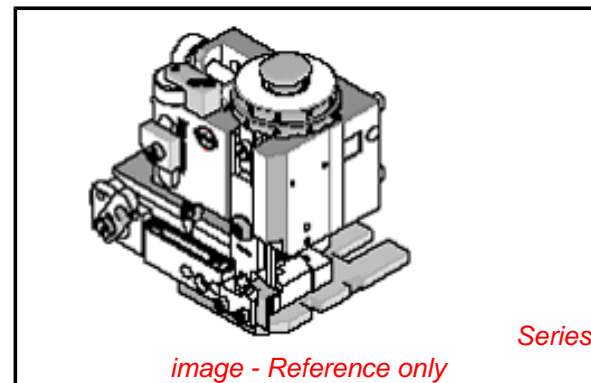

**EU RoHS**

**ELV and RoHS Compliant**

**REACH SVHC**

Not Reviewed

**Low-Halogen Status**

Not Reviewed

**China RoHS**



**Need more information on product environmental compliance?**

Email [productcompliance@molex.com](mailto:productcompliance@molex.com)  
 For a multiple part number RoHS Certificate of Compliance, [click here](#)

Please visit the [Contact Us](#) section for any non-product compliance questions.

**Search Parts in this Series**

[T9999Series](#)

**Use With**

Molex TM-3000™: [63801-7200](#) , [63801-7300](#) , Molex TM-4000™: [63801-7600](#) , Molex TM-2000™: [63800-8300](#) , [63800-8400](#) , and Most Industry Standard Presses or Wire Process Machines