



Features

- Frequency Range 50MHz to 4000MHz
- 7-Bit, 31.75dB Range, 0.25dB Step
- High Linearity, IP3 >50dBm
- 3V and 5V Logic Compatible
- On-chip Parallel Decoder
- Parallel Programming Interface
- On-chip ESD Protection >500V HBM
- Single Supply, 3V to 5V Operation

Applications

- Transceiver IF Applications
- Cellular, PCS, GSM, UMTS, LTE,
- WiMax/WiFi
- Wireless Data, Satellite Terminals
- Test Equipment

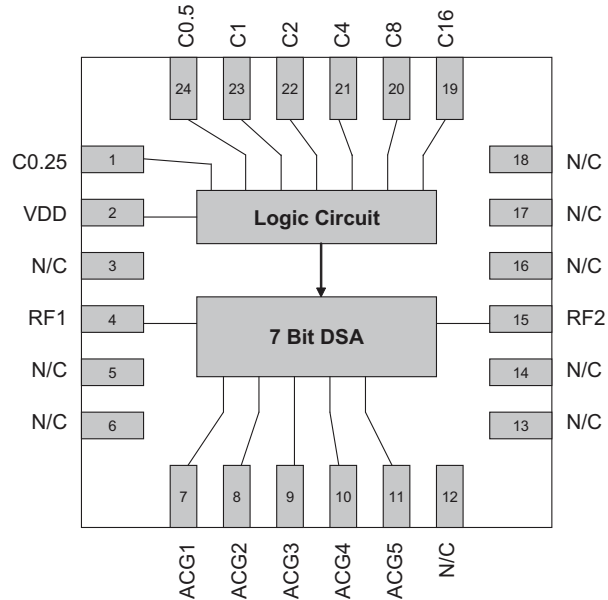

Functional Block Diagram

Product Description

RFMD's RFSA2714 is a 7-bit digital step attenuator (DSA) that features high linearity over the entire 31.75dB gain control range with excellent step accuracy in 0.25dB steps. The parallel-controlled RFSA2714 has an on-chip decoder that is both 3V and 5V compatible. The RFSA2714 also offers a rugged Class 1B HBM ESD rating via on-chip ESD circuitry.

Ordering Information

RFSA2714SR	7" Sample reel with 100 pieces
RFSA2714SQ	Sample bag with 25 pieces
RFSA2714TR13	13" Reel with 2500 pieces
RFSA2714PCK-410	50MHz to 4GHz PCBA with 5-piece sample bag

Absolute Maximum Ratings

Parameter	Rating	Unit
Supply Voltage	+5.5	V
DC Supply Current	15	mA
Power Dissipation	83	mW
Max RF Input Power	27	dBm
Operating Temperature (T _{CASE})	-40 to +85	°C
Storage Temperature	-40 to +150	°C
Junction Temperature	150	°C
ESD Rating (HBM)	Class 1B	
Moisture Sensitivity Level	MSL1	



Caution! ESD sensitive device.

Exceeding any one or a combination of the Absolute Maximum Rating conditions may cause permanent damage to the device. Extended application of Absolute Maximum Rating conditions to the device may reduce device reliability. Specified typical performance or functional operation of the device under Absolute Maximum Rating conditions is not implied.

The information in this publication is believed to be accurate and reliable. However, no responsibility is assumed by RF Micro Devices, Inc. ("RFMD") for its use, nor for any infringement of patents, or other rights of third parties, resulting from its use. No license is granted by implication or otherwise under any patent or patent rights of RFMD. RFMD reserves the right to change component circuitry, recommended application circuitry and specifications at any time without prior notice.

Parameter	Specification			Unit	Condition
	Min.	Typ.	Max.		
Frequency Range	50		4000	MHz	
Insertion Loss		0.85		dB	150MHz, 0dB attenuation
		1.1		dB	850MHz, 0dB attenuation
		1.7		dB	2700MHz, 0dB attenuation
		2.1		dB	3800MHz, 0dB attenuation
Gain Control Range		31.75		dB	0.25dB step size
Step Accuracy	±(0.1 + 5% attenuation setting)			dB	
Input IP3		50		dBm	100MHz to 4000MHz
Input P0.1dB		25		dBm	1000MHz
Return Loss		15		dB	DC to 3000MHz, all states
Control Interface		7-bit, Parallel			Parallel Interface
Settling Time		200		ns	t _{RISE} , t _{FALL} (10%/90% RF)
Switching Speed		200		ns	t _{ON} , t _{OFF} (50% CTL to 10%/90% RF)
Supply Voltage (V _{DD})	4.75	5.0	5.25	V	
Supply Current		7.5		mA	
Control Voltage (V _{CTL})	Low, V _{CTL} = 0 to 0.8			V	
	High, V _{CTL} = 2.0 to V _{DD}				

Notes:

- V_{DD} = 5V, V_{CTL} = 5V, T = 25 °C.
- Broadband Application Circuit (with ACG caps).
- IIP3 measured with P_{IN} = +10dBm/tone, 1MHz spacing.

Typical Performance: Broadband Application Circuit (25 °C)

DSA 0dB State Insertion Loss (dB)

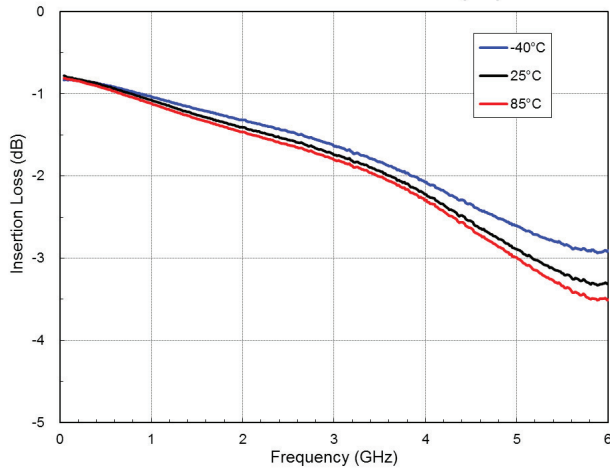

Normalized Attenuation (dB)

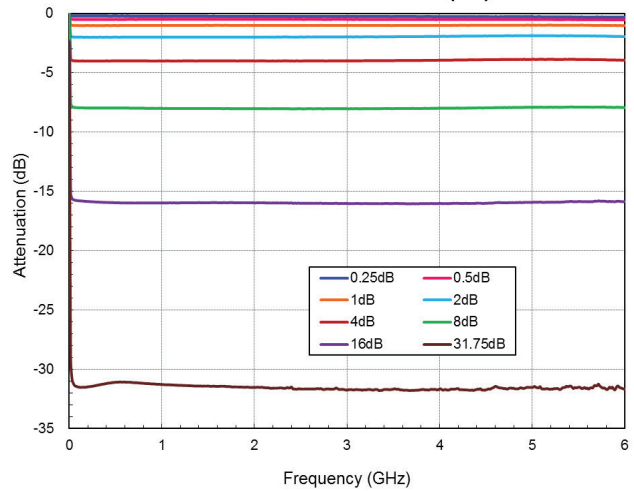

DSA Major Step Error (dB)

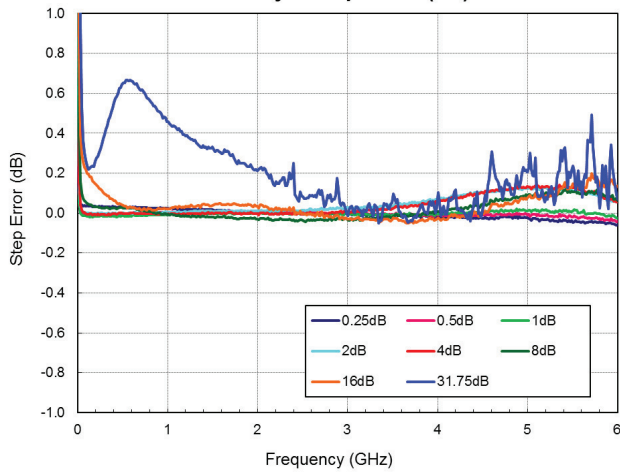

Step Error (dB)

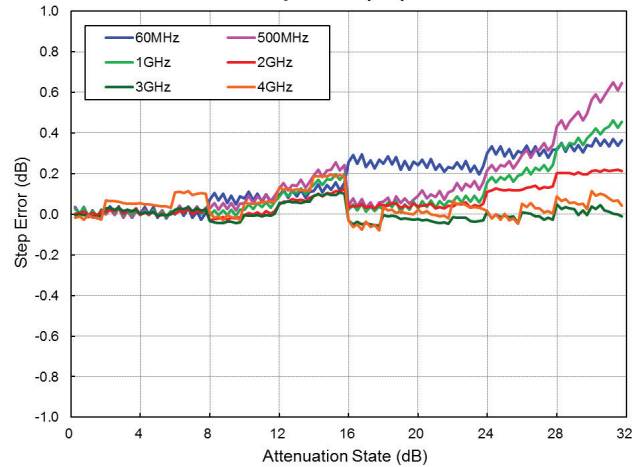

Input Return Loss (dB)

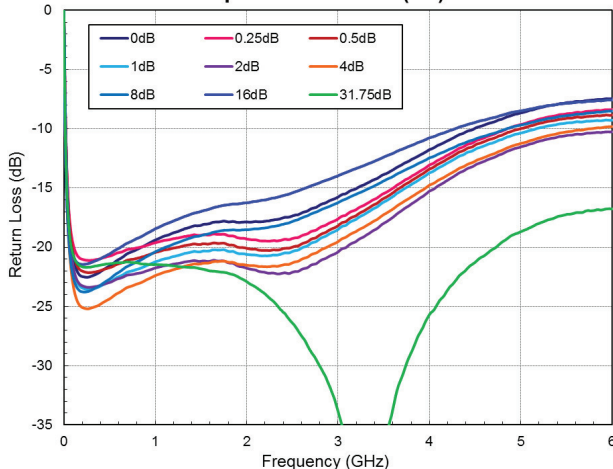

Output Return Loss (dB)

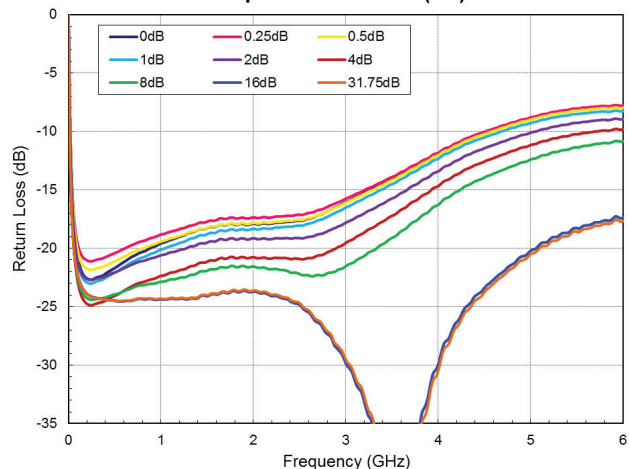

Typical Performance: Broadband Application Circuit (25 °C)

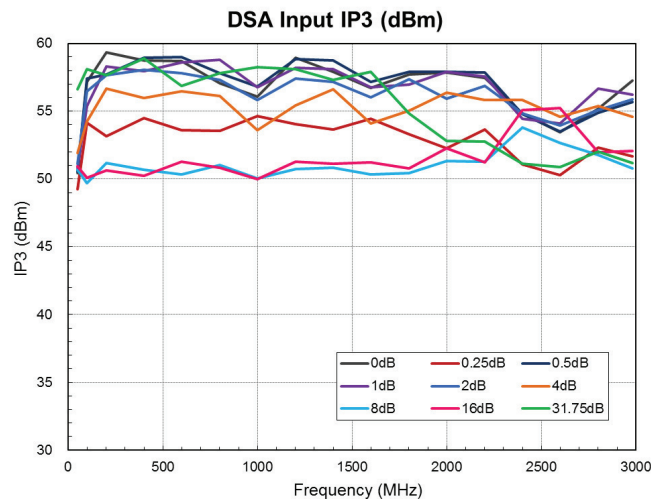
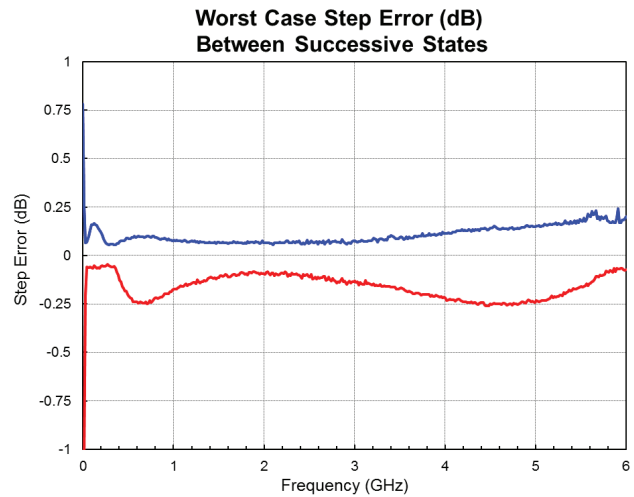
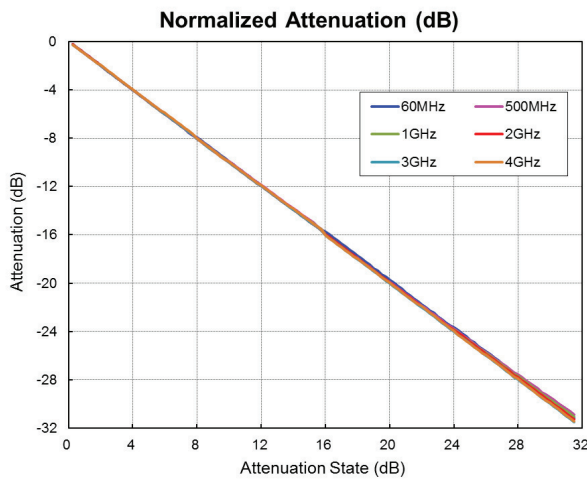
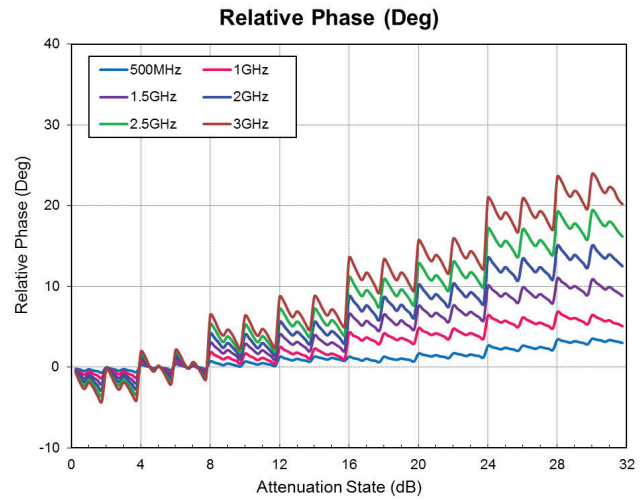
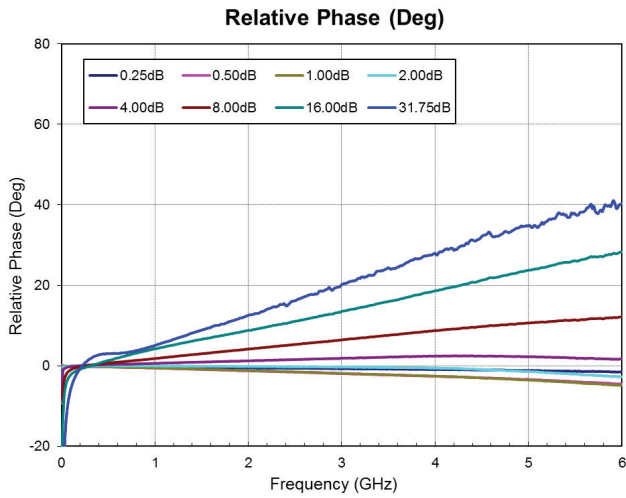

Truth Table

Control Bit							Relative Gain Setting
C16	C8	C4	C2	C1	C0.5	C0.25	
1	1	1	1	1	1	1	Max gain
1	1	1	1	1	1	0	-0.25dB
1	1	1	1	1	0	1	-0.5dB
1	1	1	1	0	1	1	-1dB
1	1	1	0	1	1	1	-2dB
1	1	0	1	1	1	1	-4dB
1	0	1	1	1	1	1	-8dB
0	1	1	1	1	1	1	-16dB
0	0	0	0	0	0	0	-31.75dB

Note: C0.25 = D0, C0.5 = D1, ..., C16 = D6 (for the purpose of the example below)

Logic Voltage Levels	
State	Logic
Low	0V to 0.8V
High	2.0V to 5.0V

Pin Names and Description

Pin	Name	Description
1	C0.25	0.25dB Control Bit.
2	VDD	Power Supply.
3	NC	No Internal Connection. EVB can be ground or no connect.
4	RF1	RF Port. External DC Block Required.
5	NC	No Internal Connection. EVB can be ground or no connect.
6	NC	No Internal Connection. EVB can be ground or no connect.
7	ACG	AC Ground Connection for Operation below 500MHz.
8	ACG	AC Ground Connection for Operation below 500MHz.
9	ACG	AC Ground Connection for Operation below 500MHz.
10	ACG	AC Ground Connection for Operation below 500MHz.
11	ACG	AC Ground Connection for Operation below 500MHz.
12	NC	No Internal Connection. EVB can be ground or no connect.
13	NC	No Internal Connection. EVB can be ground or no connect.
14	NC	No Internal Connection. EVB can be ground or no connect.
15	RF2	RF Port. External DC Block Required.
16	NC	No Internal Connection. EVB can be ground or no connect.
17	NC	No Internal Connection. EVB can be ground or no connect.
18	NC	No Internal Connection. EVB can be ground or no connect.
19	C16	16dB Control Bit.
20	C8	8dB Control Bit.
21	C4	4dB Control Bit.
22	C2	2dB Control Bit.
23	C1	1dB Control Bit.
24	C0.5	0.5dB Control Bit.
EPAD	GND	DC and RF Ground. Must be soldered to EVB ground plane over a bed of vias for thermal and RF performance.

Evaluation Board Assembly Drawing

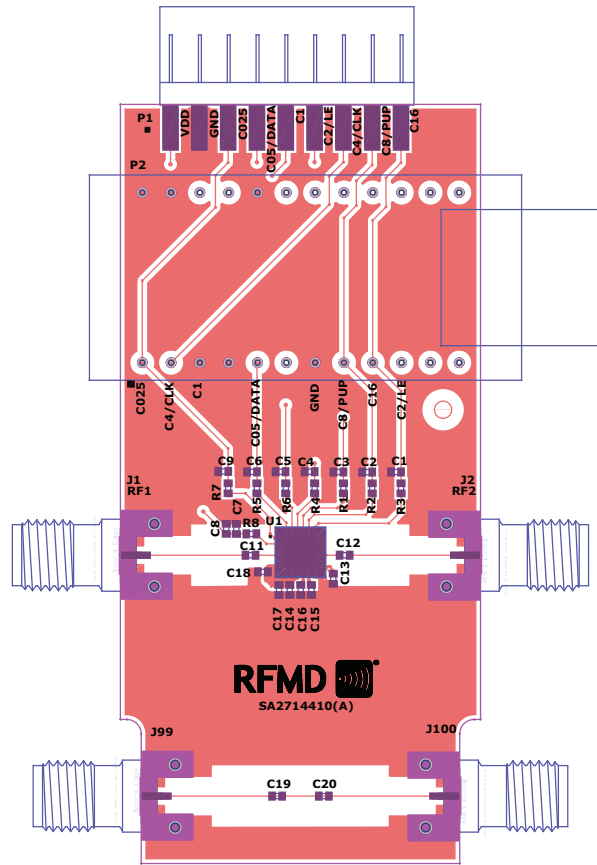

Evaluation Board Schematic

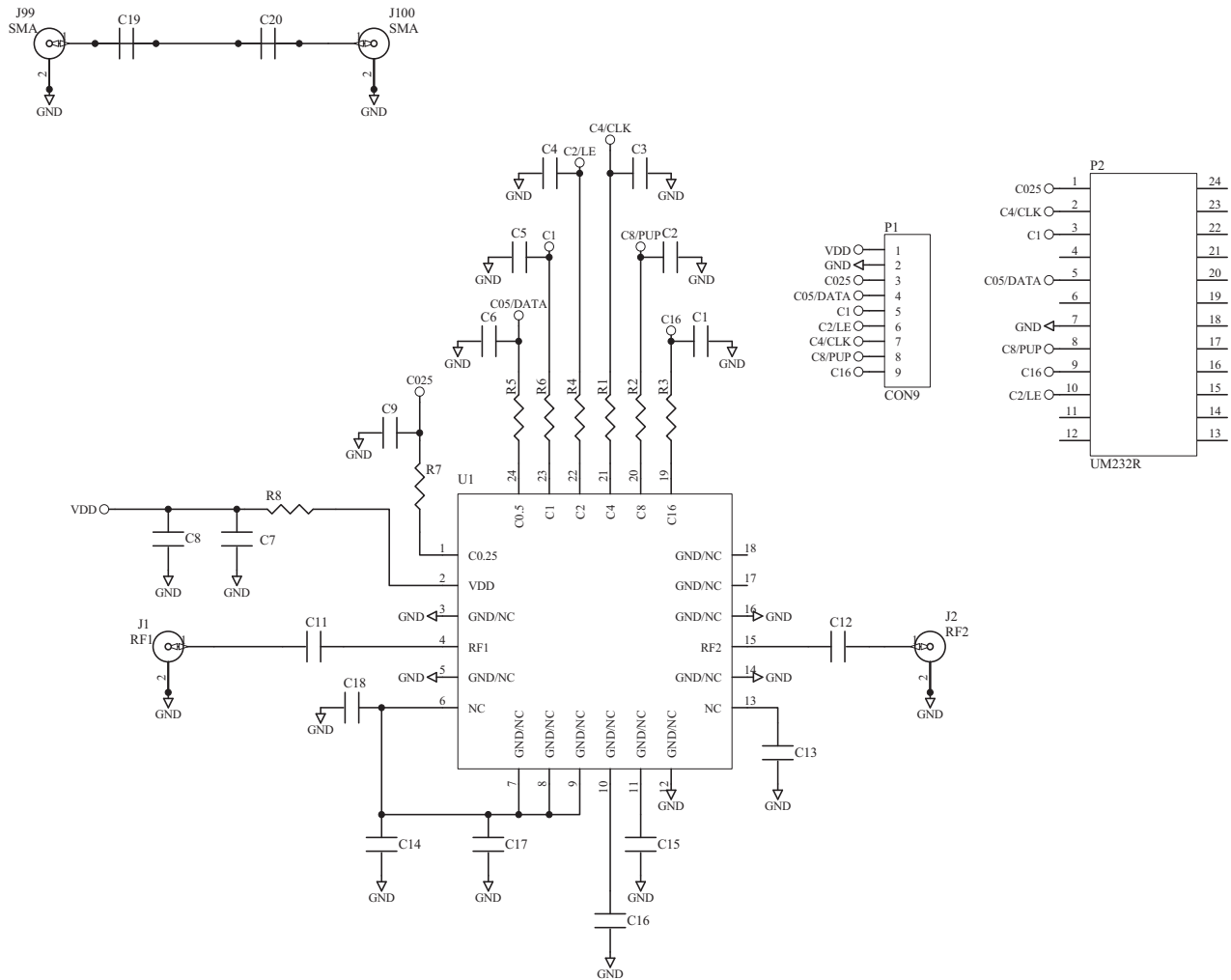

Evaluation Board Bill of Materials (BOM)

Description	Reference Designator	Manufacturer	Manufacturer's P/N
SA2714410(A)		Dynamic Details (DDI) Toronto	SA2714410(A)
Digital Step Attenuator 50MHz to 4000MHz	U1	RFMD	RFSA2714SB
CAP, 1000pF, 10%, 50V, X7R, 0402	C7	Taiyo Yuden (USA), Inc.	RM UMK105BJ102KV-F
CAP, 470pF, 10%, 50V, X7R, 0402	C11-C12	Murata Electronics	GRM155R71H471KA01E
CAP, 680pF, 5%, 50V, C0G, 0402	C14, C15, C16	Murata Electronics	GRM1555C1H681JA01D
RES, 0Ω, 0402	R1-R8	Kamaya, Inc	RMC1/16SJPTH
CONN, SMA, END LNCH, UNIV, HYB MNT, FLT	J1-J2, J99-J100	Molex	SD-73251-4000
CONN, HDR, ST, PLRZD, 9-PIN	P1	ITW Pancon	MPSS100-9-C
CONN, SKT, 24-PIN DIP, .600", T/H	P2	Aries Electronics Inc.	24-6518-10
MOD, USB TO SERIAL UART, SSOP-28	M1 (See Note Below)	Future Technology Devices Int'l	UM232R
DNP	C1-C6, C8-C9, C13, C17-C20	NA	NA

Note: M1 should be mounted into P2 with respect to the Pin 1 alignment of M1 and P2

Branding Drawing

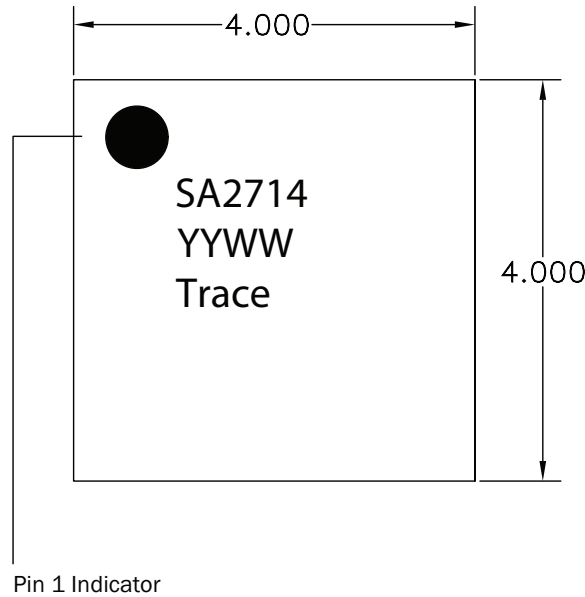

Fill in the YYWW Notation with the Date Code

YY = Year

WW = Week

Trace to be assigned by SubCon

Package Drawing

