



*TENTATIVE*

# LED DOT MATRIX MODULE

MODEL : KLM-128D CAN

광전자 주식회사  
AUK CORP.

802- 12 Shinheung-Dong, Iksan, Korea TEL : (063) 835-7111  
FAX : (063) 835-2681

URL : <http://www.auk.co.kr>  
E-mail : [webmaster@auk.co.kr](mailto:webmaster@auk.co.kr)

## 1. OVERVIEW

AUK has successfully developed a 16\*32 LED dot matrix module.

It is integrated with Chip LED lamps. This module is compact, slim and light.

It is suitable for the wide applications of a graphic & video board beyond a simple message board.

## 2. SPECIFICATION

ITEM	DESCRIPTION
Size( W×H×D)	128×256×11(mm)
Display Color	Red, Green, Amber, Black
Number of Dots	512(16×32)
Drive mode	Dynamic Drive(1/16 Duty)
Brightness Control	Red : 10 steps, Green : 10 steps(Total Brightness)
Over Voltage Protection	Works at over 6V (Only LED Off)
Viewing Angle	Horizontal : ±60°, Vertical ±75°
Weight	213±5g

## 3. ELECTRICAL CHARACTERISTICS

### 1) ABSOLUTE MAXIMUM RATINGS(Ta=25℃)

ITEM	SYMBOL	RATING	UNIT	
DC Supply Voltage	Circuit	Vcc1	6	V
	LED	Vcc2	5.25	V
Input Voltage	Circuit	Vin1	-0.3 to Vcc1 +0.3	V
	LED	Vin2	-0.3 to Vcc2	V
Current Consumption	Circuit	IC	0.2(Vcc=5V)	A
	LED	IL	3.8(Vcc=5V)	A
Clock Frequency	f	50	MHz	
Operating Temperature	Topr	-25 ~ 45	℃	
Storage Temperature	Tstg	-25 ~ 85	℃	
Isolation Temperature	Viso	AC500V(10mA), 1Minute(connector ~ supporter)		

### 2) RECOMMENDABLE DRIVE CONDITIONS

ITEM	SYMBOL	RATING	UNIT	
DC Supply Voltage	Circuit	Vcc1	4.75 ~ 5.25	V
	LED	Vcc2	4.75 ~ 5.25	V
Operating Temperature	Topr	0 ~ 40	℃	

#### 4. OPTICAL CHARACTERISTIC

◆ MEASURE AREA :  $\Phi 127\text{mm}$   
(Note 1)

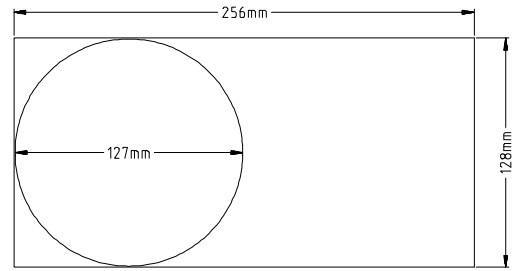

ITEM	SYMBOL	RATING			UNIT
		MIN	TYP	MAX	
Luminous intensity	Red	LvR	35		cd/m <sup>2</sup> (nit), Note 1
	Green	LvG	55		"
Peak Emission Wavelength	Red	$\lambda_{pR}$	630		nm
	Green	$\lambda_{pG}$	567		nm

#### 5. INPUT LEVEL

ITEM	SYMBOL	MIN	TYP	MAX	UNIT
Input"L"	V <sub>iL</sub>	-	-	0.8	V
Input"H"	V <sub>iH</sub>	2.4	-	-	

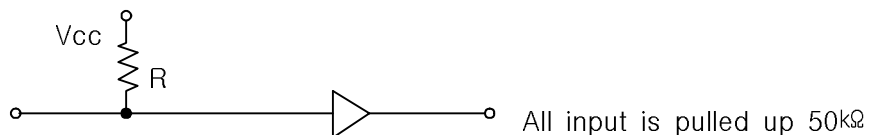

#### 6.FUNCTION

ITEM	PIN NAME	FUNCTION DESCRIPTION	PIN NO.
Power Pin	V <sub>cc1</sub>	Power supply for the circuit	1
	V <sub>cc2</sub>	Power supply for the LED	3,5
	GND	Ground of the module	2,4
Data Pin	RED Data (RD)	Data input for Red color	8
	GREEN Data (GD)	Data input for Green color	6
	Line Address(A0~A3)	Signal input for line address	9,10,11,12
	Clock (CLK)	Clock signal for Data input and display	4
	Latch	Signal input for Data latch (New Data Latch at Rising Edge)	2
	Out Enable (OE)	Display ON or OFF control ( 'H' Display OFF ) ( 'L' Display ON )	1
Brightness Control Switch	GND	Signal Ground	3,5,7
	S/W1 ~ S/W4	Total brightness control of Green color	1,2,3,4
	S/W5 ~ S/W8	Total brightness control of Red color	5,6,7,8

7. BLOCK DIAGRAM

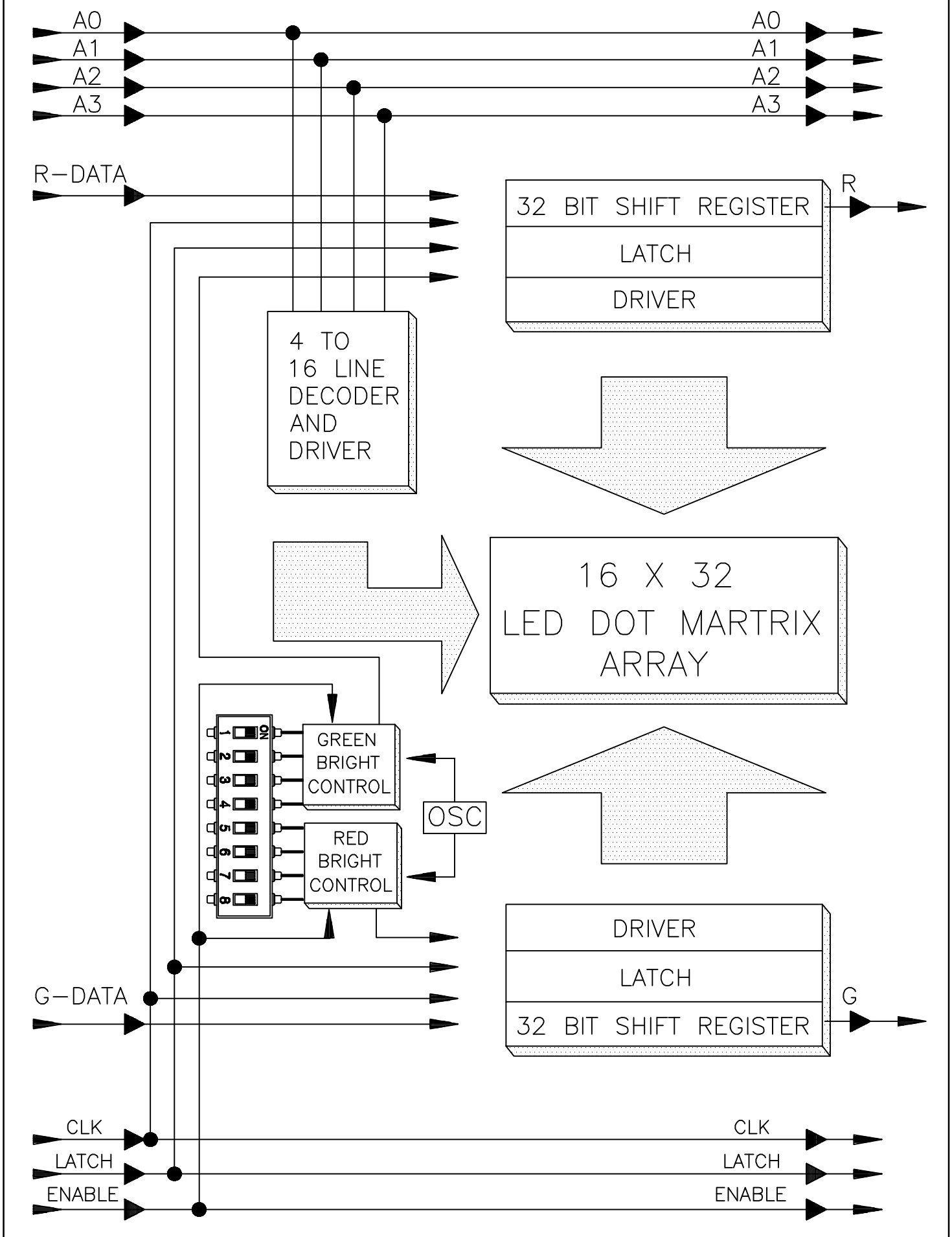

## 8. TIMING

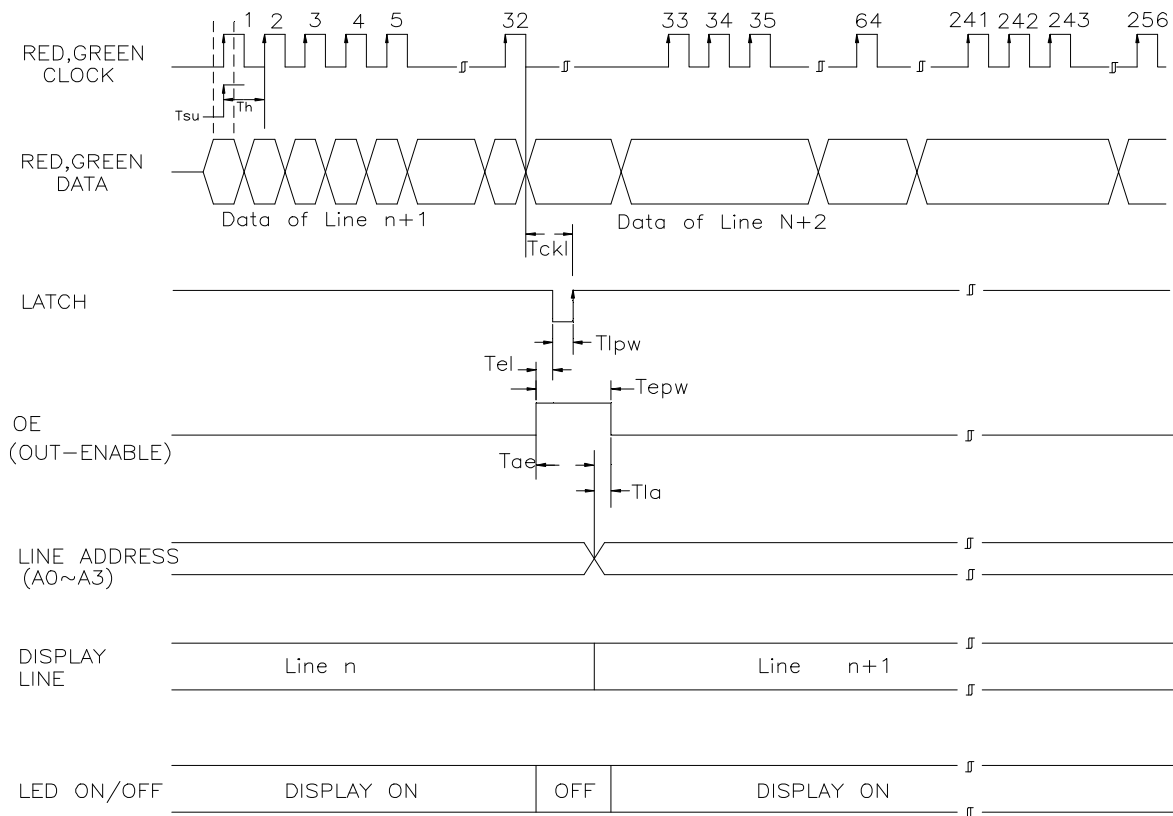

\*\* when the Latch "L" or OE "H" => LED turn Off

### ■ OPERATING TIMING







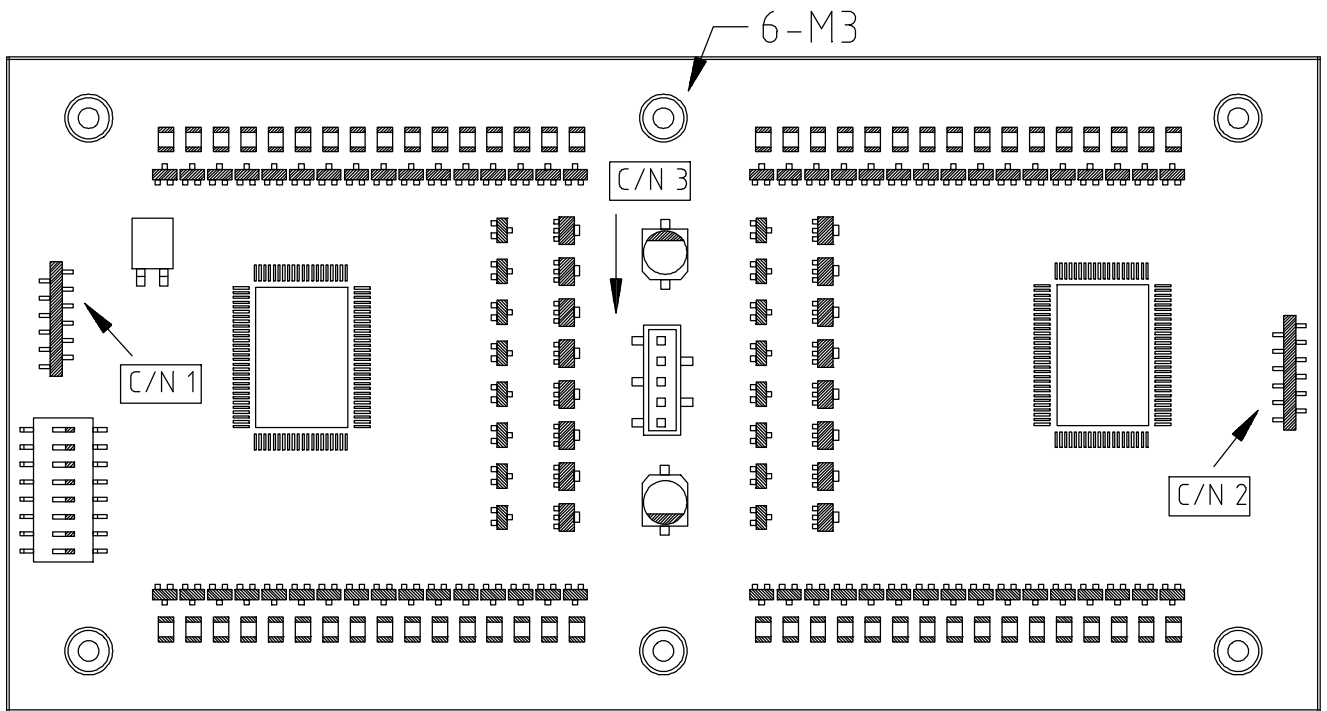





( $T_a=25^\circ\text{C}$ ,  $V_{cc}=5\text{V}$ )

NO	ITEM	SYMBOL	MIN	MAX	UNIT
1	Clock Cycle	T	-	50	MHz
2	Data Set up Time	$T_{su}$	5	-	ns
3	Data Hold Time	$T_{th}$	5	-	ns
4	Latch Pulse Width	$T_{lpw}$	5	-	ns
5	Clock-Latch Time	$T_{ckl}$	20	-	ns
6	Enable-Latch Time	$T_{el}$	3	-	$\mu\text{s}$
7	Enable Pulse Width	$T_{epw}$	3	-	$\mu\text{s}$
8	Address-Enable Time	$T_{ae}$	1.5	-	$\mu\text{s}$
9	Latch-Address Time	$T_{la}$	1.5	-	$\mu\text{s}$













### 9. PIN CONNECTION & SWITCH



#### 1) C.N-1 (DATA INPUT)

	PIN NO.	NAME
	1	OUT ENABLE
	2	LATCH
	3	GND
	4	CLK
	5	GND
	6	G-DATA
	7	GND
	8	R-DATA
	9	A0
	10	A1
	11	A2
	12	A3

#### 2) C.N-2 (DATA OUTPUT)

	PIN NO.	NAME
	1	OUT ENABLE
	2	LATCH
	3	GND
	4	CLK
	5	GND
	6	G-DATA
	7	GND
	8	R-DATA
	9	A0
	10	A1
	11	A2
	12	A3

10. DIMENSION

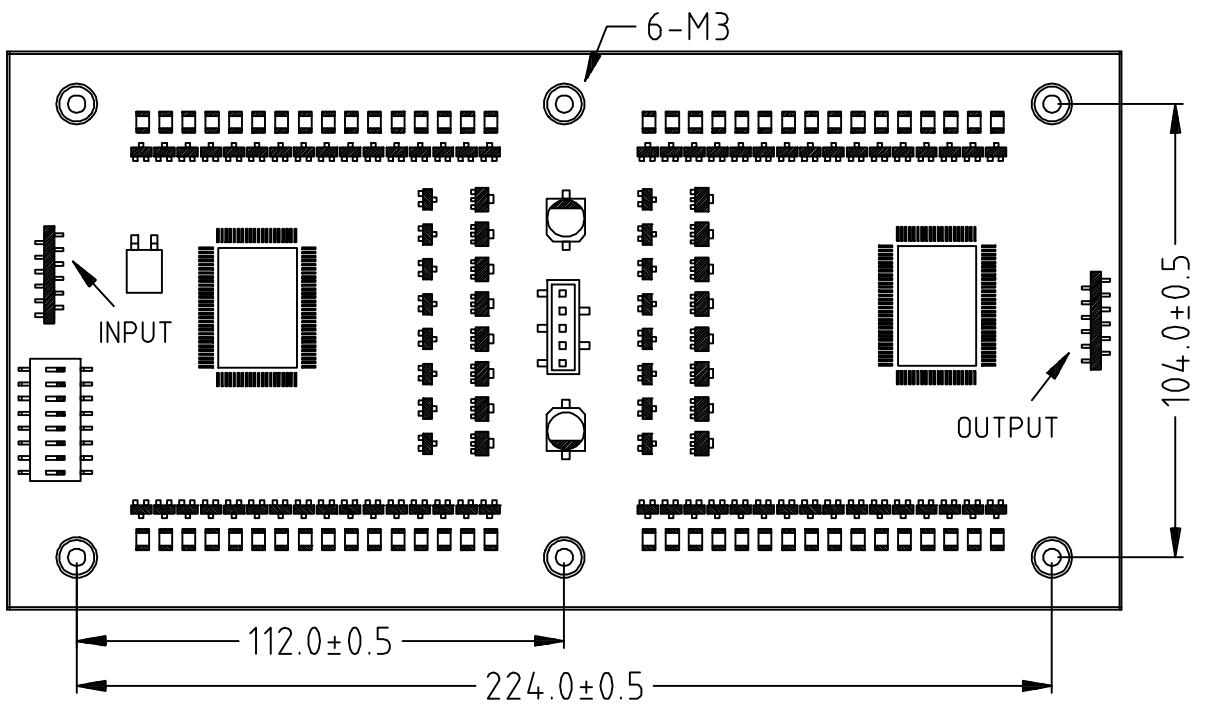
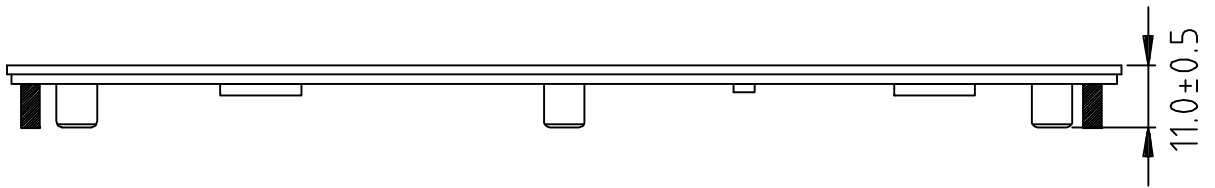
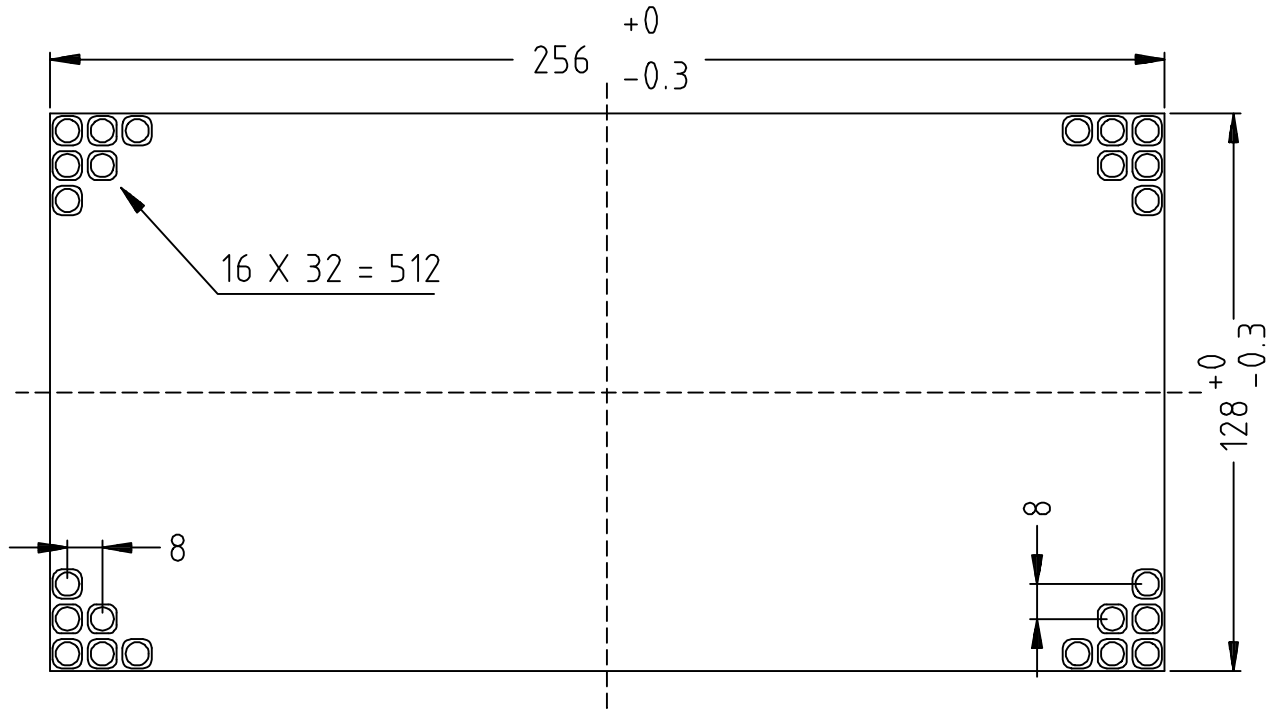

### 11. CONNECTION & CABLE (STANDARD)

#### 1) C.N-1, C.N-2 ( FFC CABLE )

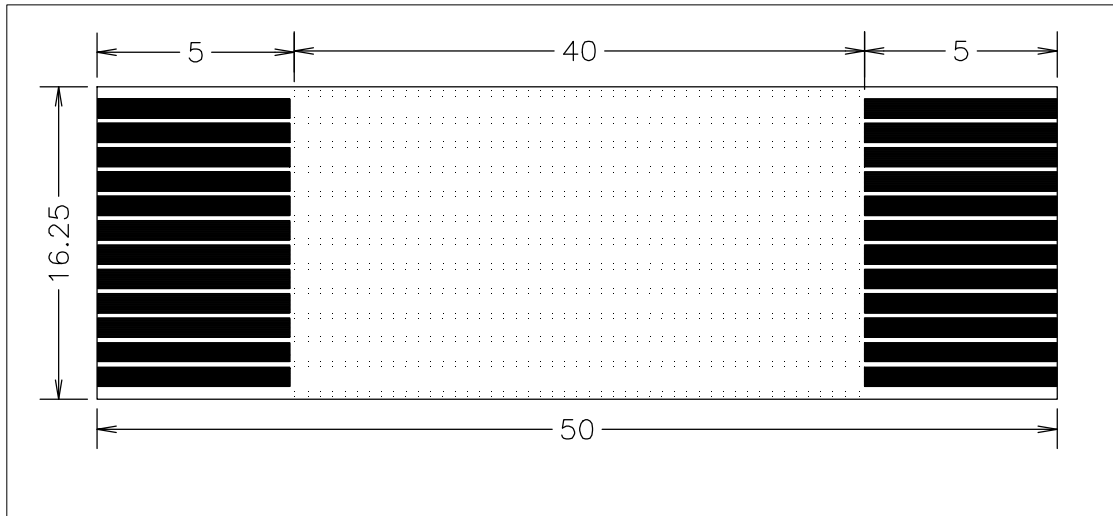

#### 2) C.N-3 ( POWER CABLE )

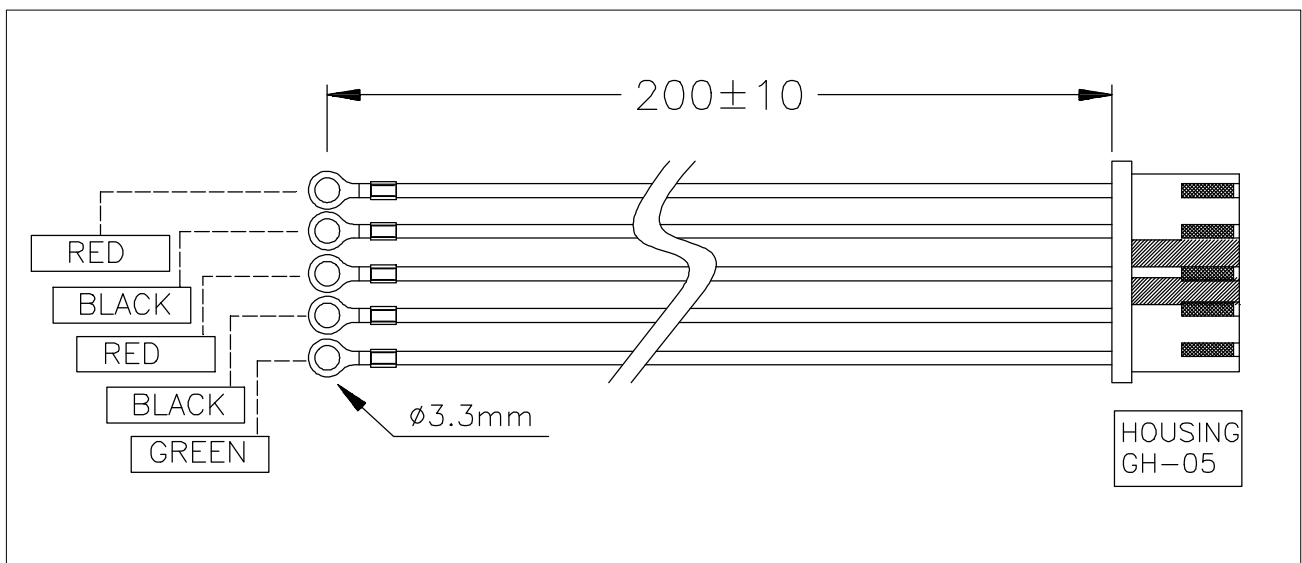

CONNECTION NO.	MODEL NO.	SPEC
C.N-1 , C.N-2	KF2B 12/50P7 S9 B9 :VS3 VB3	12P*50*1.25*7(0.1*0.8)
C.N-3	GH - 0522 - 200R	5P * 200mm



## 3) C.N-3 ( POWER )

PIN NO	NAME	LEVEL	FUNCTION
1	Vcc1	5V	For the Circuit
2,4	GND	0V	Ground
3,5	Vcc2	5V	For the LED

## 4) BRIGHTNESS CONTROL SWITCH

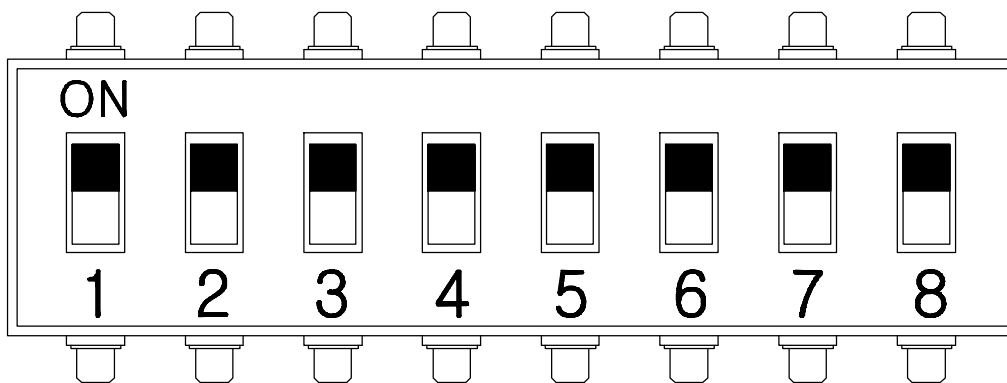

GREEN Bright Level	SWITCH POSITION				RED Bright Level	SWITCH POSITION			
	S/W1	S/W2	S/W3	S/W4		S/W5	S/W6	S/W7	S/W8
0	ON	ON	ON	ON	0	ON	ON	ON	ON
1	ON	ON	ON	OFF	1	ON	ON	ON	OFF
2	ON	ON	OFF	ON	2	ON	ON	OFF	ON
3	ON	ON	OFF	OFF	3	ON	ON	OFF	OFF
4	ON	OFF	ON	ON	4	ON	OFF	ON	ON
5	ON	OFF	ON	OFF	5	ON	OFF	ON	OFF
6	ON	OFF	OFF	ON	6	ON	OFF	OFF	ON
7	ON	OFF	OFF	OFF	7	ON	OFF	OFF	OFF
8	OFF	ON	ON	ON	8	OFF	ON	ON	ON
9	OFF	ON	ON	OFF	9	OFF	ON	ON	OFF

**\*\* Level 0 has the most brightness.**

### 12. The rate of Lits derating curve

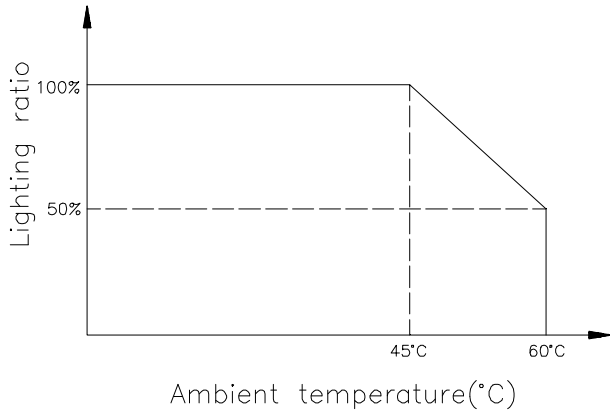

When you drive the module, refer to left graph.

### 13. Data Shift Direction

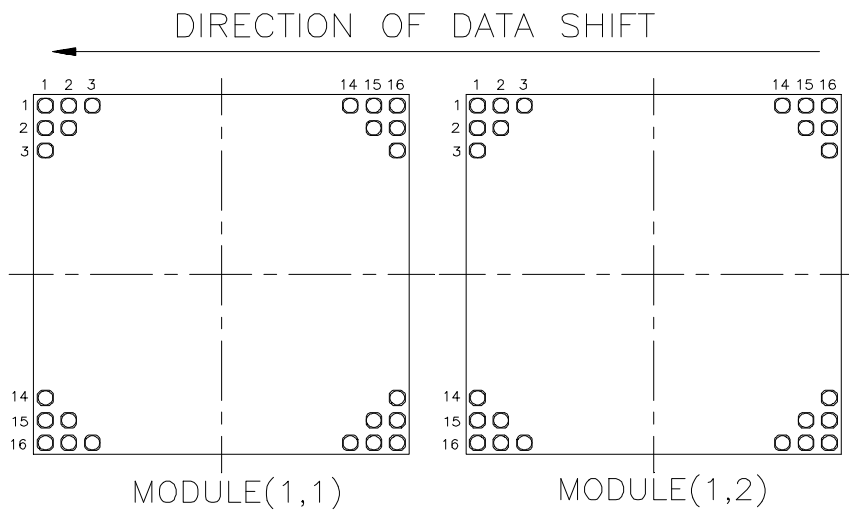

### 14. Example connection

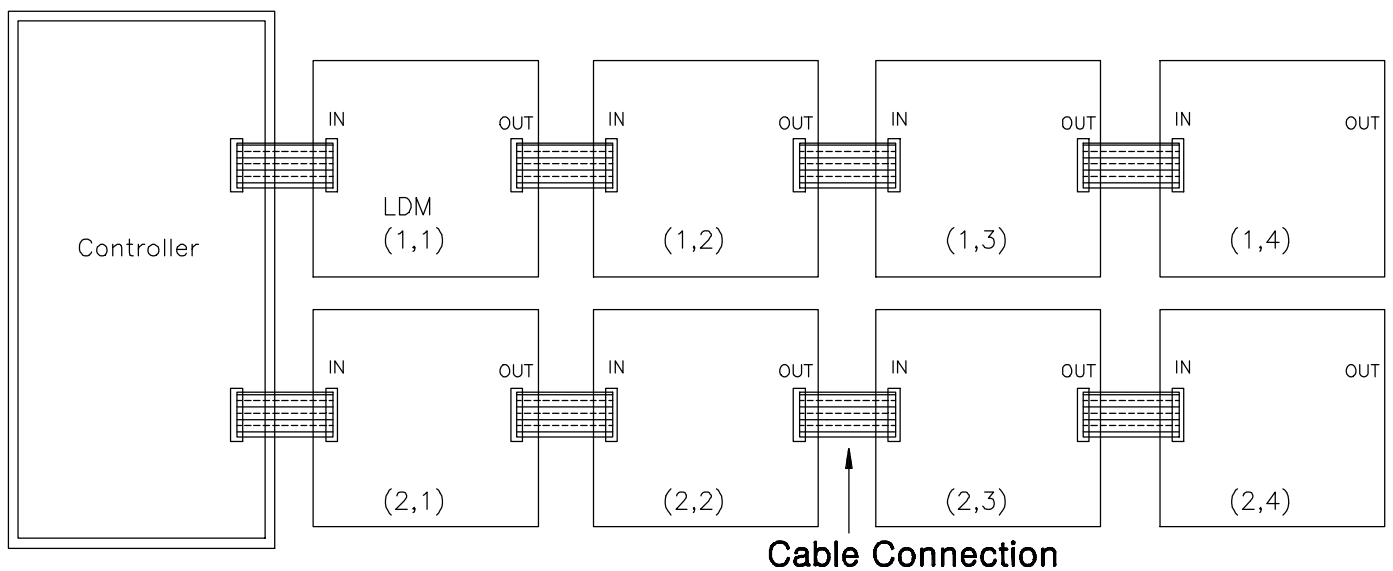

※ The above drawing shows the back side of LDM

## 15. Matter on caution when installed ( assembly )

### 설치(조립)시 주의사항

- 1) It should be installed deeply considered in noisy place because wrong operation might be occurred.

NOISE 환경이 취약한 곳에서는 오동작을 유발할 수 있으므로 충분히 고려하여 설치하도록 하여 주십시오.

- 2) Make sure of power source before operating after being assembled module. Damage may be occurred by low voltage or short circuit.

조립 후 동작을 시험하기 전에 반드시 전원부를 확인하여 주시기 바랍니다.  
과전압, 쇼트등에 의해 MODULE이 파손될 수 있습니다.

- 3) The module is not waterproofed. so, do waterproof treatment to instrument if you need.

본 MODULE은 방수처리가 되어있지 않았으므로 필요시 기구물에 방수가 될 수 있는 처리를 하여 주십시오.

- 4) Please install module within guaranteed scope and specially escape installation from circumstance of smoke, dust, and SO<sub>2</sub>-GAS.

MODULE이 설치되는 환경은 보증범위 내에서 설치하여 주시고, 특히 연기, 먼지, 매연, SO<sub>2</sub>-GAS 등의 환경을 피하여 주십시오.

- 5) Please turn off power source if there is no data transmission when you testing its operation after installation.

설치후 동작시험시 DATA 전송이 없을 경우에는 전원을 OFF 하여 주십시오.

- 6) Please establish policy of heat release and use it under circumstance within guarantee scope in case a lot of module is assembled and used.

다량의 MODULE이 조립되어 사용되는 경우에는 충분한 방열대책을 수립하여 보증범위내의 환경에서만 사용하여 주십시오.

- 7) In case it is used under below zero circumstance, it is favorable to use it with high voltage within maximum extent of value of input power source.

영하 이하의 저온환경 하에서 사용되는 경우에는 입력 전원을 정격치의 최대범위 한도내에서 높은 전압으로 사용하는 것이 유리합니다.

- 8) Please make instrument after examining weight fully as module weight is 213g.

중량을 충분히 검토하여 기구물을 제작하여 주십시오.

## 16. Matter of reference when handling.

### 취급시 참고사항

- 1) Over voltage prevention circuit is built in "LED POWER SUPPLY (Vcc2)" of module and LED will be turned off in case high voltage is supplied beyond maximum extent of regular power.

본 Module의 LED 전원 공급부에는 과전압 방지회로가 내장되어 있어 정격 최대범위 이상의 높은 전압이 공급될 경우 LED 공급전원이 차단 됩니다.

- 2) Switch of brightness adjustment-use is adjusted in fixed rank by LOT and supplied therefore don't operate it as you please.

휘도 조절용 SWITCH 는 출하시 LOT 별로 일정한 RANK로 조정되어 출하되고 있으니 임의의 조작을 삼가 주십시오.

- 3) Operating circuit is composed of CMOS, so, please take caution for static electricity.

구동회로부에 CMOS등이 장착되어 있으므로 동작시험 및 조립시 정전기 대책을 행하여 주시기 바랍니다.

- 4) If you have any question for using this, please contact us.

본 제품의 사용상 의문사항이 발생시 영업담당자를 통하여 문의하여 주십시오.

# Product warranty

## 제 품 보 증

### Warranty contents

#### \* 보 증 내 용 \*

Exchange without compensation will be made for the period of 12 month after having been delivered in case troubles in ordinary treatment in occurred.

Warranty is for delivered products. Expense of exchange work, damage compensation for advertisement suspension is not paid. Also compensative treatment will be made in case of following even for warranty period.

보통 취급상의 고장이 발생했을 경우, 납입후 12개월간은 무상교환하여 드립니다.

또한 보증은 납입제품에 대한 보증이며, 교환작업에 따른 공임, 손해배상, 광고정지에 따른 보상비용등의 경비는 지불하지 않습니다.

또한 다음의 경우에는 보증기간중에도 유상처리 됩니다.

1) Troubles by handling carelessness and wrong using.

취급 부주의 및 잘못사용에 따른 고장

2) Troubles by inapplicable repair or remarking.

부적절한 수리나 개조등에 따른 고장

3) Troubles by natural disaster.

천재지변등에 의한 불가항력적인 고장

© Matters that demand attention and notice in compliance with contents of this document and use of the product.

본 문서에 기재된 내용 및 본 제품의 사용에 따른 주의사항 및 유의점.

- (1) In case that the products mentioned in this document is applicable to foreign exchange and foreign control law, admission of korea government is required when exporting or taking out.

본서에 기재된 제품이 [외국환율 및 외국관리법]에 해당할 경우, 수출시 또는 외국 반출시에는 한국 정부의 허가가 필요합니다.

- (2) Technical information mentioned in this document is record of production characteristics and practical circuit and it is not mean guarantee of possessive right of industry or permission of performance right.

본서에 기재된 기술정보는 제품의 특성 및 응용회로 등을 기록한 것이며, 공업소유권 등의 보증 또는 실시권의 허락을 의미하는 것은 아닙니다.

- (3) Standard use of this production – It is used for general electronic parts (indicators, Display, office machine measuring equipment and home consumer products). When it is used for specific use (Aviation space, Traffic equipment, Burning equipment and safety equipment, ETC) which special quality and reliability is required and when trouble or miss operation of these threaten human's life or do harm to person, you should discuss it with us in advance considering using except standard use of our intention.

본 제품의 표준 용도 : 일반 전자부품 (표시기기, 사무기기, 계측기기, 가전제품등) 등에 사용됩니다.

특별한 품질, 신뢰성이 요구되며 이것의 고장이나 오동작이 직접적으로 인명을 위협하거나 인체에 위해를 끼칠 위험이 있는 특정용도 : (항공/우주용, 교통기기, 연소기기, 안전장치등)에 사용시는 폐사가 의도한 표준용도 이외의 사용을 고려, 사전에 폐사와 상담하십시오.

- (4) You should use it within the warranty scope for special maximum rating operation power source electronic voltage scope and heat release ability.  
We are not responsible for the defect that occur to instrument when it is used beyond our warranty measures.

설계시에 특히 최대정격, 동작전원 전압범위, 방열성에 대해서는 보증범위 내에서 사용하시기 바랍니다.

보증치수를 넘겨 사용했을 경우 그 후에 발생한 기기의 결함에 대해서는 폐사에서 책임지지 않습니다.

- ◎ If you have any question or change required about the specification, please solve it after agreement with us.

- ◎ 본 사양에 관한 질문이나 변경이 필요한 경우, 폐사와 합의후 해결하십시오.