

## Automotive-grade N-channel 650 V, 0.024 $\Omega$ typ., 69 A, MDmesh™ V Power MOSFET in a TO-247 package

Datasheet - production data

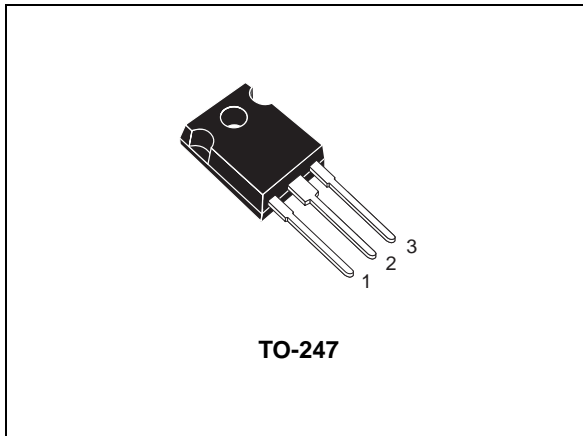
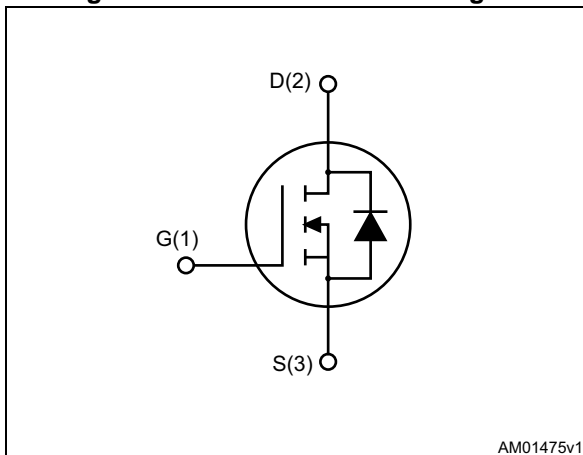

Figure 1. Internal schematic diagram



### Features

| Order code | $V_{DS} @ T_{jmax.}$ | $R_{DS(on) max.}$ | $I_D$ |
|------------|----------------------|-------------------|-------|
| STW78N65M5 | 710 V                | 0.032 $\Omega$    | 69 A  |

- Designed for automotive applications and AEC-Q101 qualified
- Higher  $V_{DSS}$  rating
- Higher dv/dt capability
- Excellent switching performance
- Easy to drive
- 100% avalanche tested

### Applications

- Switching applications

### Description

This device is an N-channel MDmesh™ V Power MOSFET based on an innovative proprietary vertical process technology, which is combined with STMicroelectronics' well-known PowerMESH™ horizontal layout structure. The resulting product has extremely low on-resistance, which is unmatched among silicon-based Power MOSFETs, making it especially suitable for applications which require superior power density and outstanding efficiency.

Table 1. Device summary

| Order code | Marking | Package | Packaging |
|------------|---------|---------|-----------|
| STW78N65M5 | 78N65M5 | TO-247  | Tube      |

# Contents

|          |   |           |
|----------|---|-----------|
| <b>1</b> | <b>Electrical ratings</b> .....               | <b>3</b>  |
| <b>2</b> | <b>Electrical characteristics</b> .....       | <b>4</b>  |
|          | 2.1 Electrical characteristics (curves) ..... | 6         |
| <b>3</b> | <b>Test circuits</b> .....                    | <b>9</b>  |
| <b>4</b> | <b>Package mechanical data</b> .....          | <b>10</b> |
| <b>5</b> | <b>Revision history</b> .....                 | <b>13</b> |

# 1 Electrical ratings

**Table 2. Absolute maximum ratings**

| Symbol         | Parameter   | Value       | Unit             |
|----------------|---|-------------|------------------|
| $V_{GS}$       | Gate- source voltage  | $\pm 25$    | V                |
| $I_D$          | Drain current (continuous) at $T_C = 25\text{ }^\circ\text{C}$  | 69          | A                |
| $I_D$          | Drain current (continuous) at $T_C = 100\text{ }^\circ\text{C}$ | 41.5        | A                |
| $I_{DM}^{(1)}$ | Drain current (pulsed)  | 276         | A                |
| $P_{TOT}$      | Total dissipation at $T_C = 25\text{ }^\circ\text{C}$           | 450         | W                |
| $dv/dt^{(2)}$  | Peak diode recovery voltage slope                               | 15          | V/ns             |
| $dv/dt^{(3)}$  | MOSFET $dv/dt$ ruggedness                                       | 50          | V/ns             |
| $T_{stg}$      | Storage temperature   | - 55 to 150 | $^\circ\text{C}$ |
| $T_j$          | Max. operating junction temperature                             | 150         | $^\circ\text{C}$ |

1. Pulse width limited by safe operating area
2.  $I_{SD} \leq 69\text{ A}$ ,  $di/dt = 400\text{ A}/\mu\text{s}$ ,  $V_{DS\text{ peak}} < V_{(BR)DSS}$ ,  $V_{DD} = 400\text{ V}$
3.  $V_{DS} \leq 520\text{ V}$

**Table 3. Thermal data**

| Symbol                | Parameter                               | Value | Unit                      |
|-----------------------|---|-------|---------------------------|
| $R_{thj\text{-case}}$ | Thermal resistance junction-case max    | 0.28  | $^\circ\text{C}/\text{W}$ |
| $R_{thj\text{-amb}}$  | Thermal resistance junction-ambient max | 50    | $^\circ\text{C}/\text{W}$ |

**Table 4. Avalanche characteristics**

| Symbol   | Parameter  | Value | Unit |
|----------|--|-------|------|
| $I_{AR}$ | Max current during repetitive or single pulse avalanche (pulse width limited by $T_{JMAX}$ )                         | 15    | A    |
| $E_{AS}$ | Single pulse avalanche energy (starting $T_j = 25\text{ }^\circ\text{C}$ , $I_D = I_{AR}$ , $V_{DD} = 50\text{ V}$ ) | 2000  | mJ   |

## 2 Electrical characteristics

( $T_C = 25\text{ °C}$  unless otherwise specified)

**Table 5. On /off states**

| Symbol        | Parameter  | Test conditions   | Min. | Typ.  | Max.      | Unit                           |
|---------------|--|---|------|-------|-----------|--------------------------------|
| $V_{(BR)DSS}$ | Drain-source breakdown voltage ( $V_{GS} = 0$ )  | $I_D = 1\text{ mA}$   | 650  |       |           | V                              |
| $I_{DSS}$     | Zero gate voltage drain current ( $V_{GS} = 0$ ) | $V_{DS} = 650\text{ V}$<br>$V_{DS} = 650\text{ V}, T_C = 125\text{ °C}$ |      |       | 1<br>100  | $\mu\text{A}$<br>$\mu\text{A}$ |
| $I_{GSS}$     | Gate-body leakage current ( $V_{DS} = 0$ )       | $V_{GS} = \pm 25\text{ V}$  |      |       | $\pm 100$ | nA                             |
| $V_{GS(th)}$  | Gate threshold voltage                           | $V_{DS} = V_{GS}, I_D = 250\text{ }\mu\text{A}$                         | 3    | 4     | 5         | V                              |
| $R_{DS(on)}$  | Static drain-source on-resistance                | $V_{GS} = 10\text{ V}, I_D = 34.5\text{ A}$                             |      | 0.024 | 0.032     | $\Omega$                       |

**Table 6. Dynamic**

| Symbol            | Parameter                             | Test conditions   | Min. | Typ. | Max. | Unit     |
|-------------------|---------------------------------------|---|------|------|------|----------|
| $C_{iss}$         | Input capacitance                     | $V_{DS} = 100\text{ V}, f = 1\text{ MHz},$<br>$V_{GS} = 0$  | -    | 9000 | -    | pF       |
| $C_{oss}$         | Output capacitance                    |   | -    | 210  | -    | pF       |
| $C_{rss}$         | Reverse transfer capacitance          |   | -    | 9    | -    | pF       |
| $C_{o(tr)}^{(1)}$ | Equivalent capacitance time related   | $V_{GS} = 0, V_{DS} = 0\text{ to }520\text{ V}$   | -    | 768  | -    | pF       |
| $C_{o(er)}^{(2)}$ | Equivalent capacitance energy related | $V_{GS} = 0, V_{DS} = 0\text{ to }520\text{ V}$   | -    | 205  | -    | pF       |
| $R_G$             | Intrinsic gate resistance             | $f = 1\text{ MHz open drain}$   | -    | 1.5  | -    | $\Omega$ |
| $Q_g$             | Total gate charge                     | $V_{DD} = 520\text{ V}, I_D = 34.5\text{ A},$<br>$V_{GS} = 10\text{ V}$<br>(see <a href="#">Figure 16</a> ) | -    | 203  | -    | nC       |
| $Q_{gs}$          | Gate-source charge                    |   | -    | 50   | -    | nC       |
| $Q_{gd}$          | Gate-drain charge                     |   | -    | 84   | -    | nC       |

- $C_{o(tr)}$  is a constant capacitance value that gives the same charging time as  $C_{oss}$  while  $V_{DS}$  is rising from 0 to 80%  $V_{DSS}$ .
- $C_{o(er)}$  is a constant capacitance value that gives the same stored energy as  $C_{oss}$  while  $V_{DS}$  is rising from 0 to 80%  $V_{DSS}$ .

Table 7. Switching times

| Symbol       | Parameter          | Test conditions   | Min. | Typ. | Max. | Unit |
|--------------|--------------------|---|------|------|------|------|
| $t_{d(V)}$   | Voltage delay time | $V_{DD} = 400\text{ V}$ , $I_D = 40\text{ A}$ ,<br>$R_G = 4.7\ \Omega$ , $V_{GS} = 10\text{ V}$<br>(see <a href="#">Figure 17</a> )<br>(see <a href="#">Figure 20</a> ) | -    | 163  | -    | ns   |
| $t_{r(V)}$   | Voltage rise time  |   | -    | 14   | -    | ns   |
| $t_{f(i)}$   | Current fall time  |   | -    | 14   | -    | ns   |
| $t_{c(off)}$ | Crossing time      |   | -    | 26   | -    | ns   |

Table 8. Source drain diode

| Symbol          | Parameter                     | Test conditions   | Min. | Typ. | Max. | Unit          |
|-----------------|-------------------------------|---|------|------|------|---------------|
| $I_{SD}$        | Source-drain current          |   | -    |      | 69   | A             |
| $I_{SDM}^{(1)}$ | Source-drain current (pulsed) |   | -    |      | 276  | A             |
| $V_{SD}^{(2)}$  | Forward on voltage            | $I_{SD} = 69\text{ A}$ , $V_{GS} = 0$   | -    |      | 1.5  | V             |
| $t_{rr}$        | Reverse recovery time         | $I_{SD} = 69\text{ A}$ ,<br>$di/dt = 100\text{ A}/\mu\text{s}$  | -    | 504  |      | ns            |
| $Q_{rr}$        | Reverse recovery charge       |   | -    | 13   |      | $\mu\text{C}$ |
| $I_{RRM}$       | Reverse recovery current      | $V_{DD} = 100\text{ V}$ (see <a href="#">Figure 17</a> )  | -    | 49   |      | A             |
| $t_{rr}$        | Reverse recovery time         | $I_{SD} = 69\text{ A}$ ,<br>$di/dt = 100\text{ A}/\mu\text{s}$<br>$V_{DD} = 100\text{ V}$ , $T_j = 150\text{ }^\circ\text{C}$<br>(see <a href="#">Figure 17</a> ) | -    | 635  |      | ns            |
| $Q_{rr}$        | Reverse recovery charge       |   | -    | 19   |      | $\mu\text{C}$ |
| $I_{RRM}$       | Reverse recovery current      |   | -    | 59   |      | A             |

1. Pulse width limited by safe operating area
2. Pulsed: pulse duration = 300  $\mu\text{s}$ , duty cycle 1.5%

## 2.1 Electrical characteristics (curves)

Figure 2. Safe operating area

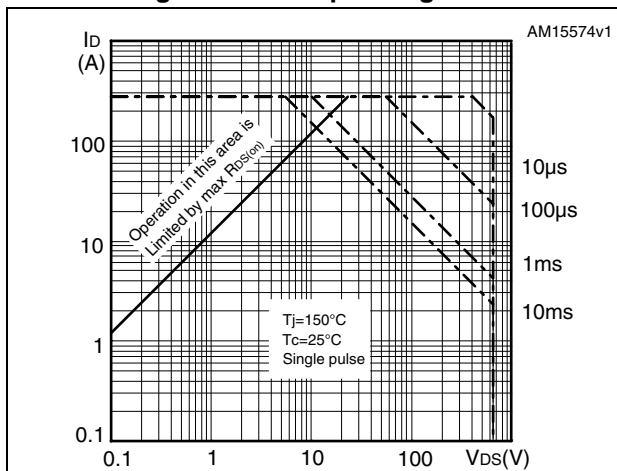

Figure 3. Thermal impedance

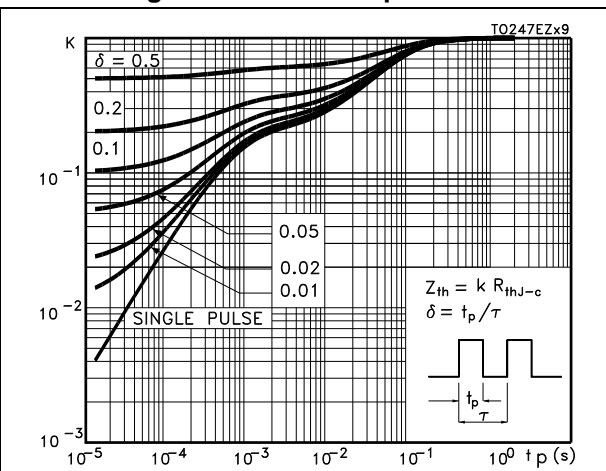

Figure 4. Output characteristics

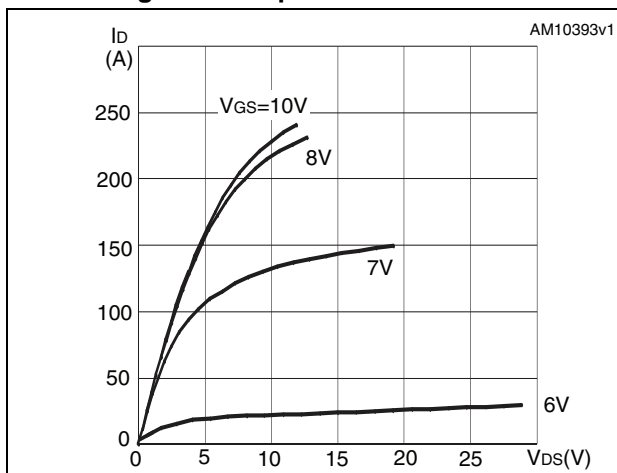

Figure 5. Transfer characteristics

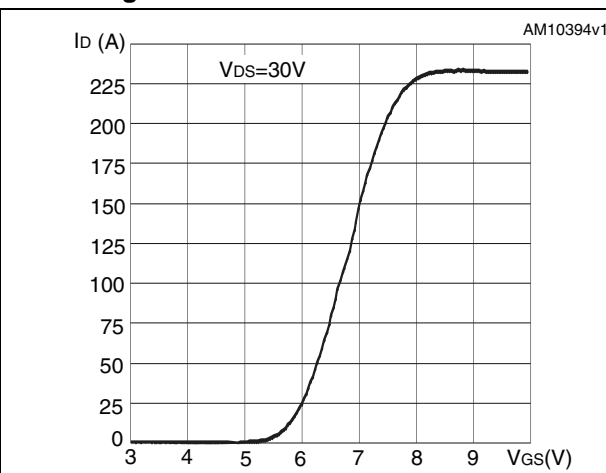

Figure 6. Gate charge vs gate-source voltage

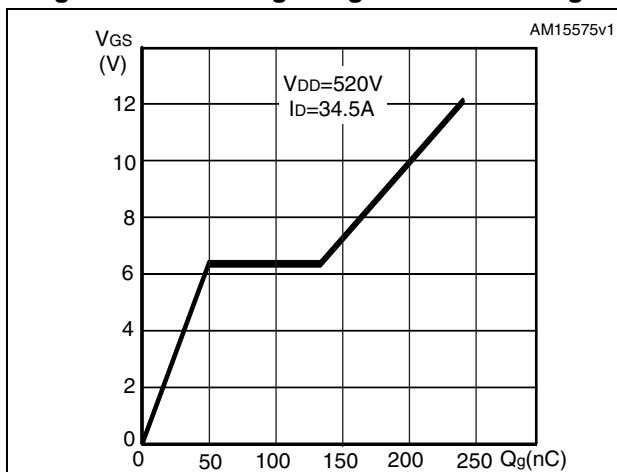

Figure 7. Static drain-source on-resistance

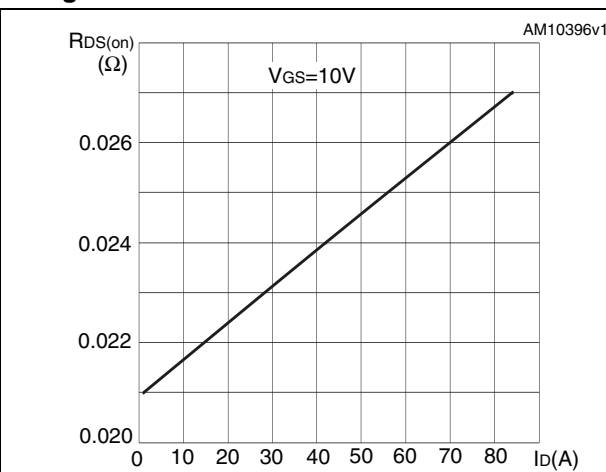

Figure 8. Capacitance variations

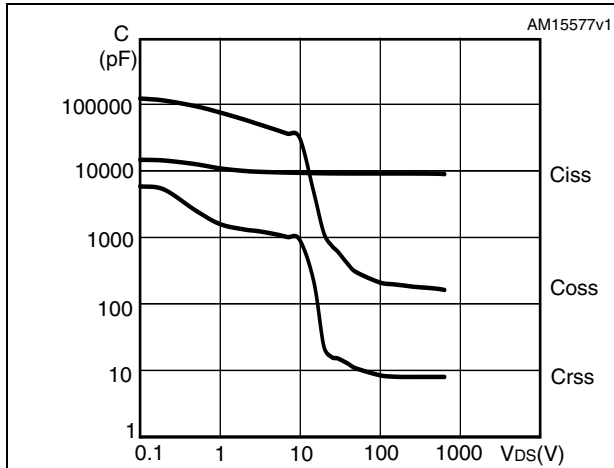

Figure 9. Output capacitance stored energy

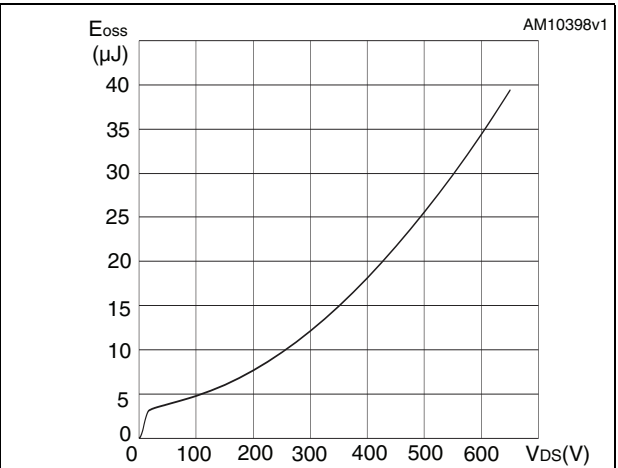

Figure 10. Normalized gate threshold voltage vs temperature

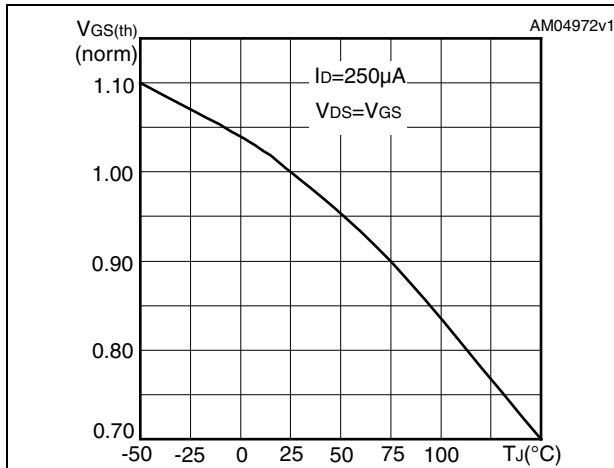

Figure 11. Normalized on-resistance vs temperature

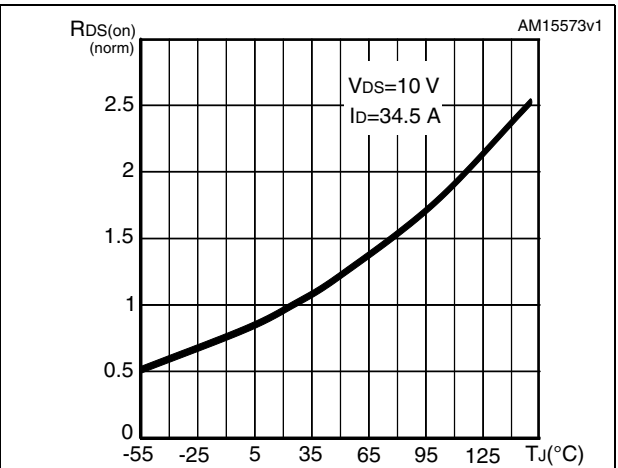

Figure 12. Source-drain diode forward characteristics

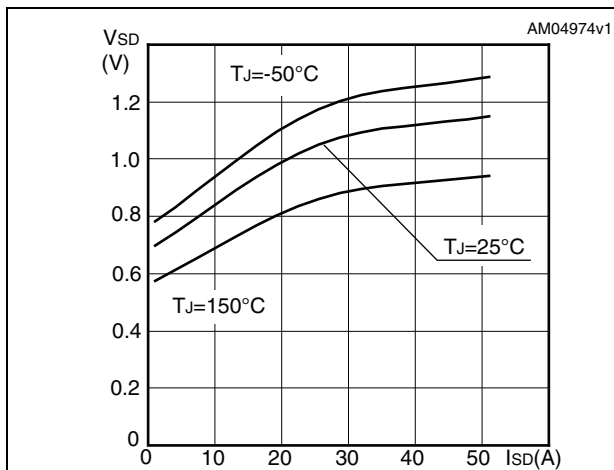

Figure 13. Normalized VDS vs temperature

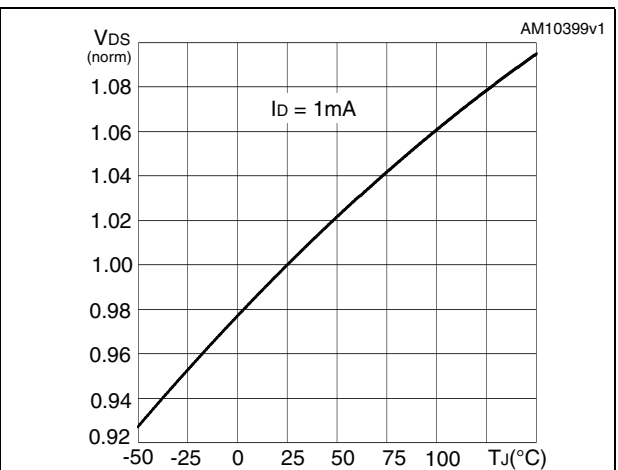
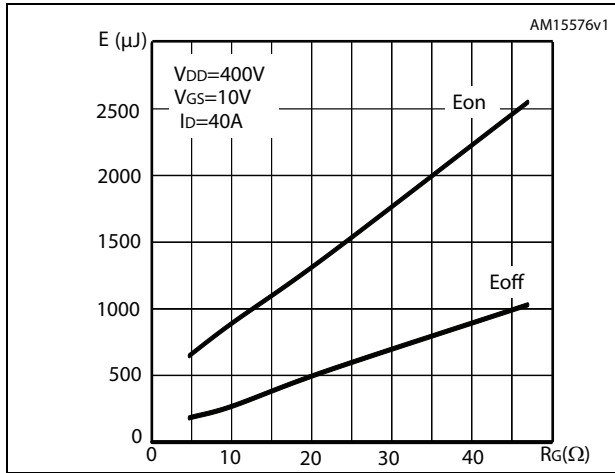

Figure 14. Switching losses vs gate resistance (1)



1.  $E_{on}$  including reverse recovery of a SiC diode



### 3 Test circuits

Figure 15. Switching times test circuit for resistive load



Figure 16. Gate charge test circuit



Figure 17. Test circuit for inductive load switching and diode recovery times



Figure 18. Unclamped inductive load test circuit



Figure 19. Unclamped inductive waveform

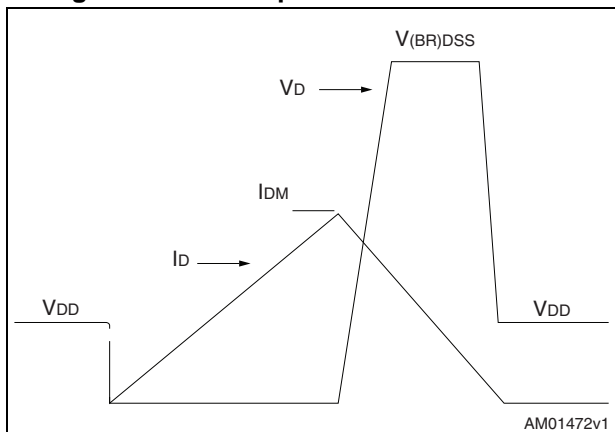
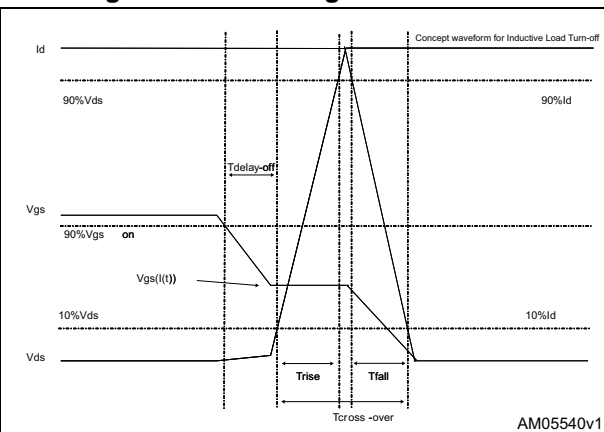

Figure 20. Switching time waveform



## 4 Package mechanical data

In order to meet environmental requirements, ST offers these devices in different grades of ECOPACK<sup>®</sup> packages, depending on their level of environmental compliance. ECOPACK<sup>®</sup> specifications, grade definitions and product status are available at: [www.st.com](http://www.st.com). ECOPACK is an ST trademark.

Table 9. TO-247 mechanical data

| Dim. | mm.   |       |       |
|------|-------|-------|-------|
|      | Min.  | Typ.  | Max.  |
| A    | 4.85  |       | 5.15  |
| A1   | 2.20  |       | 2.60  |
| b    | 1.0   |       | 1.40  |
| b1   | 2.0   |       | 2.40  |
| b2   | 3.0   |       | 3.40  |
| c    | 0.40  |       | 0.80  |
| D    | 19.85 |       | 20.15 |
| E    | 15.45 |       | 15.75 |
| e    | 5.30  | 5.45  | 5.60  |
| L    | 14.20 |       | 14.80 |
| L1   | 3.70  |       | 4.30  |
| L2   |       | 18.50 |       |
| ØP   | 3.55  |       | 3.65  |
| ØR   | 4.50  |       | 5.50  |
| S    | 5.30  | 5.50  | 5.70  |

Figure 21. TO-247 drawing

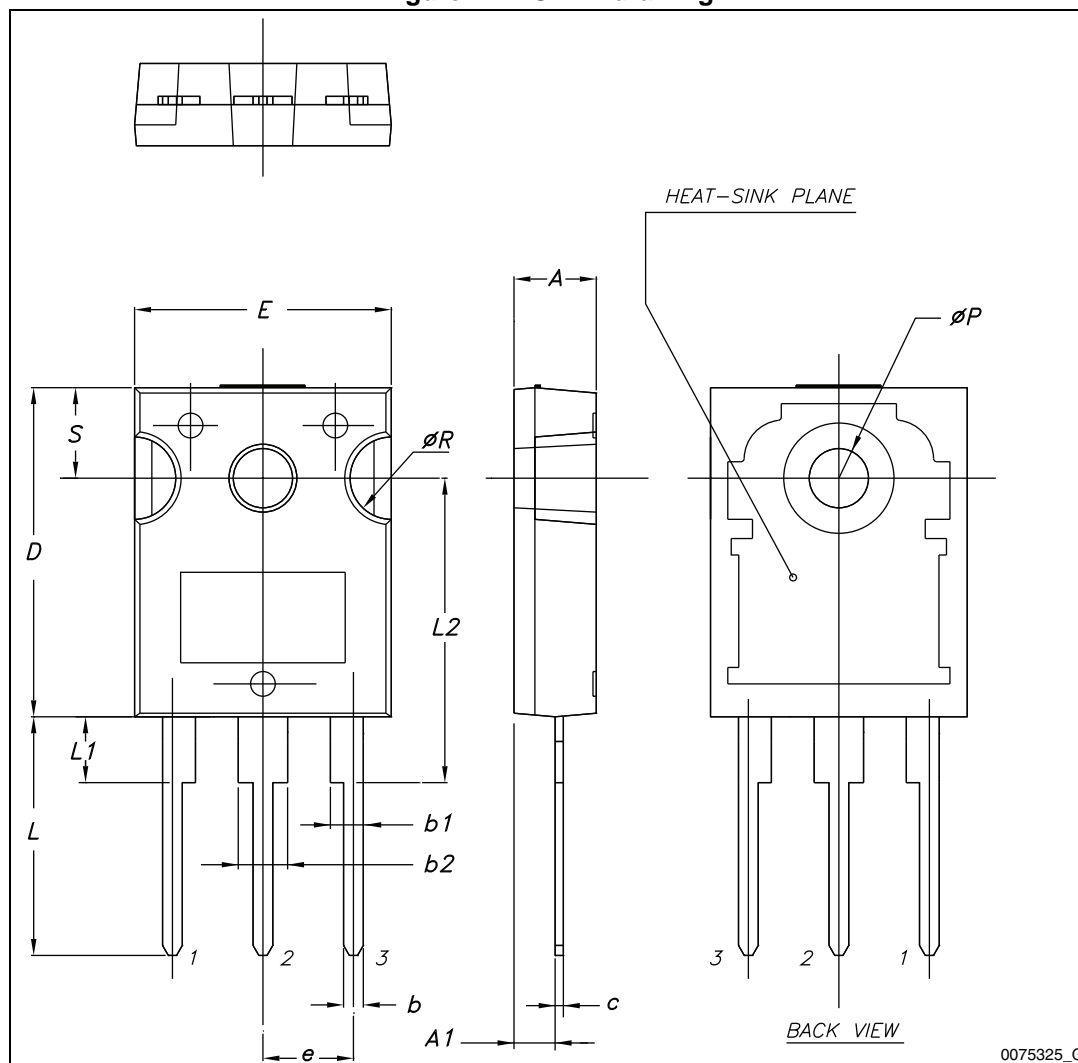

0075325\_G

## 5 Revision history

**Table 10. Document revision history**

| Date        | Revision | Changes  |
|-------------|----------|--|
| 16-Jul-2012 | 1        | First release.   |
| 22-Jan-2013 | 2        | Modified: $R_{DS(on)}$ on first page, $I_D$ , $I_{DM}$ on <a href="#">Table 2</a> , note 2 on <a href="#">Table 2</a> , typical values on <a href="#">Table 6</a> , <a href="#">7</a> , max and typical values on <a href="#">Table 8</a> , <a href="#">Figure 2</a> , <a href="#">6</a> , <a href="#">8</a> , <a href="#">9</a> , <a href="#">11</a> and <a href="#">14</a>                             |
| 07-Aug-2013 | 3        | <ul style="list-style-type: none"> <li>– Minor text changes</li> <li>– Modified: <a href="#">Applications</a> in first page</li> <li>– Added: MOSFET dv/dt ruggedness parameter in <a href="#">Table 2</a></li> <li>– Added: <a href="#">Table 4: Avalanche characteristics</a></li> <li>– Modified: <a href="#">Figure 15</a>, <a href="#">16</a>, <a href="#">17</a> and <a href="#">18</a></li> </ul> |
| 08-Aug-2013 | 4        | <ul style="list-style-type: none"> <li>– Minor text changes</li> <li>– Modified: <a href="#">Figure 14</a></li> </ul>  |

**Please Read Carefully:**

Information in this document is provided solely in connection with ST products. STMicroelectronics NV and its subsidiaries ("ST") reserve the right to make changes, corrections, modifications or improvements, to this document, and the products and services described herein at any time, without notice.

All ST products are sold pursuant to ST's terms and conditions of sale.

Purchasers are solely responsible for the choice, selection and use of the ST products and services described herein, and ST assumes no liability whatsoever relating to the choice, selection or use of the ST products and services described herein.

No license, express or implied, by estoppel or otherwise, to any intellectual property rights is granted under this document. If any part of this document refers to any third party products or services it shall not be deemed a license grant by ST for the use of such third party products or services, or any intellectual property contained therein or considered as a warranty covering the use in any manner whatsoever of such third party products or services or any intellectual property contained therein.

**UNLESS OTHERWISE SET FORTH IN ST'S TERMS AND CONDITIONS OF SALE ST DISCLAIMS ANY EXPRESS OR IMPLIED WARRANTY WITH RESPECT TO THE USE AND/OR SALE OF ST PRODUCTS INCLUDING WITHOUT LIMITATION IMPLIED WARRANTIES OF MERCHANTABILITY, FITNESS FOR A PARTICULAR PURPOSE (AND THEIR EQUIVALENTS UNDER THE LAWS OF ANY JURISDICTION), OR INFRINGEMENT OF ANY PATENT, COPYRIGHT OR OTHER INTELLECTUAL PROPERTY RIGHT.**

**ST PRODUCTS ARE NOT AUTHORIZED FOR USE IN WEAPONS. NOR ARE ST PRODUCTS DESIGNED OR AUTHORIZED FOR USE IN: (A) SAFETY CRITICAL APPLICATIONS SUCH AS LIFE SUPPORTING, ACTIVE IMPLANTED DEVICES OR SYSTEMS WITH PRODUCT FUNCTIONAL SAFETY REQUIREMENTS; (B) AERONAUTIC APPLICATIONS; (C) AUTOMOTIVE APPLICATIONS OR ENVIRONMENTS, AND/OR (D) AEROSPACE APPLICATIONS OR ENVIRONMENTS. WHERE ST PRODUCTS ARE NOT DESIGNED FOR SUCH USE, THE PURCHASER SHALL USE PRODUCTS AT PURCHASER'S SOLE RISK, EVEN IF ST HAS BEEN INFORMED IN WRITING OF SUCH USAGE, UNLESS A PRODUCT IS EXPRESSLY DESIGNATED BY ST AS BEING INTENDED FOR "AUTOMOTIVE, AUTOMOTIVE SAFETY OR MEDICAL" INDUSTRY DOMAINS ACCORDING TO ST PRODUCT DESIGN SPECIFICATIONS. PRODUCTS FORMALLY ESCC, QML OR JAN QUALIFIED ARE DEEMED SUITABLE FOR USE IN AEROSPACE BY THE CORRESPONDING GOVERNMENTAL AGENCY.**

Resale of ST products with provisions different from the statements and/or technical features set forth in this document shall immediately void any warranty granted by ST for the ST product or service described herein and shall not create or extend in any manner whatsoever, any liability of ST.

ST and the ST logo are trademarks or registered trademarks of ST in various countries.

Information in this document supersedes and replaces all information previously supplied.

The ST logo is a registered trademark of STMicroelectronics. All other names are the property of their respective owners.

© 2013 STMicroelectronics - All rights reserved

STMicroelectronics group of companies

Australia - Belgium - Brazil - Canada - China - Czech Republic - Finland - France - Germany - Hong Kong - India - Israel - Italy - Japan - Malaysia - Malta - Morocco - Philippines - Singapore - Spain - Sweden - Switzerland - United Kingdom - United States of America

[www.st.com](http://www.st.com)