

**N-CHANNEL MOSFET**

# MTN138KS3

**Description**

The MTN138KS3 is a N-channel enhancement-mode MOSFET.

**Features**

- Low on-resistance
- High ESD
- High speed switching
- Low-voltage drive
- Easily designed drive circuits
- Easy to use in parallel
- Pb-free package

**Symbol**

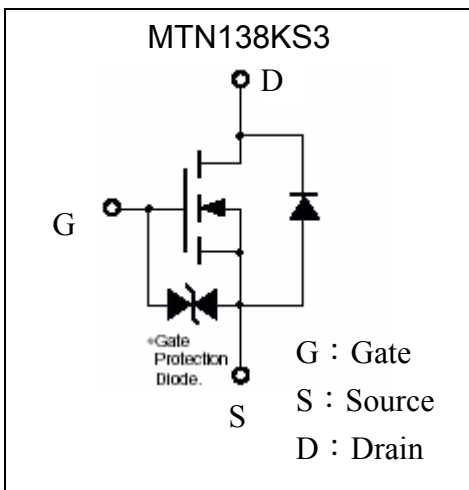

**Outline**

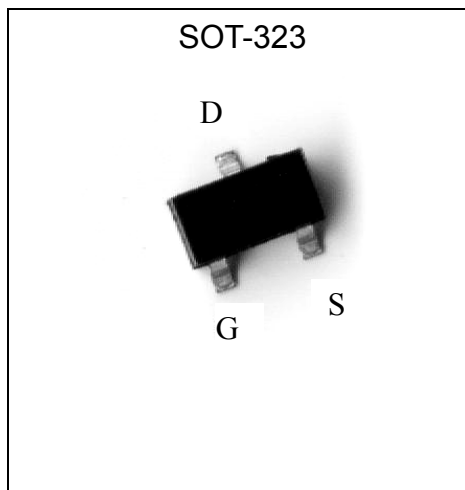

**Ordering Information**

Device	Package	Shipping
MTN138KS3-0-T1-G	SOT-323 (Pb-free lead plating and halogen-free package)	3000 pcs / Tape & Reel



**Absolute Maximum Ratings (Ta=25°C)**

Parameter		Symbol	Limits	Unit
Drain-Source Voltage		V <sub>DSS</sub>	60	V
Gate-Source Voltage		V <sub>GSS</sub>	±20	V
Drain Current	Continuous	I <sub>D</sub>	220	mA
	Pulsed	I <sub>DP</sub>	800 *1	
Drain Reverse Current	Continuous	I <sub>DR</sub>	220	
	Pulsed	I <sub>DRP</sub>	800 *1	
Total Power Dissipation		P <sub>D</sub>	200 *2	mW
Thermal Resistance, Junction to Ambient		R <sub>θJA</sub>	625 *2	°C/W
ESD susceptibility			1500 *3	V
Operating Channel Temperature Range		T <sub>CH</sub>	-55~+150	°C
Storage Temperature Range		T <sub>stg</sub>	-55~+150	

Note : \*1. Pulse Width ≤ 300μs, Duty cycle ≤ 2%  
 \*2. When the device is mounted on a minimum pad size  
 \*3. Human body model, 1.5kΩ in series with 100pF

**Electrical Characteristics (Ta=25°C)**

Symbol	Min.	Typ.	Max.	Unit	Test Conditions
<b>Static</b>					
BV <sub>DSS</sub> *	60	-	-	V	V <sub>GS</sub> =0, I <sub>D</sub> =10μA
V <sub>GS(th)</sub>	0.5	1.2	1.5		V <sub>DS</sub> =V <sub>GS</sub> , I <sub>D</sub> =250μA
I <sub>GSS</sub>	-	-	±10	μA	V <sub>GS</sub> =±20V, V <sub>DS</sub> =0
I <sub>DSS</sub>	-	-	1		V <sub>DS</sub> =60V, V <sub>GS</sub> =0
R <sub>DS(ON)</sub> *	-	1.2	3	Ω	I <sub>D</sub> =220mA, V <sub>GS</sub> =10V
	-	1.4	3.2		I <sub>D</sub> =220mA, V <sub>GS</sub> =4.5V
G <sub>FS</sub>	200	360	-	mS	V <sub>DS</sub> =10V, I <sub>D</sub> =220mA
<b>Dynamic</b>					
C <sub>iss</sub>	-	29	-	pF	V <sub>DS</sub> =25V, V <sub>GS</sub> =0, f=1MHz
C <sub>oss</sub>	-	4	-		
C <sub>rss</sub>	-	2.8	-		
t <sub>d(ON)</sub>	-	3	-	ns	V <sub>DS</sub> =30V, I <sub>D</sub> =200mA, V <sub>GS</sub> =10V, R <sub>G</sub> =6Ω
t <sub>r</sub>	-	5	-		
t <sub>d(OFF)</sub>	-	14	-		
t <sub>f</sub>	-	9	-		
Q <sub>g</sub>	-	1.1	-	nC	V <sub>DS</sub> =30V, I <sub>D</sub> =200mA, V <sub>GS</sub> =10V
Q <sub>gs</sub>	-	0.1	-		
Q <sub>gd</sub>	-	0.23	-		
<b>Source-Drain Diode</b>					
*V <sub>SD</sub>	-	0.8	1.2	V	V <sub>GS</sub> =0V, I <sub>S</sub> =200mA

\*Pulse Test : Pulse Width ≤ 380μs, Duty Cycle ≤ 2%

## Typical Characteristics

Typical Output Characteristics

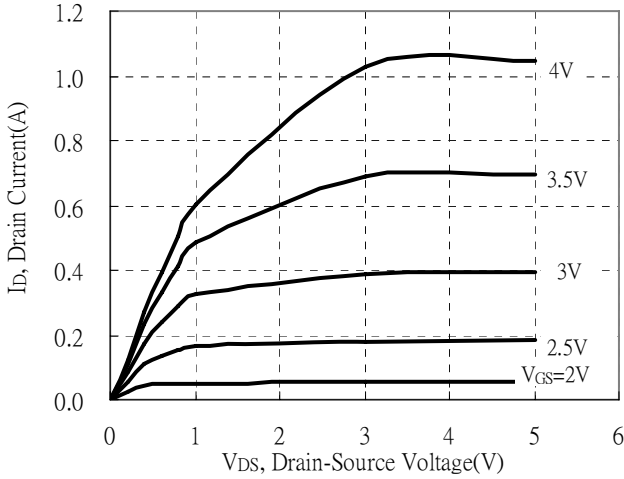

Typical Transfer Characteristics

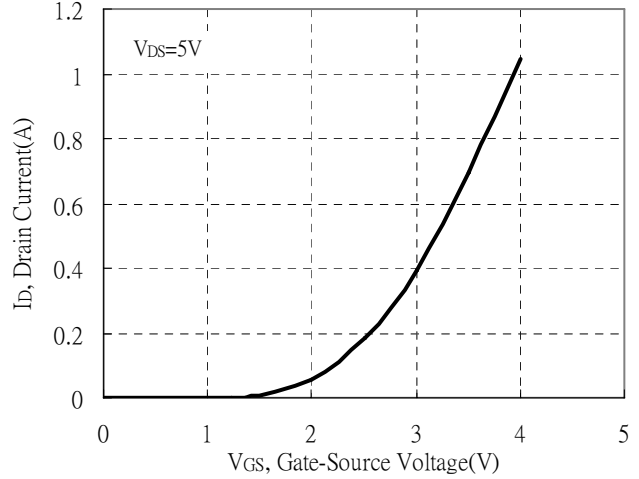

Static Drain-Source On-State resistance vs Drain Current

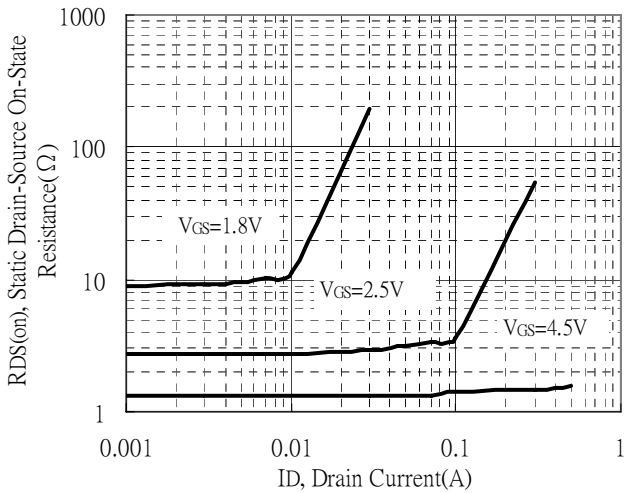

Reverse Drain Current vs Source-Drain Voltage

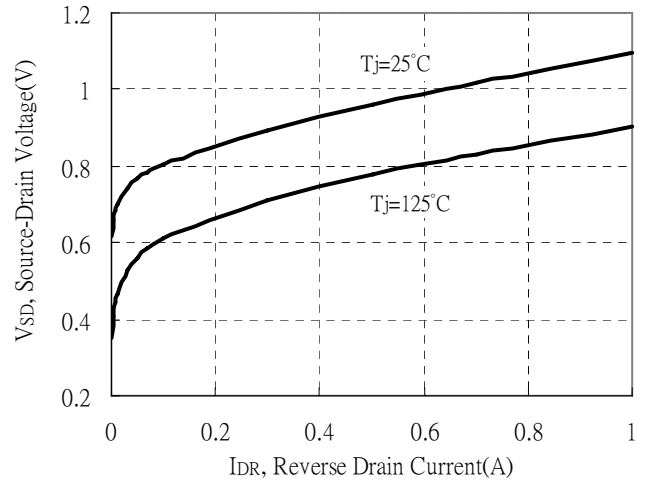

Static Drain-Source On-State Resistance vs Gate-Source Voltage

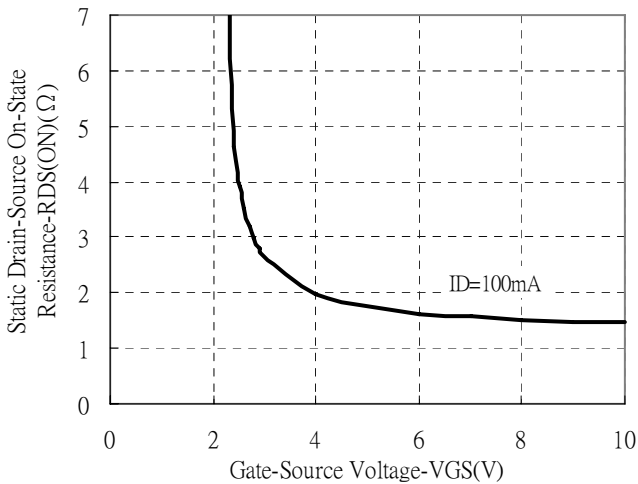

Drain-Source On-State Resistance vs Junction Temperature

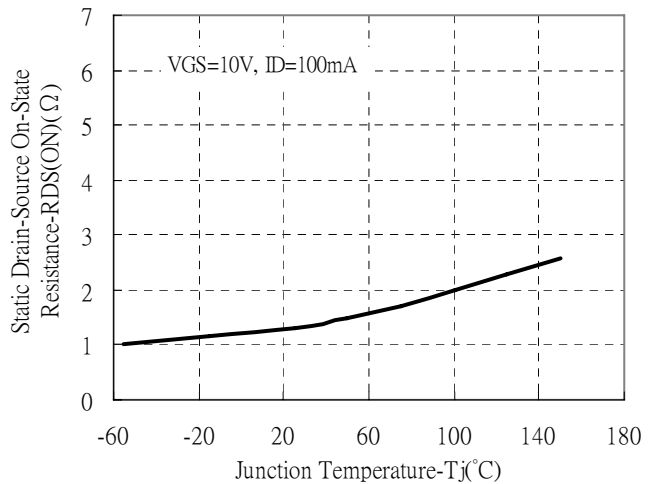



**Characteristic Curves(Cont.)**

Capacitance vs Drain-to-Source Voltage

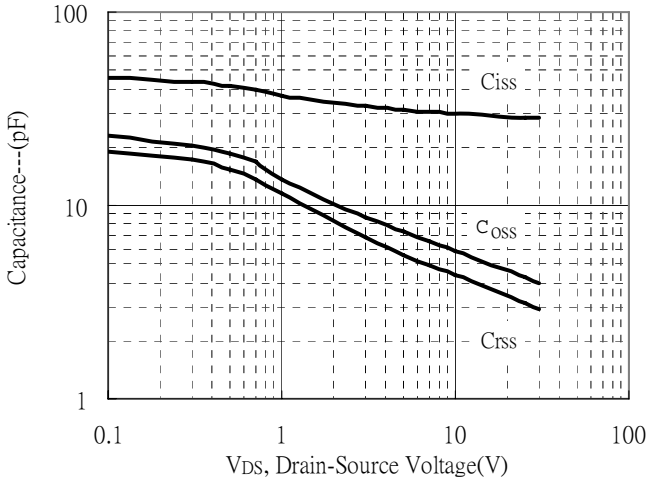

Threshold Voltage vs Junction Temperature

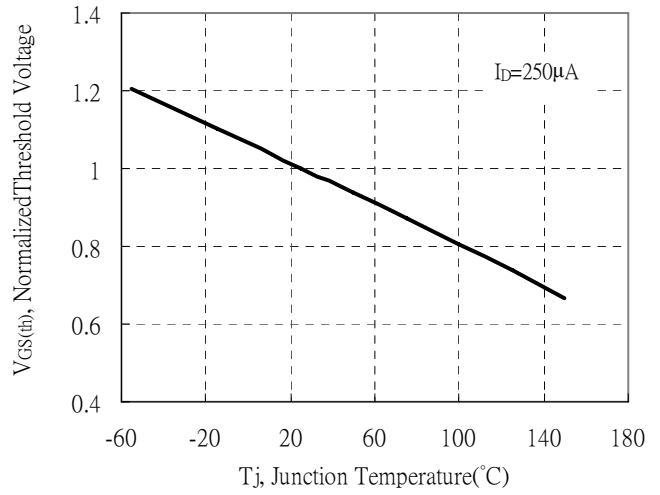

Forward Transfer Admittance vs Drain Current

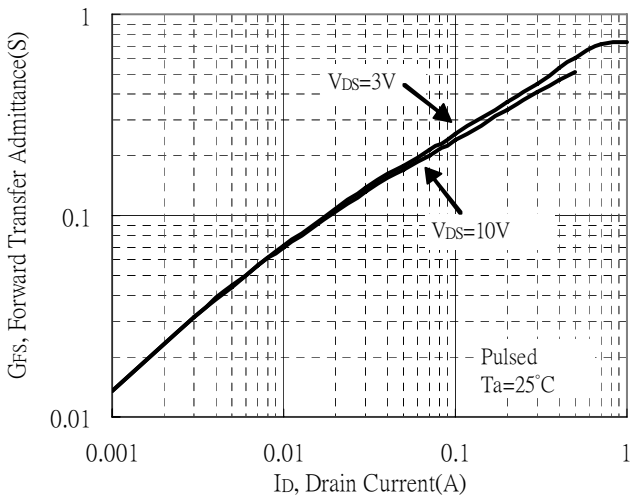

Brekdown Voltage vs Ambient Temperature

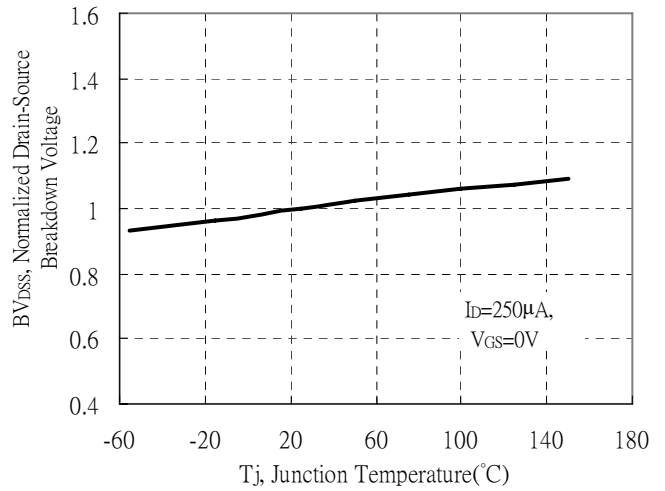

Power Derating Curve

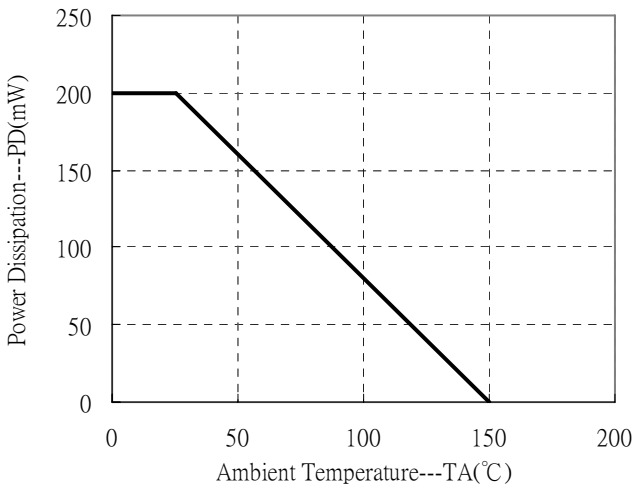

**Reel Dimension**

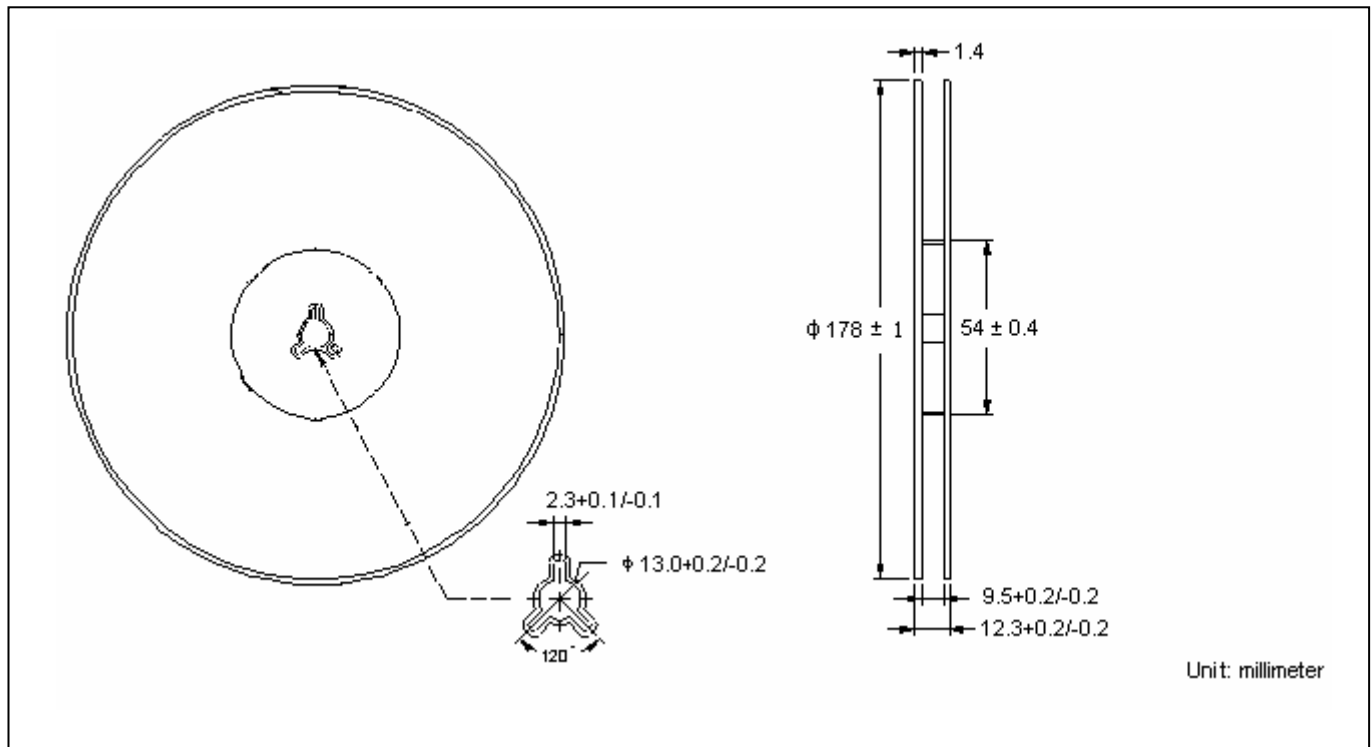

**Carrier Tape Dimension**

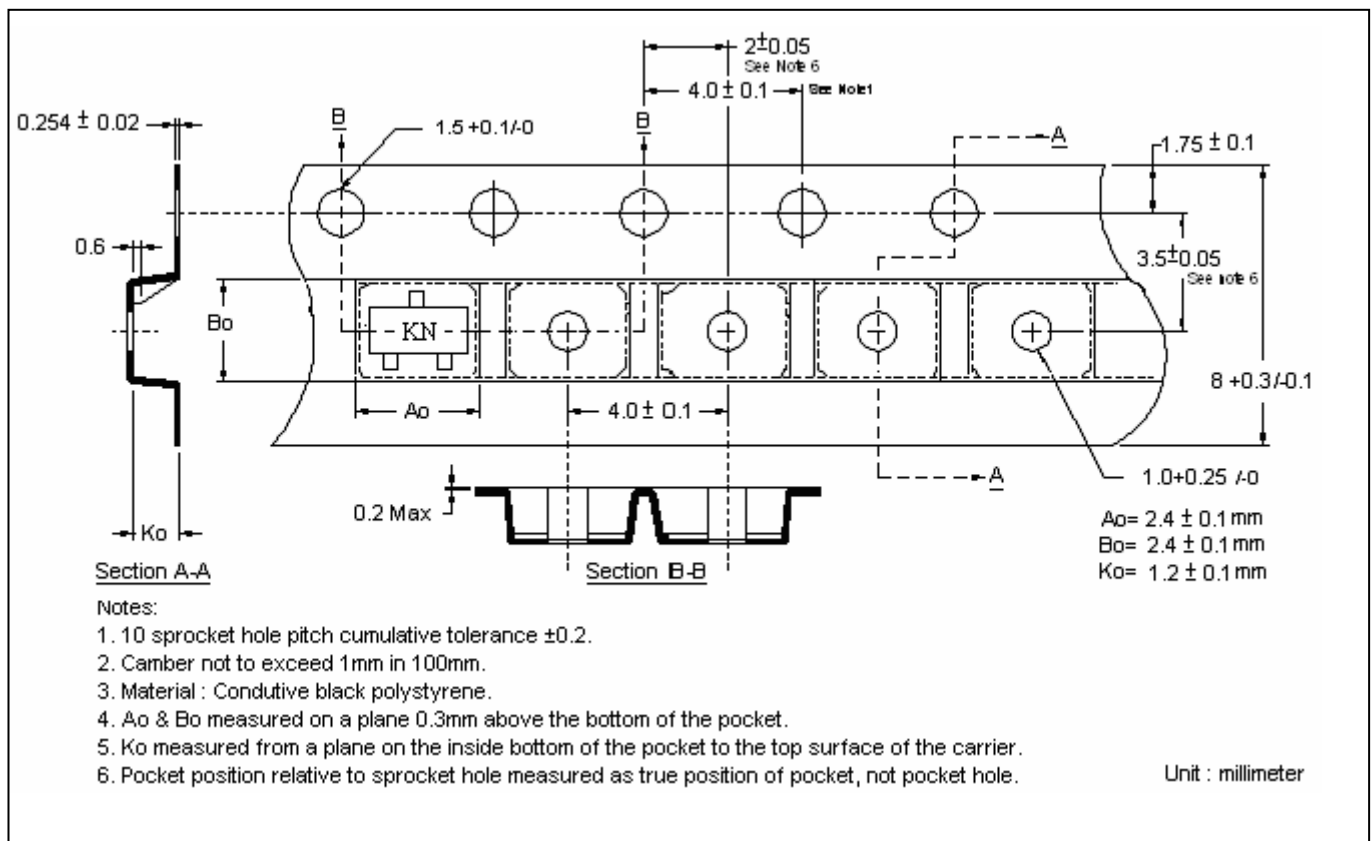

**Recommended wave soldering condition**

Product	Peak Temperature	Soldering Time
Pb-free devices	260 +0/-5 °C	5 +1/-1 seconds

**Recommended temperature profile for IR reflow**

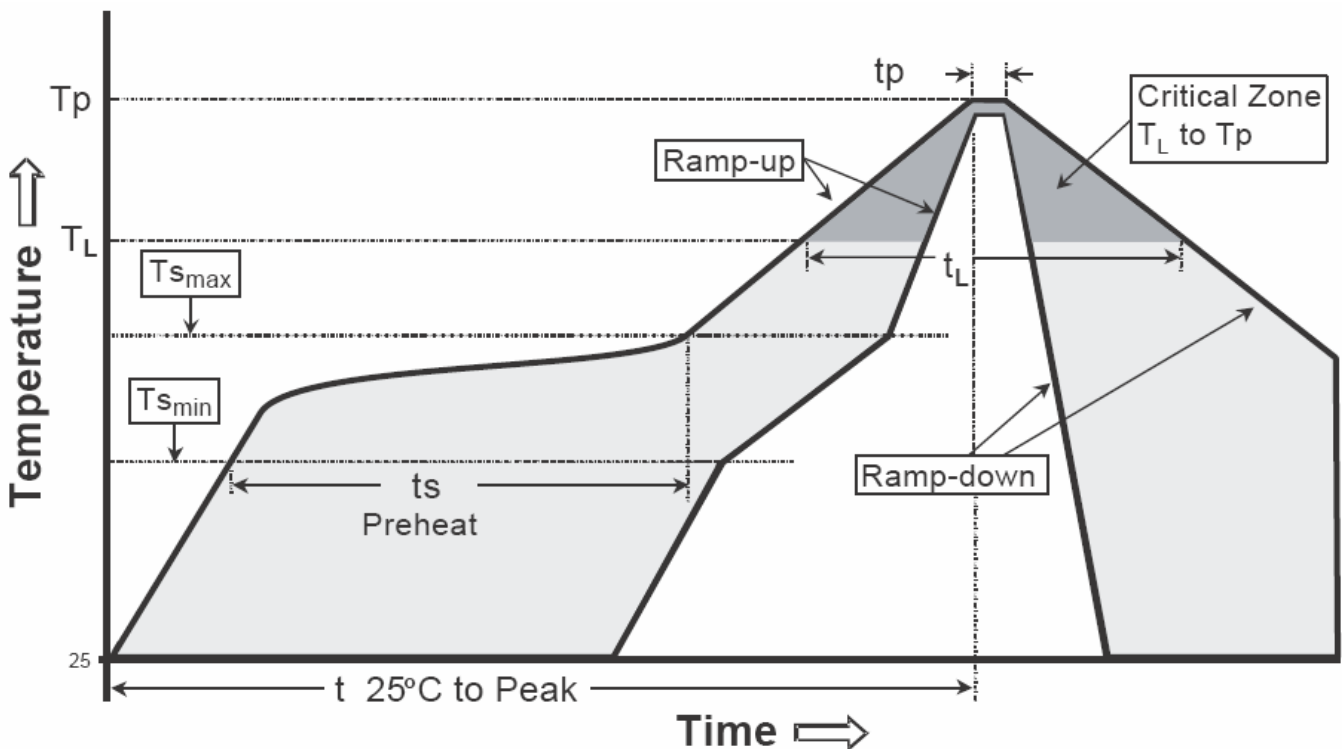

Profile feature	Sn-Pb eutectic Assembly	Pb-free Assembly
Average ramp-up rate (T <sub>s</sub> max to T <sub>p</sub> )	3°C/second max.	3°C/second max.
Preheat		
-Temperature Min(T <sub>s</sub> min)	100°C	150°C
-Temperature Max(T <sub>s</sub> max)	150°C	200°C
-Time(t <sub>s</sub> min to t <sub>s</sub> max)	60-120 seconds	60-180 seconds
Time maintained above:		
-Temperature (T <sub>L</sub> )	183°C	217°C
- Time (t <sub>L</sub> )	60-150 seconds	60-150 seconds
Peak Temperature(T <sub>p</sub> )	240 +0/-5 °C	260 +0/-5 °C
Time within 5°C of actual peak temperature(t <sub>p</sub> )	10-30 seconds	20-40 seconds
Ramp down rate	6°C/second max.	6°C/second max.
Time 25 °C to peak temperature	6 minutes max.	8 minutes max.

Note : All temperatures refer to topside of the package, measured on the package body surface.

**SOT-323 Dimension**

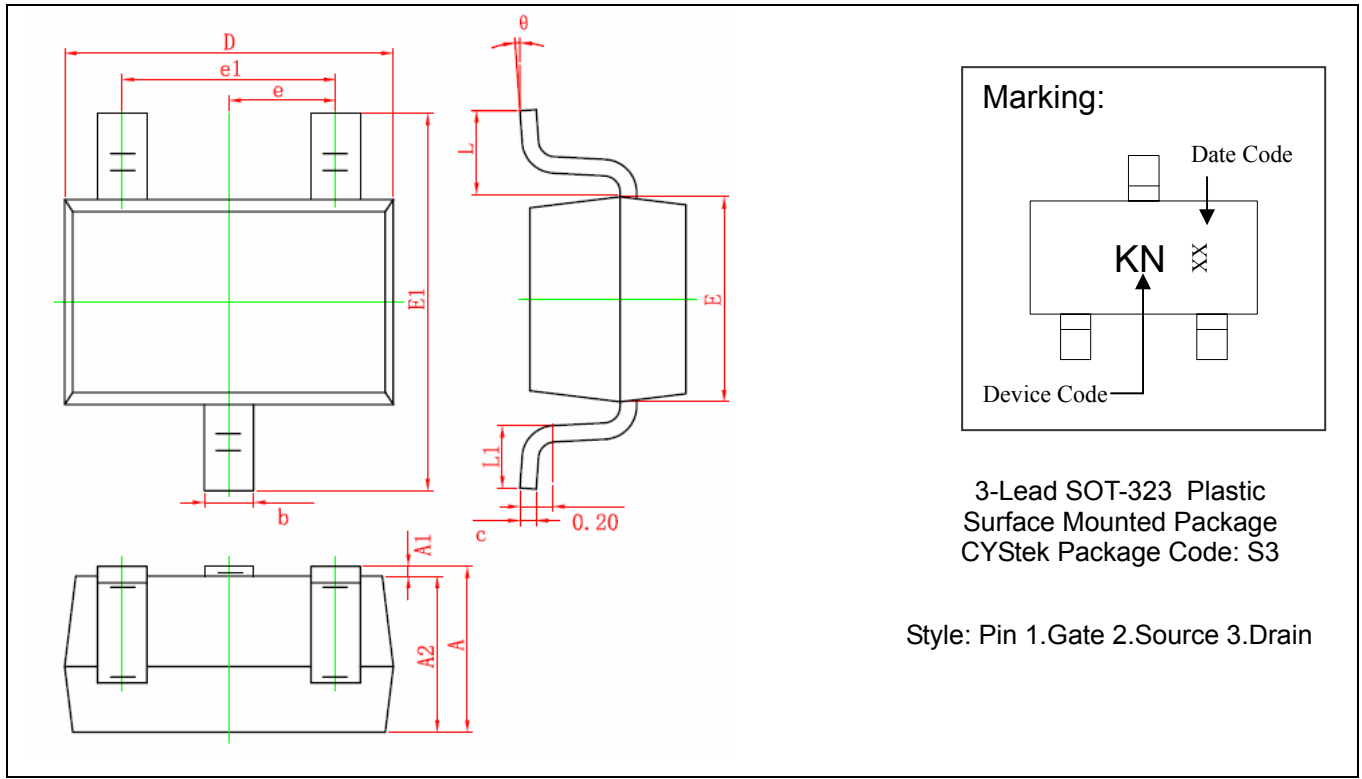

DIM	Millimeters		Inches		DIM	Millimeters		Inches	
	Min.	Max.	Min.	Max.		Min.	Max.	Min.	Max.
A	0.900	1.100	0.035	0.043	E1	2.150	2.450	0.085	0.096
A1	0.000	0.100	0.000	0.004	e	0.650	TYP	0.026	TYP
A2	0.900	1.000	0.035	0.039	e1	1.200	1.400	0.047	0.055
b	0.200	0.400	0.008	0.016	L	0.525	REF	0.021	REF
c	0.080	0.150	0.003	0.006	L1	0.260	0.460	0.010	0.018
D	2.000	2.200	0.079	0.087	θ	0°	8°	0°	8°
E	1.150	1.350	0.045	0.053					

**Notes:** 1.Controlling dimension: millimeters.  
 2.Maximum lead thickness includes lead finish thickness, and minimum lead thickness is the minimum thickness of base material.  
 3.If there is any question with packing specification or packing method, please contact your local CYStek sales office.

**Material:**

- Lead: Pure tin plated.
- Mold Compound: Epoxy resin family, flammability solid burning class: UL94V-0.

**Important Notice:**

- All rights are reserved. Reproduction in whole or in part is prohibited without the prior written approval of CYStek.
- CYStek reserves the right to make changes to its products without notice.
- CYStek **semiconductor products are not warranted to be suitable for use in Life-Support Applications, or systems.**
- CYStek assumes no liability for any consequence of customer product design, infringement of patents, or application assistance.