

**NAIS****RF (Radio Frequency)  
C × R 10 Type**  
(by)**PhotoMOS  
RELAYS**

&lt;R type&gt;

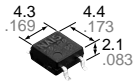
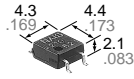

&lt;C type&gt;

mm inch

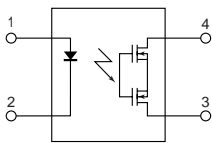
**FEATURES****1. Two option package available.**

R type offers greatly reduced on-resistance.

C type offers lower output capacitance.

|                       | AQY221R2S<br>(R type) | AQY221N2S<br>(C type) |
|-----------------------|-----------------------|-----------------------|
| Output capacitance: C | 13pF                  | 1pF                   |
| On resistance: R      | 0.8Ω                  | 9.5Ω                  |

**2. High speed switching**

Turn on time: 30μs (AQY221N2S)

Turn off time: 30μs (AQY221N2S)

**3. Super miniature design**

SOP 4-pin type.

**4. Low-level off state leakage current of 10pA**

The SSR has an off state leakage current of several milliamperes, where as this PhotoMOS relay has only 10pA (typical) even with the rated load voltage (AQY221N2S)

**TYPICAL  
APPLICATIONS****Measuring and testing equipment****1. Testing equipment for semiconductor performance**

IC tester, Liquid crystal driver tester, semiconductor performance tester

**2. Board tester**

Bare board tester, In-circuit tester, function tester

**3. Medical equipment**

Ultrasonic wave diagnostic machine

**4. Multi-point recorder**

Warping, thermo couple

**TYPES**

| Circuit arrangement | Type   | Output rating* |              | Tape and reel packing style  |                              | Packing quantity          |
|---------------------|--------|----------------|--------------|------------------------------|------------------------------|---------------------------|
|                     |        | Load voltage   | Load current | Picked from the 1/2-pin side | Picked from the 3/4-pin side |                           |
| 1 Form A            | R type | 40 V           | 250 mA       | AQY221R2SX                   | AQY221R2SZ                   | Tape and reel: 1,000 pcs. |
|                     | C type | 40 V           | 120 mA       | AQY221N2SX                   | AQY221N2SZ                   |                           |

\* Indicate the peak AC and DC values.

Notes:

(1) Tape package is the standard packing style. Also available in tube.

(Part No. suffix "X" or "Z" is not needed when ordering; Tube: 100 pcs.; Case: 2,000 pcs.)

(2) For space reasons, the initial letters of the product number "AQY and S", the package type indicator "X" and "Z" are omitted from the seal.

**RATING****1. Absolute maximum ratings (Ambient temperature: 25°C 77°F)**

| Item                    |                         | Symbol            | AQY221R2S<br>(R type)           | AQY221N2S<br>(C type) | Remarks                              |
|-------------------------|-------------------------|-------------------|---------------------------------|-----------------------|--------------------------------------|
| Input                   | LED forward current     | I <sub>F</sub>    | 50mA                            |                       |                                      |
|                         | LED reverse voltage     | V <sub>R</sub>    | 3V                              |                       |                                      |
|                         | Peak forward current    | I <sub>FP</sub>   | 1A                              |                       | f=100 Hz, Duty factor=0.1%           |
|                         | Power dissipation       | P <sub>in</sub>   | 75mW                            |                       |                                      |
| Output                  | Load voltage (peak AC)  | V <sub>L</sub>    | 40V                             |                       |                                      |
|                         | Continuous load current | I <sub>L</sub>    | 0.25A                           | 0.12A                 | Peak AC,DC                           |
|                         | Peak load current       | I <sub>peak</sub> | 0.75A                           | 0.30A                 | 100 ms (1 shot), V <sub>L</sub> = DC |
|                         | Power dissipation       | P <sub>out</sub>  | 300mW                           |                       |                                      |
| Total power dissipation |                         | P <sub>T</sub>    | 350mW                           |                       |                                      |
| I/O isolation voltage   |                         | V <sub>iso</sub>  | 500V AC                         | 1,500V AC             |                                      |
| Temperature limits      | Operating               | T <sub>opr</sub>  | -40°C to +85°C -40°F to +185°F  |                       | Non-condensing at low temperatures   |
|                         | Storage                 | T <sub>stg</sub>  | -40°C to +100°C -40°F to +212°F |                       |                                      |

2. Electrical characteristics (Ambient temperature: 25°C 77°F)

| Item                     |                                  |                | Symbol            | AQY221R2S<br>(R type)                   | AQY221N2S<br>(C type) | Condition   |   |
|--------------------------|----------------------------------|----------------|-------------------|---|-----------------------|---|---|
| Input                    | LED operate current              | Typical        | I <sub>Fon</sub>  | 0.5 mA                                  | 0.9 mA                | I <sub>L</sub> = 250 mA (R type)<br>I <sub>L</sub> = 80 mA (C type)   |   |
|                          |                                  | Maximum        |                   | 3.0 mA                                  |                       |   |   |
|                          | LED turn off current             | Minimum        | I <sub>Foff</sub> | 0.1 mA                                  | 0.2 mA                | I <sub>L</sub> = 250 mA (R type)<br>I <sub>L</sub> = 80 mA (C type)   |   |
|                          |                                  | Typical        |                   | 0.4 mA                                  | 0.85 mA               |   |   |
|                          | LED dropout voltage              | Typical        | V <sub>F</sub>    | 1.14 V(1.25 V at I <sub>F</sub> = 50mA) |                       | I <sub>F</sub> = 5 mA   |   |
|                          |                                  | Maximum        |                   | 1.5 V                                   |                       |   |   |
| Output                   | On resistance                    | Typical        | R <sub>on</sub>   | 0.8Ω                                    | 9.5Ω                  | I <sub>F</sub> = 5 mA<br>I <sub>L</sub> = 250 mA (R type),<br>I <sub>L</sub> = 80 mA (C type)<br>Within 1 s on time |   |
|                          |                                  | Maximum        |                   | 1.25Ω                                   | 12.5Ω                 |   |   |
|                          | Output capacitance               | Typical        | C <sub>out</sub>  | 13 pF                                   | 1.0 pF                | I <sub>F</sub> = 0<br>V <sub>B</sub> = 0 V<br>f = 1 MHz   |   |
|                          |                                  | Maximum        |                   | 18 pF                                   | 1.5 pF                |   |   |
|                          | Off state leakage current        | Typical        | I <sub>Leak</sub> | 0.03 nA                                 | 0.01 nA               | I <sub>F</sub> = 0<br>V <sub>L</sub> = Max.   |   |
|                          |                                  | Maximum        |                   | 10 nA                                   |                       |   |   |
| Transfer characteristics | Switching speed                  | Turn on time*  | T <sub>on</sub>   | Typical                                 | 0.1 ms                | 0.03 ms   | I <sub>F</sub> = 5 mA<br>V <sub>L</sub> = 10 V<br>R <sub>L</sub> = 40Ω (R type),<br>125Ω (C type) |
|                          |                                  |                |                   | Maximum                                 | 0.5ms                 |   |   |
|                          |                                  | Turn off time* | T <sub>off</sub>  | Typical                                 | 0.06ms                | 0.03ms  |   |
|                          |                                  |                |                   | Maximum                                 | 0.2 ms                |   |   |
|                          | I/O capacitance                  | Typical        | C <sub>iso</sub>  | 0.8 pF                                  |                       | f = 1MHz<br>V <sub>B</sub> = 0  |   |
|                          |                                  | Maximum        |                   | 1.5 pF                                  |                       |   |   |
|                          | Initial I/O isolation resistance | Minimum        | R <sub>iso</sub>  | 1,000MΩ                                 |                       | 500V DC   |   |

Note: Recommendable LED forward current I<sub>F</sub> = 5 mA.  
For type of connection, see Page 6

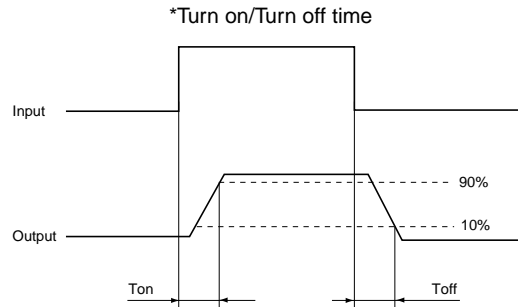

REFERENCE DATA

1. Load current vs. ambient temperature characteristics

Allowable ambient temperature: -40°C to +85°C  
-40°F to +185°F

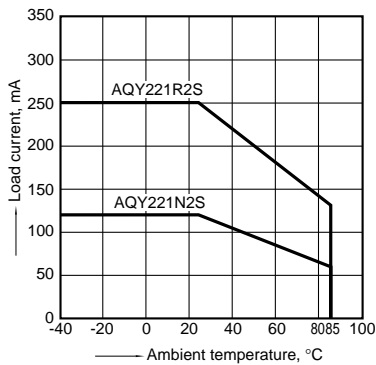

2. Load current vs. Load voltage characteristics

Ambient temperature: 25°C 77°F

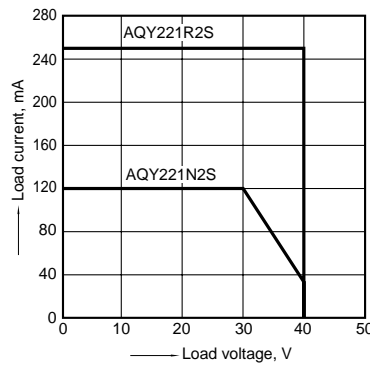

3. On resistance vs. ambient temperature characteristics

Measured portion: between terminals 3 and 4  
LED current: 5 mA; Load voltage: Max. (DC);  
Load current: 250mA (DC) [R type], 80mA (DC) [C type];

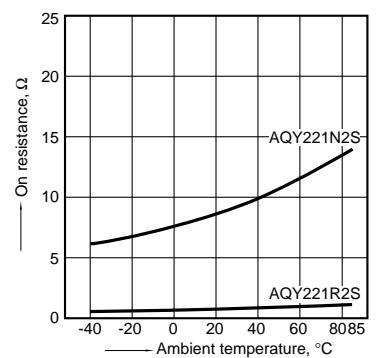

# AQY221○2S

## 4. Turn on time vs. ambient temperature characteristics

Measured portion: between terminals 3 and 4  
LED current: 5 mA; Load voltage: 10V (DC);  
Continuous load current: 250mA (DC) [R type], 80mA (DC) [C type];

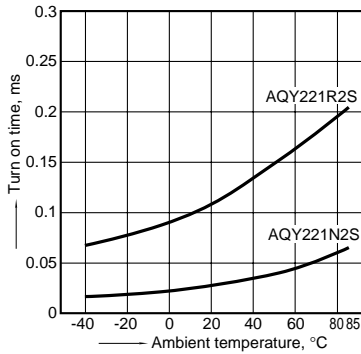

## 5. Turn off time vs. ambient temperature characteristics

LED current: 5 mA; Load voltage: 10V (DC);  
Continuous load current: 250mA (DC) [R type], 80mA (DC) [C type];

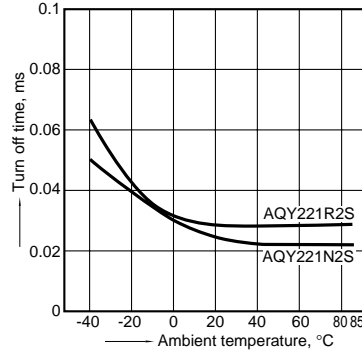

## 6. LED operate current vs. ambient temperature characteristics

Load voltage: Max. (DC);  
Continuous load current: 250mA (DC) [R type], 80mA (DC) [C type];

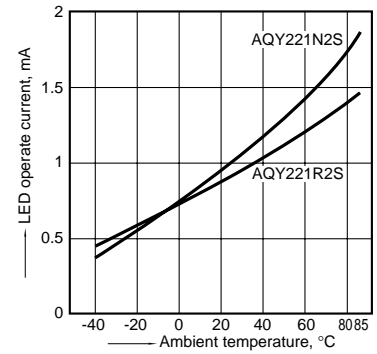

## 7. LED turn off current vs. ambient temperature characteristics

Load voltage: Max. (DC);  
Continuous load current: 250mA (DC) [R type], 80mA (DC) [C type];

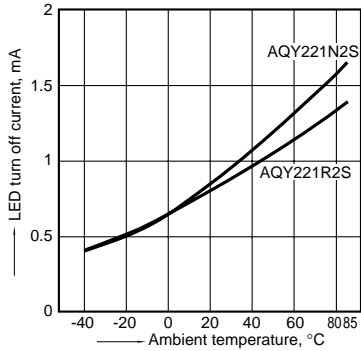

## 8. LED dropout voltage vs. ambient temperature characteristics

LED current: 5 to 50 mA

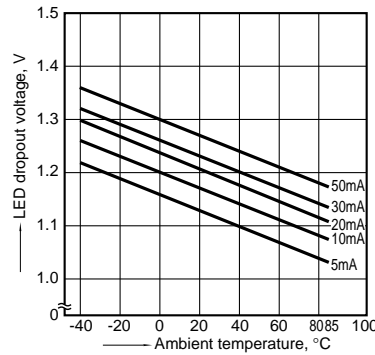

## 9. Voltage vs. current characteristics of output at MOS portion

Measured portion: between terminals 3 and 4  
Ambient temperature: 25°C 77°F

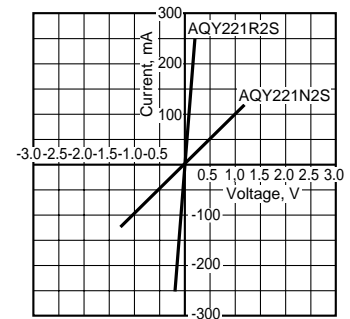

## 10. Off state leakage current

Measured portion: between terminals 3 and 4  
Ambient temperature: 25°C 77°F

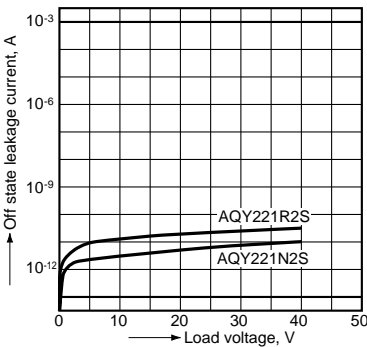

## 11. LED forward current vs. turn on time characteristics

Measured portion: between terminals 3 and 4  
Load voltage: 10V (DC);  
Continuous load current: 250mA (DC) [R type], 80mA (DC) [C type];  
Ambient temperature: 25°C 77°F

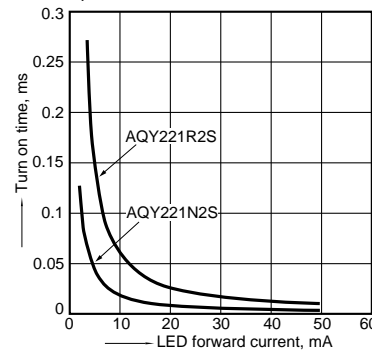

## 12. LED forward current vs. turn off time characteristics

Measured portion: between terminals 3 and 4  
Load voltage: 10V (DC);  
Continuous load current: 250mA (DC) [R type], 80mA (DC) [C type];  
Ambient temperature: 25°C 77°F

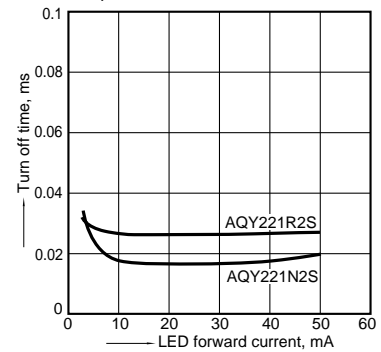

## 13. Applied voltage vs. output capacitance characteristics

Measured portion: between terminals 3 and 4  
Frequency: 1 MHz, 30m Vrms; Ambient temperature: 25°C 77°F

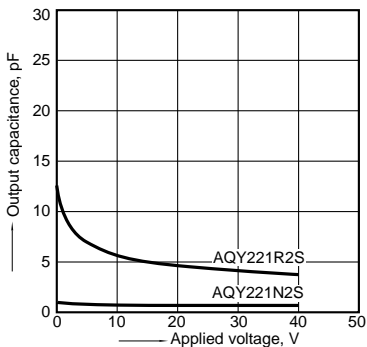

## 14. Isolation characteristics (50Ω impedance)

Measured portion: between terminals 3 and 4  
Ambient temperature: 25°C 77°F

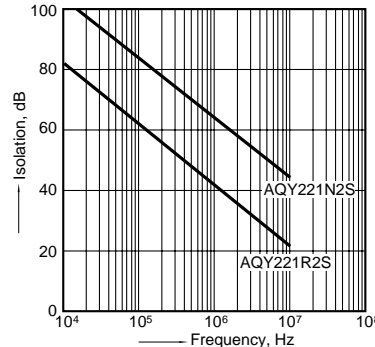

## 15. Insertion loss characteristics (50Ω impedance)

Measured portion: between terminals 3 and 4  
Ambient temperature: 25°C 77°F

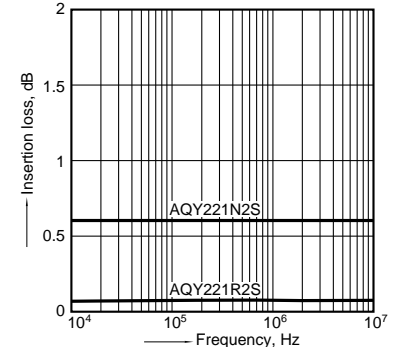

16-(1). On resistance distribution (R type)  
 Measured portion: between terminals 3 and 4  
 Continuous load current: 250mA (DC)  
 Ambient temperature: 25°C 77°F

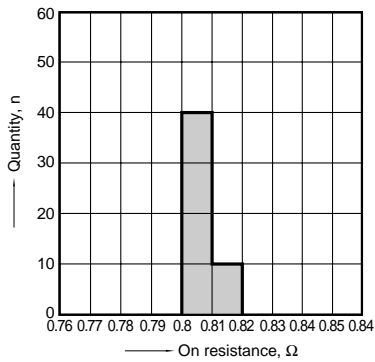

16-(2). On resistance distribution (C type)  
 Measured portion: between terminals 3 and 4  
 Continuous load current: 80mA (DC)  
 Ambient temperature: 25°C 77°F

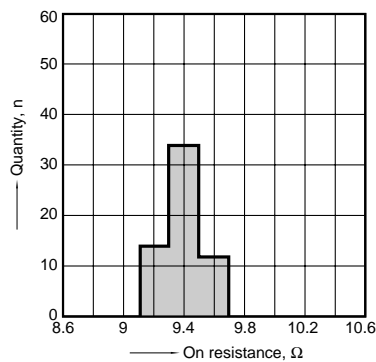

17-(1). Turn on time distribution (R type)  
 Load voltage: 10V (DC)  
 Continuous load current: 250mA (DC)  
 Ambient temperature: 25°C 77°F

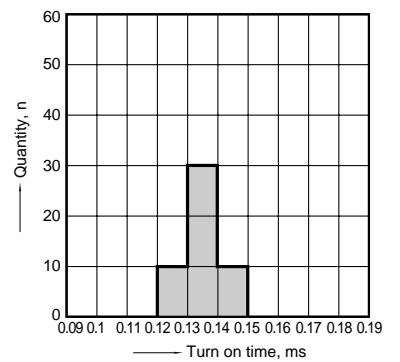

17-(2). Turn on time distribution (C type)  
 Load voltage: 10V (DC)  
 Continuous load current: 80mA (DC)  
 Ambient temperature: 25°C 77°F

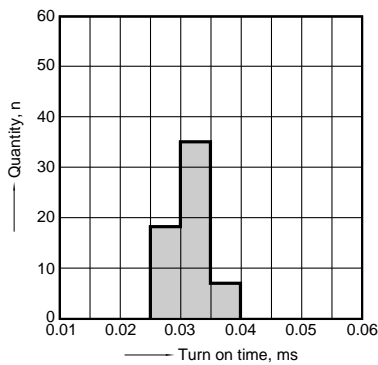

18-(1). Turn off time distribution (R type)  
 Load voltage: 10V (DC)  
 Continuous load current: 250mA (DC)  
 Ambient temperature: 25°C 77°F

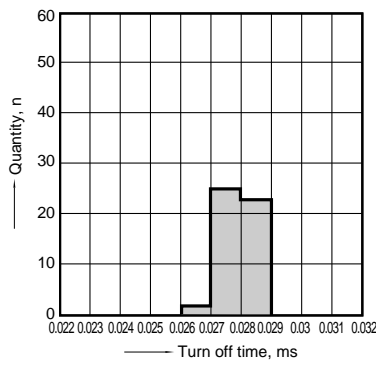

18-(2). Turn off time distribution (C type)  
 Load voltage: 10V (DC)  
 Continuous load current: 80mA (DC)  
 Ambient temperature: 25°C 77°F

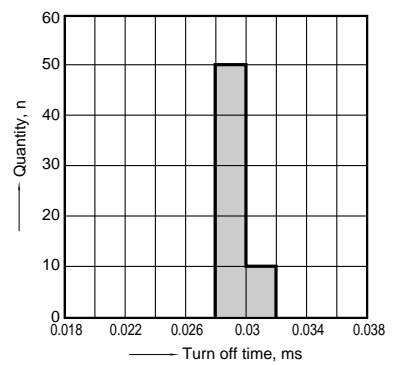

19-(1). LED operate current distribution (R type)  
 Load voltage: 10V (DC)  
 Continuous load current: 250mA (DC)  
 Ambient temperature: 25°C 77°F

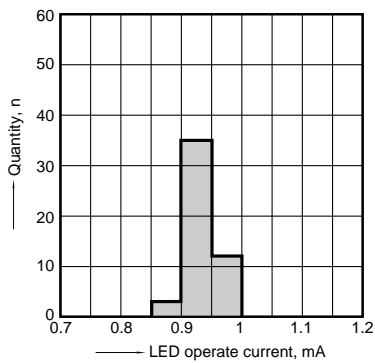

19-(2). LED operate current distribution (C type)  
 Load voltage: 10V (DC)  
 Continuous load current: 80mA (DC)  
 Ambient temperature: 25°C 77°F

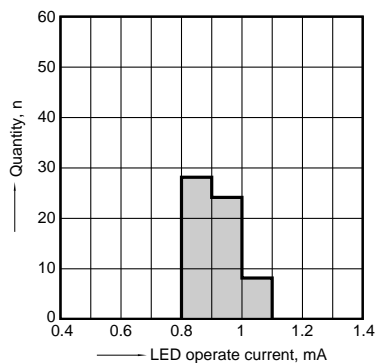

**DIMENSIONS**

mm inch

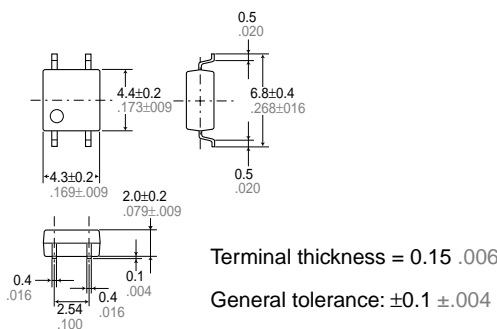

Recommended mounting pad (TOP VIEW)

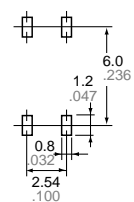

Tolerance: ±0.1 ±.004

## SCHEMATIC AND WIRING DIAGRAMS

•  $E_I$ : Power source at input side;  $V_{IN}$ : Input voltage;  $I_F$ : LED forward current;  $I_{IN}$ : Input current;  $V_L$ : Load voltage;  $I_L$ : Load current

| Schematic | Output configuration | Load  | Wiring diagram |
|-----------|----------------------|-------|----------------|
|           | 1a                   | AC/DC |                |

## CAUTIONS FOR USE

### 1. Short across terminals

Do not short circuit between terminals when relay is energized. There is possibility of breaking the internal IC.

### 2. Surge voltages at the input

If reverse surge voltages are present at the input terminals, connect a diode in reverse parallel across the input terminals and keep the reverse voltages below the reverse breakdown voltage.

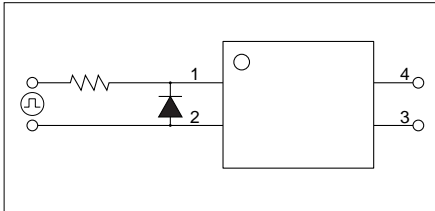

### 3. Recommended LED forward current ( $I_F$ )

It is recommended that the LED forward current ( $I_F$ ) be kept at 5mA.

### 4. Ripple in the input power supply

If ripple is present in the input power supply, observe the following:

- 1) For LED operate current at  $E_{min}$ , maintain the value mentioned in the table of "Note 3. Recommended LED forward current ( $I_F$ )."
- 2) Keep the LED operate current at 50 mA or less at  $E_{max}$ .

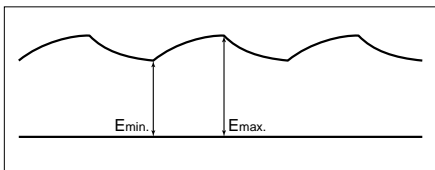

### 5. Output spike voltages

1) If an inductive load generates spike voltages which exceed the absolute maximum rating, the spike voltage must be limited.

Typical circuits are shown below.

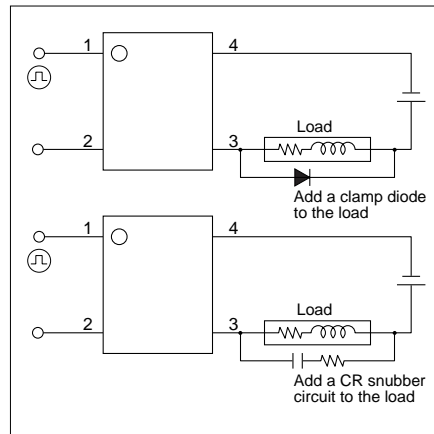

2) If spike voltages generated at the load are limited with a clamp diode and the circuit wires are long, spike voltages will occur by inductance. Keep wires as short as possible to minimize inductance.

### 6. Cleaning solvents compatibility

Dip cleaning with an organic solvent is recommended for removal of solder flux, dust, etc. Select a cleaning solvent from the following table. If ultrasonic cleaning is used, the severity of factors such as frequency, output power and cleaning solvent selected may cause loose wires and other defects. Make sure these conditions are correct before use. For details, please consult us.

| Cleaning solvent | Compatibility (○: Yes X: No)  |   |
|------------------|---|---|
| Chlorine base    | <ul style="list-style-type: none"> <li>• Trichlene</li> <li>• Chloroethylene</li> </ul>             | ○ |
| Aqueous          | <ul style="list-style-type: none"> <li>• Indusco</li> <li>• Hollis</li> <li>• Lonco Terg</li> </ul> | ○ |
| Alcohol base     | <ul style="list-style-type: none"> <li>• IPA</li> <li>• Ethanol</li> </ul>                          | ○ |
| Others           | <ul style="list-style-type: none"> <li>• Thinner</li> <li>• Gasoline</li> </ul>                     | X |

### 7. Input wiring pattern

This relays, avoid installing the input (LED side) wiring pattern to the bottom side of the package if you require the specified I/O isolation voltage ( $V_{iso}$ ) after mounting the PC board. Since part of the frame on the output side is exposed, it may cause fluctuations in the I/O isolation voltage.

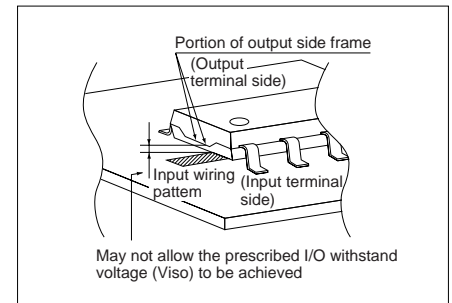

**8. Soldering**

When soldering this terminals, the following conditions are recommended.

(1) IR (Infrared reflow) soldering method

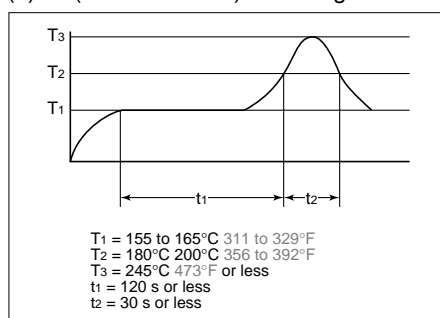

(2) Vapor phase soldering method

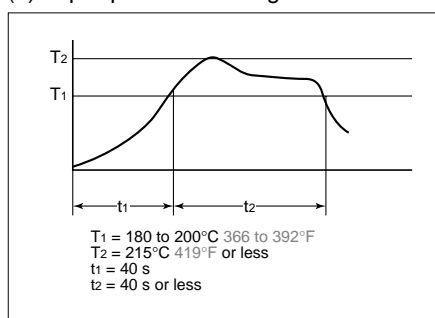

(3) Double wave soldering method

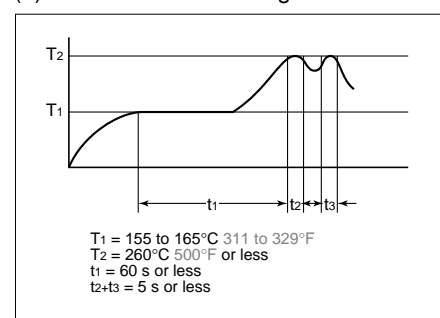

(4) Soldering iron method

Tip temperature: 280 to 300°C 536 to 572 °F

Wattage: 30 to 60 W

Soldering time: within 5 s

(5) Others

Check mounting conditions before using other soldering methods (hot-air, hot plate, pulse heater, etc.)

- The temperature profile indicates the temperature of the soldered terminal on the surface of the PC board. The ambient

temperature may increase excessively. Check the temperature under mounting conditions.

- The conditions for the infrared reflow soldering apply when preheating using the VPS method.

**9. The following shows the packaging format**

1) Tape and reel

| Type                  | Tape dimensions   | Dimensions of paper tape reel |
|-----------------------|---|-------------------------------|
| SO package 4-pin type | <p>                     (1) When picked from 1/2-pin side: Part No. AQY○○○SX (Shown above)<br/>                     (2) When picked from 3/4-pin side: Part No. AQY○○○SZ                 </p> |                               |

2) Tube

(1) Devices are packaged in a tube so pin No. 1 is on the stopper B side. Observe correct orientation when mounting them on PC boards.

(SOP type)

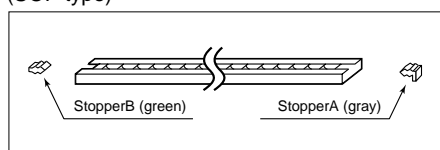

2) Storage

PhotoMOS relays implemented in SO packages are sensitive to moisture and come in sealed moisture-proof packages. Observe the following cautions on storage.

- After the moisture-proof package is unsealed, take the devices out of storage as soon as possible (within 1 month at the most).
- If the devices are to be left in storage for a considerable period after the moisture-proof package has been unsealed, it is recommended to keep them in another moisture-proof bag containing silica gel (within 3 months at the most).

**10. Transportation and storage**

1) Extreme vibration during transport will warp the lead or damage the relay. Han-

dle the outer and inner boxes with care. 2) Storage under extreme conditions will cause soldering degradation, external appearance defects, and deterioration of the characteristics. The following storage conditions are recommended:

- Temperature: 0 to 45°C 32 to 113°F
- Humidity: Less than 70% R.H.
- Atmosphere: No harmful gasses such as sulfurous acid gas, minimal dust.

**11. Applying stress that exceeds the absolute maximum rating**

If the voltage or current value for any of the terminals exceeds the absolute maximum rating, internal elements will deteriorate because of the excessive voltage or current. In extreme cases, wiring may melt, or silicon P/N junctions may be destroyed.

As a result, the design should ensure that the absolute maximum ratings will never be exceeded, even momentarily. (Use at 15 VDC or lower and 9 VAC or lower is recommended.)

**12. Deterioration and destruction caused by discharge of static electricity**

This phenomenon is generally called static electricity destruction. This occurs when static electricity generated by various factors is discharged while the relay terminals

are in contact. The result can produce internal destruction of the element.

To prevent problems from static electricity, the following precautions and measures should be taken when using your device.

- 1) Employees handling relays should wear anti-static clothing and should be grounded through protective resistance of 500 kΩ to 1 MΩ.
- 2) A conductive metal sheet should be placed over the work table. Measuring instruments and jigs should be grounded.
- 3) When using soldering irons, either use irons with low leakage current, or ground the tip of the soldering iron. (Use of low-voltage soldering irons is also recommended.)
- 4) Devices and equipment used in assembly should also be grounded.
- 5) When packing printed circuit boards and equipment, avoid using high-polymer materials such as foam styrene, plastic, and other materials which carry an electrostatic charge.
- 6) When storing or transporting relays, the environment should not be conducive to generating static electricity (for instance, the humidity should be between 45 and 60%). Relays should always be protected by using non-conductive packing materials.