



SANYO Semiconductors

DATA SHEET

An ON Semiconductor Company

TND027SW — ExPD(Excellent Power Device) Lowside Power Switch Lamp-, Solenoid-, and Motor-Driving Applications

Features

- N-channel MOSFET built in
- Overheat protection (Self recovery type)
- Overcurrent protection (Self recovery type current limiting function)
- Overvoltage protection
- Incorporates two sets of circuit

Specifications

Absolute Maximum Ratings at Ta=25°C

Parameter	Symbol	Conditions	Ratings	Unit
Drain-to-Source Voltage	V _{DS}		60	V
Output Current	I _{O(DC)}		1.5	A
Input Voltage	V _{IN}		-0.3 to +10	V
Allowable Power Dissipation	P _D	When mounted on ceramic substrate (1200mm ² ×0.8mm) lunit	1.3	W
		When mounted on ceramic substrate (1200mm ² ×0.8mm)	1.7	W
Operating Supply Voltage	V _{DS(opr)}		40	V
Operating Temperature	T _{opr}		-40 to +85	°C
Junction Temperature	T _j		150	°C
Storage Temperature	T _{stg}		-55 to +150	°C

Package Dimensions

unit : mm (typ)

7005A-005

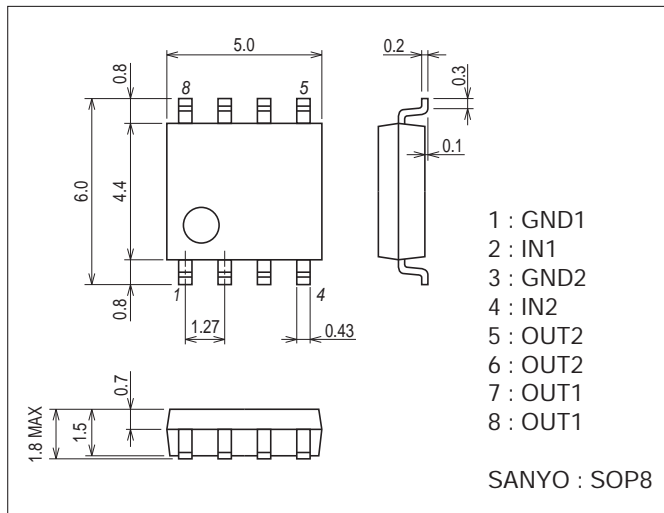

Product & Package Information

- Package : SOP8
- JEITA, JEDEC : SC-87, SOT-96
- Minimum Packing Quantity : 1,000 pcs./reel

Packing Type: TL

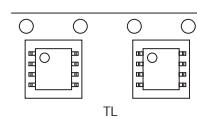

Marking

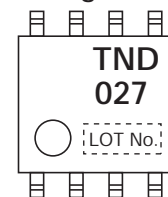

Block Diagram

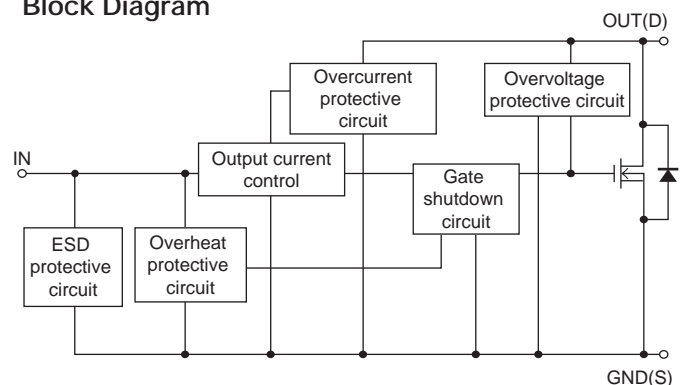

SANYO Semiconductor Co., Ltd.

<http://semicon.sanyo.com/en/network>

TND027SW

Electrical Characteristics at Ta=25°C

Parameter	Symbol	Conditions	Ratings			Unit
			min	typ	max	
Drain-to-Source Clamp Voltage	$V_{DS, clamp}$	$V_{IN}=0V, I_O=1mA$	60			V
Output-OFF Current	I_{DSS1}	$V_{IN}=0V, V_{DS}=50V$			10	μA
	I_{DSS2}	$V_{IN}=0V, V_{DS}=12V$			5	μA
Input Threshold Voltage	$V_{IN(th)}$	$V_{DS}=5V, I_O=1mA$	1.0	1.5	2.0	V
Protection Circuit Operating Input Voltage	$V_{IN(opr)}$		4		10	V
Drain-to-Source ON Resistance	$R_{DS(on)}$	$V_{IN}=5V, I_O=1A$		0.3	0.4	Ω
Input Current (Output On)	I_{IN}	$V_{IN}=5V$			0.6	mA
Over-Heat Detecting Temperature	$T_{j(sd)}$	$V_{IN}=5V, I_O=1A$	120	150	190	$^{\circ}C$
Over-Current Detecting Current	I_s	$V_{IN}=5V$	3.0	6.0	9.0	A
Over-Current Limit (Peak)	I_{LMT}	$V_{IN}=5V$	3.0	6.0	9.0	A
Input Clamp Voltage	$V_{IN, clamp}$	$I_{IN}=1mA$	10			V

Notes : 1. Overcurrent protection circuit limits the output current to the range of overcurrent limit value.

2. During overheat protecting operation, output current is turned off.

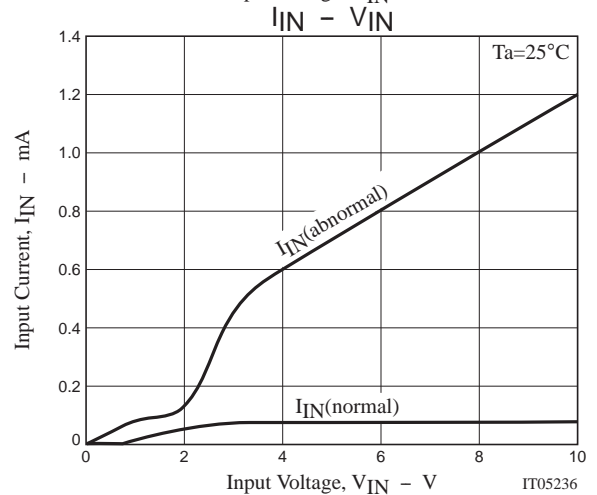
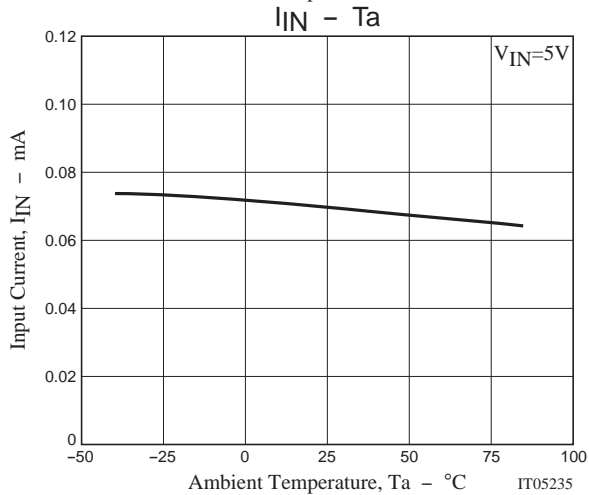
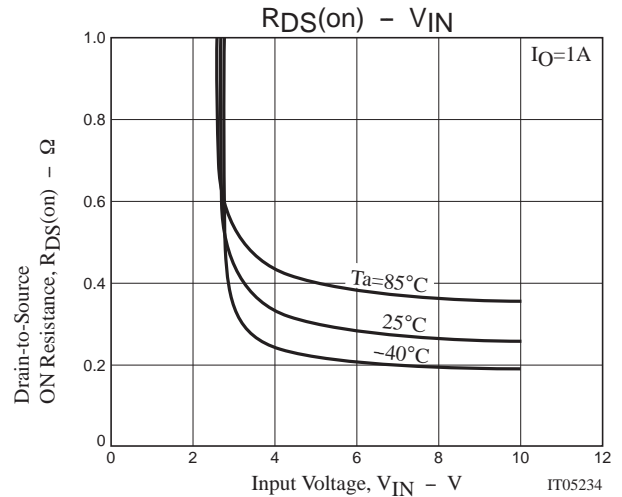
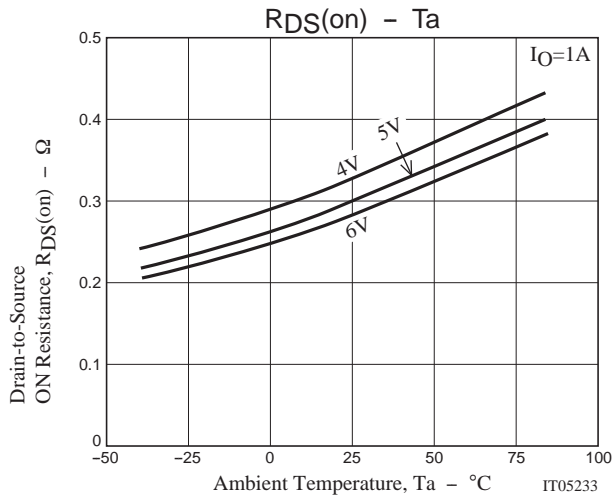

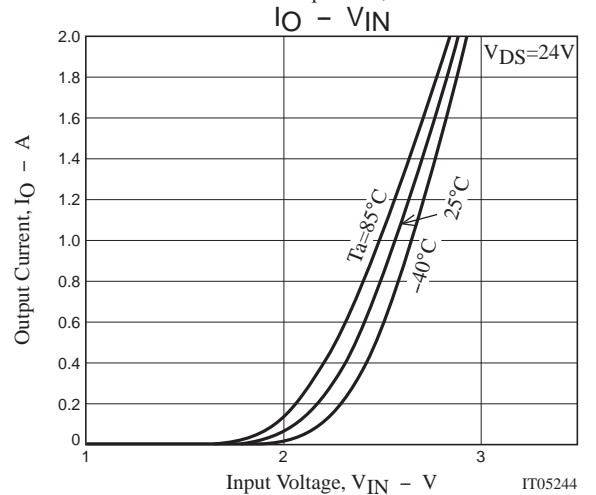
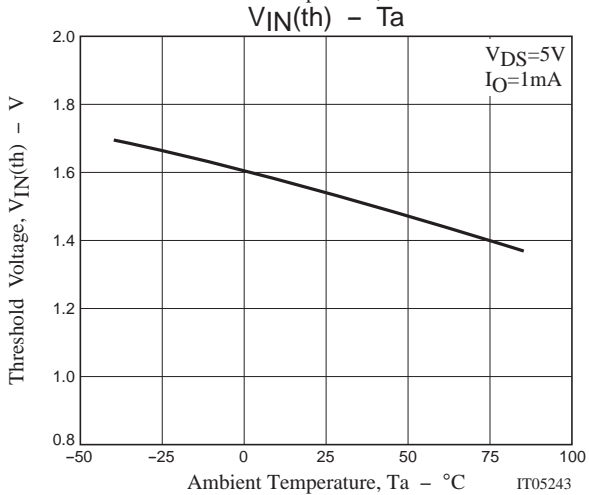
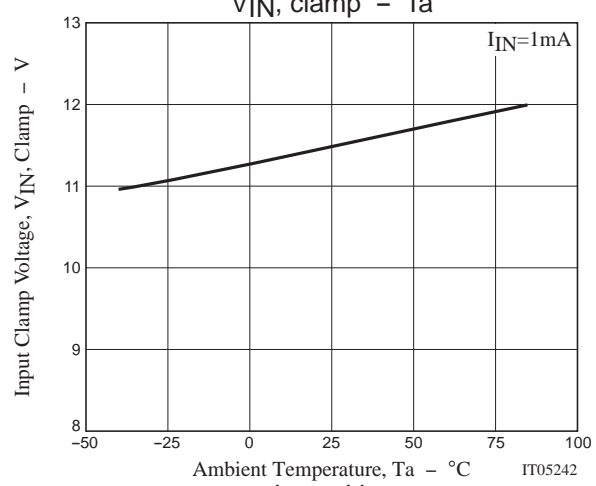
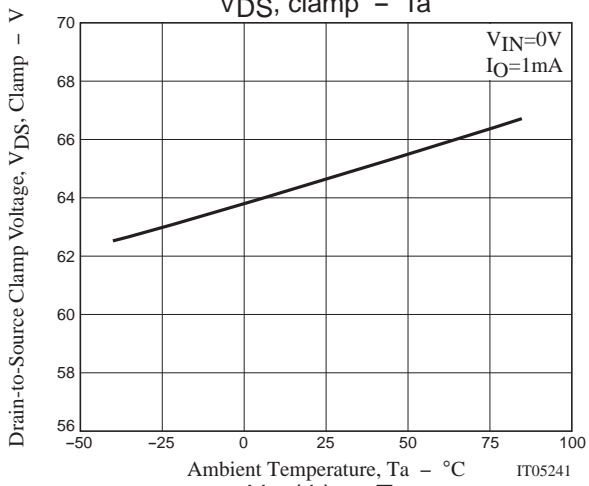
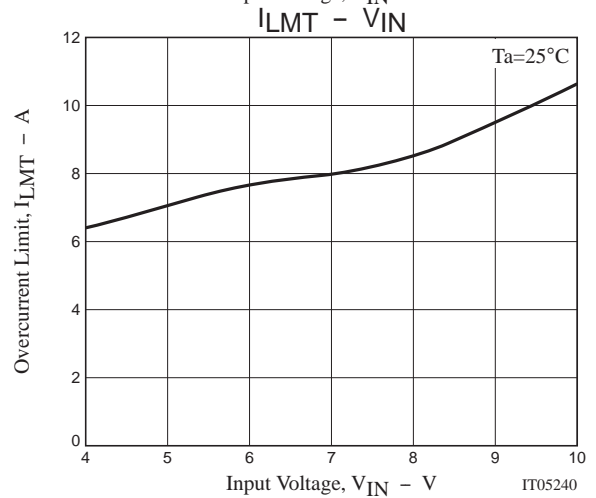
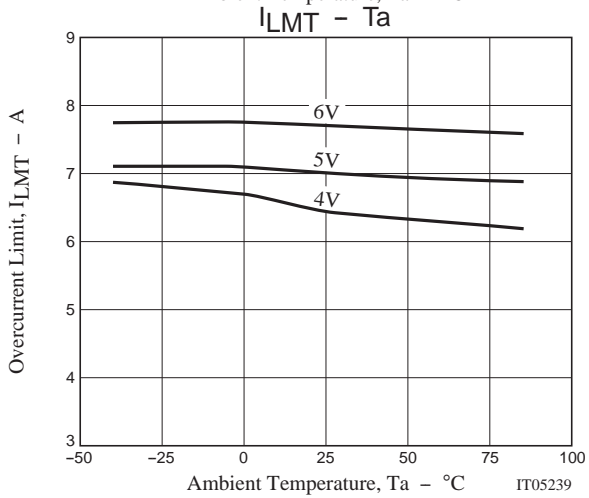
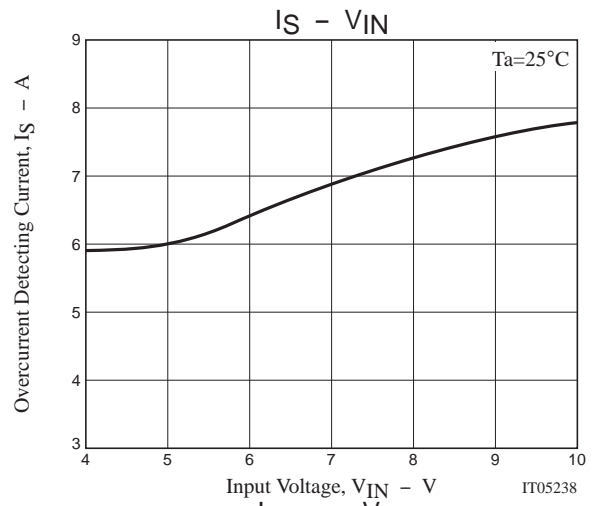
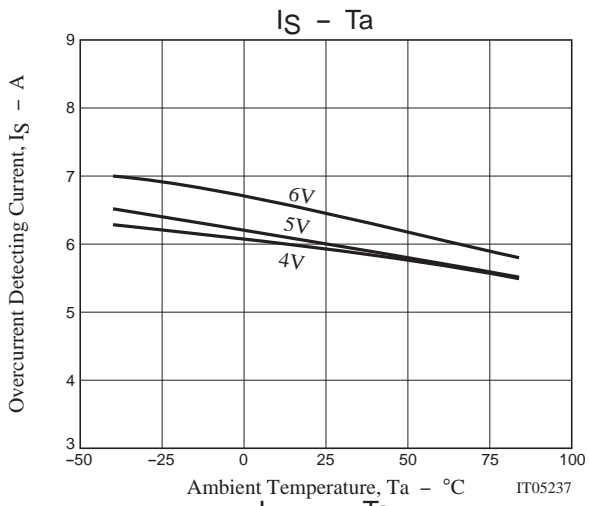

TND027SW

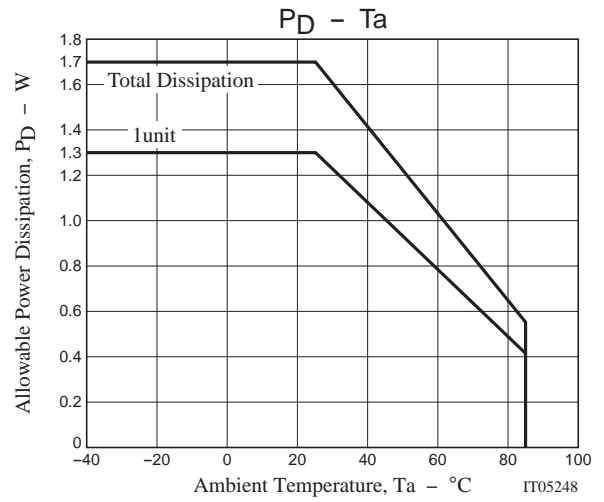
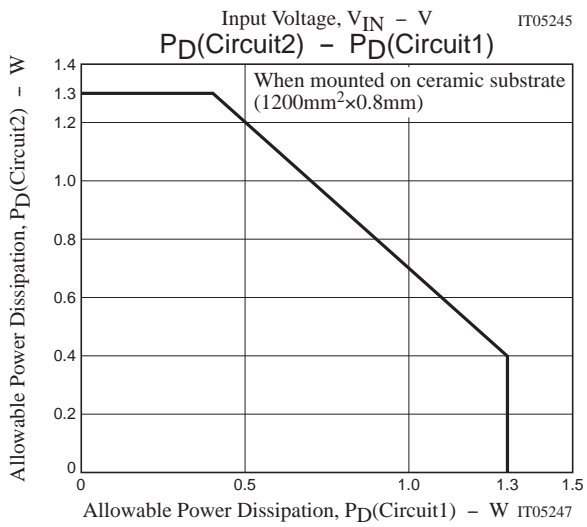
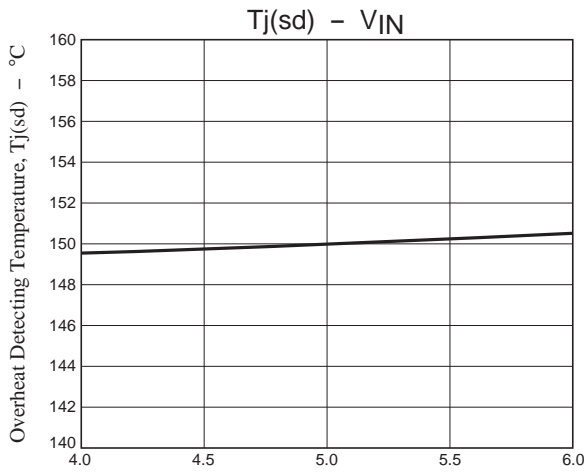

Sample Application Circuit

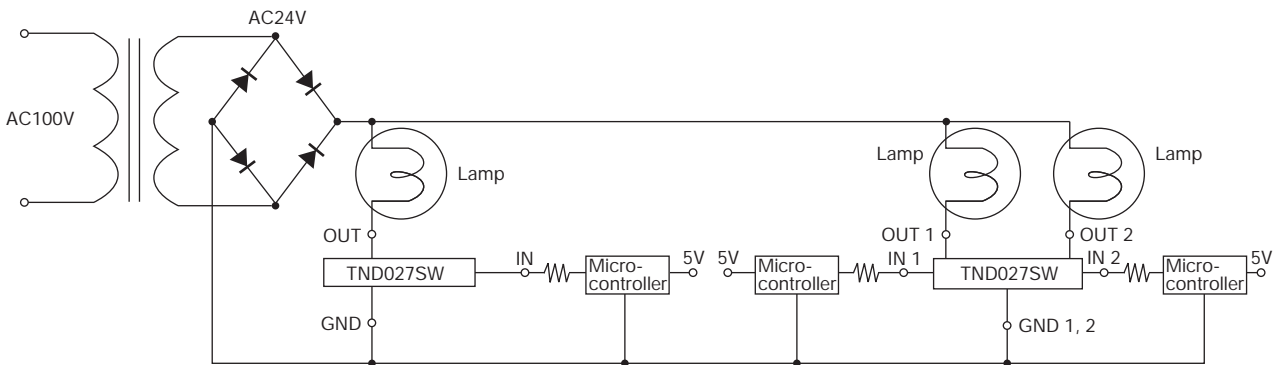

Another Sample Application Circuit (Solenoid drive)

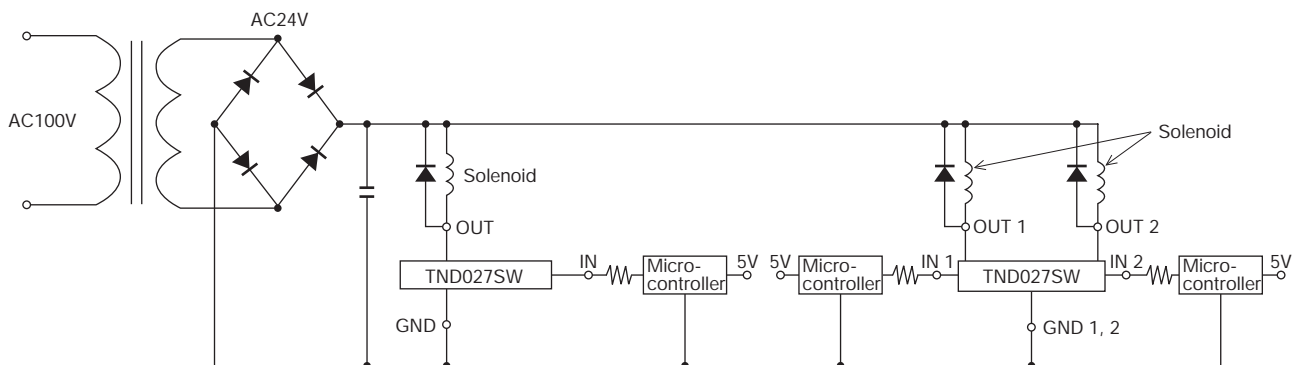

Operation Description

- The output power MOSFET will be turned on when the input voltage exceeds the input threshold voltage (4 to 6V is recommended), and then the lamp will be turned on by the current flowing to the lamp. Conversely, the output power MOSFET will be turned off when the input voltage goes below the input threshold voltage, and the lamp will be turned off.
- The inrush current that occurs during normal lamp operation is limited to a preset value by the built-in overcurrent protecting circuit, which makes the lamp life longer.
- The internal overcurrent protection function limits the current of output power MOSFET when output current of at least the overcurrent detecting current value flows at load short. Besides, if the device temperature exceeds the allowable power dissipation, overheat protection function protects the power switch from being broken down by turning off the current of output power MOSFET when T_j comes to 150°C (typical).
- As an example of application circuit, DC voltage can also be controlled as a solenoid drive.

Addition

- The diode between OUT and GND in the block diagram is parasitic diode of the MOSFET.
- Not apply a voltage on IN terminal during the period when OUT voltage is lower than GND voltage when driving a solenoid or a motor.
- Be sure connect a diode between OUT terminal and GND terminal when you want to apply a voltage on IN terminal under the above-stated state (that is, OUT Voltage < GND Voltage).

- Any and all SANYO Semiconductor Co.,Ltd. products described or contained herein are, with regard to "standard application", intended for the use as general electronics equipment. The products mentioned herein shall not be intended for use for any "special application" (medical equipment whose purpose is to sustain life, aerospace instrument, nuclear control device, burning appliances, transportation machine, traffic signal system, safety equipment etc.) that shall require extremely high level of reliability and can directly threaten human lives in case of failure or malfunction of the product or may cause harm to human bodies, nor shall they grant any guarantee thereof. If you should intend to use our products for new introduction or other application different from current conditions on the usage of automotive device, communication device, office equipment, industrial equipment etc. , please consult with us about usage condition (temperature, operation time etc.) prior to the intended use. If there is no consultation or inquiry before the intended use, our customer shall be solely responsible for the use.
- Specifications of any and all SANYO Semiconductor Co.,Ltd. products described or contained herein stipulate the performance, characteristics, and functions of the described products in the independent state, and are not guarantees of the performance, characteristics, and functions of the described products as mounted in the customer's products or equipment. To verify symptoms and states that cannot be evaluated in an independent device, the customer should always evaluate and test devices mounted in the customer's products or equipment.
- SANYO Semiconductor Co.,Ltd. assumes no responsibility for equipment failures that result from using products at values that exceed, even momentarily, rated values (such as maximum ratings, operating condition ranges, or other parameters) listed in products specifications of any and all SANYO Semiconductor Co.,Ltd. products described or contained herein.
- SANYO Semiconductor Co.,Ltd. strives to supply high-quality high-reliability products, however, any and all semiconductor products fail or malfunction with some probability. It is possible that these probabilistic failures or malfunction could give rise to accidents or events that could endanger human lives, trouble that could give rise to smoke or fire, or accidents that could cause damage to other property. When designing equipment, adopt safety measures so that these kinds of accidents or events cannot occur. Such measures include but are not limited to protective circuits and error prevention circuits for safe design, redundant design, and structural design.
- In the event that any or all SANYO Semiconductor Co.,Ltd. products described or contained herein are controlled under any of applicable local export control laws and regulations, such products may require the export license from the authorities concerned in accordance with the above law.
- No part of this publication may be reproduced or transmitted in any form or by any means, electronic or mechanical, including photocopying and recording, or any information storage or retrieval system, or otherwise, without the prior written consent of SANYO Semiconductor Co.,Ltd.
- Any and all information described or contained herein are subject to change without notice due to product/technology improvement, etc. When designing equipment, refer to the "Delivery Specification" for the SANYO Semiconductor Co.,Ltd. product that you intend to use.
- Upon using the technical information or products described herein, neither warranty nor license shall be granted with regard to intellectual property rights or any other rights of SANYO Semiconductor Co.,Ltd. or any third party. SANYO Semiconductor Co.,Ltd. shall not be liable for any claim or suits with regard to a third party's intellectual property rights which has resulted from the use of the technical information and products mentioned above.

This catalog provides information as of October, 2011. Specifications and information herein are subject to change without notice.