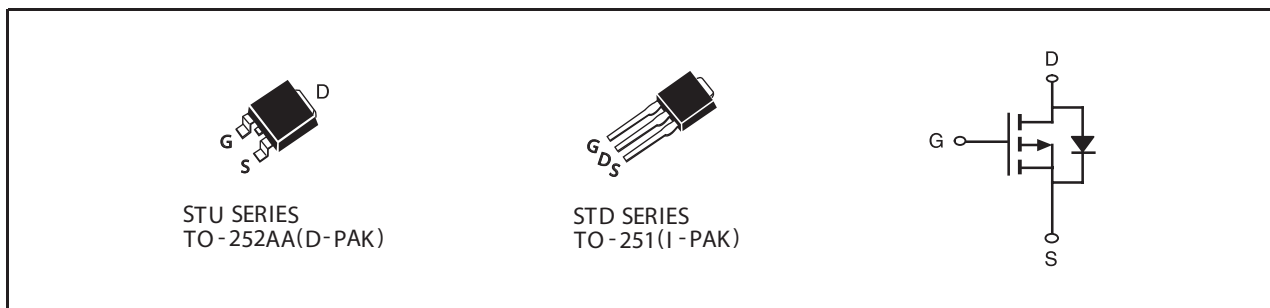

**P-Channel Logic Level Enhancement Mode Field Effect Transistor****PRODUCT SUMMARY**

| V _{DSS} | I _D | R _{DS(ON)} (mΩ) Typ |
|------------------|----------------|------------------------------|
| -40V | -43A | 14 @ V _{GS} =-10V |
| | | 23 @ V _{GS} =-4.5V |

FEATURES

- Super high dense cell design for low R_{DS(ON)}.
- Rugged and reliable.
- Surface Mount Package.

**ABSOLUTE MAXIMUM RATINGS (T_A=25°C unless otherwise noted)**

| Symbol | Parameter | Limit | Units |
|-----------------------------------|--|----------------------|-------|
| V _{DS} | Drain-Source Voltage | -40 | V |
| V _{GS} | Gate-Source Voltage | ±20 | V |
| I _D | Drain Current-Continuous ^a | T _C =25°C | -43 |
| | | T _C =70°C | -34.4 |
| I _{DM} | -Pulsed ^b | -130 | A |
| E _{AS} | Single Pulse Avalanche Energy ^d | 225 | mJ |
| P _D | Maximum Power Dissipation ^a | T _C =25°C | 42 |
| | | T _C =70°C | 27 |
| T _J , T _{STG} | Operating Junction and Storage Temperature Range | -55 to 150 | °C |

THERMAL CHARACTERISTICS

| | | | |
|-------------------|--|----|------|
| R _{θ JC} | Thermal Resistance, Junction-to-Case ^a | 3 | °C/W |
| R _{θ JA} | Thermal Resistance, Junction-to-Ambient ^a | 50 | °C/W |

STU/D417S

Ver 1.2

ELECTRICAL CHARACTERISTICS (TA=25°C unless otherwise noted)

| Symbol | Parameter | Conditions | Min | Typ | Max | Units |
|---|------------------------------------|---|------|------|------|-------|
| OFF CHARACTERISTICS | | | | | | |
| BV _{DSS} | Drain-Source Breakdown Voltage | V _{GS} =0V , I _D =-250uA | -40 | | | V |
| I _{DSS} | Zero Gate Voltage Drain Current | V _{DS} =-32V , V _{GS} =0V | | | 1 | uA |
| I _{GSS} | Gate-Body Leakage Current | V _{GS} = ±20V , V _{DS} =0V | | | ±100 | nA |
| ON CHARACTERISTICS | | | | | | |
| V _{GS(th)} | Gate Threshold Voltage | V _{DS} =V _{GS} , I _D =-250uA | -1.7 | -2 | -3 | V |
| R _{DS(ON)} | Drain-Source On-State Resistance | V _{GS} =-10V , I _D =-21.5A | | 14 | | m ohm |
| | | V _{GS} =-4.5V , I _D =-16.8A | | 23 | | m ohm |
| g _{FS} | Forward Transconductance | V _{DS} =-10V , I _D =-21.5A | | 44 | | S |
| DYNAMIC CHARACTERISTICS ° | | | | | | |
| C _{ISS} | Input Capacitance | V _{DS} =-20V, V _{GS} =0V f=1.0MHz | | 2620 | | pF |
| C _{OSS} | Output Capacitance | | | 360 | | pF |
| C _{RSS} | Reverse Transfer Capacitance | | | 265 | | pF |
| SWITCHING CHARACTERISTICS ° | | | | | | |
| t _{D(ON)} | Turn-On Delay Time | V _{DD} =-20V I _D =-1.0A V _{GS} =-10V R _{GEN} = 6 ohm | | 51 | | ns |
| t _r | Rise Time | | | 91 | | ns |
| t _{D(OFF)} | Turn-Off Delay Time | | | 325 | | ns |
| t _f | Fall Time | | | 112 | | ns |
| Q _g | Total Gate Charge | V _{DS} =-20V, I _D =-21.5A, V _{GS} =-10V | | 65 | | nC |
| | | V _{DS} =-20V, I _D =-21.5A, V _{GS} =-4.5V | | 31 | | nC |
| Q _{gs} | Gate-Source Charge | V _{DS} =-20V, I _D =-21.5A, V _{GS} =-10V | | 6.2 | | nC |
| Q _{gd} | Gate-Drain Charge | | | 19 | | nC |
| DRAIN-SOURCE DIODE CHARACTERISTICS | | | | | | |
| V _{SD} | Diode Forward Voltage ^b | V _{GS} =0V, I _S = -5A | | -0.8 | -1.3 | V |

Notes

- Surface Mounted on FR4 Board, t ≤ 10sec.
- Pulse Test: Pulse Width ≤ 300us, Duty Cycle ≤ 2%.
- Guaranteed by design, not subject to production testing.
- Starting T_J=25°C, L=0.5mH, V_{DD} = 20V .(See Figure13)

Aug,23,2010

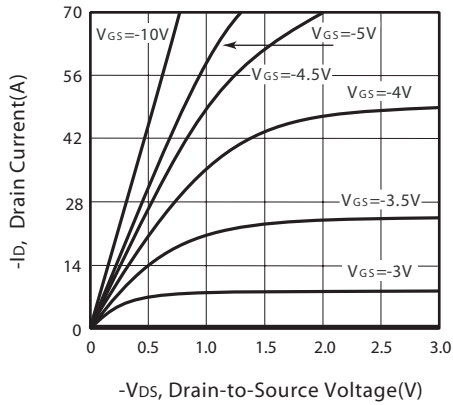

Figure 1. Output Characteristics

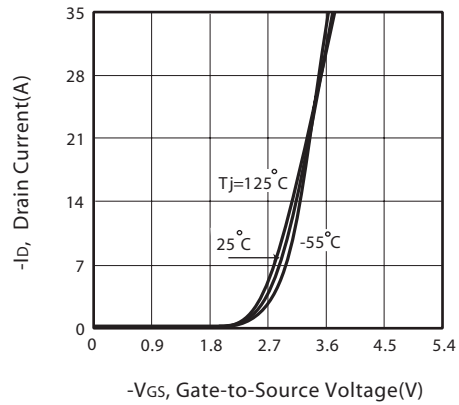

Figure 2. Transfer Characteristics

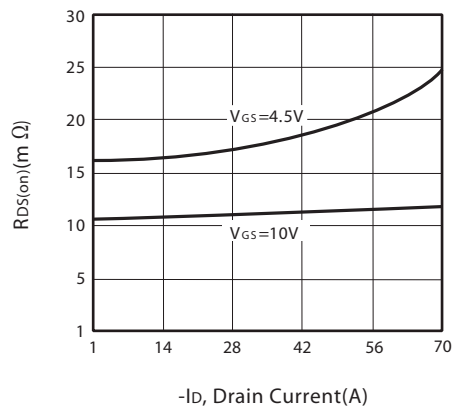

Figure 3. On-Resistance vs. Drain Current and Gate Voltage

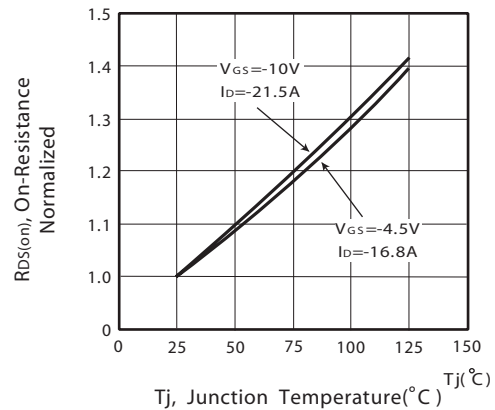

Figure 4. On-Resistance Variation with Drain Current and Temperature

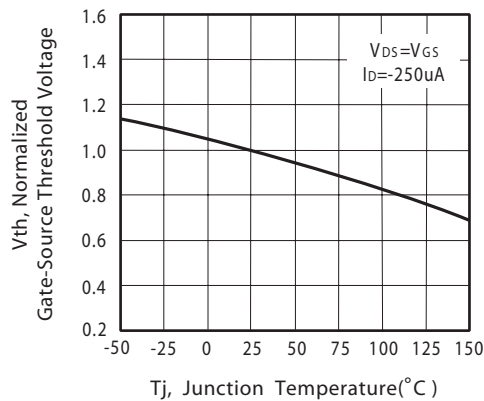

Figure 5. Gate Threshold Variation with Temperature

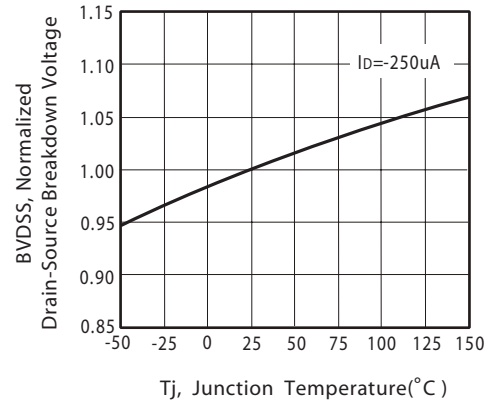

Figure 6. Breakdown Voltage Variation with Temperature

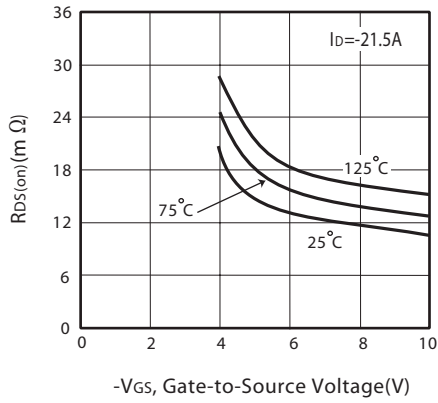

Figure 7. On-Resistance vs. Gate-Source Voltage

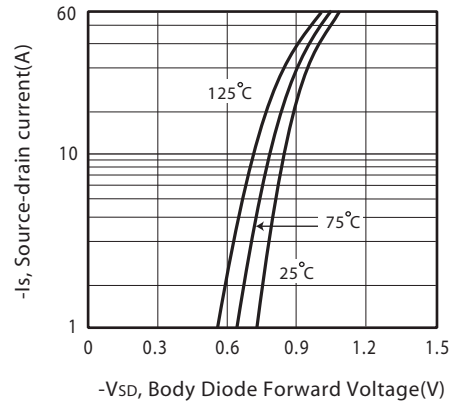

Figure 8. Body Diode Forward Voltage Variation with Source Current

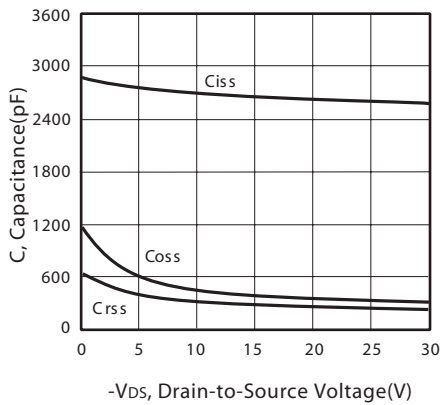

Figure 9. Capacitance

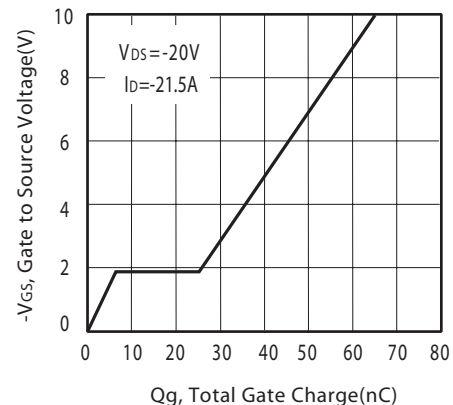

Figure 10. Gate Charge

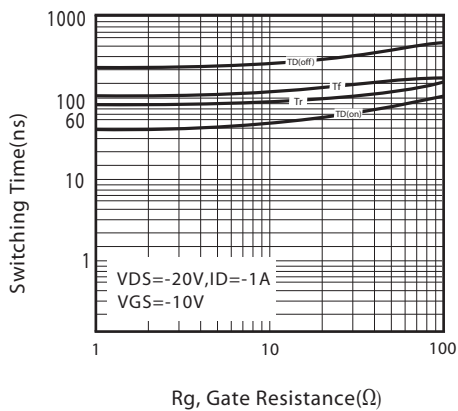

Figure 11. switching characteristics

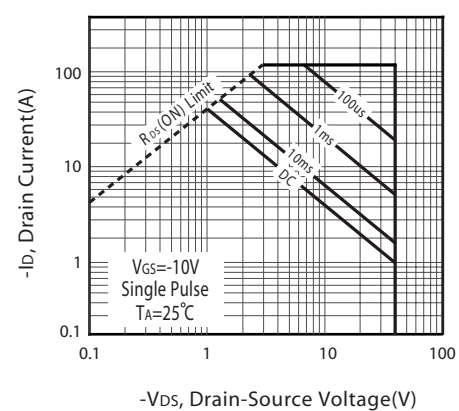
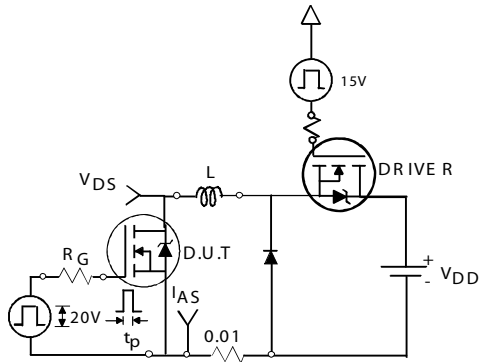
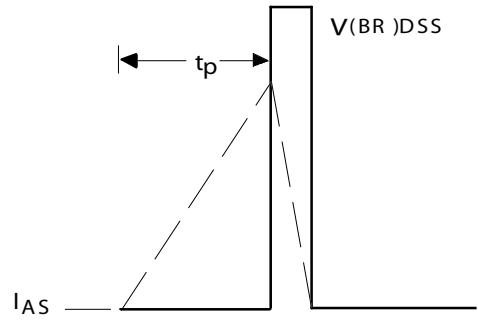

Figure 12. Maximum Safe Operating Area



Unclamped Inductive Test Circuit

Figure 13a.



Unclamped Inductive Waveforms

Figure 13b.

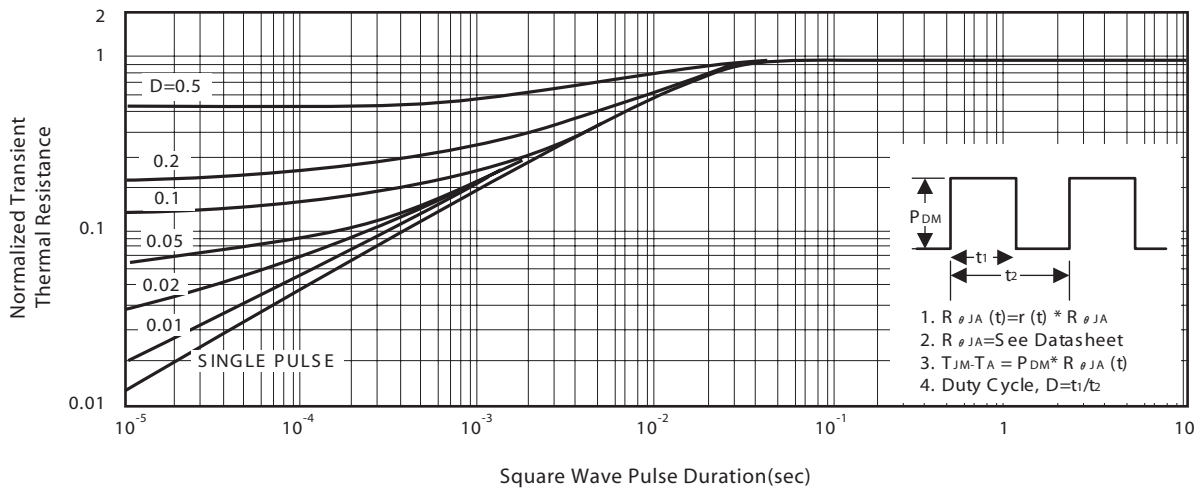
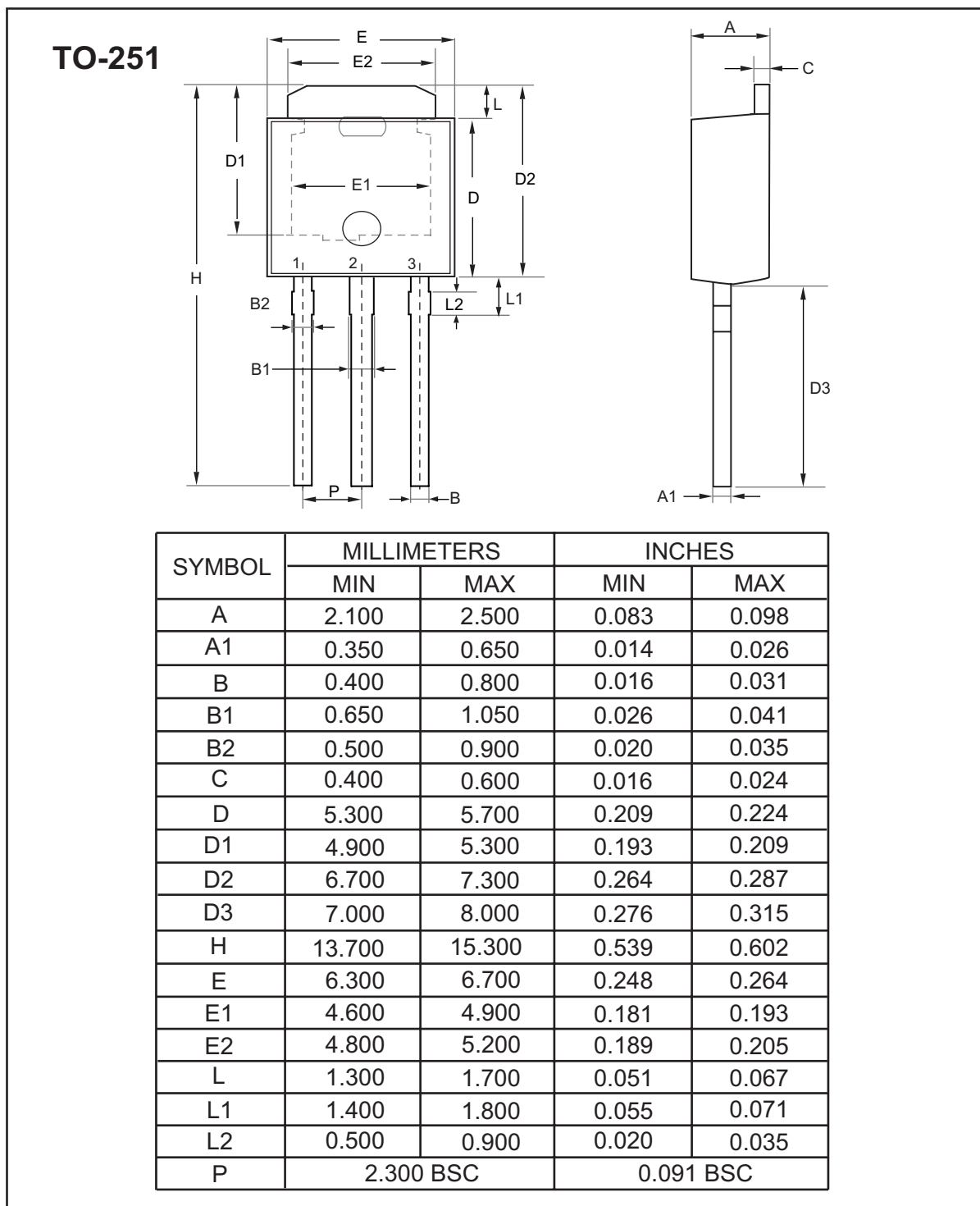

Figure 14. Normalized Thermal Transient Impedance Curve

STU/D417S

Ver 1.2

PACKAGE OUTLINE DIMENSIONS



Aug,23,2010

STU/D417S

Ver 1.2

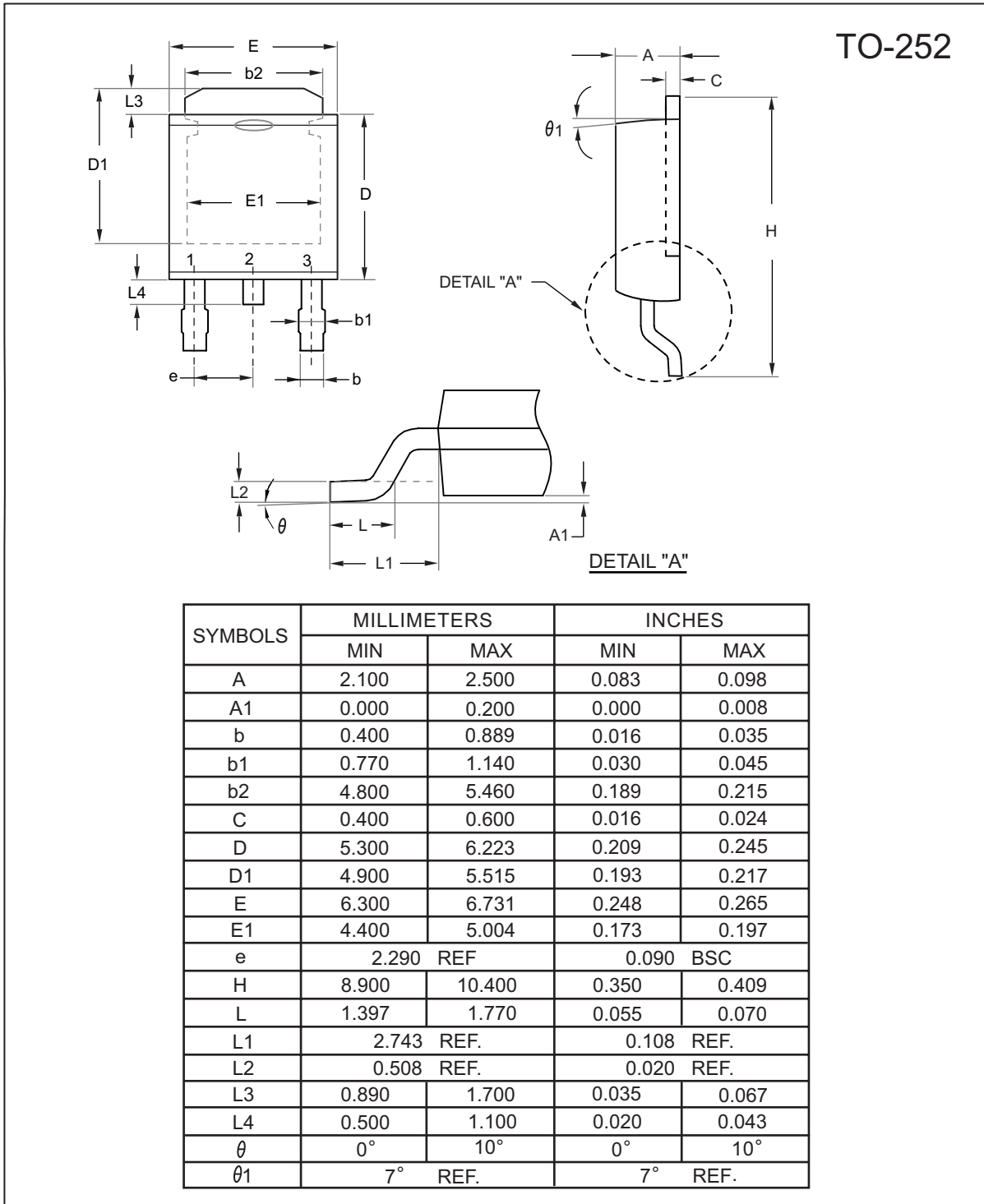

Aug,23,2010

TO-251 Tube/TO-252 Tape and Reel Data

TO-251 Tube

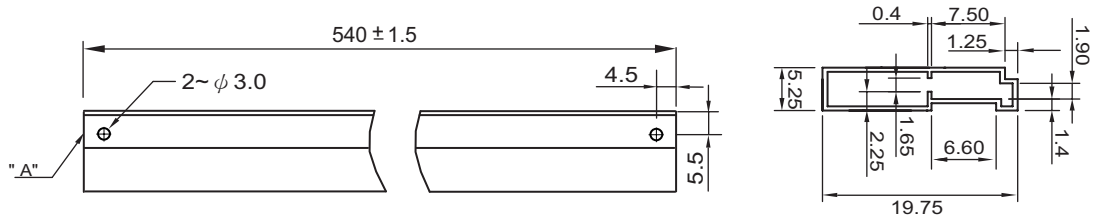

TO-252 Carrier Tape

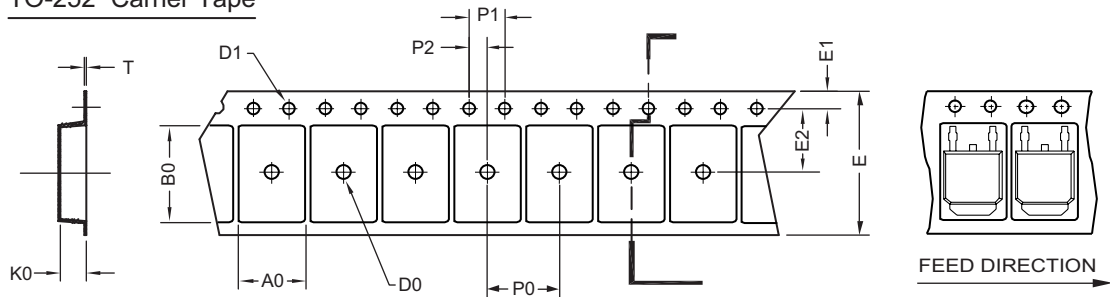

UNIT:mm

| PACKAGE | A0 | B0 | K0 | D0 | D1 | E | E1 | E2 | P0 | P1 | P2 | T |
|-------------------|--------------|---------------|--------------|-----|-----------------------|--------------|--------------|--------------|-------------|-------------|--------------|--------------|
| TO-252 (16 mm) | 6.96 ±0.1 | 10.49 ±0.1 | 2.79 ±0.1 | φ 2 | φ 1.5 + 0.1 - 0 | 16.0 ±0.3 | 1.75 ±0.1 | 7.5 ±0.15 | 8.0 ±0.1 | 4.0 ±0.1 | 2.0 ±0.15 | 0.3 ±0.05 |

TO-252 Reel

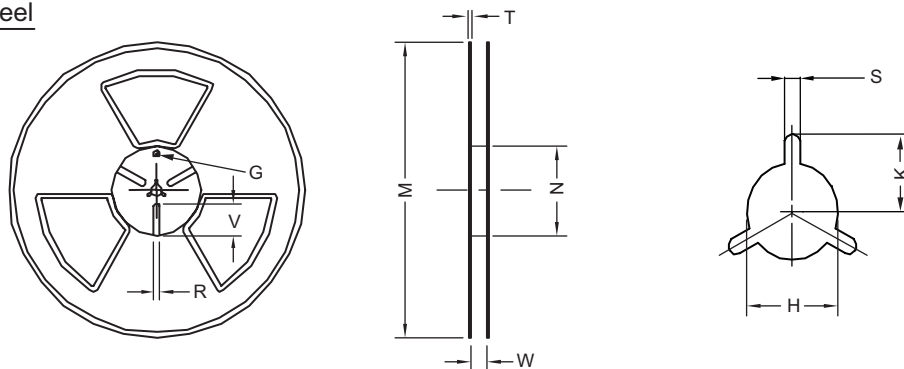

UNIT:mm

| TAPE SIZE | REEL SIZE | M | N | W | T | H | K | S | G | R | V |
|-----------|-----------|----------------|---------------|----------------------|-----|--------------------------|------|-------------|-----|-----|-----|
| 16 mm | φ 330 | φ 330 ± 0.5 | φ 97 ± 1.0 | 17.0 + 1.5 - 0 | 2.2 | φ 13.0 + 0.5 - 0.2 | 10.6 | 2.0 ±0.5 | --- | --- | --- |