



■ Absolute Maximum Ratings

Ta = 25°C

		Red	Green	Orange	Unit
		NAR / NKR	NAG / NKG	NAA / NKA	
Power Dissipation	Pb	60	63	63	mW
Forward Current	IF	30	25	25	mA
Peak Forward Current	IFM	120	100	100	mA
Reverse Voltage	VR	4	4	4	V
Operating Temp.	Topr	-40~+85	-40~+85	-40~+85	°C
Storage Temp.	Tstg	-40~+85	-40~+85	-40~+85	°C
Derating *	ΔIF	0.41	0.34	0.34	mA/°C

* The current derating for operation applies when temperature is above 25°C.

• IFM Condition : tw ≤ 1msec, Duty ≤ 1/20

■ Electro-Optical Characteristics

Ta = 25°C

Part No.		Case Color	Chip		Luminous Intensity Iv					Wavelength λp		Forward Voltage VF			Reverse Current IR	
Anode Common	Cathode Common		Material	Emitted Color	Rank B		Rank C		IF	TYP	IF	TYP	TYP	MAX	IF	MAX
NAR141	NKR141	Black	GaAlAs	Red	4	8	8	11	20	660	20	1.7	2.0	20	100	4
NAR143	NKR143	Gray			MIN	TYP	MIN	TYP	IF	TYP	IF	TYP	MAX	IF	MAX	VR
NAG141P	NKG141P	Black	GaP	Green	1	2	—	—	20	565	20	2.2	2.5	20	100	4
NAG143P	NKG143P	Gray			MIN	TYP	MIN	TYP	IF	TYP	IF	TYP	MAX	IF	MAX	VR
NAA141	NKA141	Black	GaAsP	Orange	3	6	—	—	20	605	20	2.2	2.5	20	100	4
NAA143	NKA143	Gray			MIN	TYP	MIN	TYP	IF	TYP	IF	TYP	MAX	IF	MAX	VR
Units					mcd	mcd	mcd	mcd	mA	nm	mA	V	V	mA	μA	V

■ Package Dimensions

Unit : mm

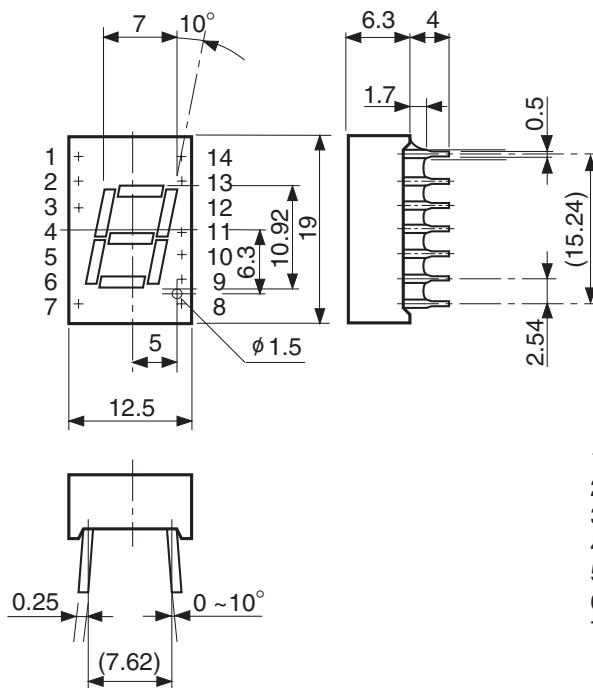

- 1. Cathode a
- 2. Cathode f
- 3. Common Anode
- 4. No Pin
- 5. No Pin
- 6. No Pin
- 7. Cathode e
- 8. Cathode d
- 9. Cathode DP
- 10. Cathode c
- 11. Cathode g
- 12. No Pin
- 13. Cathode b
- 14. Common Anode

* Leave a minimum clearance of 1.7 mm from body resin to solder.

Tolerance : ± 0.25mm



■ SUPER BRIGHT LED NUMERIC DISPLAY

NAR / NKR 141 / 143

■ Forward Voltage vs. Forward Current

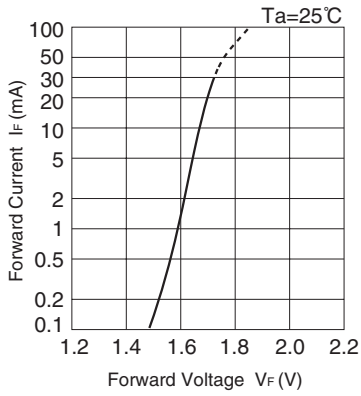

■ Ambient Temperature vs. Maximum Forward Current

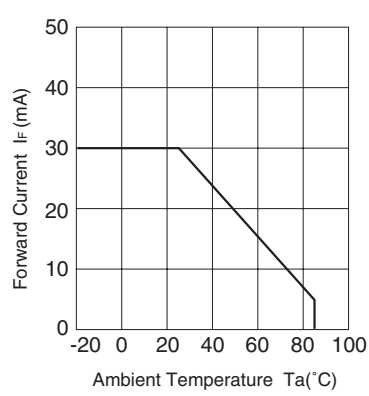

■ Forward Current vs. Relative Intensity

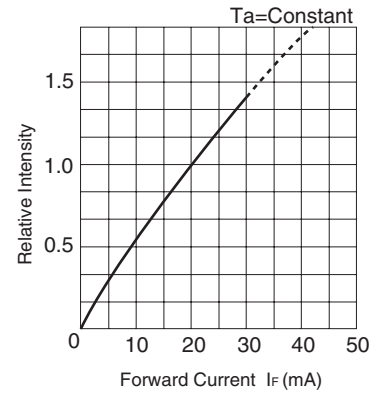

■ Duty Cycle vs. Relative Intensity

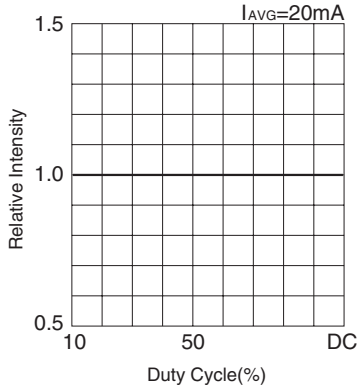

■ Duty Cycle vs. Maximum Forward Current

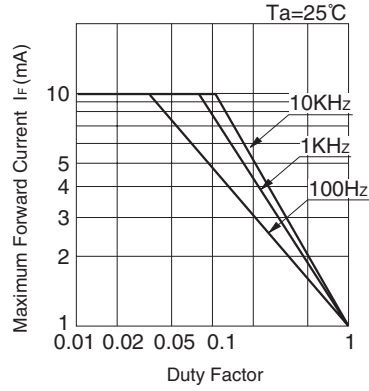

■ Forward Voltage vs. Forward Current

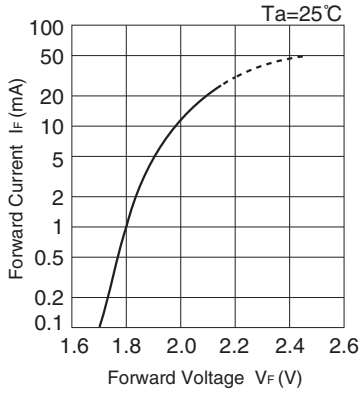

■ Ambient Temperature vs. Maximum Forward Current

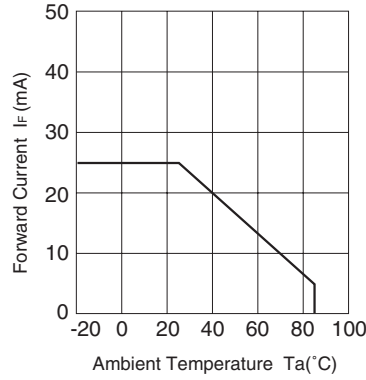

■ Forward Current vs. Relative Intensity

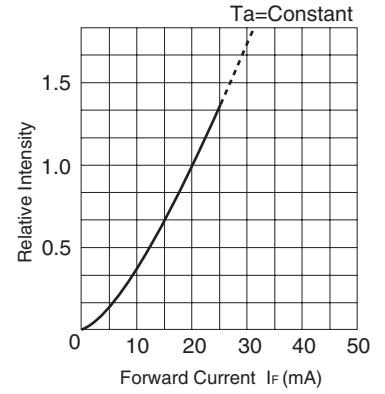

■ Duty Cycle vs. Relative Intensity

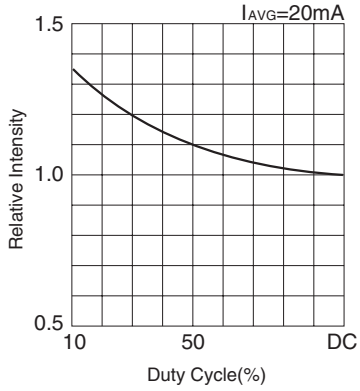

■ Duty Cycle vs. Maximum Forward Current

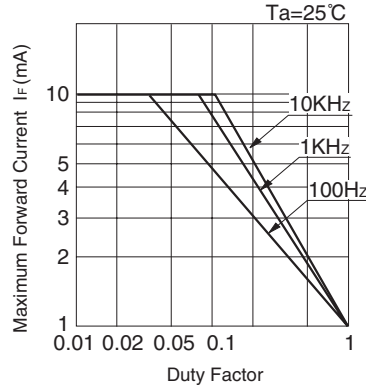

■ Forward Voltage vs. Forward Current

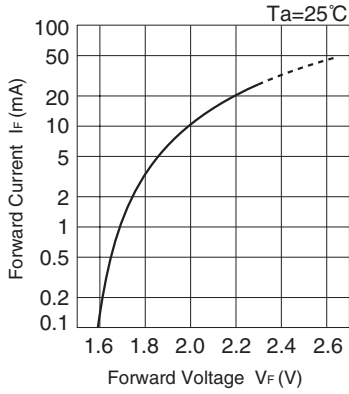

■ Ambient Temperature vs. Maximum Forward Current

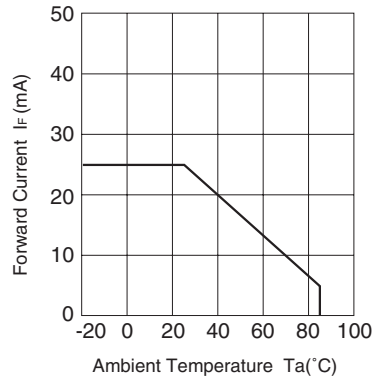

■ Forward Current vs. Relative Intensity

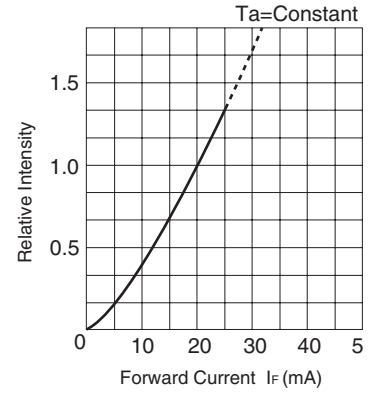

■ Duty Cycle vs. Relative Intensity

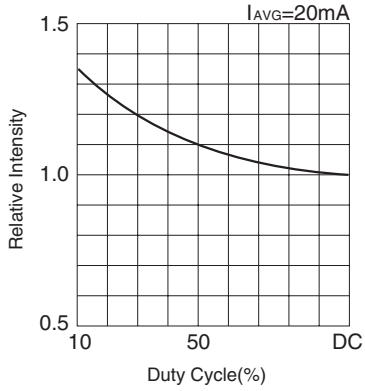

■ Duty Cycle vs. Maximum Forward Current

