

# General Purpose PNP Epitaxial Planar Transistor

## BCX53M3

### Features

- High breakdown voltage,  $BV_{CEO} \geq -80V$
- Large continuous collector current capability
- Low collector saturation voltage
- Complementary to BCX56M3
- Pb-free lead plating and halogen-free package

### Symbol

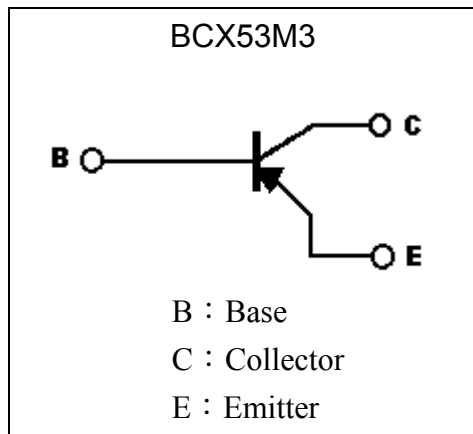

### Outline

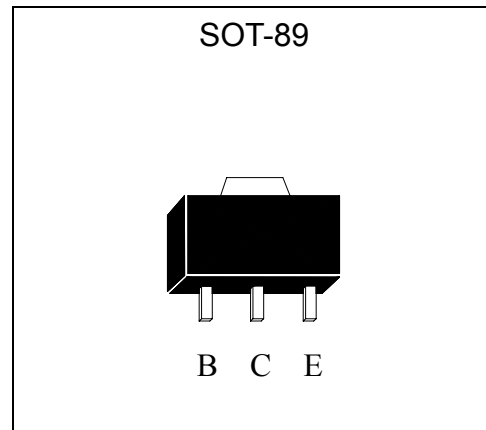

### Ordering Information

| Device          | Package   | Shipping               |
|-----------------|---|------------------------|
| BCX53M3-XX-T2-G | SOT-89<br>(Pb-free lead plating and halogen-free package) | 1000 pcs / Tape & Reel |

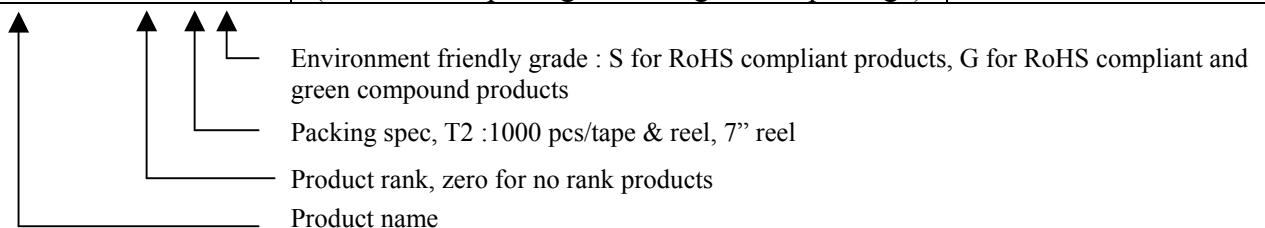



**Absolute Maximum Ratings** (Ta=25°C)

| Parameter                               | Symbol           | Limits        | Unit |
|---|------------------|---------------|------|
| Collector-Base Voltage                  | V <sub>CB0</sub> | -100          | V    |
| Collector-Emitter Voltage               | V <sub>CEO</sub> | -80           |      |
| Emitter-Base Voltage                    | V <sub>EBO</sub> | -5            |      |
| Collector Current(DC)                   | I <sub>C</sub>   | -1            | A    |
| Collector Current(Pulse)                | I <sub>CP</sub>  | -1.5          |      |
| Power Dissipation                       | Pd               | 0.6           | W    |
|   |                  | 1 (Note 1)    |      |
|   |                  | 2 (Note 2)    |      |
| Thermal Resistance, Junction to Ambient | R <sub>θJA</sub> | 208           | °C/W |
|   |                  | 83.3 (Note 1) |      |
|   |                  | 59.5 (Note 2) |      |
| Junction Temperature Range              | T <sub>j</sub>   | -55~+150      | °C   |
| Storage Temperature Range               | T <sub>stg</sub> | -55~+150      | °C   |

Note : 1. When mounted on FR-4 PCB with area measuring 10×10×1 mm  
 2 . When mounted on ceramic with area measuring 40×40×1 mm

**Characteristics** (Ta=25°C)

| Symbol                | Min. | Typ.  | Max. | Unit | Test Conditions  |
|-----------------------|------|-------|------|------|--|
| BV <sub>CB0</sub>     | -100 | -     | -    | V    | I <sub>C</sub> =-100μA                                 |
| BV <sub>CEO</sub>     | -80  | -     | -    | V    | I <sub>C</sub> =-10mA                                  |
| BV <sub>EBO</sub>     | -5   | -     | -    | V    | I <sub>E</sub> =-10μA                                  |
| I <sub>CB0</sub>      | -    | -     | -100 | nA   | V <sub>CB</sub> =-80V                                  |
| I <sub>EBO</sub>      | -    | -     | -20  | nA   | V <sub>EB</sub> =-4V                                   |
| *V <sub>CE(sat)</sub> | -    | -0.16 | -0.5 | V    | I <sub>C</sub> =-500mA, I <sub>B</sub> =-50mA          |
| *V <sub>BE(on)</sub>  | -    | -     | -1   | V    | V <sub>CE</sub> =-2V, I <sub>C</sub> =-500mA           |
| *h <sub>FE 1</sub>    | 100  | -     | -    | -    | V <sub>CE</sub> =-2V, I <sub>C</sub> =-5mA             |
| *h <sub>FE 2</sub>    | 100  | -     | 400  | -    | V <sub>CE</sub> =-2V, I <sub>C</sub> =-150mA           |
| *h <sub>FE 3</sub>    | 40   | -     | -    | -    | V <sub>CE</sub> =-2V, I <sub>C</sub> =-500mA           |
| f <sub>T</sub>        | 150  | -     | -    | MHZ  | V <sub>CE</sub> =-10V, I <sub>C</sub> =-50mA, f=100MHZ |
| Cob                   | -    | -     | 25   | pF   | V <sub>CB</sub> =-10V, I <sub>E</sub> =0A, f=1MHZ      |

\*Pulse Test: Pulse Width ≤380μs, Duty Cycle≤2%

**Classification Of hFE 2**

|       |         |         |
|-------|---------|---------|
| Rank  | 16      | 25      |
| Range | 100~250 | 160~400 |

### Characteristic Curves

Current Gain vs Collector Current

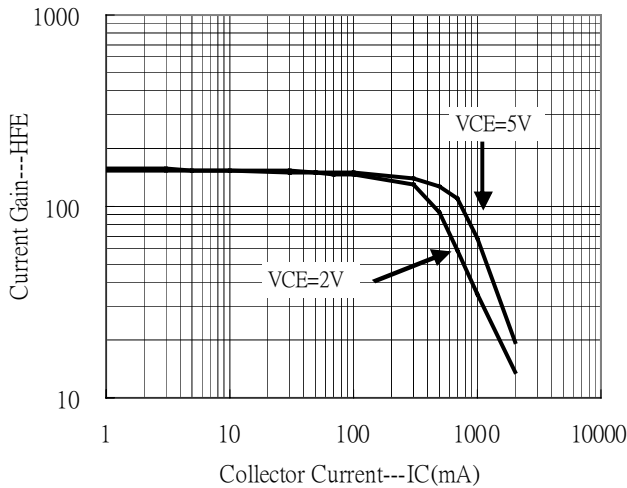

Saturation Voltage vs Collector Current

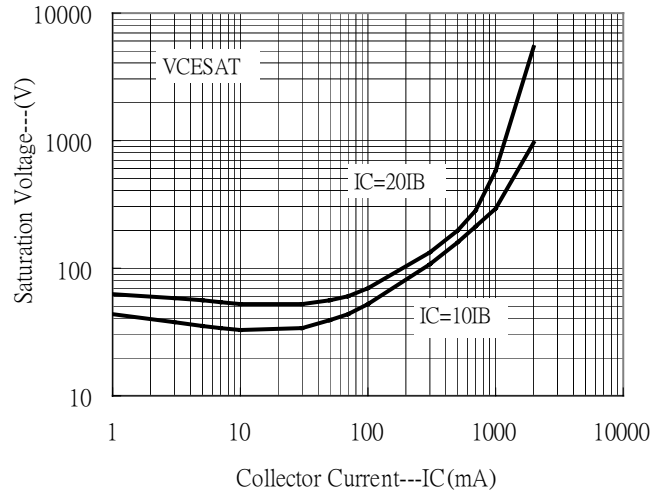

Saturation Voltage vs Collector Current

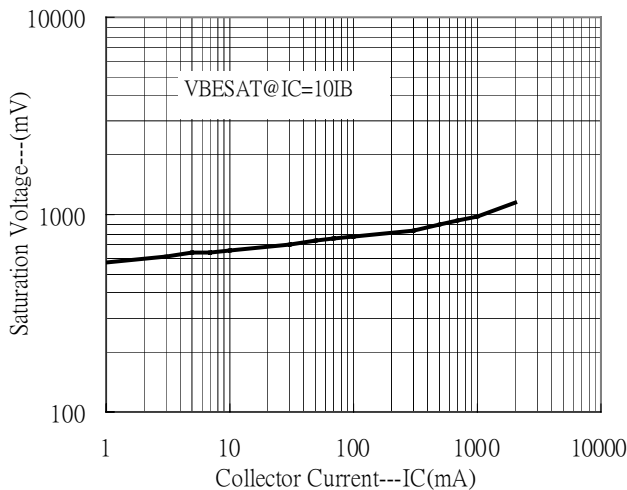

On Voltage vs Collector Current

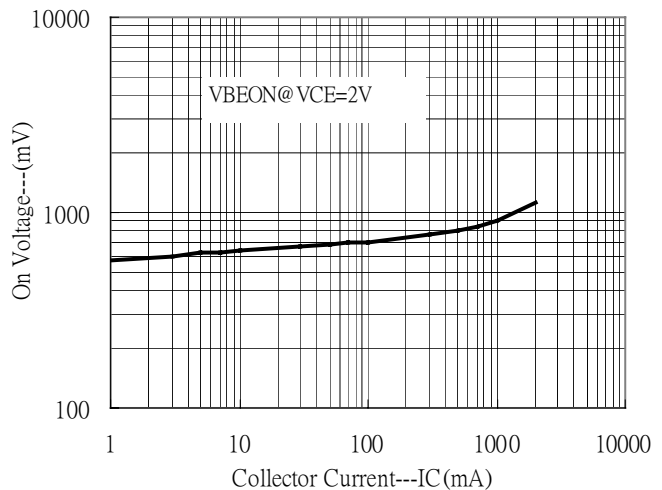

Power Derating Curves

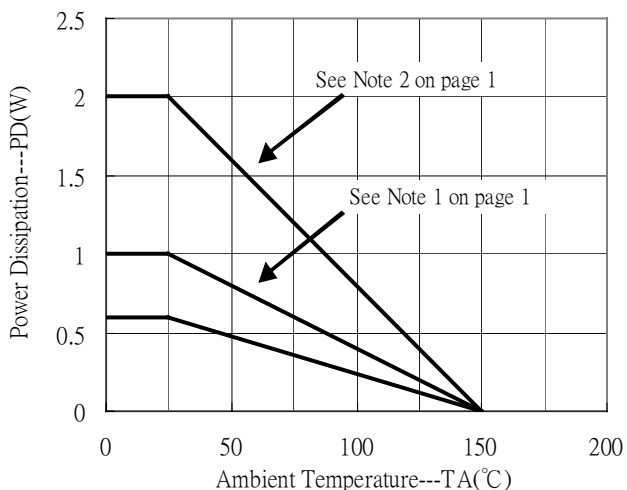



**Recommended wave soldering condition**

|                 |                  |                 |
|-----------------|------------------|-----------------|
| Product         | Peak Temperature | Soldering Time  |
| Pb-free devices | 260 +0/-5 °C     | 5 +1/-1 seconds |

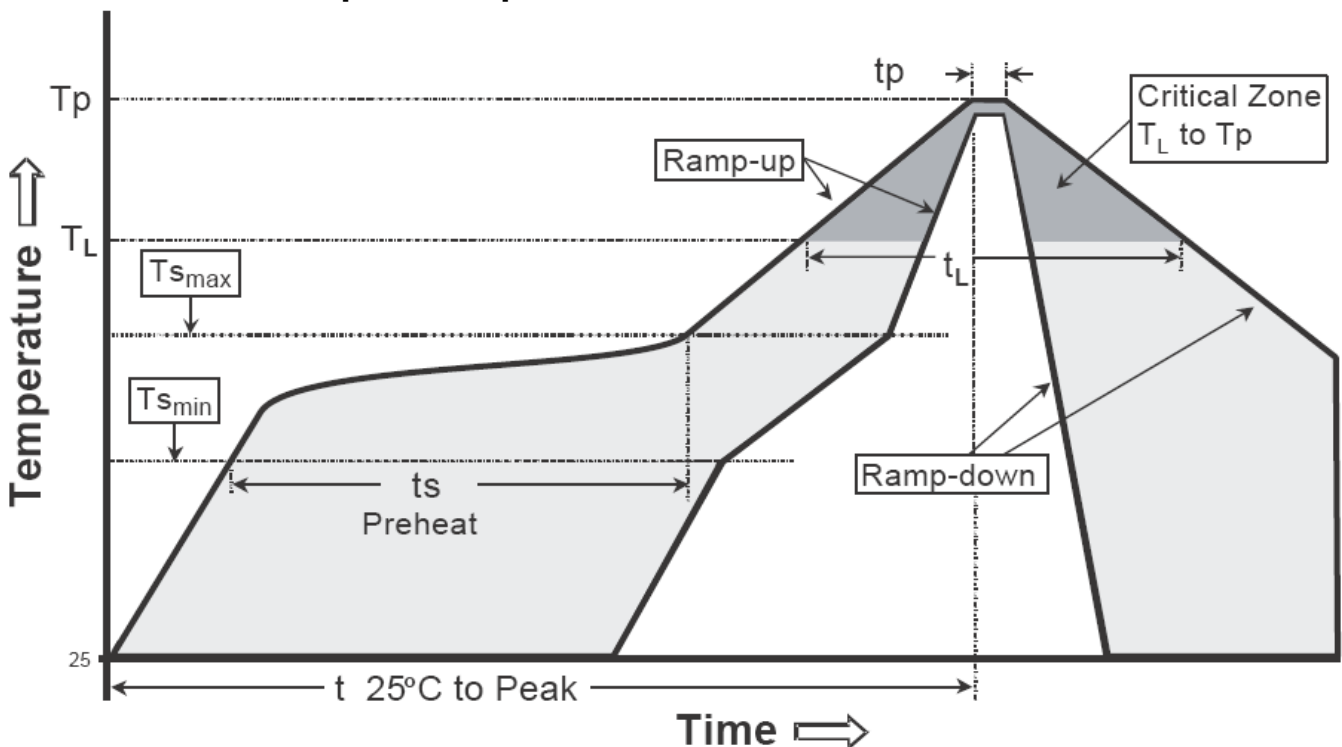
**Recommended temperature profile for IR reflow**

| Profile feature                                | Sn-Pb eutectic Assembly | Pb-free Assembly |
|--|-------------------------|------------------|
| Average ramp-up rate (Tsmax to Tp)             | 3°C/second max.         | 3°C/second max.  |
| Preheat  |                         |                  |
| -Temperature Min(Ts min)                       | 100°C                   | 150°C            |
| -Temperature Max(Ts max)                       | 150°C                   | 200°C            |
| -Time(ts min to ts max)                        | 60-120 seconds          | 60-180 seconds   |
| Time maintained above:                         |                         |                  |
| -Temperature (Tl)                              | 183°C                   | 217°C            |
| - Time (tl)                                    | 60-150 seconds          | 60-150 seconds   |
| Peak Temperature(Tp)                           | 240 +0/-5 °C            | 260 +0/-5 °C     |
| Time within 5°C of actual peak temperature(tp) | 10-30 seconds           | 20-40 seconds    |
| Ramp down rate                                 | 6°C/second max.         | 6°C/second max.  |
| Time 25 °C to peak temperature                 | 6 minutes max.          | 8 minutes max.   |

Note : All temperatures refer to topside of the package, measured on the package body surface.

**SOT-89 Dimension**

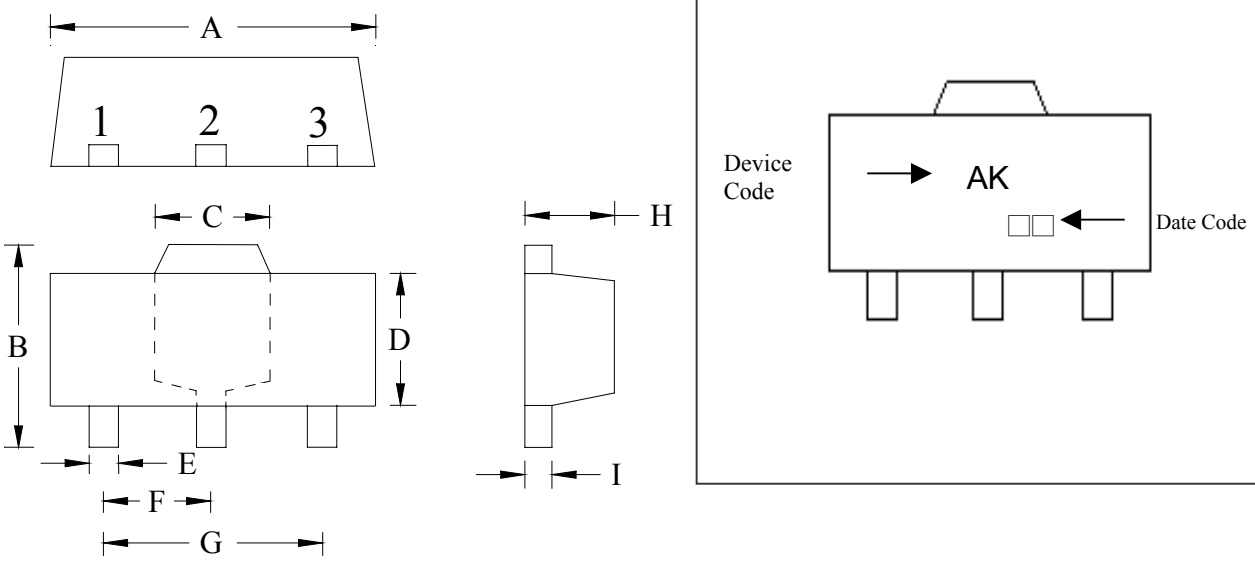

**Marking:**

Device Code → AK ← Date Code

Style: Pin 1. Base 2. Collector 3. Emitter

3-Lead SOT-89 Plastic Surface Mounted Package  
 CYStek Package Code: M3

| DIM | Inches |        | Millimeters |      | DIM | Inches |        | Millimeters |      |
|-----|--------|--------|-------------|------|-----|--------|--------|-------------|------|
|     | Min.   | Max.   | Min.        | Max. |     | Min.   | Max.   | Min.        | Max. |
| A   | 0.1732 | 0.1811 | 4.40        | 4.60 | F   | 0.0591 | TYP    | 1.50        | TYP  |
| B   | 0.1551 | 0.1673 | 3.94        | 4.25 | G   | 0.1181 | TYP    | 3.00        | TYP  |
| C   | 0.0610 | REF    | 1.55        | REF  | H   | 0.0551 | 0.0630 | 1.40        | 1.60 |
| D   | 0.0906 | 0.1024 | 2.30        | 2.60 | I   | 0.0138 | 0.0173 | 0.35        | 0.44 |
| E   | 0.0126 | 0.0205 | 0.32        | 0.52 |     |        |        |             |      |

**Notes:** 1.Controlling dimension: millimeters.  
 2.Maximum lead thickness includes lead finish thickness, and minimum lead thickness is the minimum thickness of base material.  
 3.If there is any question with packing specification or packing method, please contact your local CYStek sales office.

**Material:**

- Lead: Pure tin plated.
- Mold Compound: Epoxy resin family, flammability solid burning class: UL94V-0.

**Important Notice:**

- All rights are reserved. Reproduction in whole or in part is prohibited without the prior written approval of CYStek.
- CYStek reserves the right to make changes to its products without notice.
- CYStek **semiconductor products are not warranted to be suitable for use in Life-Support Applications, or systems.**
- CYStek assumes no liability for any consequence of customer product design, infringement of patents, or application assistance.